

SuperDiode – 6nS, 225mW, 200mA SOT-23 Plastic-Encapsulate Switching Diode

1. Features

- Fast switching device ($T_{rr} < 6ns$)
- Power dissipation of 225mW
- High stability and high reliability
- Low reverse leakage

2. Mechanical Data

- SOT-23 Small Outline Plastic Package
- Epoxy UL: 94V-0
- Mounting Position: Any

3. Marking and Circuit

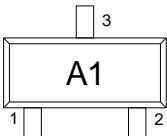
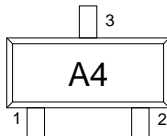
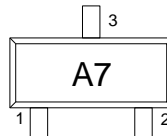
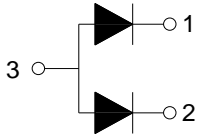
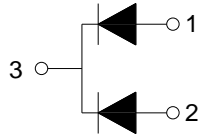
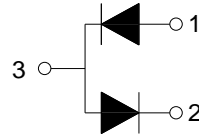
BAW56	BAV70	BAV99
		
		

4. Specification

Absolute Maximum Rating & Thermal Characteristics

Ratings at 25 °C ambient temperature unless otherwise specified.

Parameters	Symbol	Limit	Unit
Reverse voltage	VR	70	V
Power Dissipation	PD	225	mW
Operating junction temperature	Tj	150	°C
Storage temperature range	Ts	-65~150	°C
Average rectified current	IO	200	mA
Non-repetitive peak forward current	IFM	400	mA
Peak forward surge current @tp=1ms; TA=25°C	IFSM	2.0	A
Typical thermal resistance	RθJA	500	°C/W

Electrical Characteristics

At TA = 25°C unless otherwise specified

Parameter	Symbol	Conditions	Min.	Typ.	Max.	Units
Maximum forward voltage	V _F	IF=1mA			0.715	V
		IF=10mA			0.855	
		IF=50mA			1.00	
		IF=150mA			1.25	
Maximum reverse breakdown voltage	V _{RB}	IR=100uA	70			V
Maximum reverse leakage current	I _R	VR=70V			2.5	uA
Type junction capacitance	C _j	VR=1.0V, f=1MHz			1.5	pF
Reverse recovery time	T _{RR}	IF=IR=10mA Irr=0.1 x IR, RL=100Ω			6	nS

5. Typical Characteristic

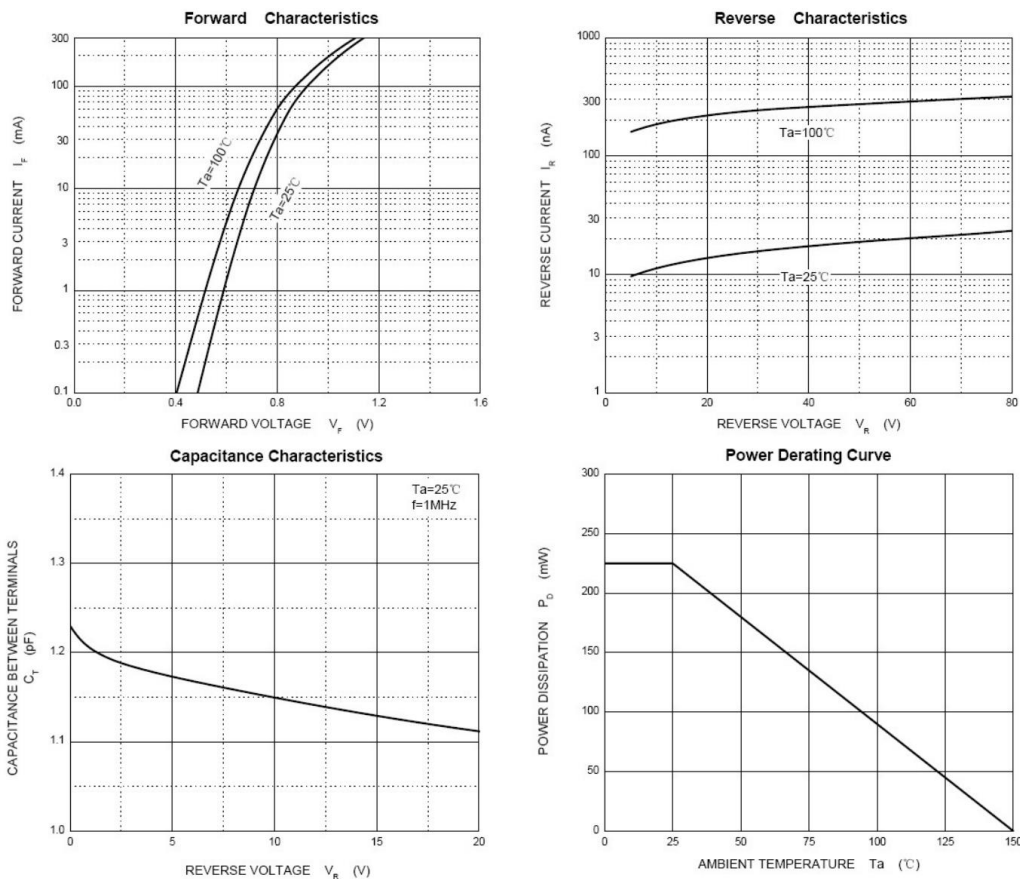

6. Dimension and Patterns (SOT-23)

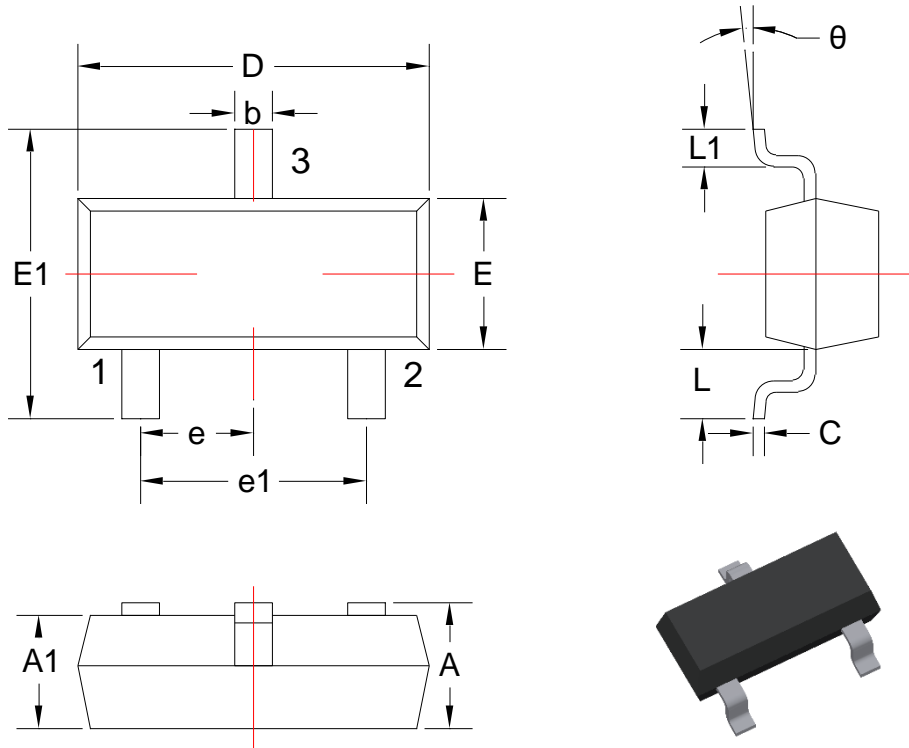

Units: mm

Symbol	Dimensions		Symbol	Dimensions	
	Min.	Max.		Min.	Max.
A	0.900	1.150	E1	2.250	2.550
A1	0.900	1.050	e	0.950TYP	
b	0.300	0.500	e1	1.800	2.000
c	0.080	0.150	L	0.550REF	
D	2.800	3.00	L1	0.300	0.500
E	1.200	1.400	theta	0°	8°

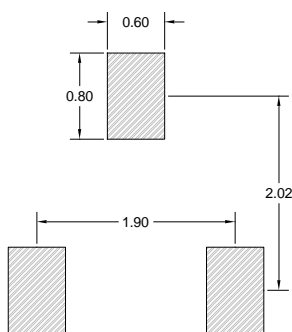

Note:

1. Controlling dimension: in millimeters
2. General tolerance: ±0.05mm
3. The pad layout is for reference only
4. Unit: mm

DISCLAIMER

ELECSUPER PROVIDES TECHNICAL AND RELIABILITY DATA (INCLUDING DATASHEETS), DESIGN RESOURCES (INCLUDING REFERENCE DESIGNS), APPLICATION OR OTHER DESIGN ADVICE, SAFETY INFORMATION, AND OTHER RESOURCES "AS IS" AND WITH ALL FAULTS, AND DISCLAIMS ALL WARRANTIES, EXPRESS AND IMPLIED, INCLUDING WITHOUT LIMITATION ANY IMPLIED WARRANTIES OF MERCHANTABILITY, FITNESS FOR A PARTICULAR PURPOSE OR NON-INFRINGEMENT OF THIRD PARTY INTELLECTUAL PROPERTY RIGHTS.

These resources are intended for skilled developers designing with ElecSuper products. You are solely responsible for

- (1) selecting the appropriate ElecSuper products for your application;
- (2) designing, validating and testing your application;
- (3) ensuring your application meets applicable standards, and any other safety, security, or other requirements.

These resources are subject to change without notice. ElecSuper grants you permission to use these resources only for development of an application that uses the ElecSuper products described in the resource. Other reproduction and display of these resources are prohibited. No license is granted to any other ElecSuper intellectual property right or to any third party intellectual property right. ElecSuper disclaims responsibility for, and you will fully indemnify ElecSuper and its representatives against, any claims, damages, costs, losses, and liabilities arising out of your use of these resources. ElecSuper's products are provided subject to ElecSuper's Terms of Sale or other applicable terms available either on www.elecsuper.com or provided in conjunction with such ElecSuper products. ElecSuper's provision of these resources does not expand or otherwise alter ElecSuper's applicable warranties or warranty disclaimers for ElecSuper products.

X-ON Electronics

Largest Supplier of Electrical and Electronic Components

Click to view similar products for [Diodes - General Purpose, Power, Switching category:](#)

Click to view products by [ElecSuper manufacturer:](#)

Other Similar products are found below :

[MMBD3004S-13-F](#) [1N3611](#) [NTE156A](#) [NTE6244](#) [1SS400CST2RA](#) [SDAA13](#) [SHN2D02FUTW1T1G](#) [1N4449](#) [1N456A](#) [1N914BTR](#)
[D291S45T](#) [BAS 16-02L E6327](#) [BAS 16-02V H6327](#) [BAS 21U E6327](#) [BAS 28 E6327](#) [BAW56DWQ-7-F](#) [BAW56M3T5G](#) [BAW75-TAP](#)
[MM230L-CAA](#) [IDW40E65D1](#) [JAN1N3600](#) [JAN1N4454UR-1](#) [SMMSD4148T3G](#) [BYW95B/A52A](#) [NSVDAN222T1G](#) [CDSZC01100-HF](#)
[BAV70HDW-7](#) [BAS28-7](#) [JANTX1N6640](#) [BAW56HDW-13](#) [BAS28 TR](#) [VS-HFA04SD60STR-M3](#) [1SS388-TP](#) [BAV99TQ-13-F](#)
[BAV99HDW-13](#) [1N4004](#) [MMDB30-E28X](#) [LS4148](#) [IDV15E65D2](#) [W0503RH200S0L](#) [M0268SJ200NLF](#) [M0268RJ200NLF](#) [S3MBF](#) [US1J](#)
[DAN217U-TP](#) [SHV-06JNS-Q](#) [IDW30C65D1](#) [IDW80C65D1](#) [VS-HFA30TA60CSR-M3](#) [M1MA152WAT1](#)