

## SuperMOS –TO-252 60V $V_{DSS}$ , 26m $\Omega$ $R_{DS(on)}$ , N-channel MOSFET

### 1. Description

The IRLR024NTRPBF-ES is N-Channel enhancement MOS Field Effect Transistor. Uses advanced technology and design to provide excellent  $R_{DS(ON)}$  with low gate charge. Device is suitable for use in DC-DC conversion, power switch and charging circuit. Standard Product IRLR024NTRPBF-ES is Pb-free.

### 2. Features

- 60V,  $R_{DS(ON)}=26m\Omega$ (TYP.) @ $V_{GS}=10V$   
 $R_{DS(ON)}=33m\Omega$ (TYP.) @ $V_{GS}=4.5V$
- High density cell design for low  $R_{DS(on)}$
- Material: Halogen free
- Reliable and rugged
- Avalanche Rated
- Low leakage current

### 3. Applications


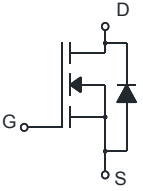
- PWM applications
- Load switch
- Power management in portable/desktop PCs
- DC/DC conversion

**100% UIS TESTED!**

### 4. Ordering Information

Part Number	Package	Marking	Material	Packing	Quantity per reel	Flammability Rating	Reel Size
IRLR024NTRPBF-ES	TO-252	ES35N06A/LOT	Halogen free	Tape & Reel	2,500 PCS	UL 94V-0	13 inches

### 5. Pin Configuration and Functions

Pin	Function	Outline	Circuit Diagram
1	Gate		
3	Source		
2	Drain		

## 6. Specification

### Absolute Maximum Rating & Thermal Characteristics

Ratings at 25 °C ambient temperature unless otherwise specified.

Parameter		Symbol	Limit	Unit
Drain-Source Voltage		$BV_{DSS}$	60	V
Gate-Source Voltage		$V_{GS}$	$\pm 20$	V
Continuous Drain Current	$T_C=25^\circ C$	$I_D$	20	A
	$T_C=75^\circ C$		16	
Maximum Power Dissipation		$P_D$	25	W
Pulsed Drain Current		$I_{DM}$	80	A
Avalanche Current, Single Pulsed <sup>a</sup>		$I_{AS}$	16	A
Avalanche Energy, Single Pulsed <sup>a</sup>		$E_{AS}$	16	mJ
Operating Junction Temperature		$T_J$	150	°C
Lead Temperature		$T_L$	260	°C
Storage Temperature Range		$T_{stg}$	-55 to 150	°C

### Thermal resistance ratings

Single Operation					
Parameter		Symbol	Typ	Max	Unit
Junction-to-Case Thermal Resistance	Steady State	$R_{\theta JC}$		5	°C/W

Note:

a:  $T_J=25^\circ C, V_{DD}=60V, V_G=10V, L=0.3mH, R_g=25\Omega$

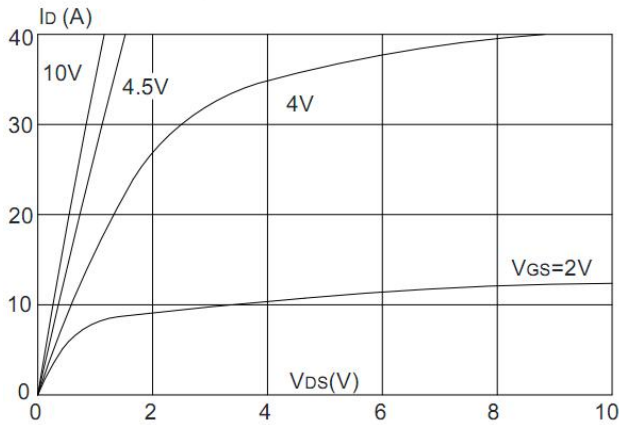
## Electrical Characteristics

At TA = 25°C unless otherwise specified

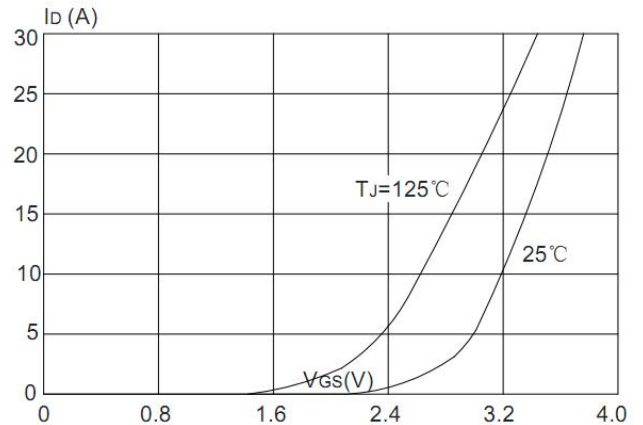
Parameter	Symbol	Test Conditions	Min.	Typ.	Max.	Unit
<b>OFF CHARACTERISTICS</b>						
Drain-to-Source Breakdown Voltage	$BV_{DSS}$	$V_{GS}=0V, I_D=250\mu A$	60			V
Zero Gate Voltage Drain Current	$I_{DSS}$	$V_{DS}=60V, V_{GS}=0V$			1.0	$\mu A$
Gate-to-source Leakage Current	$I_{GSS}$	$V_{DS}=0V, V_{GS}=\pm 20V$			$\pm 100$	nA
<b>ON CHARACTERISTICS</b>						
Gate Threshold Voltage	$V_{GS(TH)}$	$V_{GS}=V_{DS}, I_D=250\mu A$	1.0	1.6	2.5	V
Drain-to-source On-resistance	$R_{DS(on)}$	$V_{GS}=10V, I_D=20A$		26	33	m $\Omega$
		$V_{GS}=4.5V, I_D=10A$		33	45	
Forward Trans conductance	$g_{FS}$	$V_{DS}=5.0V, I_D=20A$			40	S
<b>CHARGES, CAPACITANCES AND GATE RESISTANCE</b>						
Input Capacitance	$C_{ISS}$	$V_{GS}=0V, f=1MHz, V_{DS}=25V$		860		pF
Output Capacitance	$C_{OSS}$			62		
Reverse Transfer Capacitance	$C_{RSS}$			51		
Total Gate Charge	$Q_{G(TOT)}$	$V_{GS}=10V, V_{DS}=30V, I_D=10A$		20.3		nC
Gate-to-Source Charge	$Q_{GS}$			3.8		
Gate-to-Drain Charge	$Q_{GD}$			5.5		
<b>SWITCHING CHARACTERISTICS</b>						
Turn-On Delay Time	$t_{d(ON)}$	$V_{GS}=10V, V_{DS}=30V, I_D=5A, R_G=1.8\Omega$		6		ns
Rise Time	$t_r$			6		
Turn-Off Delay Time	$t_{d(OFF)}$			19		
Fall Time	$t_f$			3		
<b>BODY DIODE CHARACTERISTICS</b>						
Forward Voltage	$V_{SD}$	$V_{GS}=0V, I_S=10A$		0.7	1.5	V

**7. Typical Characteristic**

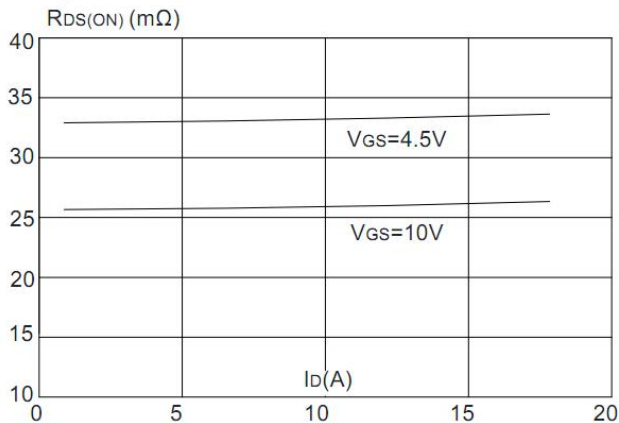
**Figure 1: Output Characteristics**



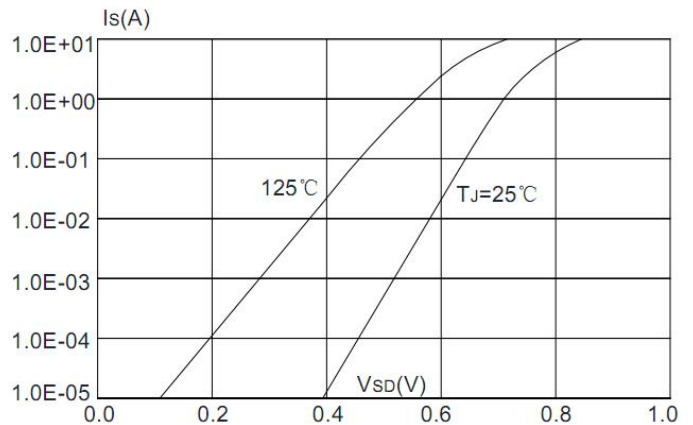
**Figure 2: Typical Transfer Characteristics**



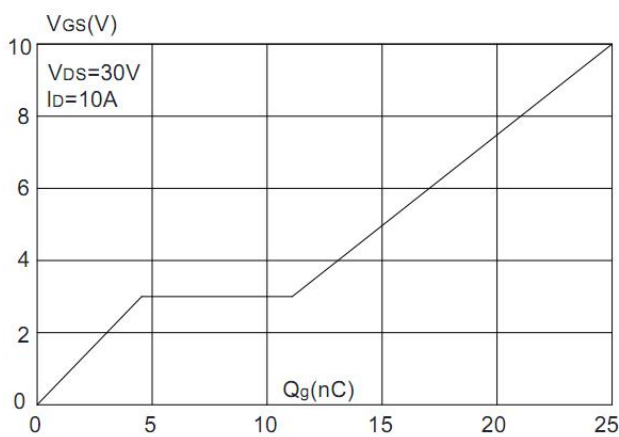
**Figure 3: On-resistance vs. Drain Current**



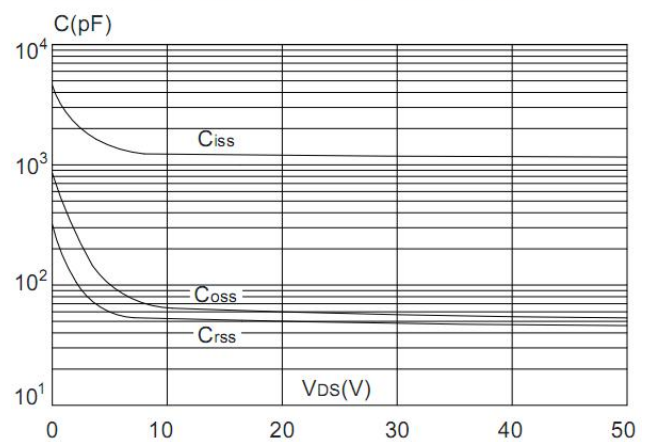
**Figure 4: Body Diode Characteristics**



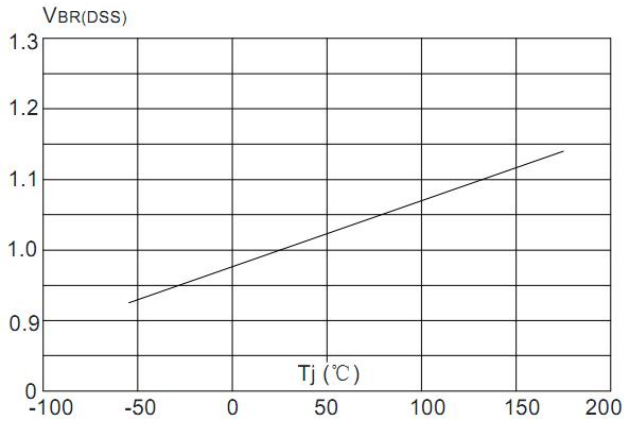
**Figure 5: Gate Charge Characteristics**



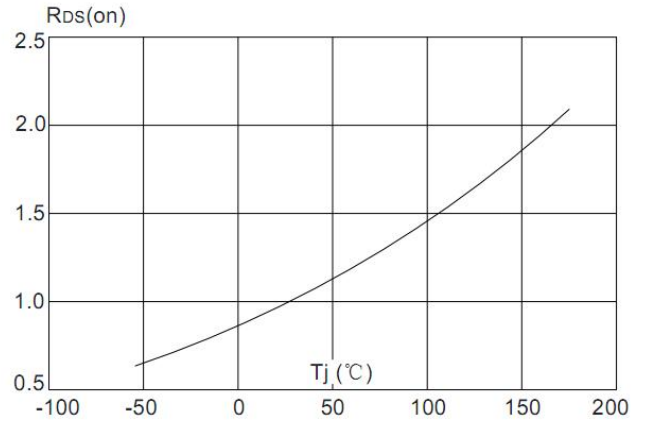
**Figure 6: Capacitance Characteristics**



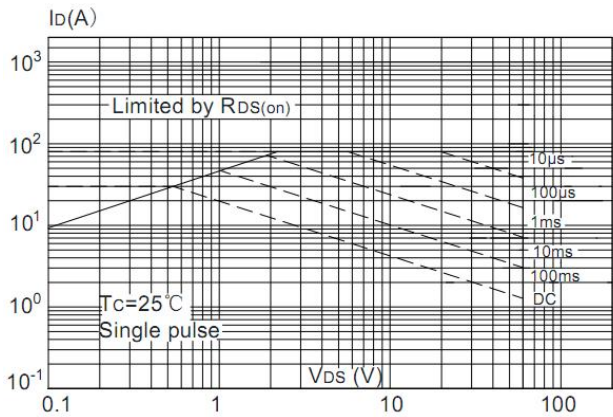
**Figure 7: Normalized Breakdown Voltage vs. Junction Temperature**



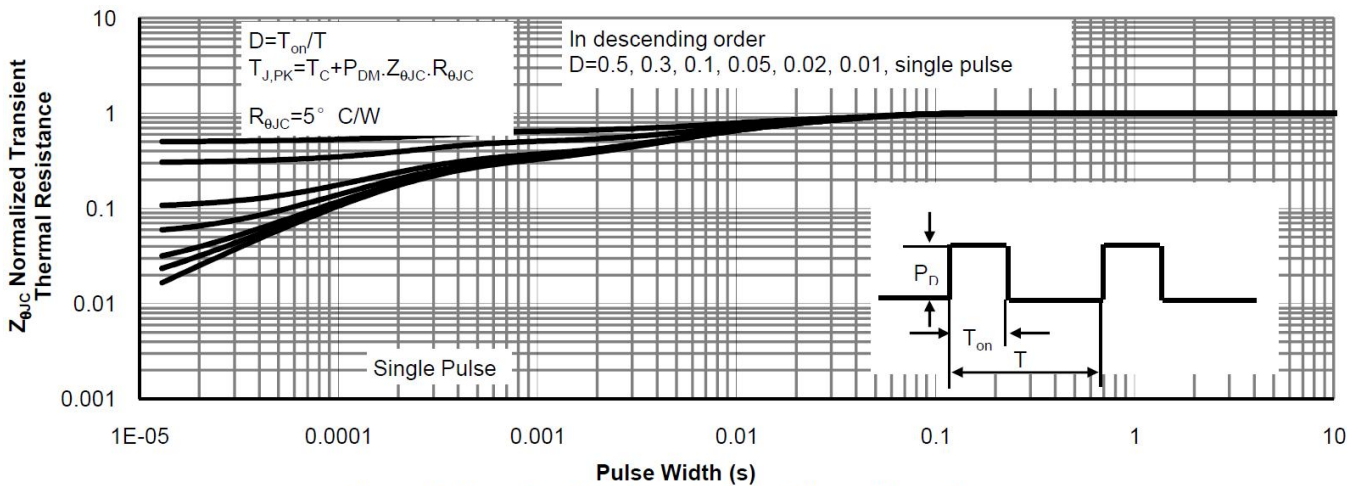
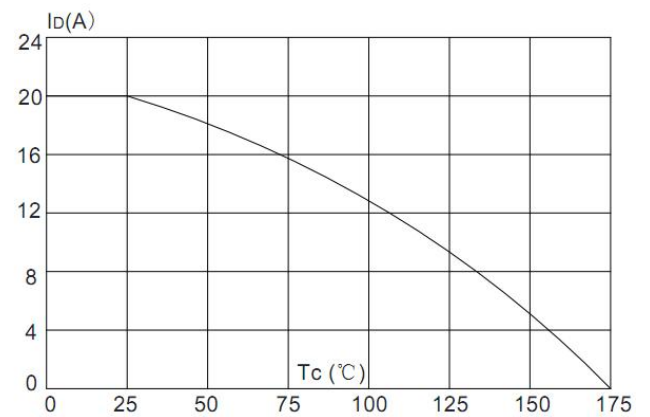
**Figure 8: Normalized on Resistance vs. Junction Temperature**



**Figure 9: Maximum Safe Operating Area**

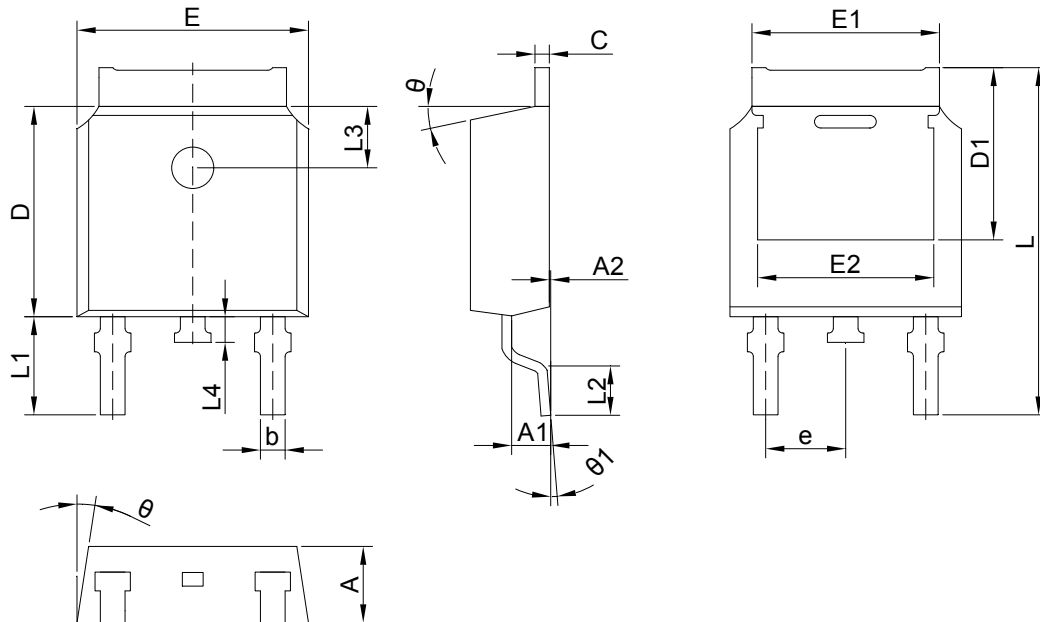


**Figure 10: Maximum Continuous Drain Current vs. Case Temperature**



**Figure 11: Normalized Maximum Transient Thermal Impedance**

8. Dimension (TO-252)



COMMON DIMENSIONS CUNITS MEASURE=MILLIMETER							
SYMBOL	MIN	TYP	MAX	SYMBOL	MIN	TYP	MAX
A	2.10	2.30	2.50	E2	4.63	4.83	5.03
A1	0.97	1.07	1.17	L	9.90	10.10	10.30
A2	0.00	-	0.12	L1	2.74	2.94	3.14
b	0.66	0.76	0.86	L2	1.40	1.50	1.70
C	0.45	0.51	0.60	L3	1.65	1.80	1.95
D	5.90	6.10	6.30	L4	0.60	0.80	1.00
D1	5.10	5.30	5.45	e	2.286 BSC		
E	6.40	6.60	6.80	theta	5°	7°	10°
E1	5.10	5.33	5.45	theta1	0°	-	3°

**DISCLAIMER**

ELECSUPER PROVIDES TECHNICAL AND RELIABILITY DATA (INCLUDING DATASHEETS), DESIGN RESOURCES (INCLUDING REFERENCE DESIGNS), APPLICATION OR OTHER DESIGN ADVICE, SAFETY INFORMATION, AND OTHER RESOURCES “AS IS” AND WITH ALL FAULTS, AND DISCLAIMS ALL WARRANTIES, EXPRESS AND IMPLIED, INCLUDING WITHOUT LIMITATION ANY IMPLIED WARRANTIES OF MERCHANTABILITY, FITNESS FOR A PARTICULAR PURPOSE OR NON-INFRINGEMENT OF THIRD PARTY INTELLECTUAL PROPERTY RIGHTS.

These resources are intended for skilled developers designing with ElecSuper products. You are solely responsible for

- (1) selecting the appropriate ElecSuper products for your application;
- (2) designing, validating and testing your application;
- (3) ensuring your application meets applicable standards, and any other safety, security, or other requirements.

These resources are subject to change without notice. ElecSuper grants you permission to use these resources only for development of an application that uses the ElecSuper products described in the resource. Other reproduction and display of these resources are prohibited. No license is granted to any other ElecSuper intellectual property right or to any third party intellectual property right. ElecSuper disclaims responsibility for, and you will fully indemnify ElecSuper and its representatives against, any claims, damages, costs, losses, and liabilities arising out of your use of these resources. ElecSuper’s products are provided subject to ElecSuper’s Terms of Sale or other applicable terms available either on [www.elecsuper.com](http://www.elecsuper.com) or provided in conjunction with such ElecSuper products. ElecSuper’s provision of these resources does not expand or otherwise alter ElecSuper’s applicable warranties or warranty disclaimers for ElecSuper products.

## X-ON Electronics

Largest Supplier of Electrical and Electronic Components

*Click to view similar products for [MOSFET](#) category:*

*Click to view products by [ElecSuper](#) manufacturer:*

Other Similar products are found below :

[IRFD120](#) [JANTX2N5237](#) [BUK455-60A/B](#) [MIC4420CM-TR](#) [VN1206L](#) [NDP4060](#) [SI4482DY](#) [IPS70R2K0CEAKMA1](#) [SQD23N06-31L-GE3](#)  
[TK16J60W,S1VQ\(O](#) [2SK2614\(TE16L1,Q\)](#) [DMN1017UCP3-7](#) [DMN1053UCP4-7](#) [SQJ469EP-T1-GE3](#) [NTE2384](#) [DMC2700UDMQ-7](#)  
[DMN2080UCB4-7](#) [DMN61D9UWQ-13](#) [US6M2GTR](#) [DMN31D5UDJ-7](#) [DMP22D4UFO-7B](#) [DMN1006UCA6-7](#) [DMN16M9UCA6-7](#)  
[STF5N65M6](#) [IRF40H233XTMA1](#) [STU5N65M6](#) [DMN6022SSD-13](#) [DMN13M9UCA6-7](#) [DMTH10H4M6SPS-13](#) [DMN2990UFB-7B](#)  
[IPB80P04P405ATMA2](#) [2N7002W-G](#) [MCAC30N06Y-TP](#) [MCQ7328-TP](#) [NTMC083NP10M5L](#) [BXP7N65D](#) [BXP4N65F](#) [AOL1454G](#)  
[WMJ80N60C4](#) [BXP2N20L](#) [BXP2N65D](#) [BXT1150N10J](#) [BXT1700P06M](#) [TSM60NB380CP](#) [ROG](#) [RQ7L055BGTGR](#) [DMNH15H110SK3-13](#)  
[SLF10N65ABV2](#) [BSO203SP](#) [BSO211P](#) [IPA60R230P6](#)