

SuperESD – LESD5ZXXT1G

1. Description

The LESD5ZXXT1G is a Transient Voltage Suppressor that designed to protect components which are connected to data and transmission lines against electrostatic discharge (ESD), electrical fast Transients (EFT), and lightning. All pins are rated to withstand 30kV ESD pulses using the IEC61000-4-2 air discharge methods.

2. Features

- IEC 61000-4-2 Level 4 ESD Protection
 - ±30kV Contact Discharge
 - ±30kV Air Discharge
- 250W Peak pulse Power (8/20us)
- RoHS compliance
- Unidirectional configuration
- Low clamping voltage
- Low leakage current
- Protects one power or I/O

3. Applications

- Portable electronics
- Control & monitoring systems
- Servers, notebooks, and desktop PCs
- Set-top box
- Communication systems
- Digital cameras

4. Ordering Information

| Part Number | Package | Material | Packing | Quantity per reel | Flammability Rating | Reel Size |
|-------------|---------|----------|-------------|-------------------|---------------------|-----------|
| LESD5ZXXT1G | SOD523 | Halogen | Tape & Reel | 3000 PCS | UL 94V-0 | 7 inches |

Table-1 Ordering information

5. Pin Configuration and Functions

| Pin | Name | Description | Outline | Circuit Diagram |
|-----|------|----------------|--|---|
| 1 | IO | Connect to IO |  |  |
| 2 | GND | Connect to GND | | |

Table-2 Pin configuration

6. Specification

6.1. Absolute Maximum rating

Over operating free-air temperature range (unless otherwise noted)

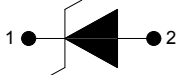
| Parameters | Symbol | Min. | Max. | Unit |
|--|------------------|------|------------------|------|
| Peak pulse power (tp=8/20us)@25°C | P _{pk} | - | 250 | W |
| Peak pulse current (tp=8/20us)@25°C | I _{PP} | - | Refer to Table-5 | A |
| ESD (IEC61000-4-2 air discharge) @25°C | V _{ESD} | - | ±30 | kV |
| ESD (IEC61000-4-2 contact discharge) @25°C | V _{ESD} | - | ±30 | kV |
| Junction temperature | T _J | - | 150 | °C |
| Operating temperature | T _{OP} | -40 | 125 | °C |
| Storage temperature | T _{STG} | -55 | 150 | °C |
| Lead temperature | T _L | - | 260 | °C |

Table-3 Absolute Maximum rating

6.2. Electrical Characteristics

| Symbol | Description |
|-----------|--|
| V_{RWM} | Rated reverse stand-off voltage |
| V_{BR} | Minimum breakdown voltage @ $I_T = 1\text{mA}$ |
| V_{CL} | Typical Clamping voltage |
| I_{PP} | Maximum peak pulse current |
| I_R | Reverse leakage current @ V_{RWM} |
| C_O | Typical line capacitance ($V_{IO}=0V$, $V_{P-P} = 30\text{mV}$, $f = 1\text{MHz}$) |

Table-4 Parameters Description

At $T_A = 25^\circ\text{C}$ unless otherwise noted

| Part Number | V_{RWM} | V_{BR} | $V_{CL}@I=1A$ | I_{PP} | $V_{CL}@I=I_{PP}$ | I_R | C_O |
|--------------|-----------|----------|---------------|----------|-------------------|-------------------|-------|
| | (V) | (V) | (V) | (A) | (V) | (μA) | (pF) |
| LESD5Z3.3T1G | 3.3 | 4.5 | 8.5 | 16.0 | 18.0 | 1.0 | 200 |
| LESD5Z5.0T1G | 5.0 | 6.5 | 9.5 | 15.0 | 20.0 | 1.0 | 180 |
| LESD5Z12T1G | 12.0 | 13.3 | 20.0 | 8.0 | 35.0 | 1.0 | 100 |
| LESD5Z15T1G | 15.0 | 16.5 | 25.0 | 6.0 | 45.0 | 1.0 | 60 |
| LESD5Z24T1G | 24.0 | 26.0 | 40.0 | 4.0 | 55.0 | 1.0 | 40 |

Table-5 Electrical Characteristics for All Series

7. Typical Characteristic

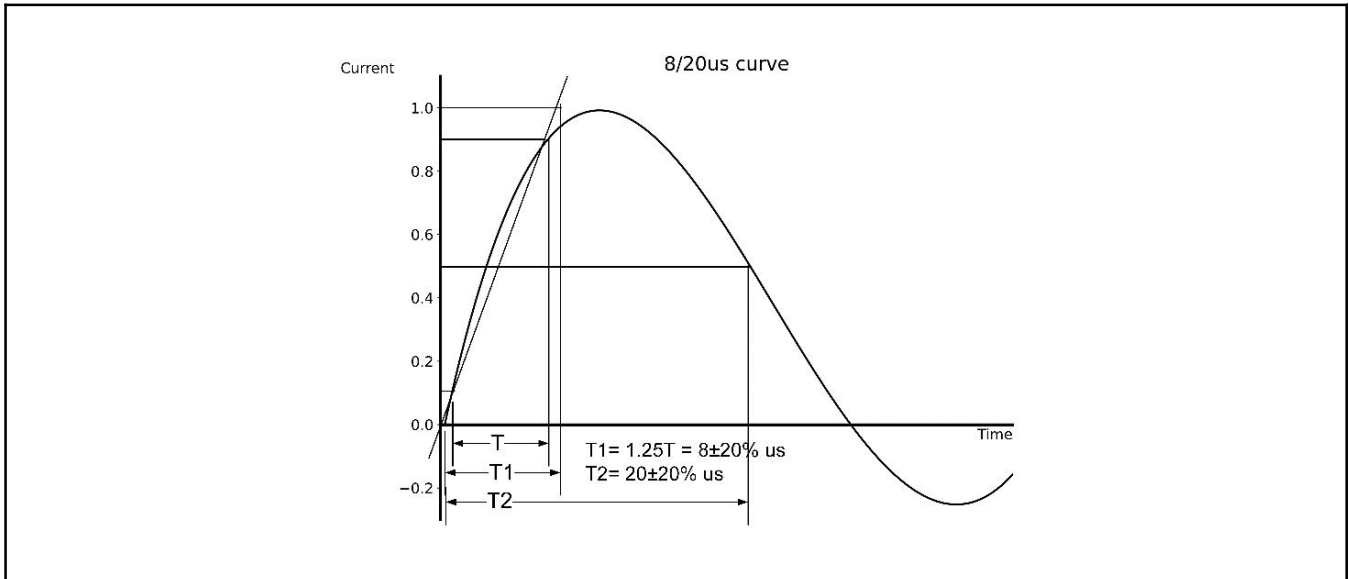

8. Typical Application

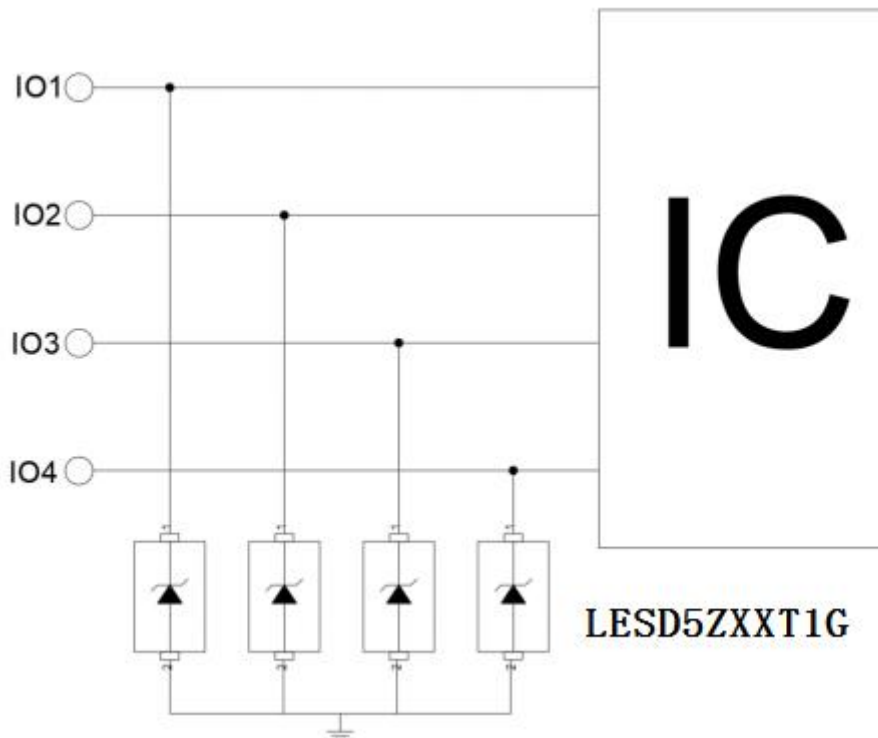

Pic-3 Typical Internet 1G Interface Application

9. Dimension

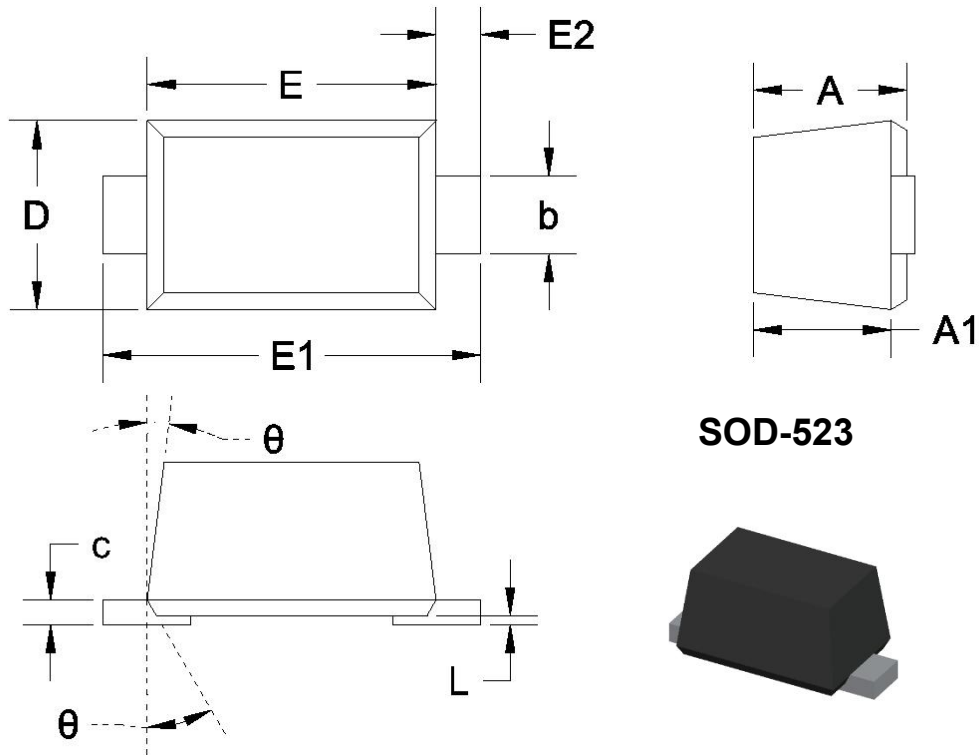

SOD-523

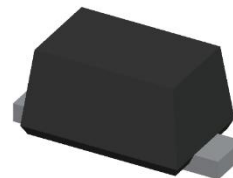

Units: Millimeters

| Unit | A | A1 | b | c | D | E | E1 | E2 | L | θ |
|------|------|------|------|------|-------|------|------|------|------|------|
| Max. | 0.77 | 0.70 | 0.35 | 0.15 | 0.125 | 1.30 | 1.70 | 0.20 | 0.07 | 7° |
| Min. | 0.51 | 0.50 | 0.25 | 0.08 | 0.75 | 1.10 | 1.50 | REF. | 0.01 | REF. |

Table-6 product dimensions

10. Recommended Land Pattern

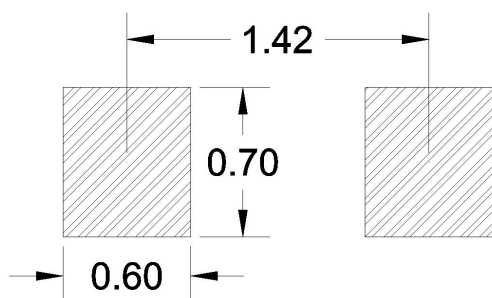

Note:

1. Controlling dimension: in millimeters
2. General tolerance: $\pm 0.05\text{mm}$

3. The pad layout is for reference only

DISCLAIMER

ELECSUPER PROVIDES TECHNICAL AND RELIABILITY DATA (INCLUDING DATASHEETS), DESIGN RESOURCES (INCLUDING REFERENCE DESIGNS), APPLICATION OR OTHER DESIGN ADVICE, SAFETY INFORMATION, AND OTHER RESOURCES “AS IS” AND WITH ALL FAULTS, AND DISCLAIMS ALL WARRANTIES, EXPRESS AND IMPLIED, INCLUDING WITHOUT LIMITATION ANY IMPLIED WARRANTIES OF MERCHANTABILITY, FITNESS FOR A PARTICULAR PURPOSE OR NON-INFRINGEMENT OF THIRD PARTY INTELLECTUAL PROPERTY RIGHTS.

These resources are intended for skilled developers designing with ElecSuper products. You are solely responsible for

- (1) selecting the appropriate ElecSuper products for your application;
- (2) designing, validating and testing your application;
- (3) ensuring your application meets applicable standards, and any other safety, security, or other requirements.

These resources are subject to change without notice. ElecSuper grants you permission to use these resources only for development of an application that uses the ElecSuper products described in the resource. Other reproduction and display of these resources are prohibited. No license is granted to any other ElecSuper intellectual property right or to any third party intellectual property right. ElecSuper disclaims responsibility for, and you will fully indemnify ElecSuper and its representatives against, any claims, damages, costs, losses, and liabilities arising out of your use of these resources. ElecSuper's products are provided subject to ElecSuper's Terms of Sale or other applicable terms available either on www.elecsuper.com or provided in conjunction with such ElecSuper products. ElecSuper's provision of these resources does not expand or otherwise alter ElecSuper's applicable warranties or warranty disclaimers for ElecSuper products.

X-ON Electronics

Largest Supplier of Electrical and Electronic Components

Click to view similar products for [ESD Suppressors / TVS Diodes](#) category:

Click to view products by [ElecSuper](#) manufacturer:

Other Similar products are found below :

[60KS200C](#) [D18V0L1B2LP-7B](#) [D5V0F4U5P5-7](#) [NTE4902](#) [P4KE27CA](#) [P6KE11CA](#) [P6KE8.2A](#) [SA60CA](#) [SA64CA](#) [SMBJ12CATR](#)
[SMBJ33CATR](#) [SMBJ6.5A](#) [SMBJ8.0A](#) [ESD101-B1-02ELS E6327](#) [ESD112-B1-02EL E6327](#) [ESD7451N2T5G](#) [19180-510](#) [CPDT-5V0USP-](#)
[HF](#) [3.0SMCJ33CA-F](#) [3.0SMCJ36A-F](#) [HSPC16701B02TP](#) [JANTX1N6126A](#) [D3V3Q1B2DLP3-7](#) [D55V0M1B2WS-7](#) [SCM1293A-04SO](#)
[ESD200-B1-CSP0201 E6327](#) [SM12-7](#) [CEN955 W/DATA](#) [VESD12A1A-HD1-GS08](#) [CPDQC5V0-HF](#) [D1213A-01LP4-7B](#) [ESD101-B1-02EL](#)
[E6327](#) [AOZ8808DI-03](#) [5KP15A](#) [5KP48A](#) [5KP90A](#) [ESD3V3D7-TP](#) [15KPA36A-LF](#) [P4KE56CA](#) [P4KE68A](#) [P4KE91CATR](#) [P6KE120A](#)
[P6KE13CA](#) [P6KE43CA](#) [P6KE6.8CA](#) [P6KE8.2](#) [P6SMBJ20CA](#) [JANTX1N6072A](#) [SR2835ESKG](#) [SA90CA](#)