

SuperTVS – 1500W Transient Voltage Suppressor

1. Features

- For surface mounted applications in order to optimize board space
- Low profile package
- Built-in strain relief
- Glass passivated junction
- Low inductance
- Excellent clamping capability
- Meets MSL level 1, per J-STD-020
- 1500W peak pulse power capability at 10/1000µs waveform, repetition rate (duty cycle): 0.01%
- Fast response time
- Typical IR less than 1µA above 10V
- Plastic package has underwriters laboratory flammability 94V-0
- High Temperature soldering: 260°C/10 seconds at terminals

2. Mechanical Data

- Case: JEDEC DO-214AB. Molded plastic over glass passivated junction
- Terminal: Solder plated, solderable per MIL-STD-750, Method 2026
- Polarity: Color band denotes cathode except bi-directional models
- Standard Packaging: 12mm tape
- Weight: 0.26g

3. Maximum Ratings and Characteristics

Ratings at 25° ambient temperature unless otherwise specified

Rating	Symbol	Value	Units
Peak pulse power dissipation at 10/1000us waveform(Note1,2)	P _{PPM}	1500	W
Peak pulse current of at 10/1000us waveform(Note1)	I _{PPM}	See Table	A
Steady state power dissipation at TA=50°C	P _{M(AV)}	6.5	W
Peak forward surge current, 8.3ms single half sine-wave superimposed on rated load (JEDEC Method)(Note3)	I _{FSM}	200	A
Operating junction and Storage Temperature Range	T _J , T _{STG}	-65 to 150	°C
Typical thermal resistance junction to lead	R _{θJL}	15	°C/W
Typical thermal resistance junction to ambient	R _{θJA}	75	°C/W

SMCJ SERIES

Rev-1.1

Notes:

1. Non-repetitive current pulse, per Fig.3 and derated above $T_A=25^{\circ}\text{C}$ per Fig.2.
2. Mounted on 8.0mm×8.0mm copper pads to each terminal.
3. 8.3ms single half sine-wave, or equivalent square wave, duty cycle=4 pulses per minutes maximum.

4. Electrical Characteristics ($T_A=25^{\circ}\text{C}$)

Part Number	Part Number	Marking		Reverse Stand off Voltage V_R	Breakdown Voltage V_{BR} (Volts) @ I_T		Test Current I_T	Maximum Clamping Voltage V_C @ I_{PP}	Maximum Peak Pulse Current I_{PP}	Maximum Reverse Leakage I_R @ V_R	ROHS2.0
					MIN	MAX					
UNI	BI	UNI	BI	(V)			(mA)	(V)	(A)	(μA)	
SMCJ5.0A	SMCJ5.0CA	GDE	BDE	5	6.4	7	10	9.2	163	400	y
SMCJ6.0A	SMCJ6.0CA	GDG	BDG	6	6.67	7.37	10	10.3	145.7	400	y
SMCJ6.5A	SMCJ6.5CA	GDK	BDK	6.5	7.22	7.98	10	11.2	134	250	y
SMCJ7.0A	SMCJ7.0CA	GDM	BDM	7	7.78	8.6	10	12	125	100	y
SMCJ7.5A	SMCJ7.5CA	GDP	BDP	7.5	8.33	9.21	1	12.9	116.3	80	y
SMCJ8.0A	SMCJ8.0CA	GDR	BDR	8	8.89	9.83	1	13.6	110.3	50	y
SMCJ8.5A	SMCJ8.5CA	GDT	BDT	8.5	9.44	10.4	1	14.4	104.2	20	y
SMCJ9.0A	SMCJ9.0CA	GDV	BDV	9	10	11.1	1	15.4	97.4	10	y
SMCJ10A	SMCJ10CA	GDX	BDX	10	11	12.3	1	17	88.3	5	y
SMCJ11A	SMCJ11CA	GDZ	BDZ	11	12.2	13.5	1	18.2	82.5	1	y
SMCJ12A	SMCJ12CA	GEE	BEE	12	13.3	14.7	1	19.9	75.4	1	y
SMCJ13A	SMCJ13CA	GEG	BEG	13	14.4	15.9	1	21.5	69.8	1	y
SMCJ14A	SMCJ14CA	GEK	BEK	14	15.6	17.2	1	23.2	64.7	1	y
SMCJ15A	SMCJ15CA	GEM	BEM	15	16.7	18.5	1	24.4	61.5	1	y
SMCJ16A	SMCJ16CA	GEP	BEP	16	17.8	19.7	1	26	57.7	1	y
SMCJ17A	SMCJ17CA	GER	BER	17	18.9	20.9	1	27.6	54.4	1	y
SMCJ18A	SMCJ18CA	GET	BET	18	20	22.1	1	29.2	51.4	1	y
SMCJ20A	SMCJ20CA	GEV	BEV	20	22.2	24.5	1	32.4	46.3	1	y
SMCJ22A	SMCJ22CA	GEX	BEX	22	24.4	26.9	1	35.5	42.3	1	y
SMCJ24A	SMCJ24CA	GEZ	BEZ	24	26.7	29.5	1	38.9	38.6	1	y
SMCJ26A	SMCJ26CA	GFE	BFE	26	28.9	31.9	1	42.1	35.7	1	y
SMCJ28A	SMCJ28CA	GFG	BFG	28	31.1	34.4	1	45.4	33.1	1	y
SMCJ30A	SMCJ30CA	GFK	BFK	30	33.3	36.8	1	48.4	31	1	y
SMCJ33A	SMCJ33CA	GFM	BFM	33	36.7	40.6	1	53.3	28.2	1	y
SMCJ36A	SMCJ36CA	GFP	BFP	36	40	44.2	1	58.1	25.9	1	y
SMCJ40A	SMCJ40CA	GFR	BFR	40	44.4	49.1	1	64.5	23.3	1	y
SMCJ43A	SMCJ43CA	GFT	BFT	43	47.8	52.8	1	69.4	21.7	1	y

SMCJ SERIES

Rev-1.1

Part Number	Part Number	Marking		Reverse Stand off Voltage V_R	Breakdown Voltage V_{BR} (Volts) @ I_R		Test Current I_R	Maximum Clamping Voltage V_C @ I_{PP}	Maximum Peak Pulse Current I_{PP}	Maximum Reverse Leakage I_R @ V_R	ROHS2.0
					MIN	MAX					
UNI	BI	UNI	BI	(V)			(mA)	(V)	(A)	(μ A)	
SMCJ45A	SMCJ45CA	GFV	BFV	45	50	55.3	1	72.7	20.6	1	y
SMCJ48A	SMCJ48CA	GFX	BFX	48	53.3	58.9	1	77.4	19.4	1	y
SMCJ51A	SMCJ51CA	GFZ	BFZ	51	56.7	62.7	1	82.4	18.2	1	y
SMCJ54A	SMCJ54CA	GGE	BGE	54	60	66.3	1	87.1	17.3	1	y
SMCJ58A	SMCJ58CA	GGG	BGG	58	64.4	71.2	1	93.6	16.1	1	y
SMCJ60A	SMCJ60CA	GGK	BGK	60	66.7	73.7	1	96.8	15.5	1	y
SMCJ64A	SMCJ64CA	GGM	BGM	64	71.1	78.6	1	103	14.6	1	y
SMCJ70A	SMCJ70CA	GGP	BGP	70	77.8	86	1	113	13.3	1	y
SMCJ75A	SMCJ75CA	GGR	BGR	75	83.3	92.1	1	121	12.4	1	y
SMCJ78A	SMCJ78CA	GGT	BGT	78	86.7	95.8	1	126	11.9	1	y
SMCJ85A	SMCJ85CA	GGV	BGV	85	94.4	104	1	137	11	1	y
SMCJ90A	SMCJ90CA	GGX	BGX	90	100	111	1	146	10.3	1	y
SMCJ100A	SMCJ100CA	GGZ	BGZ	100	111	123	1	162	9.3	1	y
SMCJ110A	SMCJ110CA	GHE	BHE	110	122	135	1	177	8.5	1	y
SMCJ120A	SMCJ120CA	GHG	BHG	120	133	147	1	193	7.8	1	y
SMCJ130A	SMCJ130CA	GHK	BHK	130	144	159	1	209	7.2	1	y
SMCJ150A	SMCJ150CA	GHM	BHM	150	167	185	1	243	6.2	1	y
SMCJ160A	SMCJ160CA	GHP	BHP	160	178	197	1	259	5.8	1	y
SMCJ170A	SMCJ170CA	GHR	BHR	170	189	209	1	275	5.5	1	y
SMCJ180A	SMCJ180CA	GHT	BHT	180	201	222	1	292	5.1	1	y
SMCJ200A	SMCJ200CA	GHV	BHV	200	224	247	1	324	4.6	1	y
SMCJ220A	SMCJ220CA	GHX	BHX	220	246	272	1	356	4.2	1	y
SMCJ250A	SMCJ250CA	GHZ	BHZ	250	279	309	1	405	3.7	1	y
SMCJ300A	SMCJ300CA	GJE	BJE	300	335	371	1	486	3.1	1	y
SMCJ350A	SMCJ350CA	GJG	BJG	350	391	432	1	567	2.6	1	y
SMCJ400A	SMCJ400CA	GJK	BJK	400	447	494	1	648	2.3	1	y
SMCJ440A	SMCJ440CA	GJM	BJM	440	492	543	1	713	2.1	1	y

For bidirectional type having V_R of 10 volts and less, the I_R limit is double.

5. Ratings and Characteristic Curves (TA =25°C unless otherwise noted)

Figure 1. Peak Pulse Power Rating Curve

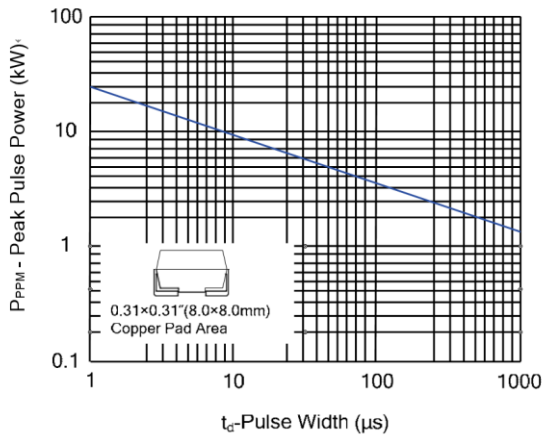

Figure 2 Pulse Derating Curve

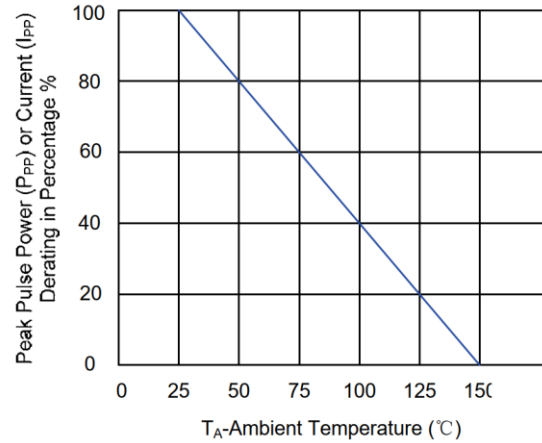

Figure 3 Pulse Waveform

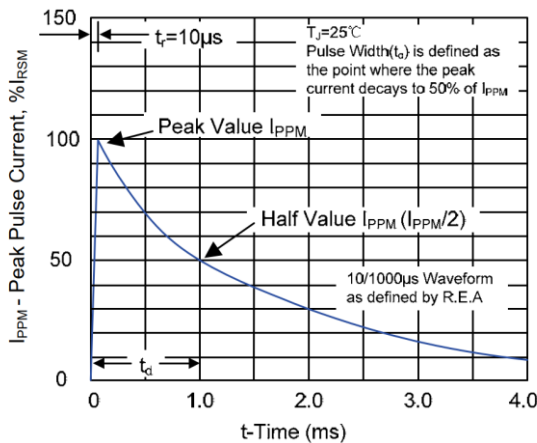

Figure 4 Typical Junction Capacitance

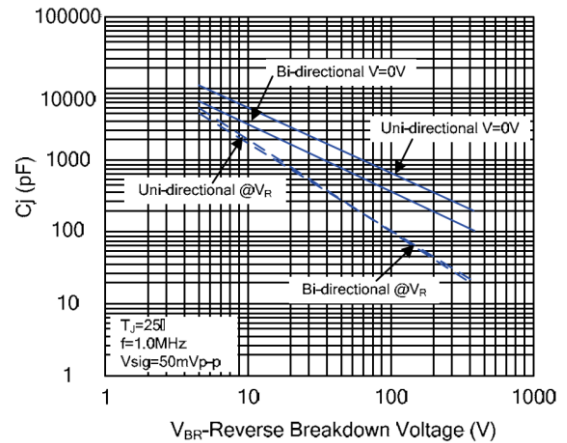

Figure 5 Steady State Power Dissipation Derating Curve

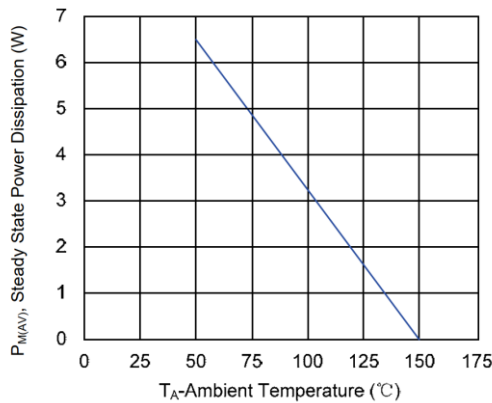
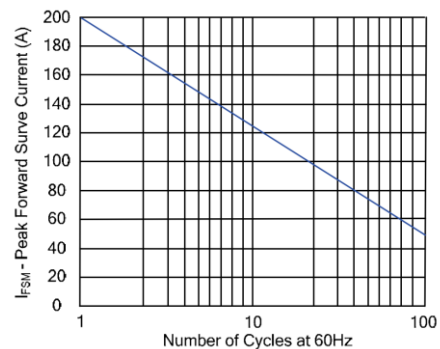

Figure 6 Maximum Non-Repetitive Forward Surge Current
Uni-Directional Only



SMCJ SERIES

Rev-1.1

6. Dimension (SMC/DO-214AB)

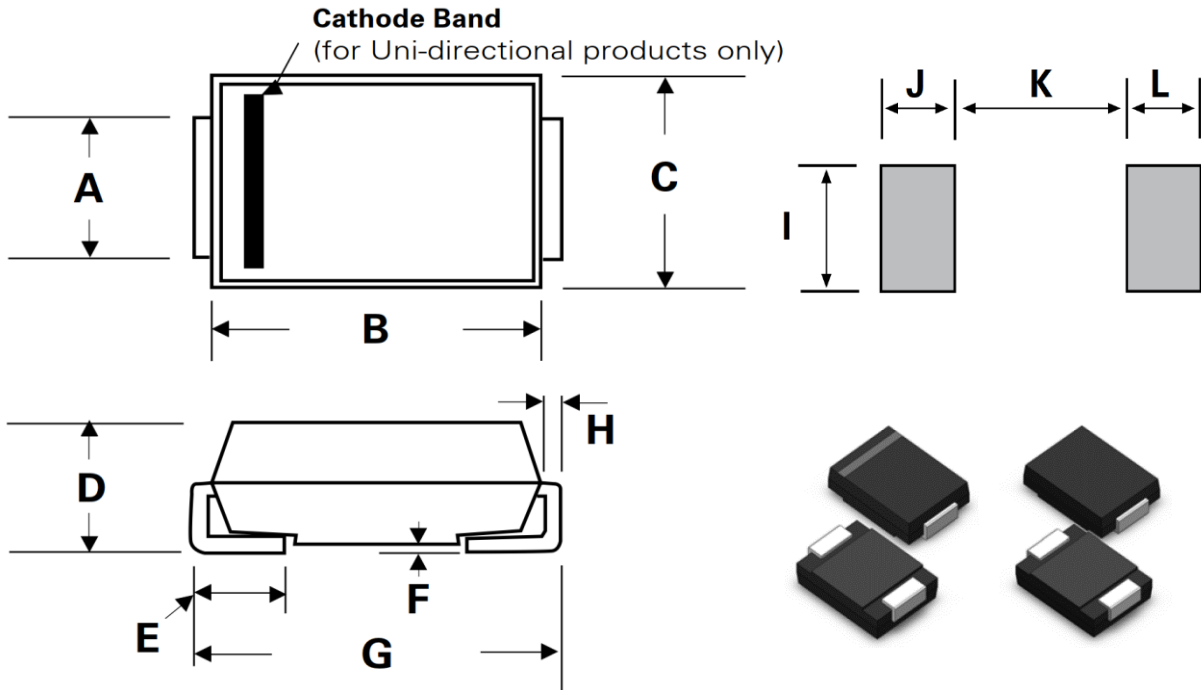

Dimensions	Inches		Millimeters	
	Min	Max	Min	Max
A	0.114	0.126	2.9	3.2
B	0.26	0.28	6.6	7.11
C	0.22	0.245	5.59	6.22
D	0.079	0.103	2.06	2.62
E	0.03	0.06	0.76	1.52
F	-	0.008	-	0.203
G	0.305	0.32	7.75	8.13
H	0.006	0.012	0.152	0.305
I	0.129	-	3.3	-
J	0.094	-	2.4	-
K	-	0.165	-	4.2
L	0.094	-	2.4	-

7. Packaging

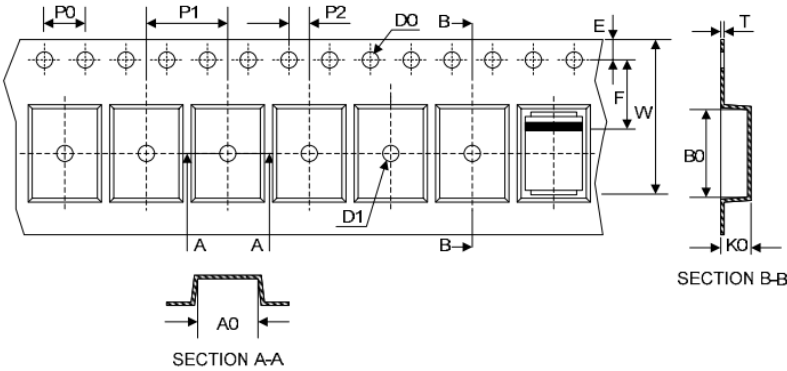
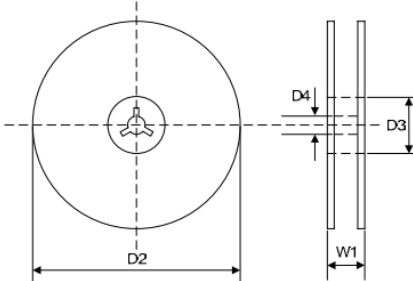
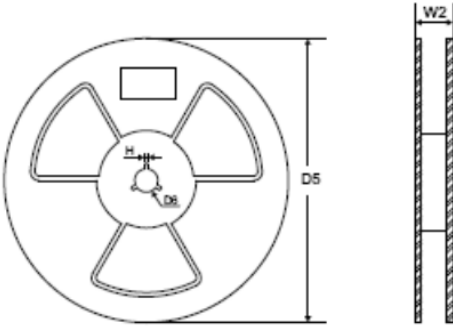
Tape	Symbol	Dimension (mm)
	W	16.00±0.20
	P0	4.00±0.10
	P1	8.00±0.10
	P2	2.00±0.10
	D0	Φ1.5±0.10
	D1	Φ1.5±0.10
	E	1.75±0.10
	F	7.50±0.10
	A0	6.27±0.10
	B0	8.30±0.10
	K0	3.15±0.15
	T	0.30±0.05
	7" Reel	D2
	D3	Φ50.0Min.
	D4	Φ13.0±0.5
	W1	20.0±2.0
	Quantity: 500PCS	
13" Reel	D5	Φ330.0±2.0
	D6	Φ13.5±0.5
	H	2.5±1.0
	W2	20.0±2.0
	Quantity: 3000PCS	

DISCLAIMER

ELECSUPER SUPERTVS PROVIDES TECHNICAL AND RELIABILITY DATA (INCLUDING DATASHEETS), DESIGN RESOURCES (INCLUDING REFERENCE DESIGNS), APPLICATION OR OTHER DESIGN ADVICE, SAFETY INFORMATION, AND OTHER RESOURCES "AS IS" AND WITH ALL FAULTS, AND DISCLAIMS ALL WARRANTIES, EXPRESS AND IMPLIED, INCLUDING WITHOUT LIMITATION ANY IMPLIED WARRANTIES OF MERCHANTABILITY, FITNESS FOR A PARTICULAR PURPOSE OR NON-INFRINGEMENT OF THIRD PARTY INTELLECTUAL PROPERTY RIGHTS.

These resources are intended for skilled developers designing with ElecSuper products. You are solely responsible for

- (1) selecting the appropriate ElecSuper products for your application;
- (2) designing, validating and testing your application;
- (3) ensuring your application meets applicable standards, and any other safety, security, or other requirements.

These resources are subject to change without notice. ElecSuper grants you permission to use these resources only for development of an application that uses the ElecSuper products described in the resource. Other reproduction and display of these resources are prohibited. No license is granted to any other ElecSuper intellectual property right or to any third party intellectual property right. ElecSuper disclaims responsibility for, and you will fully indemnify ElecSuper and its representatives against, any claims, damages, costs, losses, and liabilities arising out of your use of these resources. ElecSuper's products are provided subject to ElecSuper's Terms of Sale or other applicable terms available either on www.elecsuper.com or provided in conjunction with such ElecSuper products. ElecSuper's provision of these resources does not expand or otherwise alter ElecSuper's applicable warranties or warranty disclaimers for ElecSuper products.

X-ON Electronics

Largest Supplier of Electrical and Electronic Components

Click to view similar products for [ESD Suppressors / TVS Diodes](#) category:

Click to view products by [ElecSuper](#) manufacturer:

Other Similar products are found below :

[60KS200C](#) [D18V0L1B2LP-7B](#) [D5V0F4U5P5-7](#) [NTE4902](#) [P4KE27CA](#) [P6KE11CA](#) [P6KE8.2A](#) [SA60CA](#) [SA64CA](#) [SMBJ12CATR](#)
[SMBJ33CATR](#) [SMBJ6.5A](#) [SMBJ8.0A](#) [ESD101-B1-02ELS](#) [E6327](#) [ESD112-B1-02EL](#) [E6327](#) [ESD7451N2T5G](#) [19180-510](#) [CPDT-5V0USP-](#)
[HF](#) [3.0SMCJ33CA-F](#) [3.0SMCJ36A-F](#) [HSPC16701B02TP](#) [JANTX1N6126A](#) [D3V3Q1B2DLP3-7](#) [D55V0M1B2WS-7](#) [SCM1293A-04SO](#)
[ESD200-B1-CSP0201](#) [E6327](#) [SM12-7](#) [CEN955 W/DATA](#) [VESD12A1A-HD1-GS08](#) [CPDQC5V0-HF](#) [D1213A-01LP4-7B](#) [ESD101-B1-02EL](#)
[E6327](#) [AOZ8808DI-03](#) [5KP15A](#) [5KP48A](#) [5KP90A](#) [ESD3V3D7-TP](#) [15KPA36A-LF](#) [P4KE56CA](#) [P4KE68A](#) [P4KE91CATR](#) [P6KE120A](#)
[P6KE13CA](#) [P6KE43CA](#) [P6KE6.8CA](#) [P6KE8.2](#) [P6SMBJ20CA](#) [JANTX1N6072A](#) [SR2835ESKG](#) [SA90CA](#)