

NEVER A DOUBT



ELECTROSWITCH

ELECTROSWITCH Corporation
180 King Avenue
Weymouth, MA 02188
TEL: (781) 335-5200
FAX: (781) 335-4253
www.electroswitch.com

Printed in USA 5M 113

Ⓢ ELECTROSWITCH UTILITY PRODUCTS Ⓢ

Switches and Relays For the Power Industry



 **ELECTROSWITCH**

**The Best Rotary Switches, Relays,
and Electrical Systems Products...**

Backed by the industry's most knowledgeable and responsive engineering and customer service professionals...

Any way you want them...

Delivered when you need them.



**NEVER
A DOUBT**

**THE ELECTRO SWITCH CORPORATION FAMILY...
PROVIDING INTELLIGENT SOLUTIONS FOR SWITCHING AND CONTROL**

ELECTROSWITCH
POWER SWITCHES & RELAYS

Complete line of electrically and manually activated Rotary Switches and Relays for electric utility, defense, and industrial monitoring and control applications



www.electroswitch.com

ELECTROSWITCH
ELECTRONIC PRODUCTS

Rotary Switches; Miniature Toggle, Paddle, Rocker, Power Toggle, and Push-Button Switches; Hall Effect, and Mechanical Encoders; Illuminated Switch Products; and Power Transformers



www.electro-nc.com

DIGITRAN
DIGITAL & ROTARY SWITCHES

Digital and Rotary Switch Products designed for aviation, defense, and industrial switch applications



www.digitran-switches.com

ARGA CONTROLS
MEASUREMENT & CONTROL INSTRUMENTATION

Electric utility, industrial and military-grade Power Meters, Battery Monitors, and Transducers for precision measurement applications



www.argacontrols.com

Sunrise Technologies
OUTDOOR LIGHTING CONTROLS & MONITORING

Wireless Communication Systems for Smart Grid applications and a complete line of Streetlight Monitoring and Control Solutions



www.sun-tech.biz

**ISO 9001
CERTIFIED**

TABLE OF CONTENTS

The Advantage Is Yours	2
Switches and Relays	9
Instrument and Control Switches	10
Lock-out Relays	43
Control Switch Relays	54
Selector Switch Relays	63
Latching Switch Relays	64
Tagging Relays	68
Annunciator Target Relays	71
Trip Coil Monitor	72
Control Indicator Module	73
Construction Details	74
Testing	78
Handles	80
Nameplates	81
Mounting Hardware	82
Jumpers	83

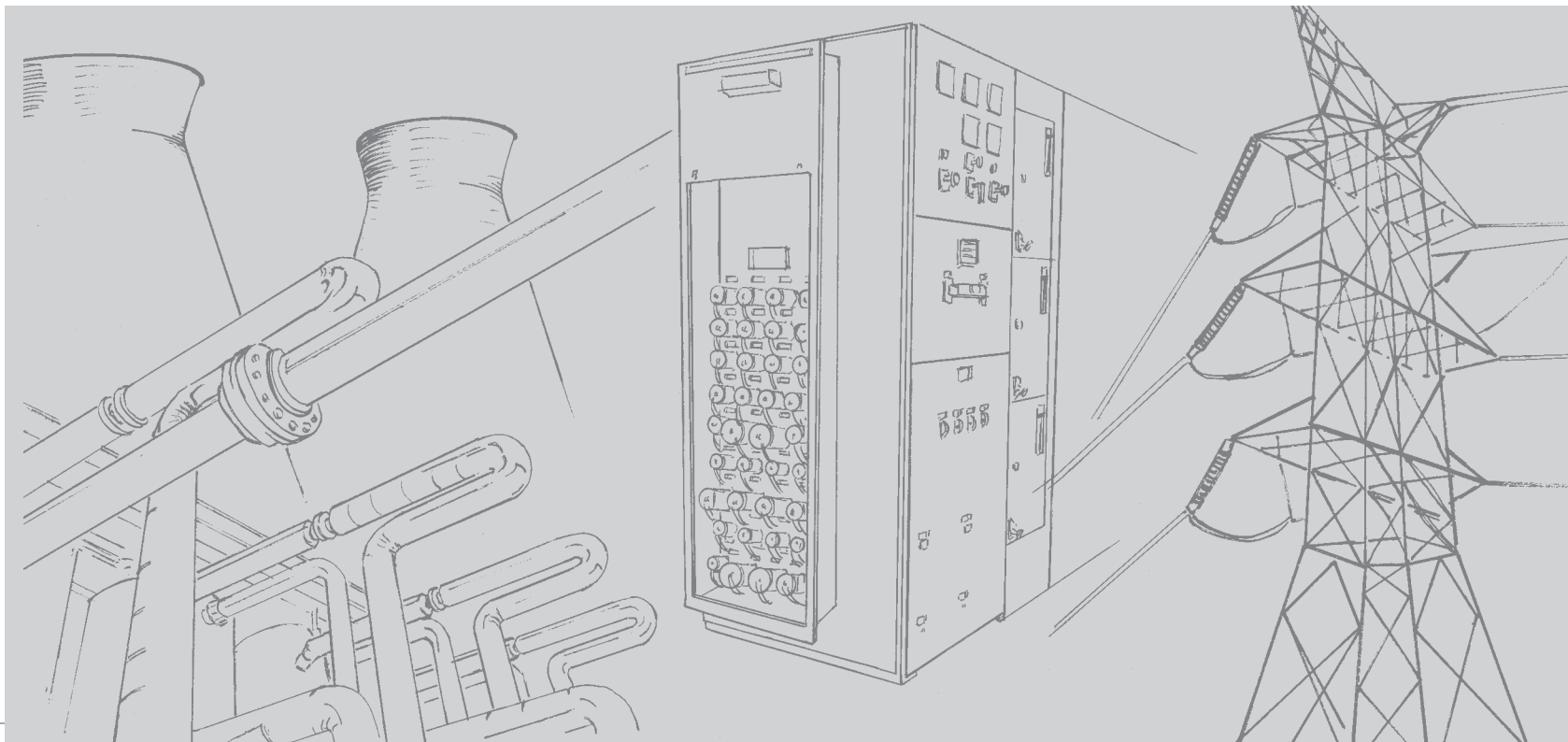

THE ADVANTAGE IS YOURS

When you choose Electroswitch products the advantage is always yours... For over 50 years Electroswitch products have been specified for use in the most demanding, most critical applications in the power industry by virtually every equipment manufacturer and utility in the United States. They know that when you specify Electroswitch products you have chosen the most dependable, most reliable, and most proven products available in the world today. With Electroswitch there is **Never a Doubt.**

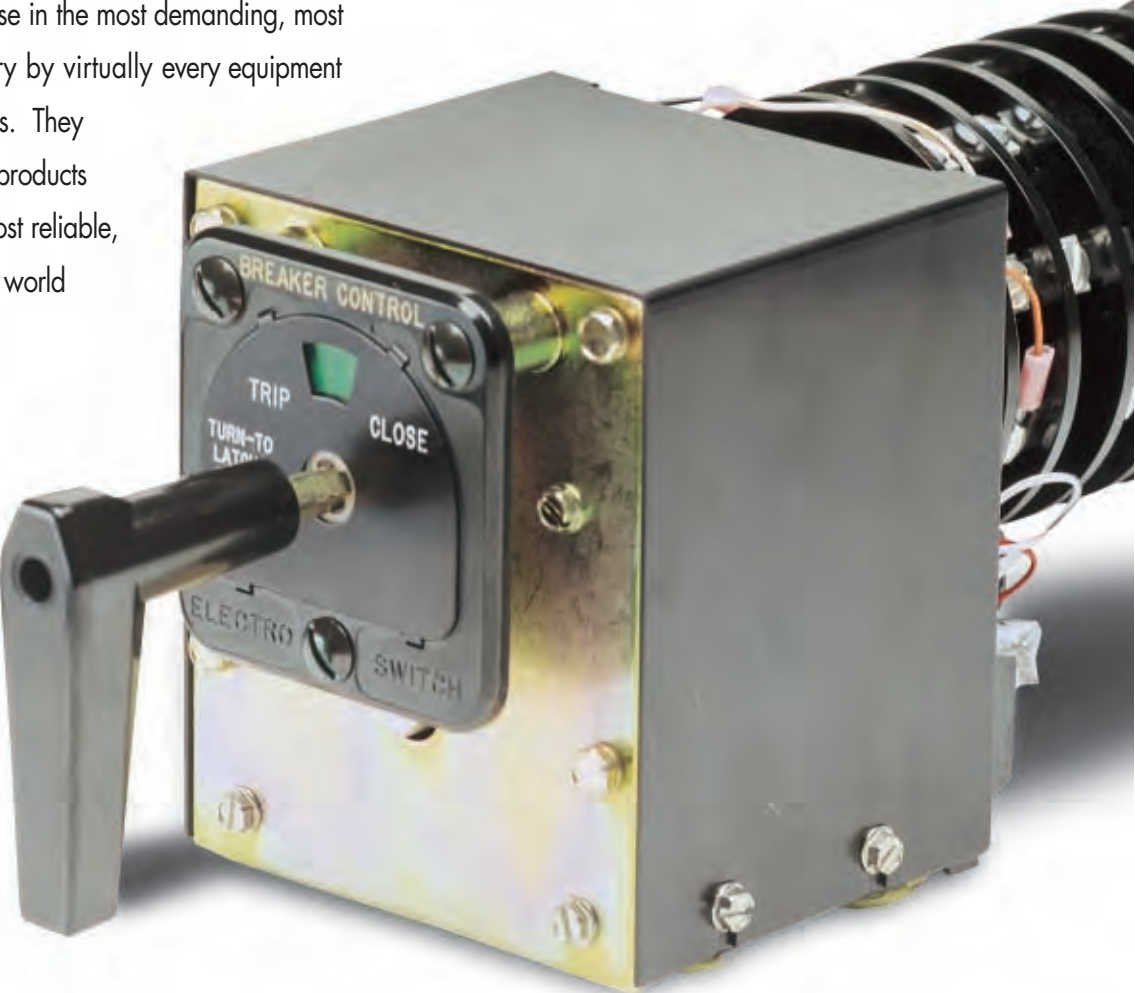

Electroswitch also offers the widest variety of switches and relays available in the power industry today. There are virtually millions of different potential configurations to precisely meet applications.

We offer a choice of manual, remotely operated or SCADA operated products, snap and cam action switches, as well as system products to enhance power industry automation projects.

The Advantage is Always Yours when you work with Electroswitch



THE ADVANTAGE IS YOURS

You Get Everything You Want.

When we say we have a full line of products, we mean exactly that. Our switches and relays are built in three family groups: Detent, Cam Action, and Snap Action. Within the Detent and Cam Action groups we combine manual and remote or SCADA operated designs with standard components in almost limitless configurations to provide literally millions of different models. The objective is not to see how many different switches we can build, but to allow you to choose without compromise or tradeoff the best switch for your particular application.

- *Instrument and Control Switches*
- *Miniature Instrument & Control Switches*
- *Modular Instrument & Control Switches*
- *Tagging Relays*
- *Lock-Out Relays*
- *Control Switch Relays*
- *Selector Switch Relays*
- *Latching Switch Relays*
- *Control Indicator Modules*
- *Serial Communication Control of Electrically Operated Devices*

**A FULL LINE OF
POWER PRODUCTS**



You Get The Highest Quality Product.

Electroswitch is on the Qualified Supplier List of virtually every electric utility in the United States. Our switches are specified for the most demanding duty in hi-shock military shipboard equipment, nuclear power plants and in all types of industrial, construction, and transportation equipment. Anywhere the ability to perform reliably under the most severe conditions of shock and vibration is essential, you will find Electroswitch products. At Electroswitch high quality is not a claim, but a fact proven through over fifty years of field performance.



We'll Meet Your Scheduling and Delivery Requirements.

We take great pride in meeting customer delivery requirements – no matter how stringent. In addition to orders by mail, phone, and fax, we also take orders electronically utilizing EDI. Use your MRP system to place orders direct. If your requirements change after placing your order, just give us a call; we can usually adjust our schedule to meet your new requirements.



THE ADVANTAGE IS YOURS

You Can Get Modifications Tailored To Your Needs.

Just because we have millions of configurations to choose from doesn't mean we won't design and build something special for you. Tell us what you need, or explain your application to us. Our application engineers will solve your problem precisely by modifying one of our standard models or creating something entirely new. You don't have to settle for almost right; we'll get it exactly right for you.

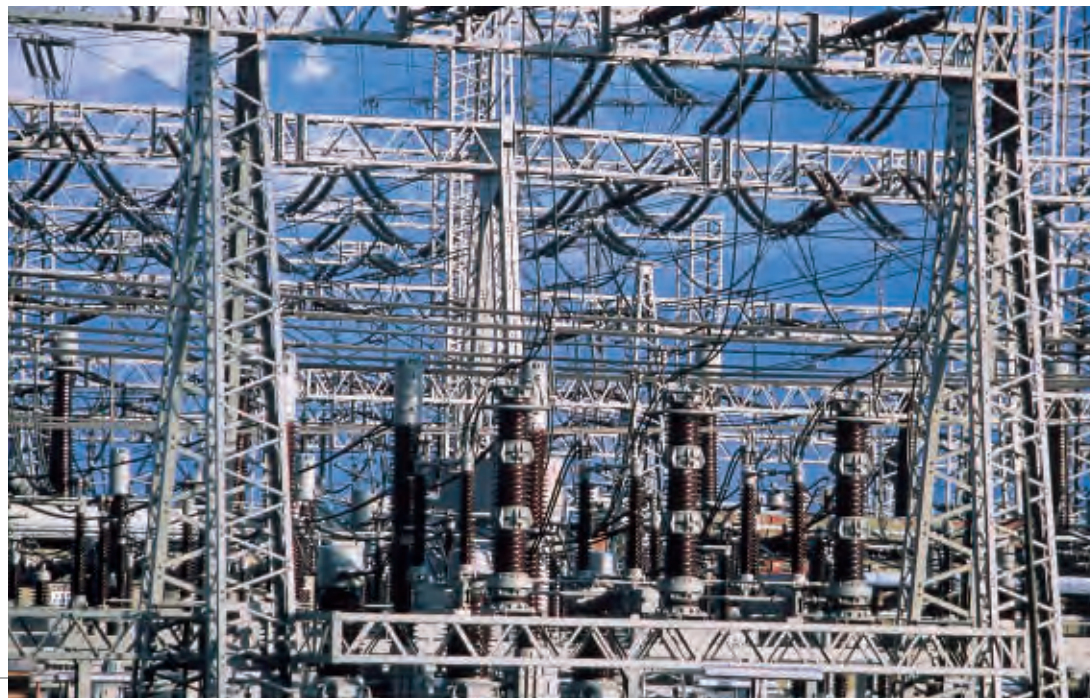

You Get Total Support.



We recognize our responsibility to you, our customers, and know that it goes far beyond simply delivering switches, relays, and electrical systems.

Application Assistance

More than simple assistance. We have a fully trained staff of applications professionals who are anxious to help you solve virtually any switching and relaying problems you may have.

Engineering

We have the industry's most knowledgeable, dedicated, and willing engineering staff waiting to go to work for you. If you need a special switch or relay, give us a call; we'll solve your switching problems.

Special Training

We won't leave you on your own. If you need any special training or other assistance, we're more than happy to provide this service.



THE ADVANTAGE IS YOURS

Electroswitch...

- ✓ Products proven in the most demanding power industry applications
- ✓ Products with the highest dependability and reliability
- ✓ Proven performance in high shock and vibration environments
- ✓ Qualified supplier to virtually every electric utility in the United States
- ✓ Widest variety of switches and relays available in the industry
- ✓ Custom tailored product modifications to meet specialized applications
- ✓ Strongest technical support team in the industry
- ✓ Ability to meet the most stringent delivery requirements
- ✓ Place orders electronically using EDI, or utilize mail, phone, or fax



SWITCHES AND RELAYS FOR THE ELECTRIC POWER INDUSTRY



STANDARD INSTRUMENT AND CONTROL SWITCHES Page 10

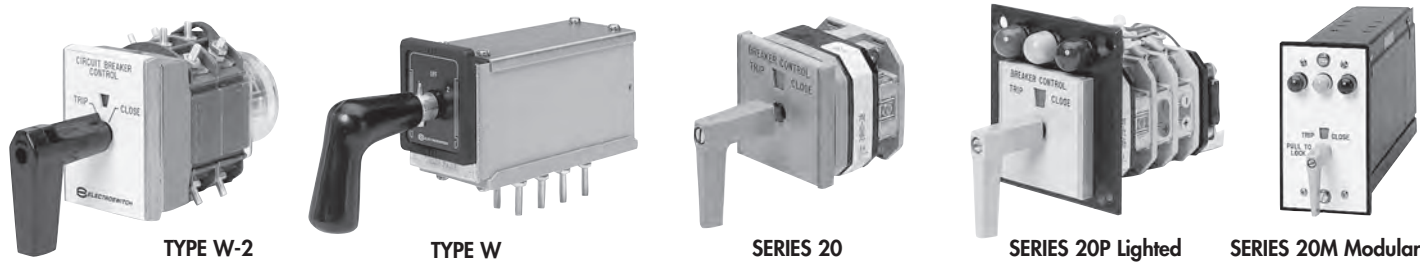

LOCK-OUT RELAYS Page 43

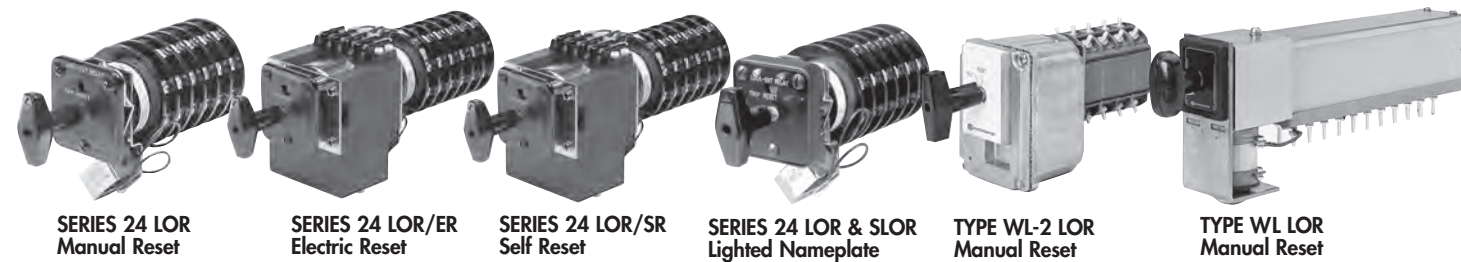

CSR	Page 54
TD-CSR	Page 61
SSR	Page 63
LSR	Page 64
TR	Page 68
ATR	Page 71
TCM	Page 72
CIM	Page 73





INTRODUCTION

INSTRUMENT AND CONTROL SWITCHES

Choose the switch that best suits your application

Electroswitch offers a wide variety of Rotary Instrument and Control Switches designed specifically to satisfy the most stringent requirements of Substation Automation, Power Generation, Transmission, and Distribution systems. In fact, we offer the world's most complete, tested, and proven line of rotary switches available today.

The following is a quick description of each series. It is designed to help you select the one that is right for you.

INTERRUPTING CURRENT RATINGS				
	120VAC	240VAC	600VAC	125VDC
Series 24	20A	15A	6A	3A
Series 31	10A	5A	3A	1A
Series 20	20A	20A	20A	3A
Series 101	15A	10A	8A	10A
Type W	50A	25A	5A	8A
Type W2	30A	20A	8A	5A



Series 24

The quality standard in the utility industry, the Series 24 features low resistance, double-wiping contacts with self-cleaning silver contacts for years of reliable service. They are available with up to ten decks (20 poles) and allow for between 2 and 8 positions. These switches are rated at 30 amps @ 600 volts.

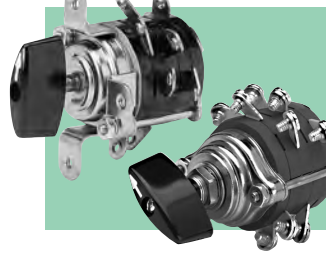

Series 101 Single or Four Hole Mount

Series 101 Switches are a snap-action design that are available for either AC or DC applications. These switches feature low resistance double-wiping contacts. Rated at 20 amps @ 600 volts.



Series 24P With Lighted Nameplate

All the same great features you've come to expect in our Series 24 Switches now available with built-in, cost-effective, long-life LED indicators. The industry standard – a better value than ever.



Series 102 Auxiliary

The Series 102 Auxiliary Switch is based on the contact mechanism of the 101 Snap-Action Switch modified to allow lever arm activation. Rated at 20 amps @ 600 volts.



Series 31

The Series 31 features our low resistance, double-wiping contacts in a smaller package. They are available with up to ten decks (20 poles) and allow for between 2 and 8 positions, and can be ordered for either single or 4 hole mounting. Series 31 Switches are rated at 15 amps @ 600 volts.

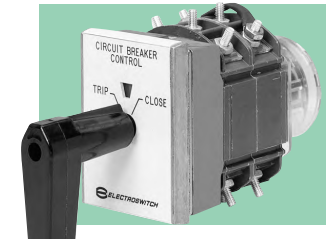

Type W2

The Type W2 uses a contact roller, spring-actuated design that provides for momentary, maintained, or lateral contacting. These switches can be provided with up to eight decks (48 poles) and between 2 and 12 positions. Type W2 Switches are rated at 20 amps @ 600 volts.

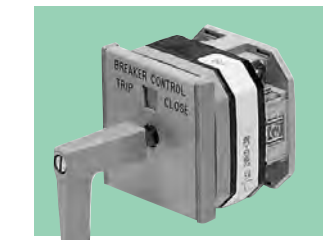

Series 20

The Series 20 Cam Switches have a very small footprint and are designed specifically to reduce the space required on a control panel. They can be mounted on 3" centers and are available in a standard configuration, modular plug-in design, or with a lighted front panel. These switches are available with up to 12 decks (24 poles) and between 2 and 12 positions. Series 20 Switches are rated at 24 amps @ 600 volts.

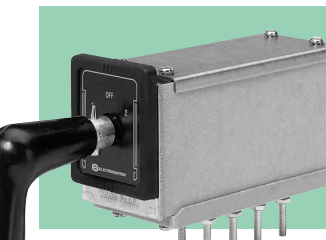

Type W

Type W Switches are reliable, proven products still used in many time-tested applications. These switches are available with up to 10 poles and between 2 and 12 positions. Type W Switches are rated at 20 amps @ 600 volts.



SERIES 24 INSTRUMENT AND CONTROL SWITCHES

Features

- Double-Sided, Double-Wiping, Knife-Type Rotary Contacts
- Silver Contact Surfaces for Long, Reliable Low Contact Resistance Life
- #8-32 Terminal Screws — Easy Installation of #12AWG Wire
- Standard Three Hole Panel Mount

Control Switch Special Features

- Spring Return to Normal (Vertical) Position Multi-Pole Contact Arrangements
- Mechanical Red/Green Target
- Slip Contacts for "Normal After" Applications
- Pull to Lock for Safety Lockout (see page 74)

Instrument Switch Special Features

- Make-Before-Break (Shorting) Contacts
- Common Input Tap Switch Arrangement — Sequentially Connected to Several Lines Using the Same Switching Deck
- Positive Positioning Detent Mechanism
- Pre-Wired Applications

Synchroscope Special Features

- Removable Oval Handles
- Keyed Arrangements

Electrical Specifications

Continuous Ratings 30A/600V

Interrupt Ratings 20A/120VAC • 15A/240VAC • 6A/600VAC • 3A/125VDC • 1A/250VDC

- Overload Current (50 operations) 95A/120VAC • 65A/240VAC • 35A/600VAC
- Making Ability for Circuit Breaker Coils 95A—125VDC
- Contacts Resistance .01ohms maximum

Mechanical Specifications

Sections	1 to 10 — Consult Factory For Additional Sections
Poles	1 to 20 — Consult Factory For Additional Poles
Positions	8; Adjustable Stops for 2—8 Position Rotation
Contacts	Break-Before-Make (Non-Shorting); Make-Before-Break (Shorting)
Action	45° Positive Detent or Momentary Indexing
Mounting	Panel Mount, 3 Hole Mounting, Hardware Supplied
Panel Thickness	3/16" Max. Standard — Others Available
Rotor Contacts	Silver Overlay Phosphor-bronze, Double-Wiping
Stationary Contacts	Silver Inlay, with Integral Screw Type Terminals
Construction	Contacts Enclosed in Molded-phenolic Insulators

Approvals

- UL: File No. E18174
- CSA
- Class 1E Nuclear
- CE

Note: The Series 24 Class 1E Utility products comply with the following Nuclear Standards: ANSI/IEEE C37.90, ANSI/IEEE C37.90.01, ANSI/IEEE C37.98, ANSI/IEEE C37.105, ANSI/IEEE 323, ANSI/IEEE 344, ANSI/ASME NQA-1.



ORDERING INFORMATION -

(For generic switches fill out matrix below. For application specific switches see page 15.)
If you don't see the switch you need, please consult the factory.

Assemblage 2

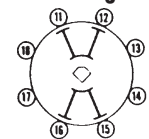

Assemblage 3

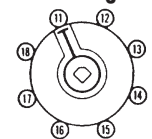

Note 1: Nominal torques, weights, and depth behind panel are listed below.

Note 2: Assemblages are shown with handle in 0° position (12 o'clock).

Model No. **24** [] [] [] - [] []

Series	[] [] [] [] [] [] [] [] [] []
Assemblage	2 = Assemblage 2 3 = Assemblage 3
Handle Type	B = Oval Shank C = Round Knurled D = Pistol Grip E = Removable Oval
Shorting	Blank = No S = Yes

Matrix Code	No. of Sections	Weight (lbs.)	Torque (lb./in)	Depth Behind Panel
01 =	1	1.1	8	2.41
02 =	2	1.2	9	2.78
03 =	3	1.3	10	3.53
04 =	4	1.4	11	4.28
05 =	5	1.5	12	4.66
06 =	6	1.6	13	5.41
07 =	7	1.7	14	6.16
08 =	8	1.8	15	6.53
09 =	9	1.9	16	7.41
10 =	10	2.0	17	8.03

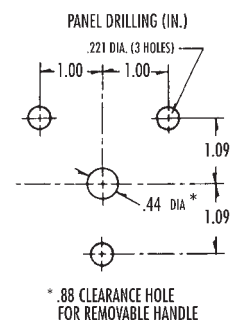
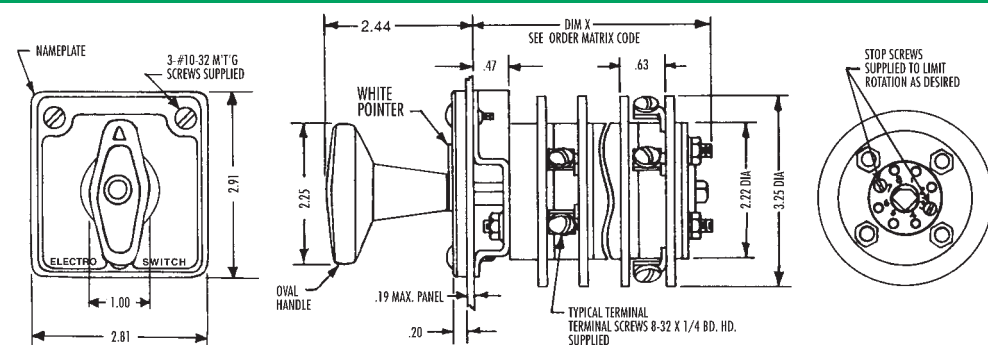



NEW PRODUCT **SERIES 24**
"Smart" Lighted Nameplate

Series 24 Lighted Nameplates

The Series 24 family of Manual and Remotely Operated Switches are Now Available with Built-In, Cost-Effective, Long-Life LED Indicators. The Series 24 Switch, the Utility Industry Standard for Quality and Reliability is Now a Better Value Than Ever!

Benefits

- Saves Panel Space
- Reduces Purchase and Installation Cost
- Easy to Use... No Special Operator Training
- Provides Local and Remote (SCADA) Annunciation of Breaker Trip Coil Failure

Features

- Can be used on ALL Series 24 Switches
- Is Available with One, Two or Three Replaceable LEDs
- Flexible Circuitry lets LEDs be Wired to Indicate Any Desired Event
- Is Available With or Without a Mechanical Target
- 125VDC Unit Covers IEEE 48V/125V Ranges (38 to 140VDC)
- AC Unit Available
- Saves Panel Space by Fitting up to 3 LEDs into the Standard Series 24 Nameplate Footprint
- Allows Monitoring of Breaker Trip Coil with Local (Center LED) and SCADA Annunciation
- Model Available to Simultaneously Monitor Two Independent Isolated Trip Coils
- Uses Large LEDs that:
 - Are Brighter than the Typical Incandescent Bulb
 - Have an 11 Year Life (Typical)
 - Are Socket Mounted for Design Flexibility and Easy Front of Panel Field Replacement
 - Are More Rugged than Incandescent Bulbs
 - Are Available in Red, Green, Amber, Blue and White
 - Each LED Draws Less than 10mA when Lit

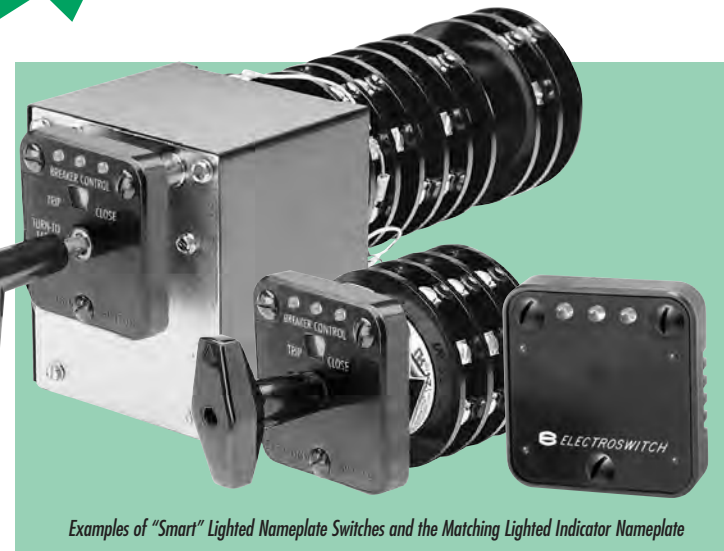

Examples of "Smart" Lighted Nameplate Switches and the Matching Lighted Indicator Nameplate

Approvals

- UL File No. E18174
- CE

Ordering Information

Part Numbers for the Series 24 Switches with Lighted Target Nameplate are fairly simple. Find the part number of the product you wish to order in the Electroswitch catalog, then simply add a two letter code after the second digit in its part number. The first letter of the code will always be "P" indicating a Lighted Target Nameplate. The second letter will change depending on the options as follows.

- A = Single LED, Amber, 48/125VDC
- B = Two LEDs, Green/Red, 48/125VDC
- C = Three LEDs, Green/Amber/Red, 48/125VDC
- D = Three LEDs, Green/Red/Red, 48/125VDC (Dual Trip Coil Monitor)
- E = Single LED, Amber, 120VAC
- F = Two LEDs, Green/Red, 120VAC
- G = Three LEDs, Green/Amber/Red, 120VAC

Consult factory for 24VDC, 250VDC, and special configurations.

Example One:

A Series 24 Breaker Control Switch with circuit number 38 and a pistol grip handle is part number **2438D**. The same Breaker Control Switch with a Lighted Target Nameplate, three LEDs, and 120VAC LED voltage would become part number **24PG38D**.

Example Two:

A Series 24 Control Switch Relay with standard circuit number 57, 48VDC relay operating voltage, and control circuit "C" is part number **8857CC**. The same Control Switch Relay with a Lighted Target Nameplate, Three LEDs, and 48/125VDC LED voltage would become part number **88PC57CC**.

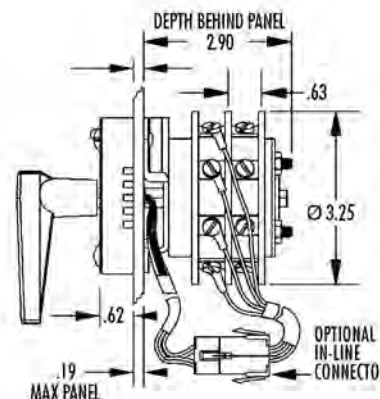
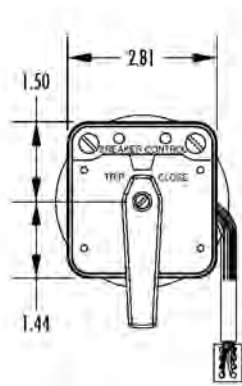
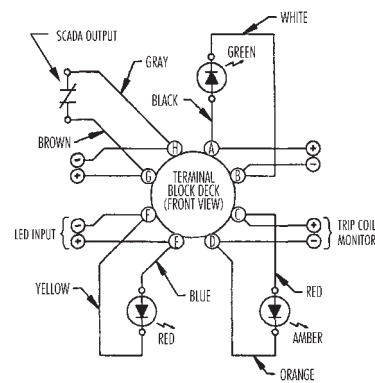

Depth Behind Panel

Decks	Depth
1	3.06
2	3.43
3	4.18
4	4.93
5	5.31
6	6.06
7	6.81
8	7.18
9	8.06
10	8.68

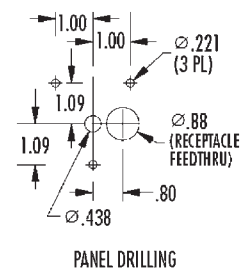



SERIES 31

INSTRUMENT AND CONTROL SWITCHES

Features

- Double-Sided, Double-Wiping, Knife-Type Rotary Contacts
- Silver Contact Surfaces for Long, Reliable Life
- Terminal Screws — Easy Installation
- Standard Four Hole Mount
Single Hole Mount Available - Consult Factory

Control Switch Special Features

- Spring Return to Normal (Vertical) Position

Instrument Switch Special Features

- Make-Before-Break (Shorting Contacts)
- Common Input Tap Switch Arrangement — Sequentially Connected to Several Lines Using the Same Switching Deck
- Positive Positioning Detent Mechanism
- Pre-Wired Jumpers

Electrical Specifications

Continuous Ratings

- 15A/600V

Interrupt Ratings

- 10A/120VAC
- 5A/240VAC
- 3A/600VAC
- 5A/30VDC
- 1A/125VDC
- Overload Current (50 operations): 60A/125VAC Resistive
- Voltage Breakdown: 2200V rms minimum
- Insulation Resistance: 100 Megohms minimum
- Contacts Resistance: .01ohms maximum
- Making Ability for Circuit Breaker Coils: 45A–125VDC

Mechanical Specifications

Sections	1 to 10
Poles	1 to 20
Positions	8; Adjustable Stops for 2–8 Position Rotation
Contacts	Break-Before-Make (Non-Shorting); Make-Before-Break (Shorting)
Action	45° Positive Detent Indexing
Mounting	4 Hole
Panel Thickness	3/16" Max. Standard
Rotor Contacts	Silver Plated Phosphor-bronze, Double Grip
Stationary Contacts	Silver Plated Copper, w/Integral Screw Type Terminals
Construction	Contacts Enclosed in Molded-phenolic Disks

Approvals

- UL File No. E18174
- CSA
- CE

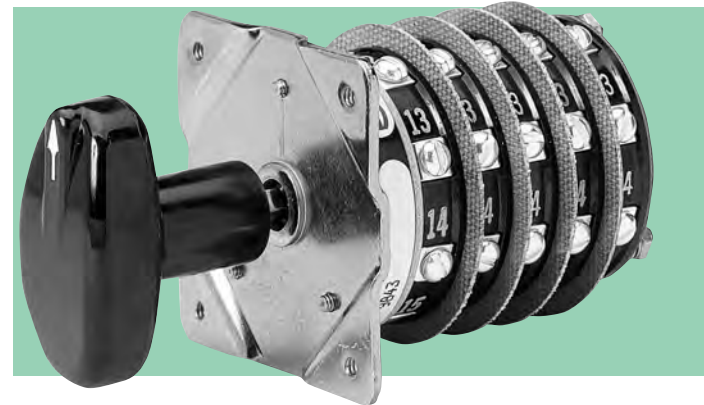

ORDERING INFORMATION -

(For generic switches fill out matrix below. For application specific switches see page 15.)

Four Hole Mount Assemblages

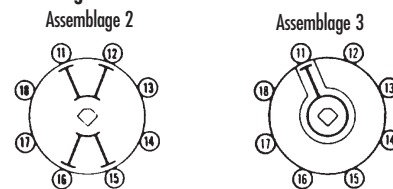

- Note 1:** Nominal torques, weights, and depth behind panel are listed below.
Note 2: Assemblages are shown with handle in 0° position (12 o'clock).

Model No. **31**

Series _____

Assemblage **2** = Assemblage 2
3 = Assemblage 3

Mounting Style/Handle
B = Four Hole/Oval Shank
C = Four Hole/Round Knurled
D = Four Hole/Pistol Grip

Shorting
Blank = No
S = Yes

Matrix Code	No. of Sections	Weight (oz)	Torque (lbs/in)	Depth Behind Panel	
				4 Hole	
01 =	1	5	6	1.25	
02 =	2	6	7	1.63	
03 =	3	7	8	2.00	
04 =	4	8	9	2.38	
05 =	5	9	10	2.75	
06 =	6	10	11	3.13	
07 =	7	11	14	3.75	
08 =	8	13	15	4.13	
09 =	9	14	16	4.50	
10 =	10	15	17	4.88	

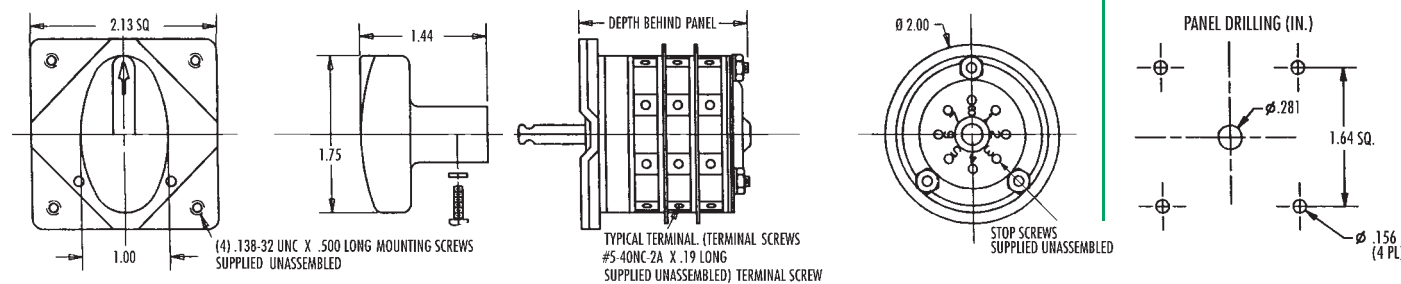



DESIGN A SWITCH TO MEET YOUR NEEDS

SERIES 24 AND SERIES 31 ROTARY SWITCHES

Description Indexing Contact Diagram * Wiring Diagram Ordering Information

Detent Action Rotary Switches

SINGLE-THROW
OFF - ON
Stop screw positions: 1 & 7
Handle: Oval



DECK	CONTACTS	POS.
1	1 2 ○ — — ○ 1 3	OFF
	1 6 ○ — — ○ 1 7	ON

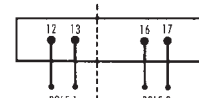

Series
24 = Series 24
31 = Series 31

No. Of Decks
01 = 1 06 = 6
02 = 2 07 = 7
03 = 3 08 = 8
04 = 4 09 = 9
05 = 5 10 = 10

Shorting
Blank = No
S = Yes

Assemblage
2 = 2

Model numbers are for universal switches that provide all contacting shown. To limit switches to positions shown put limit screws in rear stop plate.

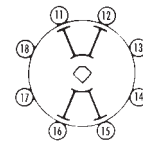

DOUBLE-THROW
No Off
Stop screw positions: 1 & 7
Handle: Oval



DECK	CONTACTS	POS.
1	1 2 ○ — — ○ 1 1	1
	1 6 ○ — — ○ 1 5	2

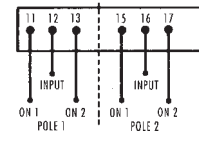

DOUBLE-THROW
With Off
Stop screw positions: 2 & 7
Handle: Oval

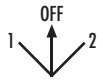

DECK	CONTACTS	POS.
1	1 1 ○ — — ○ 1 8	OFF
	1 2 ○ — — ○ 1 3	1
	1 5 ○ — — ○ 1 4	2
	1 6 ○ — — ○ 1 7	3

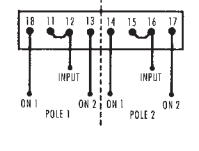

Jumpers** for these arrangements are sold separately (2 per deck Series 24 P/N 02011-10-C3
2 per deck Series 31 P/N 03057-1-C3).

* Contacts are shown for the first deck. All decks are identical.
Contact number changes in additional decks (e.g. 11 is deck 1, 21 is deck 2, etc.).

** 11-12, 15-16 connected internally in normal position.

Momentary (Spring-Return) Action Rotary Switches

SINGLE-THROW
OFF - ON
Stop screw positions: 1 & 7
Handle: Pistol Grip



DECK	CONTACTS	POS.
1	1 2 ○ — — ○ 1 3	OFF
	1 6 ○ — — ○ 1 7	ON

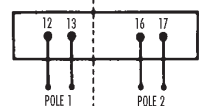

Series
74 = Series 24
75 = Series 31

No. Of Decks
01 = 1
02 = 2
03 = 3
04 = 4
05 = 5

Shorting
Blank = No
S = Yes

Assemblage
2 = 2

Model numbers are for universal switches that provide all contacting shown. To limit switches to positions shown put limit screws in rear stop plate.

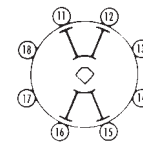

DOUBLE-THROW
No Off
Stop screw positions: 1 & 7
Handle: Pistol Grip



DECK	CONTACTS	POS.
1	1 2 ○ — — ○ 1 1	1
	1 6 ○ — — ○ 1 5	2

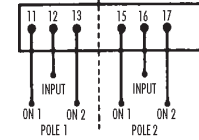

DOUBLE-THROW
With Off
Stop screw positions: 2 & 7
Handle: Pistol Grip



DECK	CONTACTS	POS.
1	1 1 ○ — — ○ 1 8	OFF
	1 2 ○ — — ○ 1 3	1
	1 5 ○ — — ○ 1 4	2
	1 6 ○ — — ○ 1 7	3

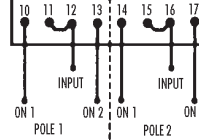

Jumpers** for these arrangements are sold separately (2 per deck Series 24 P/N 02011-10-C3
2 per deck Series 31 P/N 03057-1-C3).

* Contacts are shown for the first deck. All decks are identical.
Contact number changes in additional decks (e.g. 11 is deck 1, 21 is deck 2, etc.).

** 11-12, 15-16 connected internally in normal position.

Rotary Tap Switches (2-7 Throw Switches With Off, Oval Handle)

TWO-THROW
Stop screw positions: 1 & 7

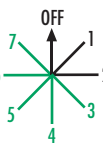

DECK	CONTACTS	POSITIONS							
		OFF	1	2	3	4	5	6	7
1	1 1 ○ — — ○ 1 2		X						
	1 2 ○ — — ○ 1 3			X					
	1 3 ○ — — ○ 1 4				X				
	1 4 ○ — — ○ 1 5					X			
	1 5 ○ — — ○ 1 6						X		
	1 6 ○ — — ○ 1 7							X	
	1 7 ○ — — ○ 1 8								X

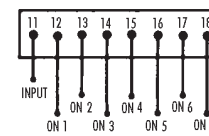

Series
24 = Series 24
31 = Series 31

No. Of Decks
01 = 1 06 = 6
02 = 2 07 = 7
03 = 3 08 = 8
04 = 4 09 = 9
05 = 5 10 = 10

Shorting
Blank = No
S = Yes

Assemblage
3 = 3

Model numbers are for universal switches that provide all contacting shown. To limit switches to positions shown put limit screws in rear stop plate.

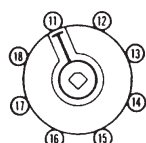

TRIPLE-THROW
Stop screw positions: 1 & 5

FOUR-THROW
Stop screw positions: 1 & 4

FIVE-THROW
Stop screw positions: 1 & 3

SIX-THROW
Stop screw positions: 1 & 2

SEVEN-THROW
Stop screw positions: none

Indexing For
2-7 Throw
Tap Switches

* Contacts are shown for the first deck. All decks are identical. Contact number changes in additional decks (e.g. 11 is deck 1, 21 is deck 2, etc.).



APPLICATION SPECIFIC SWITCHES

SERIES 24 AND SERIES 31 ROTARY SWITCHES

VOLTMETER-Transfer Switches

2-wire, single-phase or D.C.
 Depth Behind Panel: 2.4"
 Handle: Round, Knurled
 Engraving and jumpering as shown

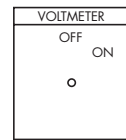

DECK	CONTACTS	POS.
1	1 2 0-1-13 5 0-1-17	1 2

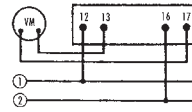

Order #
 Series 24 = 2401C includes NP 10D-2V14
 Series 31 = 3101C includes NP 31D-2V14

4-wire, two-phase or two separate D.C. circuits
 Depth Behind Panel: 2.4"
 Handle: Round, Knurled
 Engraving and jumpering as shown

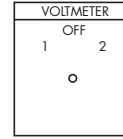

DECK	CONTACTS	POS.
1	1 1 0-1-13 2 0-1-17	1 2
2	1 5 0-1-13 6 0-1-17	1 2

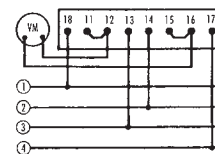

Order #
 Series 24 = 2402C includes NP 10C-3V14
 Series 31 = 3102C includes NP 31C-3V14

3-phase, phase-to-neutral
 Depth Behind Panel: 2.9"
 Handle: Round, Knurled
 Engraving and jumpering as shown

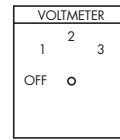

DECK	CONTACTS	POSITIONS
1	1 1 0-1-12 2 0-1-13 3 0-1-14	1 2 3
2	2 1 0-1-22 3 0-1-23 4 0-1-24	1 2 3

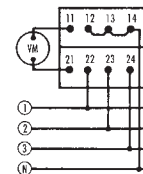

Order #
 Series 24 = 2403C includes NP 10C-4V15A
 Series 31 = 3103C includes NP 31C-4V15A

VOLTMETER-Transfer Switches

3-phase, phase-to-phase
 Depth Behind Panel: 2.9"
 Handle: Round, Knurled
 Engraving and jumpering as shown

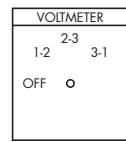

DECK	CONTACTS	POSITIONS
1	1 1 0-1-12 2 0-1-13 3 0-1-14	1 2 3
2	2 1 0-1-22 3 0-1-23 4 0-1-24	1 2 3

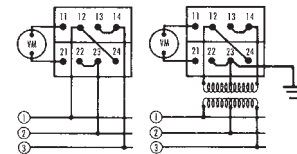

Order #
 Series 24 = 2404C includes NP 10C-4V21
 Series 31 = 3104C includes NP 31C-4V21

3-phase, phase-to-phase and phase-to-neutral
 Depth Behind Panel: 2.9"
 Handle: Round, Knurled
 Engraving and jumpering as shown

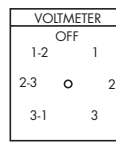

DECK	CONTACTS	POSITIONS
1	1 1 0-1-12 2 0-1-13 3 0-1-14 4 0-1-17 5 0-1-18	1 2 3
2	2 1 0-1-22 3 0-1-23 4 0-1-24 5 0-1-27 6 0-1-28	1 2 3

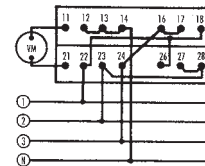

Order #
 Series 24 = 2405C includes NP 10E-7V24
 Series 31 = 3105C includes NP 31E-7V24

6-wire, two 3-phase circuits; phase-to-phase
 Depth Behind Panel: 2.9"
 Handle: Round, Knurled
 Engraving and jumpering as shown

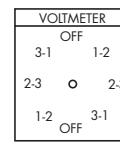

DECK	CONTACTS	POSITIONS
1	1 1 0-1-12 2 0-1-13 3 0-1-14 4 0-1-17 5 0-1-18	1 2 3
2	2 1 0-1-22 3 0-1-23 4 0-1-24 5 0-1-27 6 0-1-28	1 2 3

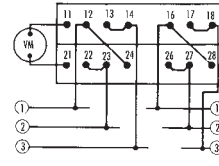

Order #
 Series 24 = 2406C includes NP 10E-8V33
 Series 31 = 3106C includes NP 31E-8V33

AMMETER-Transfer Switches

3-phase, two current-transformers
 Depth Behind Panel: 2.9"
 Handle: Round, Knurled
 Engraving and jumpering as shown

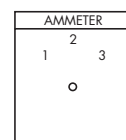

DECK	CONTACTS	POSITIONS
1	1 1 0-1-13 2 0-1-14	1 2 3
2	2 1 0-1-23 3 0-1-24	1 2 3

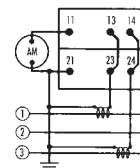

* Denotes make-before-break

Order #
 Series 24 = 2407C includes NP 10C-3A10A
 Series 31 = 3107C includes NP 31C-3A10A

3-phase, two current-transformers
 Depth Behind Panel: 2.9"
 Handle: Round, Knurled
 Engraving and jumpering as shown

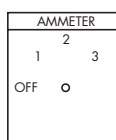

DECK	CONTACTS	POSITIONS
1	1 1 0-1-13 2 0-1-14	1 2 3
2	2 1 0-1-23 3 0-1-24	1 2 3

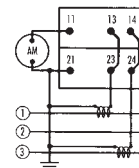

* Denotes make-before-break

Order #
 Series 24 = 2408C includes NP 10C-4A13
 Series 31 = 3108C includes NP 31C-4A13

3-phase, three current-transformers
 Depth Behind Panel: 2.9"
 Handle: Round, Knurled
 Engraving and jumpering as shown

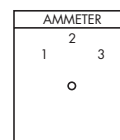

DECK	CONTACTS	POSITIONS
1	1 1 0-1-12 2 0-1-13 3 0-1-14	1 2 3
2	2 1 0-1-22 3 0-1-23 4 0-1-24	1 2 3

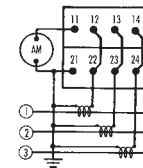

* Denotes make-before-break

Order #
 Series 24 = 2409C includes NP 10C-3A10A
 Series 31 = 3109C includes NP 31C-3A10A



APPLICATION SPECIFIC SWITCHES

SERIES 24 AND SERIES 31 ROTARY SWITCHES

AMMETER-Transfer Switches

3-phase, three current-transformers
 Depth Behind Panel: 2.9"
 Handle: Round, Knurled
 Engraving and jumpering as shown

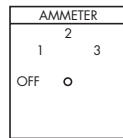

DECKS	CONTACTS	POSITIONS
		1 * 2 * 3
1	11-12 11-13 11-14	X X X
2	21-22 21-23 21-24	X X X

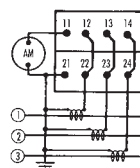

* Denotes make-before-break

Order #
 Series 24 = 2410C includes NP 10C-4A13
 Series 31 = 3110C includes NP 31C-4A13

3-phase, three current-transformers three independent circuits
 Depth Behind Panel: 5.4"
 Handle: Round, Knurled
 Engraving and jumpering as shown

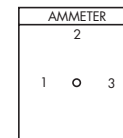

For 2411C or 3111C

DECK	CONTACTS	POSITIONS
		1 * 2 * 3
1	11-12 11-13 11-14 11-15 11-16 11-17	X X X X X X
2	21-22 21-23 21-24 21-25 21-26 21-27	X X X X X X
3	31-32 31-33 31-34 31-35 31-36 31-37	X X X X X X
4	41-42 41-43 41-44 41-45 41-46 41-47	X X X X X X
5	51-52 51-53 51-54 51-55 51-56 51-57	X X X X X X
6	61-62 61-63 61-64 61-65 61-66 61-67	X X X X X X

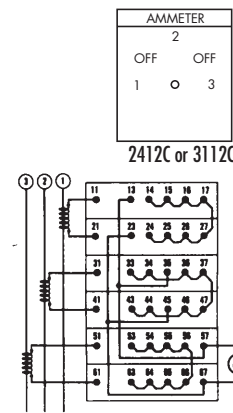

2412C or 3112C

* Denotes make-before-break

Order #
 Series 24 = 2411C includes NP 10A-3A10
 Series 31 = 3111C includes NP 31A-3A10
 Series 24 = 2412C includes NP 10C-5A16
 Series 31 = 3112C includes NP 31C-5A16

AMMETER-VOLTMETER-Transfer Switch

3-phase, phase-to-phase three current-transformers
 Depth Behind Panel: 4.3"
 Handle: Round, Knurled
 Engraving and jumpering as shown

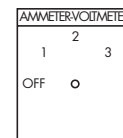

DECKS	CONTACTS	POSITIONS
		1 * 2 * 3
1	11-12 11-13 11-14	X X X
2	21-22 21-23 21-24	X X X
3	31-32 31-33 31-34	X X X
4	41-42 41-43 41-44	X X X

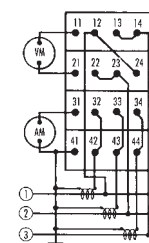

* Denotes make-before-break

Order #
 Series 24 = 2415C includes NP 10C-4A23C
 Series 31 = 3115C includes NP 31C-4A23C

WATTMETER-Transfer Switches

3-phase, three current-transformers, three current-coils
 Depth Behind Panel: 3.6"
 Handle: Round, Knurled
 Engraving and jumpering as shown

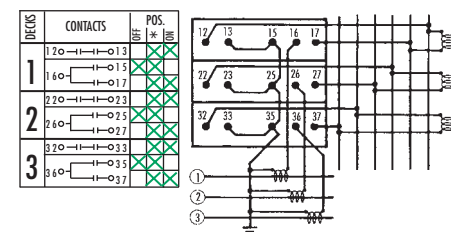
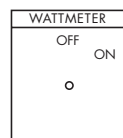

Order #
 Series 24 = 2419C includes NP 10D-2W14
 Series 31 = 3119C includes NP 31D-2W14

3-phase, two current-transformers, two current-coils, two potential coils
 Depth Behind Panel: 3.6"
 Handle: Round, Knurled
 Engraving and jumpering as shown

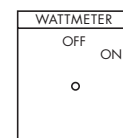

DECKS	CONTACTS	POS.
		OFF * ON
1	12-13 16-15 16-17	X X X
2	22-23 26-25 26-27	X X X
3	32-33 36-35 36-37	X X X

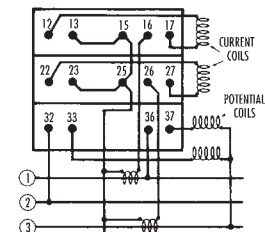

Order #
 Series 24 = 2420C includes NP 10D-2W14
 Series 31 = 3120C includes NP 31D-2W14

WATTMETER-Reversing Switch

Depth Behind Panel: 2.9"
 Handle: Round, Knurled
 Engraving and jumpering as shown

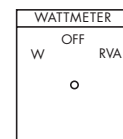

DECKS	CONTACTS	POS.
		OFF * ON
1	11-12 15-14 16-17	X X X
2	21-22 25-24 26-27	X X X

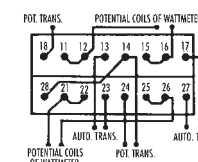

Order #
 Series 24 = 2421C includes NP 10C-3W16
 Series 31 = 3121C includes NP 31C-3W16



APPLICATION SPECIFIC SWITCHES

SERIES 24 AND SERIES 31 ROTARY SWITCHES

POWER-FACTOR-Switch

3-phase, two current-transformers,
one or two current-coils
Depth Behind Panel: 2.4"
Handle: Round, Knurled
Engraving and jumpering as shown

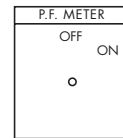

DECK	CONTACTS	POS.
1	2 0-1-1-0-1-3	OFF
	1 6 0-1-1-0-1-5	ON
	1 6 0-1-1-0-1-7	ON

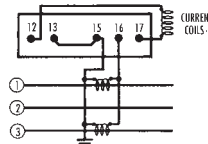

Order #
Series 24 = 2422C includes NP 10D-2P14
Series 31 = 3122C includes NP 31D-2P14

SYNCHRONIZING-Switch

Machine-to-bus with interlocks
Depth Behind Panel: 2.9"
Handle: Oval, Removable
Engraving and jumpering as shown

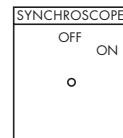

DECK	CONTACTS	POS.
1	1 2 0-1-1-0-1-3	OFF
	1 6 0-1-1-0-1-7	ON
	2 2 0-1-1-0-2-3	ON
2	2 6 0-1-1-0-2-7	ON

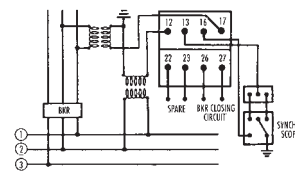

Order #
Series 24 = 2424E includes NP 11D-2S17

MOTOR CONTROL-Switch, Governor or Rheostat

Split-field motor
Depth Behind Panel: 2.4"
Handle: Pistol-Grip, Spring-Return
Engraving and jumpering as shown

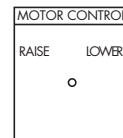

DECK	CONTACTS	POS.
1	11-12 0-1-1-0-1-8	RAISE
	1 6 0-1-1-0-1-3	LOWER
	15-16 0-1-1-0-1-4	LOWER
2	2 6 0-1-1-0-2-7	LOWER

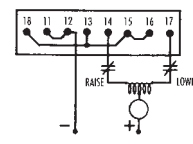

* Contacts 11-12 & 15-16 connected internally in normal position

Order #
Series 24 = 2427D includes NP 10B-2M22
Series 31 = 3127D includes NP 31B-2M22

TEMPERATURE METER- Transfer Switch

Transfers two wires to three coils,
with "TEST" and "OFF"
Depth Behind Panel: 2.9"
Handle: Round, Knurled
Engraving and jumpering as shown

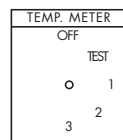

DECK	CONTACTS	POSITIONS
1	11 0-1-1-0-1-2	OFF
	11 0-1-1-0-1-3	TEST
	11 0-1-1-0-1-4	1
	11 0-1-1-0-1-5	2
	11 0-1-1-0-1-7	3
2	12 0-1-1-0-2-2	OFF
	12 0-1-1-0-2-3	TEST
	12 0-1-1-0-2-4	1
	12 0-1-1-0-2-5	2
	12 0-1-1-0-2-7	3

*Deck #2 MBB (shorting) contacts

Order #
Series 24 = 2432C includes NP 10D-5T19
Series 31 = 3132C includes NP 31D-5T19

CIRCUIT BREAKER- Trip Switch

Double-pole single-throw contacts
normally open
Depth Behind Panel: 2.4"
Handle: Pistol-Grip, Spring-Return
Engraving and jumpering as shown

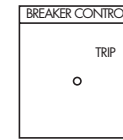

DECK	CONTACTS	POS.
1	1 2 0-1-1-0-1-3	TRIP
	1 6 0-1-1-0-1-7	TRIP or ALARM
	1 6 0-1-1-0-1-7	TRIP or ALARM

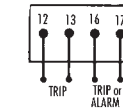

Order #
Series 24 = 2436D includes NP 10D-1B18

CIRCUIT BREAKER- Control Switches

Depth Behind Panel: 2.4"
Handle: Pistol-Grip, Spring-Return
Engraving and jumpering as shown

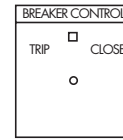

DECK	CONTACTS	POS.
1	1 1 0-1-1-0-1-8	TRIP
	1 6 0-1-1-0-1-7	TRIP
	1 6 0-1-1-0-1-7	CLOSE

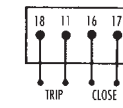

Order #
Series 24 = 2438D includes NP 18B-2B23

CIRCUIT BREAKER-Control Switches

Depth Behind Panel: 2.4"
Handle: Pistol-Grip, Spring-Return
Engraving and jumpering as shown

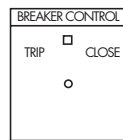

DECK	CONTACTS	POS.
1	12 0-1-1-0-1-3	TRIP
	15-16 0-1-1-0-1-4	TRIP
	1 6 0-1-1-0-1-7	CLOSE

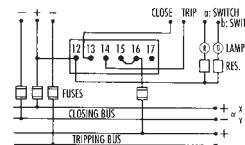

Note: Contacts 11-12 & 15-16 connected internally in normal position

Order #
Series 24 = 2440D includes NP 18B-2B23

Operate two breakers
Depth Behind Panel: 2.4"
Handle: Pistol-Grip, Spring-Return
Engraving and jumpering as shown

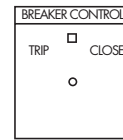

DECK	CONTACTS	POS.
1	11-12 0-1-1-0-1-3	TRIP
	15-16 0-1-1-0-1-4	TRIP
	1 6 0-1-1-0-1-7	CLOSE

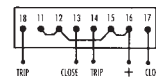

Note: Contacts 11-12 & 15-16 connected internally in normal position

Order #
Series 24 = 2441D includes NP 18B-2B23

Depth Behind Panel: 4.3"
Handle: Pistol-Grip, Spring-Return
Engraving and jumpering as shown

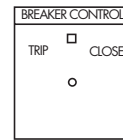

DECK	CONTACTS	POS.
1	11-12 0-1-1-0-1-3	TRIP
	15-16 0-1-1-0-1-4	TRIP
	1 6 0-1-1-0-1-7	CLOSE
2	22 0-1-1-0-2-3	TRIP
	26 0-1-1-0-2-7	TRIP
	26 0-1-1-0-2-7	CLOSE

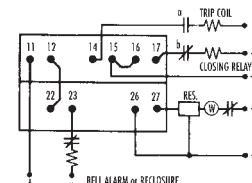

Note: Contacts 11-12 & 15-16 connected internally in normal position

Order #
Series 24 = 2442D includes NP 18B-2B23



APPLICATION SPECIFIC SWITCHES

SERIES 24 ROTARY SWITCHES

ELECTROSWITCH		SERIES 24 CONTROL SWITCHES		SWITCH NUMBER _____		REV _____																																																																																	
HANDLES <input type="checkbox"/> Oval <input type="checkbox"/> Knurled <input type="checkbox"/> Pistol-Grip <input type="checkbox"/> Removable in Pos _____ <input type="checkbox"/>		ACTIONS Maintained Spring-return to vertical <input type="checkbox"/> <input type="checkbox"/> ↗ <input type="checkbox"/> ↘ <input type="checkbox"/> ↕		OTHER FEATURES Panel Thickness _____ Depth behind panel _____ <input type="checkbox"/> Slip-contacts <input type="checkbox"/> Pull to Lock																																																																																			
SPECIAL FEATURES				HANDLE POSITIONS																																																																																			
				FOR BREAKER CONTROL SWITCH		FOR INSTRUMENT & CONTROL SWITCH																																																																																	
X-CHART FOR BREAKER CONTROL SWITCH		X-CHART FOR INSTRUMENT & CONTROL SWITCH		<table border="1" style="width:100%; border-collapse: collapse; text-align: center;"> <tr><td>11</td><td>12</td><td>13</td><td>14</td><td>15</td><td>16</td><td>17</td><td>18</td></tr> <tr><td>21</td><td>22</td><td>23</td><td>24</td><td>25</td><td>26</td><td>27</td><td>28</td></tr> <tr><td>31</td><td>32</td><td>33</td><td>34</td><td>35</td><td>36</td><td>37</td><td>38</td></tr> <tr><td>41</td><td>42</td><td>43</td><td>44</td><td>45</td><td>46</td><td>47</td><td>48</td></tr> <tr><td>51</td><td>52</td><td>53</td><td>54</td><td>55</td><td>56</td><td>57</td><td>58</td></tr> <tr><td>61</td><td>62</td><td>63</td><td>64</td><td>65</td><td>66</td><td>67</td><td>68</td></tr> <tr><td>71</td><td>72</td><td>73</td><td>74</td><td>75</td><td>76</td><td>77</td><td>78</td></tr> <tr><td>81</td><td>82</td><td>83</td><td>84</td><td>85</td><td>86</td><td>87</td><td>88</td></tr> <tr><td>91</td><td>92</td><td>93</td><td>94</td><td>95</td><td>96</td><td>97</td><td>98</td></tr> <tr><td>101</td><td>102</td><td>103</td><td>104</td><td>105</td><td>106</td><td>107</td><td>108</td></tr> </table> <p style="font-size: small;">SLIP CONTACTS WILL BE GROUPED AT REAR OF SWITCH</p> <p style="font-size: small;">TERMINAL NUMBERS ARE PRELIMINARY PENDING FACTORY REVIEW AND APPROVAL</p>				11	12	13	14	15	16	17	18	21	22	23	24	25	26	27	28	31	32	33	34	35	36	37	38	41	42	43	44	45	46	47	48	51	52	53	54	55	56	57	58	61	62	63	64	65	66	67	68	71	72	73	74	75	76	77	78	81	82	83	84	85	86	87	88	91	92	93	94	95	96	97	98	101	102	103	104	105	106	107	108
11	12	13	14					15	16	17	18																																																																												
21	22	23	24					25	26	27	28																																																																												
31	32	33	34					35	36	37	38																																																																												
41	42	43	44					45	46	47	48																																																																												
51	52	53	54					55	56	57	58																																																																												
61	62	63	64					65	66	67	68																																																																												
71	72	73	74					75	76	77	78																																																																												
81	82	83	84					85	86	87	88																																																																												
91	92	93	94					95	96	97	98																																																																												
101	102	103	104	105	106	107	108																																																																																
TITLE ENGRAVING:		TITLE ENGRAVING:																																																																																					
CONTACTS HANDLE END		CONTACTS HANDLE END																																																																																					
3 from		POSITIONS																																																																																					
1 2 2 4 4		1 2 3 4 5 6 7 8																																																																																					
*denotes make-before-break contact		*denotes make-before-break contact																																																																																					
● denotes terminal used SHOW JUMPERS TO BE SUPPLIED																																																																																							
MADE BY:	DATE:	COMPANY	DWG NO.																																																																																				
APPR BY:	DATE:		SHEET _____ OF _____																																																																																				



SERIES 20

MINIATURE INSTRUMENT AND CONTROL SWITCHES

Features

- Space Saving Design - Two Hole Panel Mount on 3" Centers
- Spring Loaded Cam Action Contacts
- Silver Plated Copper Surfaces for Long, Reliable Life
- M4-7 Terminal Screws for Easy Installation of #16AWG Wire
- NEMA Class A (105°C) Insulating Materials

Control Switch Special Features

- Mechanical Red/Green Target
- Slip Contacts for Alarm and Indicator Circuits
- Pull to Lock for Safety Lockout
- Spring Return to Normal (Vertical) Position

Instrument Switch Special Features

- Make-Before-Break (Shorting) Contacts
- Positive "Snappy" Positioning Detent Mechanism
- Pre-Wired Jumpers

Synchroscope Special Features

- Keyed Removable Oval Handles

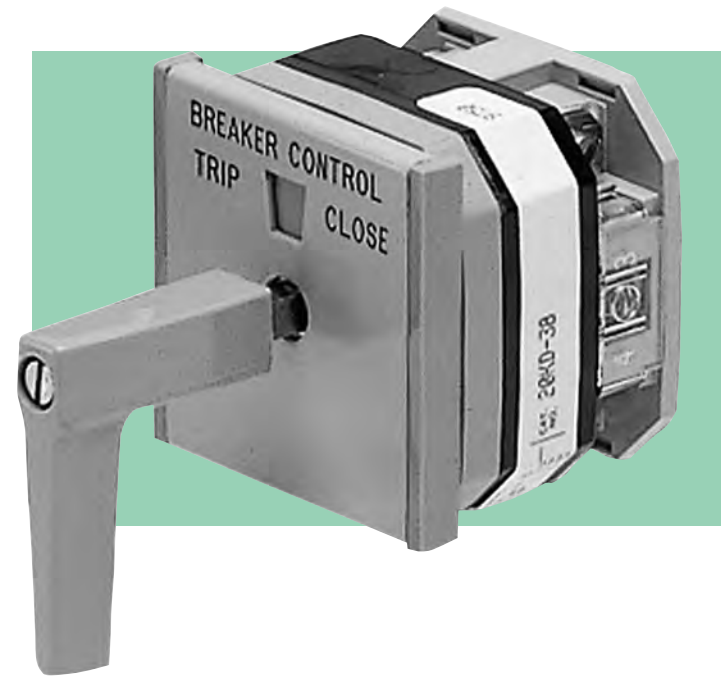

Electrical Specifications

Continuous Ratings

- 24A/600 Volts

Interrupt Ratings

- 3A/125VDC
- 20A/600VAC
- Momentary Current: 420 Amperes 1 Second
- Making Ability (Circuit Breaker Coils): 120A/125VDC
- Dielectric Strength: 2200V rms
- Insulation Resistance: 100 Megohms
- Contact Resistance: 10 Milliohms

Mechanical Specifications

Sections/Poles	1 to 12 /1 to 24
Positions	2 to 12
Contacts	Double Break Silver Plated Copper
Action	45°, 30°, 60° and 90° Positive Detent or Spring Return
Mounting	2 Hole
Panel Thickness	3/16" Max. Standard
Construction	Contacts Enclosed in Rigid Thermoset Plastic Housing
Special Drives	Key Operated

Approvals

- UL File No. E54035
- CSA Certified

Note: The Series 20 Class 1E utility products comply with the following Nuclear Standards: ANSI/IEEE C37.90, ANSI/IEEE C37.90.01, ANSI/IEEE C37.98, ANSI/IEEE C37.105, ANSI/IEEE 323, ANSI/IEEE 344, ANSI/ASME NQA -1.

ORDERING INFORMATION -

For generic switches fill out appropriate matrix pages 24-27. For special applications see page 28. For any other configurations not shown, consult factory.

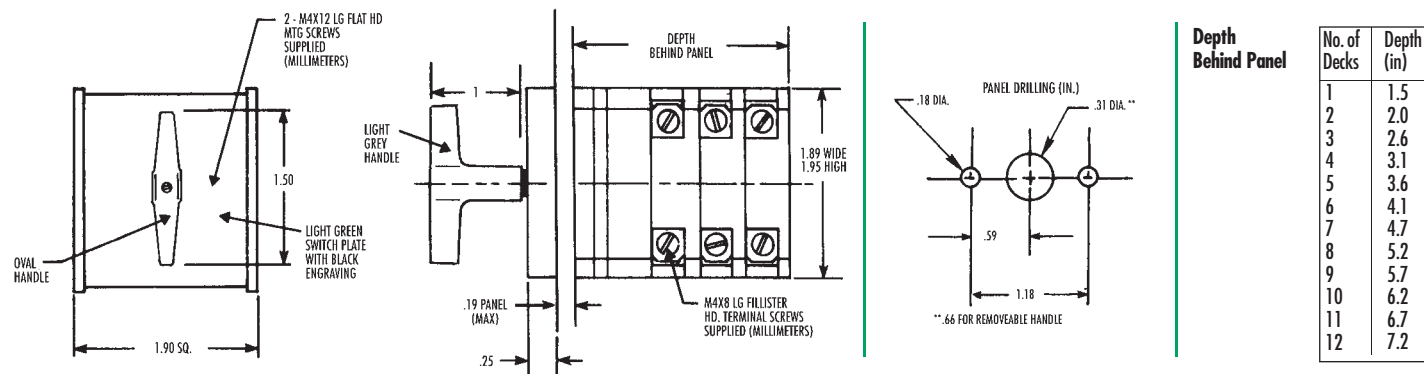



SERIES 20P

LIGHTED MINIATURE INSTRUMENT AND CONTROL SWITCHES

Features

Series 20P Lighted Switches have all the outstanding features of the Series 20 Switches; however, they also feature the following:

- 1, 2, or 3 Pre-wired Status Indicator Lamps — Red, Green, Amber or Other
- Easy, Inexpensive Front Panel Lamp Replacement
- Push to Test Lamp Holders
- Front Plate Only 2.94" Wide
- Assembly is Mounted from Front of Panel for Easy Wiring
- Can be Mounted with Switch Handle and Nameplate in Place
- Maintenance and Circuit Testing Accomplished from Front of Panel

Electrical Specifications

Continuous Ratings

- 24A/600 Volts

Interrupt Ratings

- 3A/125VDC
- 20A/600VAC
- Momentary Current: 420 Amperes 1 Second
- Making Ability (Circuit Breaker Coils) 120A/125VDC
- Dielectric Strength: 2200V rms
- Insulation Resistance: 100 Megohms
- Contact Resistance: 10 Milliohms

Lamp Voltage

- 24-28VDC
- LEDs Available

Lamp Life

- 10,000 Hours

Note: For ease of installation use #16 AWG Wire (or smaller). Larger wire may cause difficulty removing the switch from the front of the panel.

Approvals

- UL File No. E54035
- CSA Certified

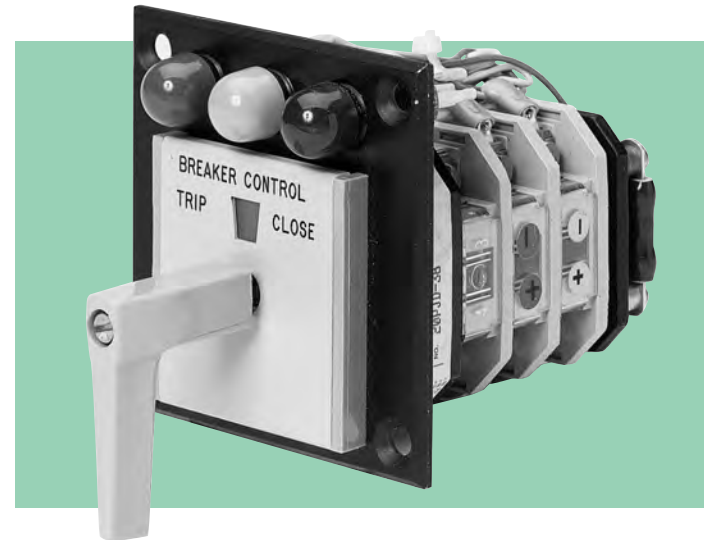

Mechanical Specifications

Sections/Poles	1 to 12 /1 to 24
Positions	2 to 12
Contacts	Double Break Silver Plated Copper
Action	45°, 30°, 60° and 90° Positive Detent or Spring Return
Mounting	4 Hole
Panel Thickness	3/16" Max. Standard
Construction	Contacts Enclosed in Rigid Thermoset Plastic Housing
Special Drives	Key Operated

Note: The Series 20P Class 1E utility products comply with the following Nuclear Standards: ANSI/IEEE C37.90, ANSI/IEEE C37.90.01, ANSI/IEEE C37.98, ANSI/IEEE C37.105, ANSI/IEEE 323, ANSI/IEEE 344, ANSI/ASME NQA -1.

ORDERING INFORMATION -

Specify Series 20 switches then: specify number, color, location and control voltage of lamps or LEDs.

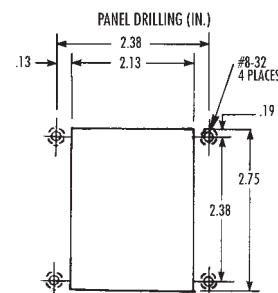
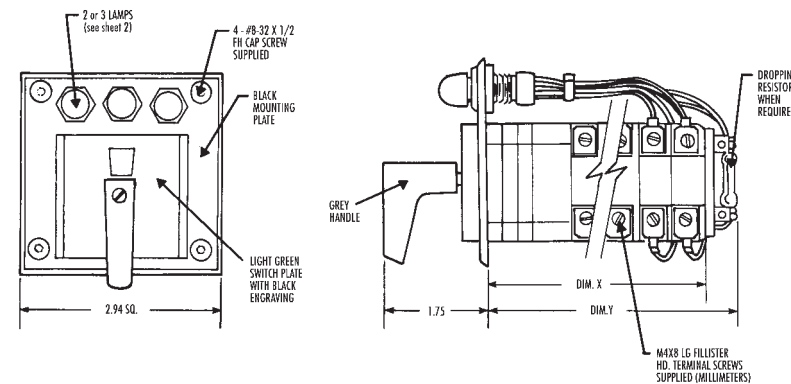

Depth Behind Panel

No. of Decks	Depth (in)			
	Dim X		Dim Y	
1	Spr. Ret. 2.5	Pull To Lock 3.0	Spr. Ret. 3.0	Pull To Lock 3.5
2	3.0	3.5	3.5	4.0
3	3.6	4.0	4.1	4.6
4	4.1	4.5	4.6	5.2
5	4.6	5.1	5.1	5.6
6	5.2	5.6	5.7	6.3
7	5.7	-	6.2	-
8	6.2	-	6.7	-

Add 0.7" for Slip Contacts



SERIES 20M

MODULAR PLUG-IN INSTRUMENT AND CONTROL SWITCHES

Features

Series 20 Modular Plug-In Instrument & Control Switches have all the outstanding features of the Series 20 and 20P Switches with the following additions:

- Modular Design — Lighted or Nonlighted
- Plug-in Quick Disconnect Capabilities
- Front of Panel Serviceable Without Service Loops
- Integral Indicating and Annunciator Lights — With or Without Dropping Resistors
- Integrated Markings for Better Control — Engravings for Title, Lamps and Identification Tagging
- Choice of Handles
- Can be Mounted with Switch Handle and Nameplate in Place
- Maintenance and Circuit Testing Accomplished from Front of Panel
- Burndy Bantamate Military Style Connectors
- 3 Lamp Styles — Round Dome, Round-Flat, Dome LEDs

Electrical Specifications

Continuous Ratings

- 20A/240 Volts

Interrupt Ratings

- 20A/120VAC
- 20A/240VAC
- 20A/24VDC
- Momentary Current: 407 Amperes 1 Second
- Overload Current (50 operations): 91A/240VAC
- Dielectric Strength: 1500V rms
- Insulation Resistance: 100 Megohms
- Contact Resistance: 10 Milliohms

Mechanical Specifications

Sections/Poles	1 to 12 /1 to 24
Positions	2 to 12
Contacts	Double Break Silver Plated Copper
Action	45°, 30°, 60° and 90° Positive Detent or Spring Return
Mounting	Modular
Panel Thickness	2.5" Max. Standard
Construction	Contacts Enclosed in Rigid Thermoset Plastic Housing
Special Drives	Key Operated



Plug-in Connectors

Burndy Bantamate Trim Trio round connectors are standard. Generally only one connector is needed and the "N" polarization is used.

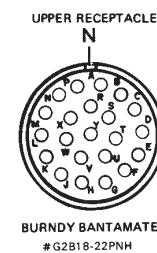

Note: The Series 20M Class 1E utility products comply with the following Nuclear Standards: ANSI/IEEE C37.90, ANSI/IEEE C37.90.01, ANSI/IEEE C37.98, ANSI/IEEE C37.105, ANSI/IEEE 323, ANSI/IEEE 344, ANSI/ASME NQA -1.

ORDERING INFORMATION

Specify Series 20 switch, number, color and voltage of lamps and engraving.

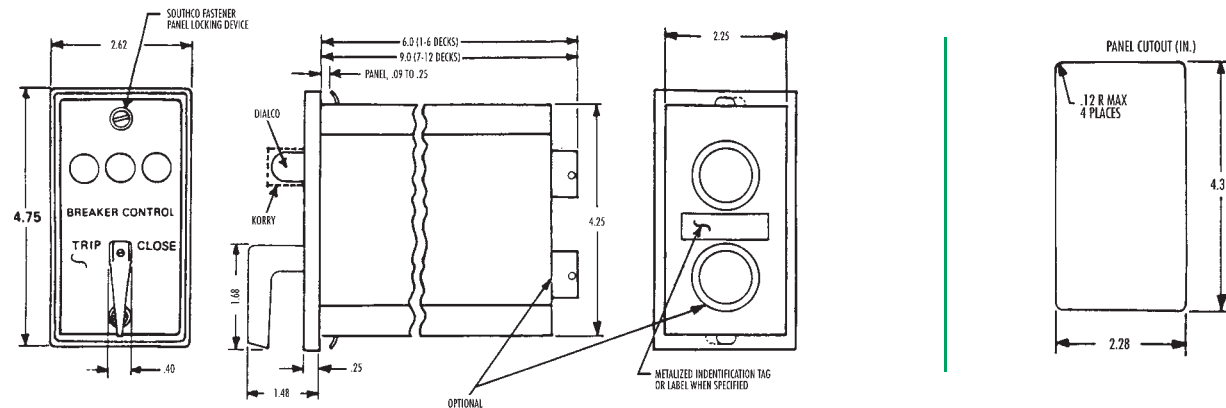



DESIGN A SWITCH TO MEET YOUR NEEDS

SERIES 20 AND 20P INSTRUMENT AND CONTROL SWITCHES

Description Indexing Contact Diagram Ordering Information

Detent and Momentary Action Rotary Switches

SINGLE-THROW OFF - ON

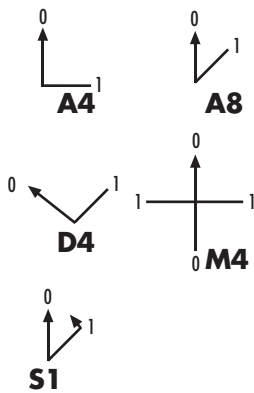

DECKS	CONTACTS	POS.	
		0	1
1	1 —○— — —○ 2		X
	3 —○— — —○ 4		X
2	5 —○— — —○ 6		X
	7 —○— — —○ 8		X

For momentary action.
Up to six poles, specify S1 indexing.

20K -11

Handle	No. Of Poles		Indexing
B = Oval Shank	01 = 1	12 = 12	A4 = A4
C = Round Knurled	02 = 2	14 = 14	A8 = A8
D = Pistol-Grip	03 = 3	16 = 16	D4 = D4
E = Removable	04 = 4	18 = 18	M4 = M4
	05 = 5	20 = 20	S1 = S1
	06 = 6	22 = 22	(momentary)
	08 = 8	24 = 24	(see indexing at left)
	10 = 10		

DOUBLE-THROW No Off

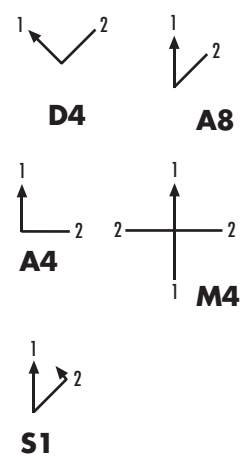

DECKS	CONTACTS	POS.	
		1	2
1	1 —○— — —○ 2	X	
	3 —○— — —○ 4	X	
2	5 —○— — —○ 6	X	
	7 —○— — —○ 8	X	
3	9 —○— — —○ 10	X	
	11 —○— — —○ 12	X	
4	13 —○— — —○ 14	X	
	15 —○— — —○ 16	X	

For momentary action.
Up to six poles, specify S1 indexing.

20K -22

Handle	No. Of Poles		Indexing
B = Oval Shank	51 = 1	57 = 7	A4 = A4
C = Round Knurled	52 = 2	58 = 8	A8 = A8
D = Pistol-Grip	53 = 3	59 = 9	D4 = D4
E = Removable	54 = 4	60 = 10	M4 = M4
	55 = 5	61 = 11	S1 = S1
	56 = 6	62 = 12	(momentary)
			(see indexing at left)

DOUBLE-THROW With Off

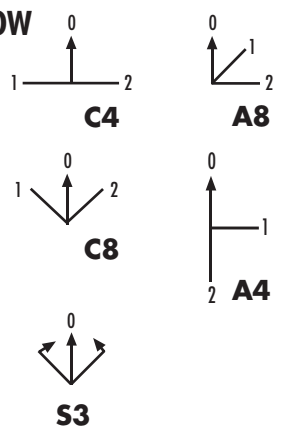

DECKS	CONTACTS	POS.		
		1	0	2
1	1 —○— — —○ 2	X		
	3 —○— — —○ 4			X
2	5 —○— — —○ 6	X		
	7 —○— — —○ 8			X

For momentary action.
Up to six poles, specify S3 indexing.

20K -22

Handle	No. Of Poles		Indexing
B = Oval Shank	01 = 1	07 = 7	A4 = A4
C = Round Knurled	02 = 2	08 = 8	A8 = A8
D = Pistol-Grip	03 = 3	09 = 9	C4 = C4
E = Removable	04 = 4	10 = 10	C8 = C8
	05 = 5	11 = 11	S3 = S3
	06 = 6	12 = 12	(momentary)
			(see indexing at left)



DESIGN A SWITCH TO MEET YOUR NEEDS

SERIES 20 ROTARY SWITCHES

Description Indexing Contact Diagram Ordering Information

Maintained Action Rotary Switches

SIX-THROW

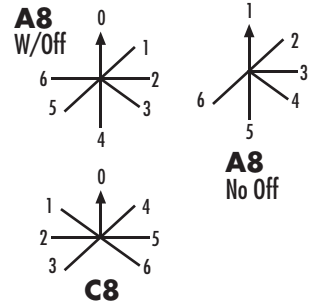

DECKS	CONTACTS	POS.						
		0	1	2	3	4	5	6
1	1-2, 3-4	X						
2	5-6, 7-8		X					
3	9-10, 11-12			X				

20K **-26**

Handle — On / Off — No. Of — Indexing
 B = Oval Shank 0 = W/Off Poles A8 = A8
 C = Round Knurled 5 = No Off 1 = 1 C8 = C8
 D = Pistol-Grip 2 = 2 (see at left)
 E = Removable 3 = 3
 4 = 4

SEVEN -THROW

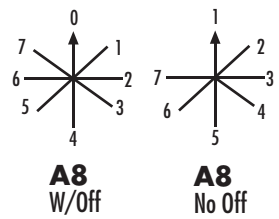

DECKS	CONTACTS	POS.							
		0	1	2	3	4	5	6	7
1	1-2, 3-4	X							
2	5-6, 7-8		X						
3	9-10, 11-12			X					
4	13-14, 15-16				X				
5	17-18, 19-20					X			
6	21-22, 23-24						X		
7	25-26, 27-28							X	

20K **-27**

Handle — On / Off — No. Of — Indexing
 B = Oval Shank 0 = W/Off Poles A8 = A8
 C = Round Knurled 5 = No Off 1 = 1 (see at left)
 D = Pistol-Grip 2 = 2
 E = Removable 3 = 3

EIGHT-THROW

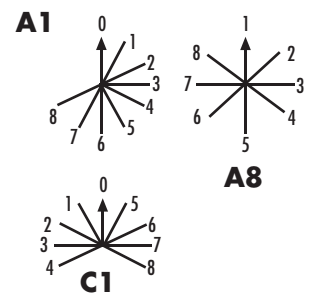

DECKS	CONTACTS	POS.								
		0	1	2	3	4	5	6	7	8
1	1-2, 3-4	X								
2	5-6, 7-8		X							
3	9-10, 11-12			X						
4	13-14, 15-16				X					

20K **-28**

Handle — On / Off — No. Of — Indexing
 B = Oval Shank 0 = W/Off Poles A1 = A1
 C = Round Knurled 5 = No Off 1 = 1 A8 = A8
 D = Pistol-Grip 2 = 2 C1 = C1
 E = Removable 3 = 3 (see at left)

NINE-THROW

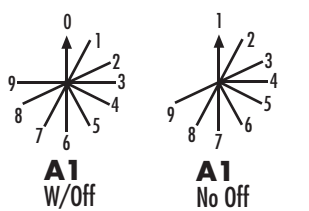

DECKS	CONTACTS	POS.									
		0	1	2	3	4	5	6	7	8	9
1	1-2, 3-4	X									
2	5-6, 7-8		X								
3	9-10, 11-12			X							
4	13-14, 15-16				X						
5	17-18, 19-20					X					
6	21-22, 23-24						X				
7	25-26, 27-28							X			
8	29-30, 31-32								X		
9	33-34, 35-36									X	

20K **-29** **-A1**

Handle — On / Off — No. Of — Indexing
 B = Oval Shank 0 = W/Off Poles A1 = A1
 C = Round Knurled 5 = No Off 1 = 1 (see at left)
 D = Pistol-Grip 2 = 2
 E = Removable



DESIGN A SWITCH TO MEET YOUR NEEDS

SERIES 20 ROTARY SWITCHES

Description Indexing Contact Diagram Ordering Information

Maintained Action Rotary Switches

TEN-THROW

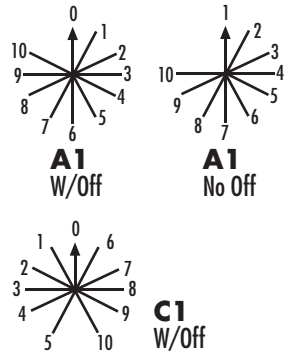

DECKS	CONTACTS	POS.										
		0	1	2	3	4	5	6	7	8	9	10
1	1-2	X										
2	3-4		X									
3	5-6			X								
4	7-8				X							
5	9-10					X						
6	11-12						X					
7	13-14							X				
8	15-16								X			
9	17-18									X		
10	19-20										X	

20K -40

Handle On / Off No. Of Poles Indexing
 B = Oval Shank 0 = W/Off 1 = 1 A1 = A1
 C = Round Knurled 5 = No Off 2 = 2 C1 = C1
 D = Pistol-Grip
 E = Removable (see at left)

ELEVEN -THROW

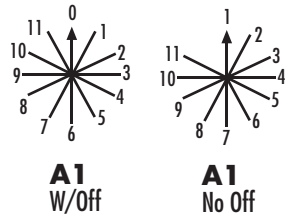

DECKS	CONTACTS	POS.																					
		0	1	2	3	4	5	6	7	8	9	10	11										
1	1-2	X																					
2	3-4		X																				
3	5-6			X																			
4	7-8				X																		
5	9-10					X																	
6	11-12						X																
7	13-14							X															
8	15-16								X														
9	17-18									X													
10	19-20										X												
11	21-22											X											
12	23-24												X										
13	25-26													X									
14	27-28														X								
15	29-30															X							
16	31-32																X						
17	33-34																	X					
18	35-36																		X				
19	37-38																			X			
20	39-40																				X		
21	41-42																					X	
22	43-44																						X

20K -41 -A1

Handle On / Off No. Of Poles Indexing
 B = Oval Shank 0 = W/Off 1 = 1 A1 = A1
 C = Round Knurled 5 = No Off 2 = 2 (see at left)

TWELVE-THROW

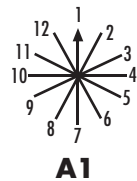

DECKS	CONTACTS	POS.											
		1	2	3	4	5	6	7	8	9	10	11	12
1	1-2	X											
2	3-4		X										
3	5-6			X									
4	7-8				X								
5	9-10					X							
6	11-12						X						
7	13-14							X					
8	15-16								X				
9	17-18									X			
10	19-20										X		
11	21-22											X	
12	23-24												X

20K -42 -A1

Handle No. Of Poles Indexing
 B = Oval Shank 51 = 1 A1 = A1
 C = Round Knurled 52 = 2 (see at left)
 D = Pistol-Grip
 E = Removable



APPLICATION SPECIFIC SWITCHES

SERIES 20 ROTARY SWITCHES

VOLTMETER -Transfer Switches

2-wire, single-phase or D.C.
Depth Behind Panel: 1.5"
Handle: Round, Knurled
Engraving and jumpering as shown

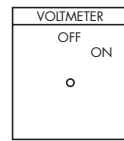

DECK	CONTACTS	POS.
1	1-2	OFF
1	3-4	ON

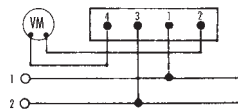

Order #
20KC-01 includes NP 53D-2V14

4-wire, two-phase or two separate D.C. circuits
Depth Behind Panel: 2.0"
Handle: Round, Knurled
Engraving and jumpering as shown

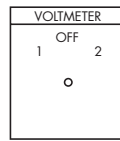

DECKS	CONTACTS	POS.
1	1-2	1,2
1	3-4	3,4
2	5-6	5,6
2	7-8	7,8

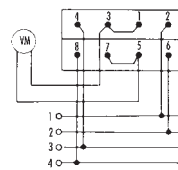

Order #
20KC-02 includes NP 53C-3V14

3-phase, phase-to-neutral
Depth Behind Panel: 2.0"
Handle: Round, Knurled
Engraving and jumpering as shown

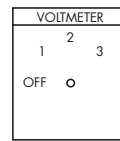

DECKS	CONTACTS	POS.
1	1-2	1
1	3-4	2
2	5-6	3
2	7-8	OFF

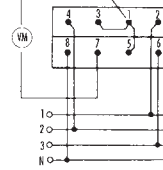

Order #
20KC-03 includes NP 53C-4V15A

VOLTMETER -Transfer Switches

3-phase, phase-to-phase
Depth Behind Panel: 2.0"
Handle: Round, Knurled
Engraving and jumpering as shown

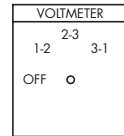

DECKS	CONTACTS	POS.
1	1-2	1-2
1	3-4	2-3
2	5-6	3-1
2	7-8	OFF

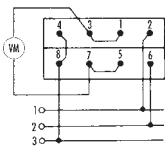

Order #
20KC-04 includes NP 53C-4V21

3-phase, phase-to-phase and phase-to-neutral
Depth Behind Panel: 2.6"
Handle: Round, Knurled
Engraving and jumpering as shown

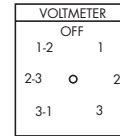

DECKS	CONTACTS	POS.
1	1-2	1-2
1	3-4	2-3
2	5-6	3-1
2	7-8	1
3	9-10	2
3	11-12	3

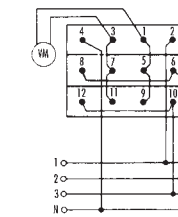

Order #
20KC-05 includes NP 53E-7V24

6-wire, two 3-phase circuits; phase-to-phase
Depth Behind Panel: 3.1"
Handle: Round, Knurled
Engraving and jumpering as shown

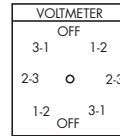

DECKS	CONTACTS	POS.
1	1-2	1-2
1	3-4	2-3
2	5-6	3-1
2	7-8	1-2
3	9-10	2-3
3	11-12	3-1
4	13-14	1-2
4	15-16	2-3

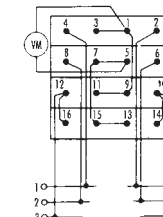

Order #
20KC-06 includes NP 53E-8V33

AMMETER- Transfer Switches

3-phase, two current-transformers
Depth Behind Panel: 2.0"
Handle: Round, Knurled
Engraving and jumpering as shown

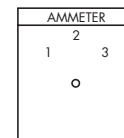

DECKS	CONTACTS	POS.
1	1-2	*1 *2 *3
2	3-4	*1 *2 *3
2	5-6	*1 *2 *3
2	7-8	*1 *2 *3

*Denotes make-before-break

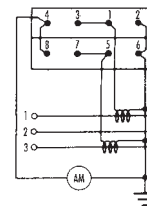

Order #
20KC-07 includes NP 53C-3A10A

3-phase, two current-transformers
Depth Behind Panel: 2.0"
Handle: Round, Knurled
Engraving and jumpering as shown

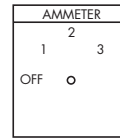

DECKS	CONTACTS	POS.
1	1-2	*1 *2 *3
1	3-4	*1 *2 *3
2	5-6	*1 *2 *3
2	7-8	*1 *2 *3

*Denotes make-before-break

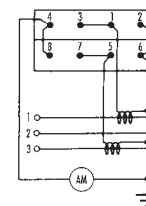

Order #
20KC-08 includes NP 53C-4A13

3-phase, three current-transformers
Depth Behind Panel: 2.6"
Handle: Round, Knurled
Engraving and jumpering as shown

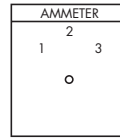

DECKS	CONTACTS	POS.
1	1-2	*1 *2 *3
1	3-4	*1 *2 *3
2	5-6	*1 *2 *3
2	7-8	*1 *2 *3
3	9-10	*1 *2 *3
3	11-12	*1 *2 *3

*Denotes make-before-break

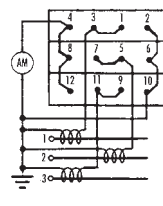

Order #
20KC-09 includes NP 53C-3A10A



APPLICATION SPECIFIC SWITCHES

SERIES 20 ROTARY SWITCHES

AMMETER-Transfer Switches

3-phase, three current-transformers
 Depth Behind Panel: 2.6"
 Handle: Round, Knurled
 Engraving and jumpering as shown

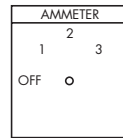

DECKS	CONTACTS	POS.
1	1-2, 3-4, 5-6, 7-8, 9-10, 11-12	1, 2, 3
2	1-2, 3-4, 5-6, 7-8, 9-10, 11-12	1, 2, 3
3	1-2, 3-4, 5-6, 7-8, 9-10, 11-12	1, 2, 3

*Denotes make-before-break

Order #
 20KC-10 includes NP 53C-4A13

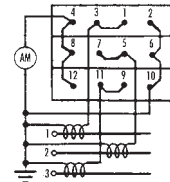

3-phase, three current-transformers, three independent circuits

Depth Behind Panel: 4.1"
 Handle: Round, Knurled
 Engraving and jumpering as shown

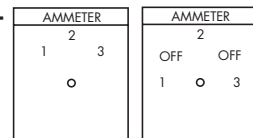

For 20KC-11

For 20KC-12

DECKS	CONTACTS	POS.
1	1-2, 3-4, 5-6, 7-8, 9-10, 11-12, 13-14, 15-16, 17-18, 19-20, 21-22, 23-24	1, 2, 3
2	1-2, 3-4, 5-6, 7-8, 9-10, 11-12, 13-14, 15-16, 17-18, 19-20, 21-22, 23-24	1, 2, 3
3	1-2, 3-4, 5-6, 7-8, 9-10, 11-12, 13-14, 15-16, 17-18, 19-20, 21-22, 23-24	1, 2, 3
4	1-2, 3-4, 5-6, 7-8, 9-10, 11-12, 13-14, 15-16, 17-18, 19-20, 21-22, 23-24	1, 2, 3
5	1-2, 3-4, 5-6, 7-8, 9-10, 11-12, 13-14, 15-16, 17-18, 19-20, 21-22, 23-24	1, 2, 3
6	1-2, 3-4, 5-6, 7-8, 9-10, 11-12, 13-14, 15-16, 17-18, 19-20, 21-22, 23-24	1, 2, 3

*Denotes make-before-break

Order #
 20KC-11 includes NP 53A-3A10
 20KC-12 includes NP 53C-5A16

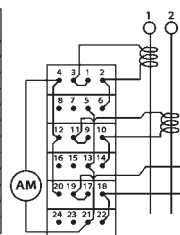

AMMETER-VOLTMETER Transfer Switch

3-phase, phase-to-phase, three current-transformers
 Depth Behind Panel: 3.6"
 Handle: Round, Knurled
 Engraving and jumpering as shown

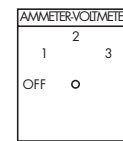

DECKS	CONTACTS	POS.
1	1-2, 3-4, 5-6, 7-8, 9-10, 11-12, 13-14, 15-16, 17-18, 19-20, 21-22, 23-24	1, 2, 3
2	1-2, 3-4, 5-6, 7-8, 9-10, 11-12, 13-14, 15-16, 17-18, 19-20, 21-22, 23-24	1, 2, 3
3	1-2, 3-4, 5-6, 7-8, 9-10, 11-12, 13-14, 15-16, 17-18, 19-20, 21-22, 23-24	1, 2, 3
4	1-2, 3-4, 5-6, 7-8, 9-10, 11-12, 13-14, 15-16, 17-18, 19-20, 21-22, 23-24	1, 2, 3
5	1-2, 3-4, 5-6, 7-8, 9-10, 11-12, 13-14, 15-16, 17-18, 19-20, 21-22, 23-24	1, 2, 3

*Denotes make-before-break

Order #
 20KC-15 includes NP 53C-4A23C

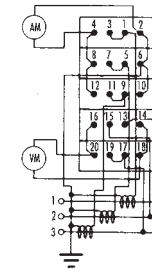

WATTMETER-Transfer Switch

3-phase, three current-transformers, three current-coils
 Depth Behind Panel: 3.6"
 Handle: Round, Knurled
 Engraving and jumpering as shown

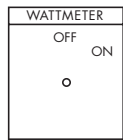

DECKS	CONTACTS	POS.
1	1-2, 3-4, 5-6, 7-8, 9-10, 11-12, 13-14, 15-16, 17-18, 19-20, 21-22, 23-24	1, 2, 3
2	1-2, 3-4, 5-6, 7-8, 9-10, 11-12, 13-14, 15-16, 17-18, 19-20, 21-22, 23-24	1, 2, 3
3	1-2, 3-4, 5-6, 7-8, 9-10, 11-12, 13-14, 15-16, 17-18, 19-20, 21-22, 23-24	1, 2, 3
4	1-2, 3-4, 5-6, 7-8, 9-10, 11-12, 13-14, 15-16, 17-18, 19-20, 21-22, 23-24	1, 2, 3
5	1-2, 3-4, 5-6, 7-8, 9-10, 11-12, 13-14, 15-16, 17-18, 19-20, 21-22, 23-24	1, 2, 3

*Denotes make-before-break

Order #
 20KC-19 includes NP 53D-2W14

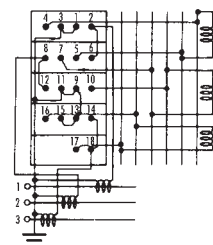

3-phase, two current-transformers, two current-coils, two potential coils
 Depth Behind Panel: 3.1"
 Handle: Round, Knurled
 Engraving and jumpering as shown

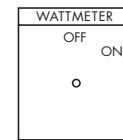

DECKS	CONTACTS	POS.
1	1-2, 3-4, 5-6, 7-8, 9-10, 11-12, 13-14, 15-16, 17-18, 19-20, 21-22, 23-24	1, 2, 3
2	1-2, 3-4, 5-6, 7-8, 9-10, 11-12, 13-14, 15-16, 17-18, 19-20, 21-22, 23-24	1, 2, 3
3	1-2, 3-4, 5-6, 7-8, 9-10, 11-12, 13-14, 15-16, 17-18, 19-20, 21-22, 23-24	1, 2, 3
4	1-2, 3-4, 5-6, 7-8, 9-10, 11-12, 13-14, 15-16, 17-18, 19-20, 21-22, 23-24	1, 2, 3

*Denotes make-before-break

Order #
 20KC-20 includes NP 53D-2W14

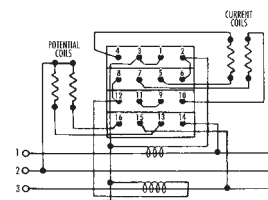

WATTMETER-Reversing Switch

Depth Behind Panel: 3.1"
 Handle: Round, Knurled
 Engraving and jumpering as shown

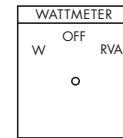

DECKS	CONTACTS	POS.
1	1-2, 3-4, 5-6, 7-8, 9-10, 11-12, 13-14, 15-16, 17-18, 19-20, 21-22, 23-24	W, OFF, RVA
2	1-2, 3-4, 5-6, 7-8, 9-10, 11-12, 13-14, 15-16, 17-18, 19-20, 21-22, 23-24	W, OFF, RVA
3	1-2, 3-4, 5-6, 7-8, 9-10, 11-12, 13-14, 15-16, 17-18, 19-20, 21-22, 23-24	W, OFF, RVA
4	1-2, 3-4, 5-6, 7-8, 9-10, 11-12, 13-14, 15-16, 17-18, 19-20, 21-22, 23-24	W, OFF, RVA

Order #
 20KC-21 includes NP 53C-3W16

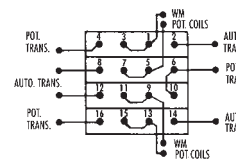

POWER-FACTOR-Switch

3-phase, two current-transformers, one or two current-coils
 Depth Behind Panel: 2.0"
 Handle: Round, Knurled
 Engraving and jumpering as shown

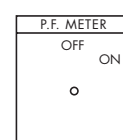

DECKS	CONTACTS	POS.
1	1-2, 3-4, 5-6, 7-8, 9-10, 11-12, 13-14, 15-16, 17-18, 19-20, 21-22, 23-24	1, 2, 3
2	1-2, 3-4, 5-6, 7-8, 9-10, 11-12, 13-14, 15-16, 17-18, 19-20, 21-22, 23-24	1, 2, 3

*Denotes make-before-break

Order #
 20KC-22 includes NP 53D-2P14

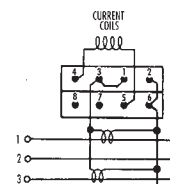

SYNCHRONIZING-Switch

Machine-to-bus with interlocks
 Depth Behind Panel: 2.7"
 Handle: Oval, Removable
 Engraving and jumpering as shown

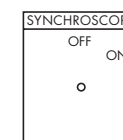

DECKS	CONTACTS	POS.
1	1-2, 3-4, 5-6, 7-8, 9-10, 11-12, 13-14, 15-16, 17-18, 19-20, 21-22, 23-24	1, 2, 3
2	1-2, 3-4, 5-6, 7-8, 9-10, 11-12, 13-14, 15-16, 17-18, 19-20, 21-22, 23-24	1, 2, 3

Order #
 20KE-24 includes NP 54D-2S17

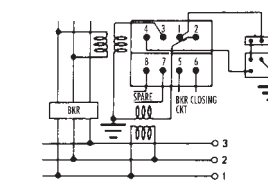

MOTOR CONTROL-Switch, Governor or Rheostat

Split-field motor
 Depth Behind Panel: 1.5"
 Handle: Pistol-Grip
 Action: Spring-Return to Vertical
 Engraving and jumpering as shown

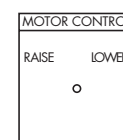

DECKS	CONTACTS	POS.
1	1-2, 3-4, 5-6, 7-8, 9-10, 11-12, 13-14, 15-16, 17-18, 19-20, 21-22, 23-24	RAISE, LOWER

Order #
 20KD-27 includes NP 53B-2M22

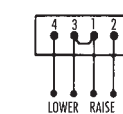



APPLICATION SPECIFIC SWITCHES

SERIES 20 ROTARY SWITCHES

TEMPERATURE METER-Transfer Switch

Transfers two wires to three coils with "TEST" and "OFF"
 Depth Behind Panel: 3.1"
 Handle: Round, Knurled
 Engraving and jumpering as shown

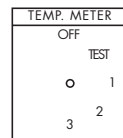

DECKS	CONTACTS	POS.
1	1 0-1-1-0 2 3 0-1-1-0 4	1 * 2 * 3
2	5 0-1-1-0 6 7 0-1-1-0 8	
3	9 0-1-1-0 10 11 0-1-1-0 12	
4	13 0-1-1-0 14 15 0-1-1-0 16	

*Denotes make-before-break
Order #
 20KC-32 includes NP 53D-5T19

CIRCUIT BREAKER-Trip Switch

Double-pole single-throw contacts normally open
 Depth Behind Panel: 1.5"
 Handle: Pistol-Grip
 Action: Spring-Return
 Engraving and jumpering as shown

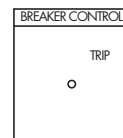

DECK	CONTACTS	POS.
1	1 0-1-1-0 2 3 0-1-1-0 4	TRIP

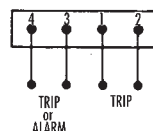

Order #
 20KD-36 includes NP 53D-1B18

CIRCUIT BREAKER-Control Switch

Depth Behind Panel: 1.5"
 Handle: Pistol-Grip
 Action: Spring-Return
 Engraving and jumpering as shown

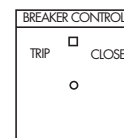

DECK	CONTACTS	POS.
1	1 0-1-1-0 2 3 0-1-1-0 4	TRIP CLOSE

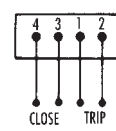

Order #
 20KD-38 includes NP 55B-2B23

CIRCUIT BREAKER-Control Switches

Depth Behind Panel: 2.0"
 Handle: Pistol-Grip
 Action: Spring-Return
 Engraving and jumpering as shown

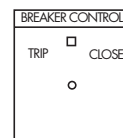

DECKS	CONTACTS	POS.
1	1 0-1-1-0 2 3 0-1-1-0 4	TRIP NORMAL CLOSE
2	5 0-1-1-0 6 7 0-1-1-0 8	

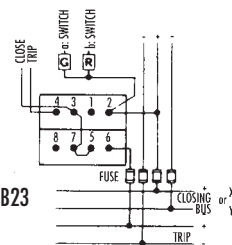

Order #
 20KD-40 includes NP 55B-2B23

Operate two breakers
 Depth Behind Panel: 2.6"
 Handle: Pistol-Grip
 Action: Spring-Return
 Engraving and jumpering as shown

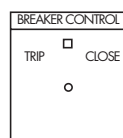

DECKS	CONTACTS	POS.
1	1 0-1-1-0 2 3 0-1-1-0 4	TRIP NORMAL CLOSE
2	5 0-1-1-0 6 7 0-1-1-0 8	
3	9 0-1-1-0 10 11 0-1-1-0 12	

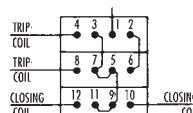

Order #
 20KD-41 includes NP 55B-2B23

Depth Behind Panel: 3.2"
 Handle: Pistol-Grip
 Action: Spring-Return
 Engraving and jumpering as shown

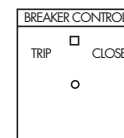

DECKS	CONTACTS	POS.
1	1 0-1-1-0 2 3 0-1-1-0 4	TRIP NORMAL CLOSE
2	5 0-1-1-0 6 7 0-1-1-0 8	
3	9 0-1-1-0 10 11 0-1-1-0 12	

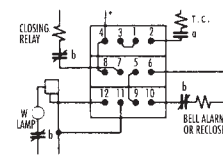

NAT = Normal after Trip
 NAC = Normal after Close
Order #
 20KD-42 includes NP 55B-2B23

CIRCUIT BREAKER-Control Switches

Depth Behind Panel: 3.7"
 Handle: Pistol-Grip
 Action: Spring-Return
 Engraving and jumpering as shown

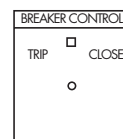

DECKS	CONTACTS	POS.
1	1 0-1-1-0 2 3 0-1-1-0 4	TRIP NORMAL CLOSE
2	5 0-1-1-0 6 7 0-1-1-0 8	
3	9 0-1-1-0 10 11 0-1-1-0 12	
4	13 0-1-1-0 14 15 0-1-1-0 16	

NAT = Normal after Trip
 NAC = Normal after Close

Order #
 20KD-43 includes NP 55B-2B23

Depth Behind Panel: 3.2"
 Handle: Pistol-Grip
 Action: Spring-Return
 Engraving and jumpering as shown

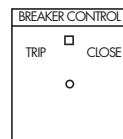

DECKS	CONTACTS	POS.
1	1 0-1-1-0 2 3 0-1-1-0 4	TRIP NORMAL CLOSE
2	5 0-1-1-0 6 7 0-1-1-0 8	
3	9 0-1-1-0 10 11 0-1-1-0 12	

NAT = Normal after Trip
 NAC = Normal after Close

Order #
 20KD-44 includes NP 55B-2B23

Depth Behind Panel: 3.7"
 Handle: Pistol-Grip
 Action: Spring-Return
 Engraving and jumpering as shown

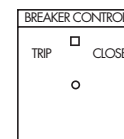

DECKS	CONTACTS	POS.
1	1 0-1-1-0 2 3 0-1-1-0 4	TRIP NORMAL CLOSE
2	5 0-1-1-0 6 7 0-1-1-0 8	
3	9 0-1-1-0 10 11 0-1-1-0 12	
4	13 0-1-1-0 14 15 0-1-1-0 16	

NAT = Normal after Trip
 NAC = Normal after Close

Order #
 20KD-45 includes NP 55B-2B23



APPLICATION SPECIFIC SWITCHES

SERIES 20 ROTARY SWITCHES

CIRCUIT BREAKER-Control Switches

Depth Behind Panel: 3.7"
 Handle: Pistol-Grip
 Action: Spring-Return
 Engraving and jumpering as shown

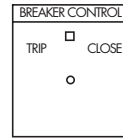

DECS	CONTACTS	POS.		
		TRIP	TRIP	TRIP
1	1 0-1-1-0-2			
	3 0-1-1-0-4			
2	5 0-1-1-0-6			
	7 0-1-1-0-8			
3	9 0-1-1-0-10			
	11 0-1-1-0-12			
4	13 0-1-1-0-14			
	15 0-1-1-0-16			

Order #
 20KD-46 includes NP 55B-2B23

Depth Behind Panel: 2.5"
 Handle: Pistol-Grip
 Action: Spring-Return, Pull to lock
 Engraving and jumpering as shown

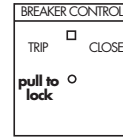

DECS	CONTACTS	POS.		
		TRIP	TRIP	TRIP
1	1 0-1-1-0-2			
	3 0-1-1-0-4			
2	5 0-1-1-0-6			
	7 0-1-1-0-8			

Order #
 20KD-50 includes NP 55C-3B33

Depth Behind Panel: 4.2"
 Handle: Pistol-Grip
 Action: Spring-Return, Pull to lock
 Engraving and jumpering as shown

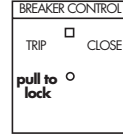

DECS	CONTACTS	POS.		
		TRIP	TRIP	TRIP
1	1 0-1-1-0-2			
	3 0-1-1-0-4			
2	5 0-1-1-0-6			
	7 0-1-1-0-8			
3	9 0-1-1-0-10			
	11 0-1-1-0-12			
4	13 0-1-1-0-14			
	15 0-1-1-0-16			

Order #
 20KD-52 includes NP 55C-3B33

CIRCUIT BREAKER-Control Switches

Universal Circuit
 Depth Behind Panel: 4.2"
 Handle: Pistol-Grip
 Action: Spring-Return
 Engraving and jumpering as shown

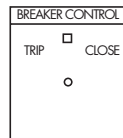

DECS	CONTACTS	POS.		
		TRIP	TRIP	TRIP
1	1 0-1-1-0-2			
	3 0-1-1-0-4			
2	5 0-1-1-0-6			
	7 0-1-1-0-8			
3	9 0-1-1-0-10			
	11 0-1-1-0-12			
4	13 0-1-1-0-14			
	15 0-1-1-0-16			
5	17 0-1-1-0-18			
	19 0-1-1-0-20			

Order #
 20KD-57 includes NP 55B-2B23

Universal Circuit
 Depth Behind Panel: 5.2"
 Handle: Pistol-Grip
 Action: Spring-Return, Pull to lock
 Engraving and jumpering as shown

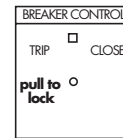

DECS	CONTACTS	POS.		
		TRIP	TRIP	TRIP
1	1 0-1-1-0-2			
	3 0-1-1-0-4			
2	5 0-1-1-0-6			
	7 0-1-1-0-8			
3	9 0-1-1-0-10			
	11 0-1-1-0-12			
4	13 0-1-1-0-14			
	15 0-1-1-0-16			
5	17 0-1-1-0-18			
	19 0-1-1-0-20			
6	21 0-1-1-0-22			
	23 0-1-1-0-24			

Order #
 20KD-58 includes NP 55C-3B33



APPLICATION SPECIFIC SWITCHES

SERIES 20 ROTARY SWITCHES

ELECTROSWITCH		SERIES 20 INSTRUMENT & CONTROL SWITCHES		SWITCH NUMBER _____ ENGRAVING CODE _____ REV _____																			
<input type="checkbox"/> 20 K STANDARD <input type="checkbox"/> 20 M PLUG IN MODULE <input type="checkbox"/> 20 P LIGHTED FRONT OF PANEL MOUNT		Panel Thickness _____ Depth behind panel _____ SPECIAL FEATURES		MOUNTING & LIGHT PACKAGES <input type="checkbox"/> 2-HOLE PANEL MOUNT NO LIGHT PACKAGE <input type="checkbox"/> 4-HOLE PANEL MOUNT 2 LIGHTS <input type="checkbox"/> 4-HOLE PANEL MOUNT 3 LIGHTS LAMPS ARE 24-28 VOLTS <input type="checkbox"/> DROPPING RESISTORS FOR 125VDC SUPPLY <input type="checkbox"/> NO DROPPING RESISTORS LAMP COLORS 1 _____ 2 _____ 3 _____																			
HANDLES <input type="checkbox"/> Knurled <input type="checkbox"/> Oval <input type="checkbox"/> Pistol-Grip <input type="checkbox"/> None <input type="checkbox"/> Removable in Pos _____		ACTIONS <input type="checkbox"/> Maintained <input type="checkbox"/> Spring return to Vertical (0°) OTHER FEATURES <input type="checkbox"/> Slip contacts <input type="checkbox"/> Pull to lock		HANDLE POSITIONS <input type="checkbox"/> 45° <input type="checkbox"/> 90° <input type="checkbox"/> 30° <input type="checkbox"/> TARGET																			
X-CHART FOR SERIES 20 SWITCHES																							
<table border="1" style="width:100%; border-collapse: collapse;"> <tr> <th colspan="2" style="text-align: left;">TITLE ENGRAVING</th> <th colspan="2" style="text-align: left;">Use for all except slip contacts</th> <th colspan="2" style="text-align: left;">Use for Switches with slip contacts</th> </tr> <tr> <th colspan="2" style="text-align: left;">POSITION ENGRAVING</th> <th colspan="4" style="text-align: left;">FOR 20K & 20P ONLY</th> </tr> <tr> <td colspan="2"></td> <td></td><td></td><td></td><td></td> </tr> </table>						TITLE ENGRAVING		Use for all except slip contacts		Use for Switches with slip contacts		POSITION ENGRAVING		FOR 20K & 20P ONLY									
TITLE ENGRAVING		Use for all except slip contacts		Use for Switches with slip contacts																			
POSITION ENGRAVING		FOR 20K & 20P ONLY																					
DECK	CONTACTS HANDLE END	POSITIONS								3 from													
		1	2	3	4	5	6	7	8	1	2	3	4										
1	10-1-1-02 30-1-1-04																						
2	50-1-1-06 70-1-1-08																						
3	90-1-1-10 110-1-1-12																						
4	130-1-1-14 150-1-1-16																						
5	170-1-1-18 190-1-1-20																						
6	210-1-1-22 230-1-1-24																						
7	250-1-1-26 270-1-1-28																						
8	290-1-1-30 310-1-1-32																						
9	330-1-1-34 350-1-1-36																						
10	370-1-1-38 390-1-1-40																						
11	410-1-1-42 430-1-1-44																						
12	450-1-1-46 470-1-1-48																						

	JUMPERS FOR SERIES 20K & 20P				JUMPERS FOR SERIES 20M					------------------------------	----	----	----	------------------------	----	----	----		4	3	1	2	4	3	1	2		8	7	5	6	8	7	5	6		12	11	9	10	12	11	9	10		16	15	13	14	16	15	13	14		20	19	17	18	20	19	17	18		24	23	21	22	24	23	21	22		28	27	25	26	28	27	25	26		32	31	29	30	32	31	29	30		36	35	33	34	36	35	33	34		40	39	37	38	40	39	37	38		44	43	41	42	44	43	41	42		48	47	45	46	48	47	45	46						
LAMP WIRING (20M)																																																																																																																																			
SLIP CONTACTS WILL BE GROUPED AT REAR OF SWITCH. A MAXIMUM OF 4 SLIP CONTACTS ARE AVAILABLE.																																																																																																																																			
SHOW JUMPERS TO BE SUPPLIED																																																																																																																																			
DOCUMENT CONTROL Quality Assurance ANSI/ASME NQA-1 Qualification ESC-STD-1000 DRAWING MASTER Switch-20K, 20P, 20M																																																																																																																																			
MADE BY:	DATE:	COMPANY		DWG NO.																																																																																																																															
APPR BY:	DATE:			SHEET	OF																																																																																																																														



SERIES 101 FOUR HOLE MOUNT SNAP-ACTION INSTRUMENT AND CONTROL SWITCHES

Features

- Double-Wiping Contacts for Low Resistance Even Under Extreme Shock and Vibration
- Fast Switching Speed Independent of Operator Action - Approximately 10 Milliseconds
- Standard Four Hole Mount – Single Hole Mount Available
- NEMA Class A (105°C) Insulating Materials
- Excellent for DC as well as AC Switching
- Making and Breaking of Contacts Performed Inside Enclosed Decks

Electrical Specifications

Continuous Ratings

- 20A/600VAC

Interrupt Ratings

- 15A/120VAC
- 10A/240VAC
- 7.5A/600VAC, (Circuit 1, 2, 3, 4)
- 10A/125VDC
- 5A/250VDC
- 1A/600 VAC, (Circuit 6, 7)
- Overload Current (50 operations): 90A/600VAC Restrictive
- Dielectric Breakdown: 2200V rms minimum
- Insulation Resistance: 100 Megohms minimum
- Contacts Resistance: 30 Milliohms max. (10 Milliohms Average Before Life)
- For Higher Rated Snap Action Switches Consult Factory

Mechanical Specifications

Poles	Circuit 1 = 12 MAX; Circuit 2, 3 & 4 = 8 MAX; Circuit 6 & 7 = 11 MAX
Positions	2, 3, or 4
Contacts	Break-Before-Make (Non-Shorting); Make-Before-Break (Shorting)
Action	Positive Snap Action - 90° Indexing
Movement	Unlimited Continuous Rotation in Both Directions or Factory Limited to 2 or 3 Positions
Mounting	Panel Mount, 4 Tapped Mounting Holes
Panel Thickness	3/16" Standard
Rotor Contacts	Phosphor-bronze, Double Grip
Stationary Contacts	Copper, Integral with Screw Type Terminals
Construction	Contacts Enclosed in Molded-phenolic Disks

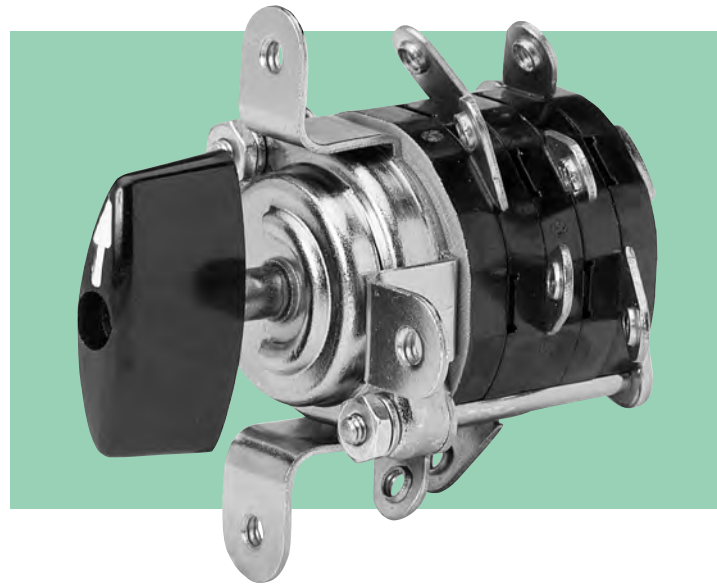

ORDERING INFORMATION - (For generic switches fill out matrix below. For application specific switches see page 36.)

Model No. 101	<input type="checkbox"/>	<input type="checkbox"/>	<input type="checkbox"/>	<input type="checkbox"/>	<input type="checkbox"/>
Series (See Page 36)					Indexing (See Page 36) Blank = Standard A = Offset 45°
Circuit					
1 = Circuit 1	Number of Poles		Handle		No. of Positions (See Page 36) Blank = Unlimited
2 = Circuit 2	01 = 1	07 = 7	A = Oval Flush		2 = 2
3 = Circuit 3	02 = 2	08 = 8	B = Oval		3 = 3
4 = Circuit 4	03 = 3	09 = 9	C = Round Knurled		
6 = Circuit 6	04 = 4	10 = 10	D = Pistol-Grip		
7 = Circuit 7	05 = 5	11 = 11			
	06 = 6	12 = 12			

Note 1: Single Hole mount available for direct toggle switch replacement.
 Note 2: Higher rated versions available for applications up to 200A/600VAC.
 Note 3: For limits on the # of poles available in each circuit, see depth behind panel chart.

Approvals

- UL: File No. E18174
- CSA

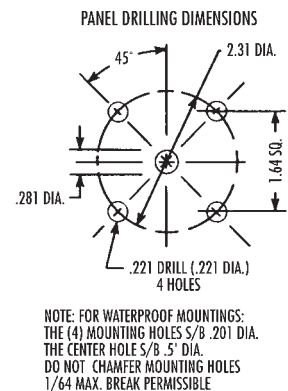
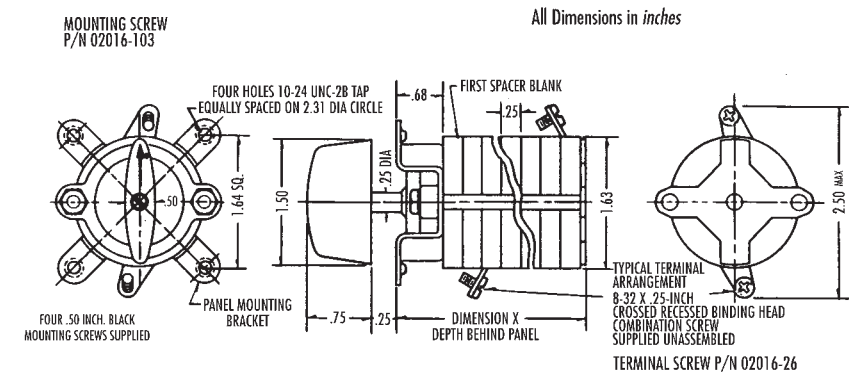

No. of Poles	Depth Behind Panels (in.)		
	Circuit 1	Circuit 6 & 7	Circuit 2, 3, 4
1	1.28	1.28	1.53
2	1.53	1.53	2.03
3	1.78	1.78	2.53
4	2.03	2.03	3.03
5	2.28	2.28	3.53
6	2.53	2.53	4.03
7	2.78	3.00	4.65
8	3.03	3.16	5.16
9	3.41	3.41	-
10	3.66	3.66	-
11	3.91	3.91	-
12	4.16	-	-



SERIES 101 SINGLE HOLE MOUNT SNAP-ACTION INSTRUMENT AND CONTROL SWITCHES

Features

- Double-Wiping Contacts for Low Resistance Even Under Extreme Shock and Vibration
- Fast Switching Speed Independent of Operator Action - Approximately 10 Milliseconds
- Single Hole Mount
- NEMA Class A (105°C) Insulating Materials
- Excellent for DC as well as AC Switching
- Making and Breaking of Contacts Performed Inside Enclosed Decks

Electrical Specifications

Continuous Ratings

- 20A/600VAC

Interrupt Ratings

- 15A/120VAC
- 10A/240VAC
- 7.5A/600VAC, (Circuit 1,2,3,4)
- 10A/125VDC
- 5A/250VDC
- 1A/600 VAC, (Circuit 6, 7)
- Overload Current (50 operations): 90A/600VAC Resistive
- Dielectric Breakdown: 2200V rms minimum
- Insulation Resistance: 100 Megohms minimum
- Contacts Resistance: 30 Milliohms max. (10 Milliohms Average Before Life)

Mechanical Specifications

Poles	Circuit 1 = 6 MAX; Circuit 2, 3 & 4 = 3 MAX; Circuit 6 & 7=6 MAX
Positions	2, 3, or 4
Contacts	Break-Before-Make (Non-Shorting); Make-Before-Break (Shorting)
Action Movement	Positive Snap Action - 90° Indexing Unlimited Continuous Rotation in Both Directions or Factory Limited to 2 or 3 Positions
Mounting	Panel Mount, 4 Tapped Mounting Holes
Panel Thickness	3/16" Standard
Rotor Contacts	Phosphor-bronze, Double Grip
Stationary Contacts	Copper, Integral with Screw Type Terminals
Construction	Contacts Enclosed in Molded-phenolic Disks

Approvals

- UL: File No. E18174
- CSA: File No. LR20743

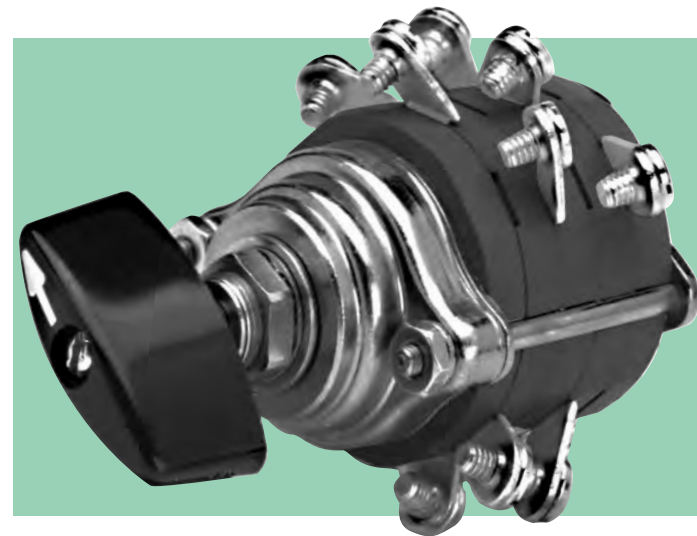

ORDERING INFORMATION - Specials

Model No. 102	<input type="checkbox"/>	<input type="checkbox"/>	<input type="checkbox"/>	<input type="checkbox"/>
Series	To be assigned at factory			
Circuit See Pg. 36	Number of Poles*			
1 = Circuit 1	01 = 1			
2 = Circuit 2	02 = 2			
3 = Circuit 3	03 = 3			
4 = Circuit 4	04 = 4			
6 = Circuit 6	05 = 5			
7 = Circuit 7	06 = 6			

* Circuit 1: 6 Poles Max., Circuits 2, 3, & 4: 3 Poles Max., Circuits 6 & 7: 6 Poles Max. Beyond 6 poles consult factory.
Note 1: For limits on the # of poles available in each circuit, see depth behind panel chart.

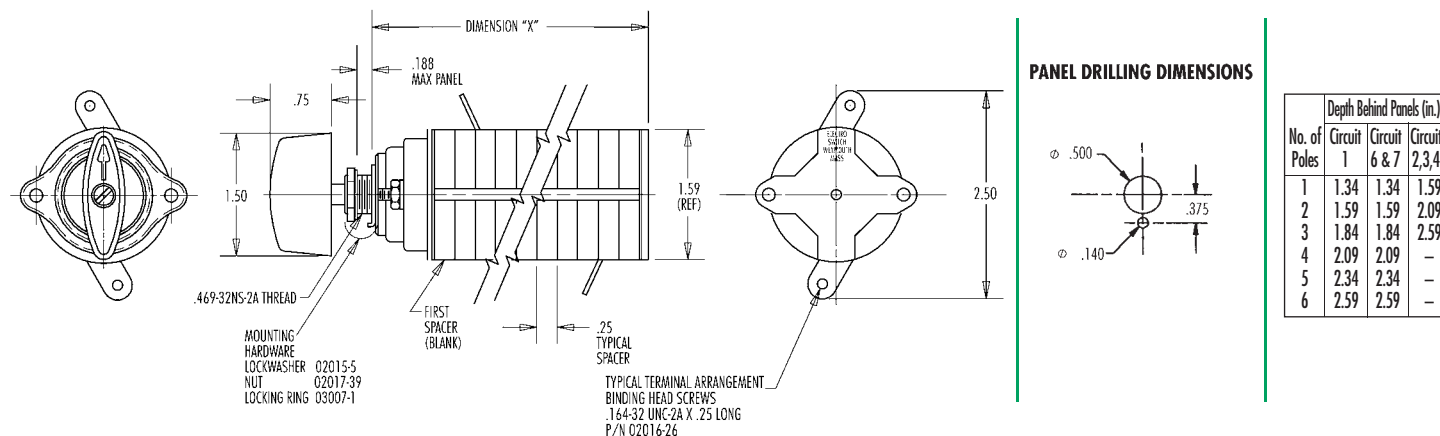



SERIES 102 AUXILIARY MODIFIED SNAP-ACTION SWITCHES

Features

- Double-Wiping Contacts for Low Resistance Even Under Extreme Shock and Vibration
- Two Hole Mount
- NEMA Class A (105°C) Insulating Materials
- Excellent for DC as well as AC Switching
- Making and Breaking of Contacts Performed Inside Enclosed Decks

Electrical Specifications

Continuous Ratings

- 20A/600VAC

Interrupt Ratings

- 15A/120VAC
- 10A/240VAC
- 7.5A/600VAC, (Circuit 1, 2, 3, 4)
- 10A/125VDC
- 5A/250VDC
- 1A/600 VAC, (Circuit 6, 7)
- Overload Current (50 operations): 90A/600VAC Resistive
- Dielectric Breakdown: 2200V rms minimum
- Insulation Resistance: 100 Megohms minimum
- Contacts Resistance: 30 Milliohms max. (10 Milliohms Average Before Life)

Mechanical Specifications

Poles	Circuit 1 = 24 MAX
Contacts	Break-Before-Make (Non-Shorting); Make-Before-Break (Shorting)
Action	90° Indexing
Movement	Unlimited Continuous Rotation in Both Directions
Mounting	Panel Mount, 2 Holes
Rotor Contacts	Phosphor-bronze, Double Grip
Stationary Contacts	Copper, Integral with Screw Type Terminals
Construction	Contacts Enclosed in Molded-phenolic Disks

Approvals

- UL: File No. E18174
- CSA: File No. LR20743

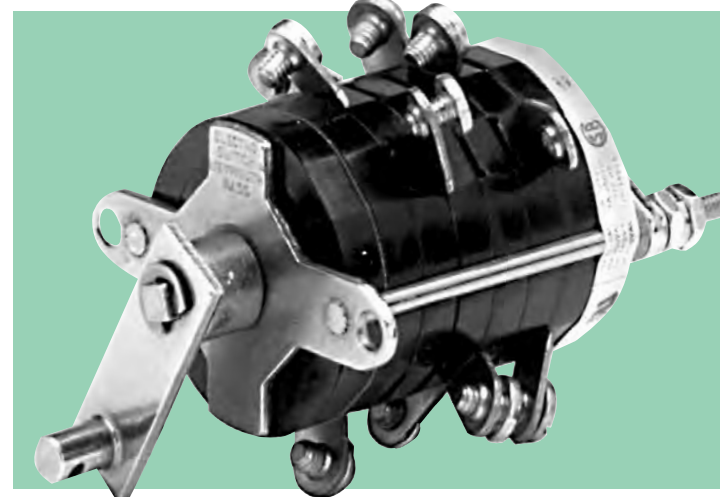

ORDERING INFORMATION

Consult Factory for Complete Details and Ordering Information

TYPICAL CIRCUITS

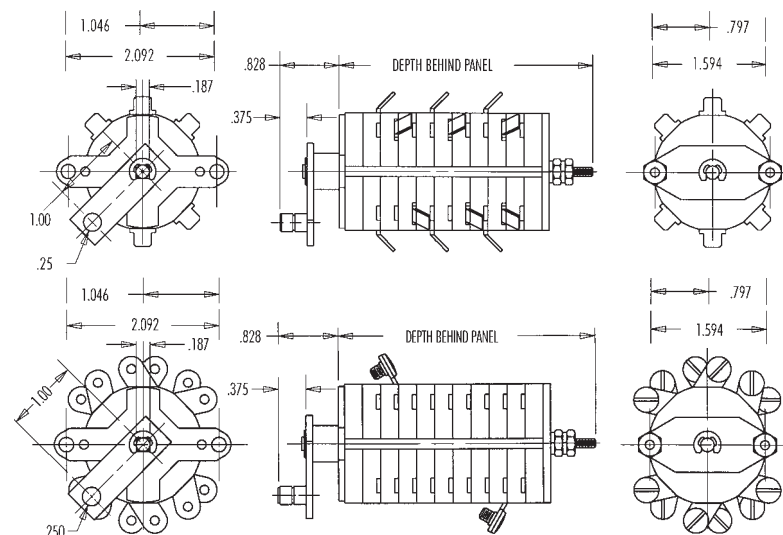
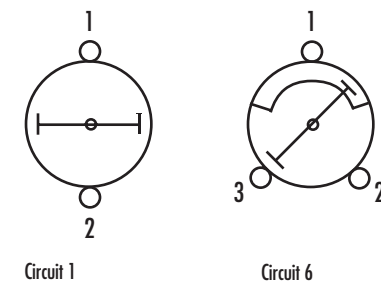

PANEL DRILLING DIMENSIONS

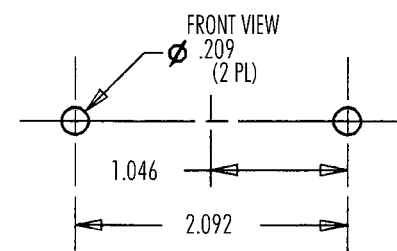



SERIES 101 SWITCHES

SNAP-ACTION INSTRUMENT AND CONTROL SWITCHES

CONTACT DIAGRAMS

CIRCUIT NO. 1

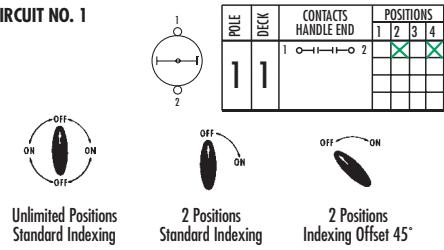

CIRCUIT NO. 2

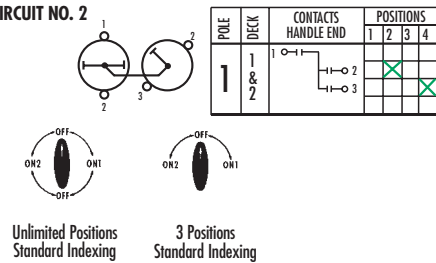

CIRCUIT NO. 3

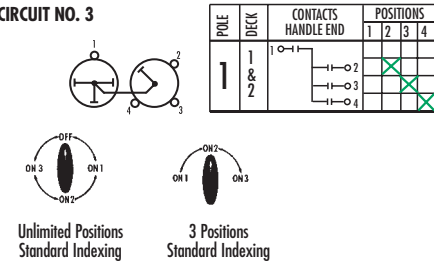

CIRCUIT NO. 4

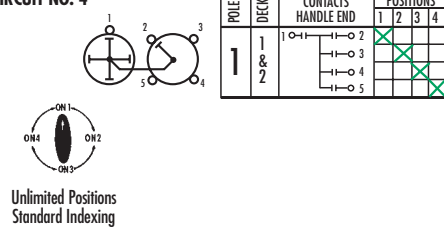

CIRCUIT NO. 6

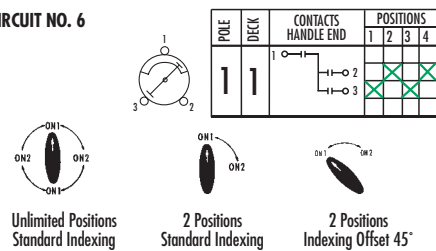

CIRCUIT NO. 7

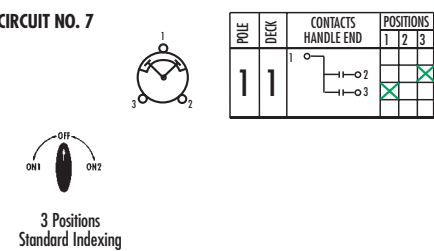

APPLICATION SPECIFIC SWITCHES

REVERSING SWITCH Three Phase

Order #101703A-3
Handle: Oval
Jumpers not supplied
Break-before-make contacts

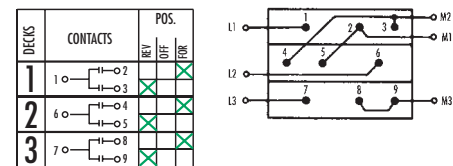
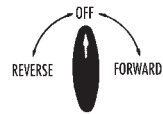

WYE DELTA Changeover Switch

Order #101603A-2
For motor speed control
Handle: Oval
Jumpers not supplied
Break-before-make contacts

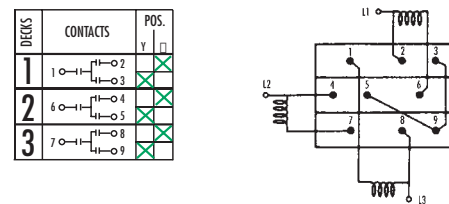

SHIP-TO-SHORE Changeover Switch

Order #101602A-2A
Handle: Oval
Jumpers not supplied
Break-before-make contacts

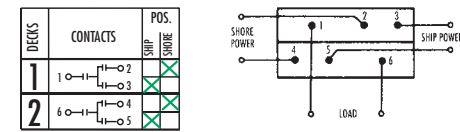

VOLTMETER Transfer Switch

Order #10104C
3-phase, phase-to-phase
Handle: Round, Knurled
Nameplates and jumpers are supplied
Break-before-make contacts

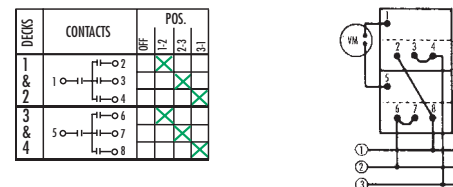
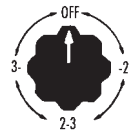

AMMETER Transfer Switch

Order #10110C
3-phase, 3 current transformers
Handle: Round, Knurled
Nameplates and jumpers are supplied
Make-before-break contacts

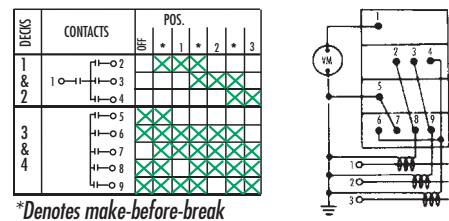
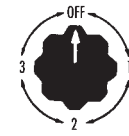

AMMETER-VOLTMETER Transfer Switch

Order #10115C
3-phase, phase-to-phase
3 current transformers
Handle: Round, Knurled
Nameplates and jumpers are supplied
Make-before-break (shorting) contacts

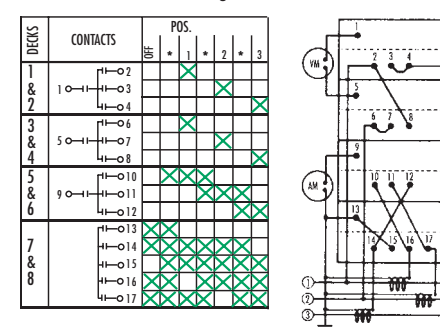
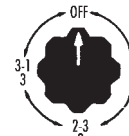



TYPE W-2 INSTRUMENT AND CONTROL SWITCHES

Features

- Lateral Push/Pull Contacts
- Up to 12 Positions
- Compact Size
- Roller-Wipe Spring Actuated Contacting
- Momentary, Maintained and Combination Contacting Designs
- Virtually Unlimited Switching Combinations
- Double Break Contacts per Stage
- Large Number of Contacts per Unit Available
- Slip and Lateral Contacts Available
- Options for Up To Three Key Interlocks

Instrument Switch Special Features

- Maintained Contact Type Used for Performing Various Circuit Combinations
- Pull to Lock for Safety Lockout

Control Switch Special Features

- Mechanical Red/Green Target
- Spring Return to Normal (Vertical) Position
- Positive Detent Positioning Roller Action Mechanism
- Slip and Lateral Contacts Available

Electrical Specifications

Continuous Ratings

- 20A/600 Volts

Interrupt Rating

- 30A/120VAC
- 20A/240VAC
- 8A/600VAC
- 5A/125VDC
- 1A/250VDC

Pull contacts are rated for 10 amps continuous

Mechanical Specifications

Decks	1 to 8
Poles	1 to 48
Positions	2 to 12
Contacts	Break-Before-Make (Non-Shorting); Make-Before-Break (Shorting)
Action	30° Positive Indexing
Mounting	Panel Mount
Panel Thickness	1/4" Max. Standard
Rotor Contacts	Silver Plated Phosphor-bronze
Stationary Contacts	Silver Plated, Bronze with Stud
Construction	Contacts Enclosed in a Glass Polyester Frame

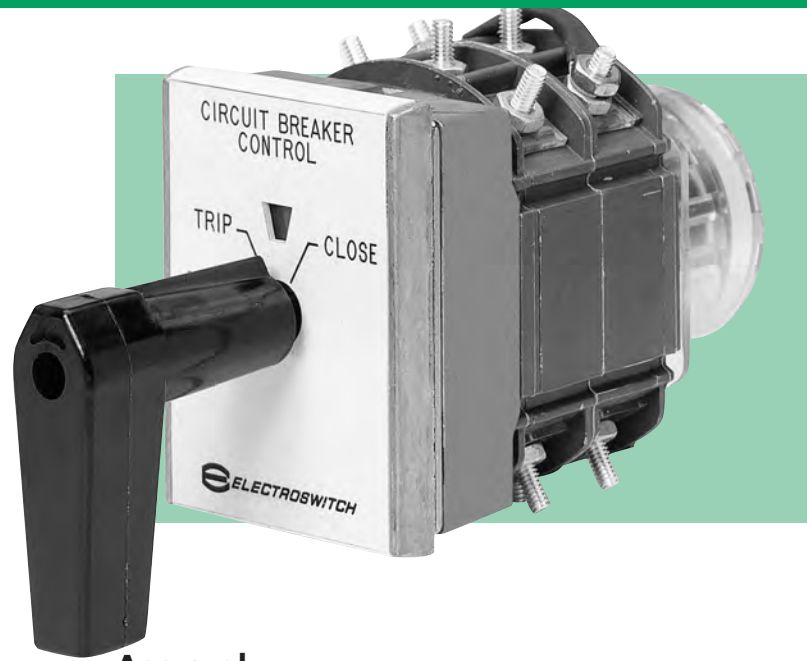

Approval

- UL E129204
- CSA Certified

Operation

The Type W-2 Switch is a rotary roller action switch. Rotation of the shaft causes the spring loaded rotor rollers to move from one set of stationary contacts to another. The number of roller contacts can vary from 1 to 6. On standard potential contacts, an insulated wheel is used on both ends of the roller contact that rolls inside the stator frame.

Contact Terminals

Method of identifying contact terminal: Lettered Bands, Numbered Rows

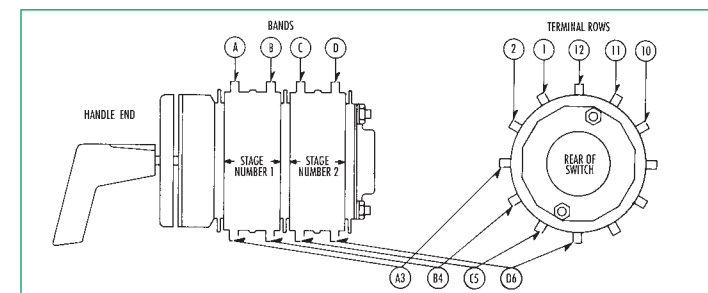

Ordering Information

See pages 39 - 41

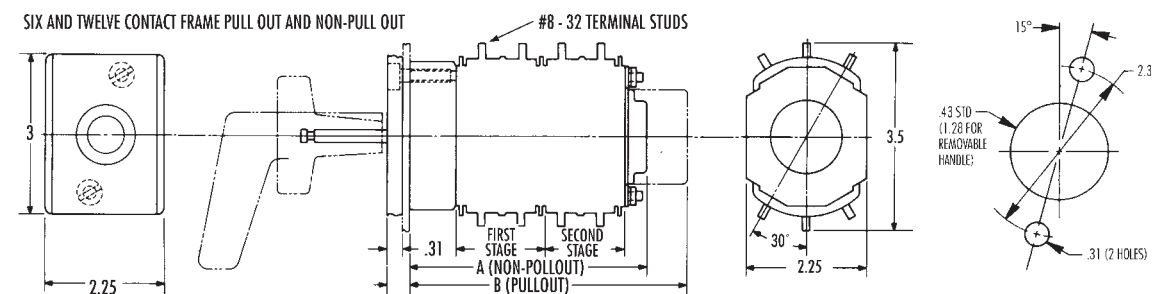

Depth Behind Panel (in)		
No. of Stages	Dim. A	Dim. B
1	3.32	3.81
2	4.82	5.31
3	6.32	6.81
4	7.82	8.31
5	9.32	9.81
6	10.82	11.31
7	12.32	12.81
8	13.82	14.31



APPLICATION SPECIFIC SWITCHES

TYPE W-2 INSTRUMENT AND CONTROL SWITCHES

AMMETER – Switches

3-phase-2 CT's
 Handle: Round
 Contacts: Maintained
 Stages: 2, Six Contact Frame
 Mounting: 1/8-1/4
 Target: No
 Basic Switch #: 505A601G01

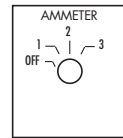

CONTACT	POSITION	0	1	2	3
A11-B11			X		
A12-B12			X		
A1-B1			X		
A5-B5			X		
A6-B6			X		
A7-B7			X		
C11-D11			X		
C12-D12			X		
C1-D1			X		
C5-B5			X		
C6-B6			X		
C7-D7			X		

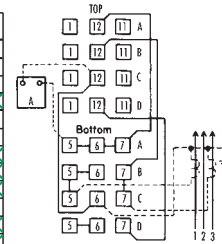

Order #
505A701G02

3-phase-3 CT's
 Handle: Round
 Contacts: Maintained
 Stages: 2, Six Contact Frame
 Mounting: 1/8-1/4
 Target: No
 Basic Switch #: 505A601G01

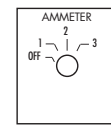

CONTACT	POSITION	0	1	2	3
A11-B11			X		
A12-B12			X		
A1-B1			X		
A5-B5			X		
A6-B6			X		
A7-B7			X		
C11-D11			X		
C12-D12			X		
C1-D1			X		
C5-B5			X		
C6-B6			X		
C7-D7			X		

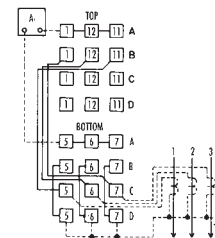

Shown as "End of Circuit"

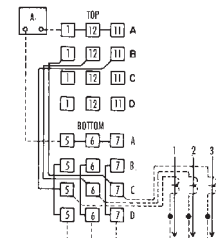

Shown as "Middle of Circuit"

Order #
505A701G01

VOLTMETER–Switch

3-phase-3 Wire
 Handle: Round
 Contacts: Maintained
 Stages: 1, Six Contact Frame
 Mounting: 1/8-1/4
 Target: No

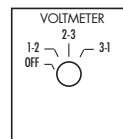

CONTACT	POSITION	0	1-2	2-3	3-1
A11-B11			X		
A12-B12			X		
A1-B1			X		
A5-B5			X		
A6-B6			X		
A7-B7			X		

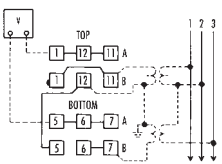

Tabulation of
Switch as Jumpered

A1-B4	X	X
A1-B12	X	X
A5-B5	X	X
A5-B7	X	X

Order #
505A702G04

CIRCUIT BREAKER–Control Switches

Handle: Pistol-Grip or Oval
 Contacts: Momentary
 Stages: 1, Six Contact Frame
 Mounting: 1/8-1/4
 Target: Yes
 Basic Switch #: 505A613G01

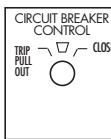

CONTACT	POSITION	P	T	O	C
A11-B11		X			
A12-B12		X			
A1-B1		X			
A5-B5		X			
A6-B6		X			
A7-B7		X			

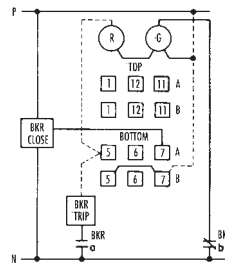

Order #
Pistol-Grip: 505A713G01
Oval: 505A713G03

Handle: Pistol-Grip or Oval
 Contacts: Momentary
 Stages: 1, Six Contact Frame
 Mounting: 1/8-1/4
 Target: Yes
 Basic Switch #: 505A614G01

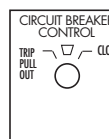

CONTACT	POSITION	P	T	OFF	AFT	OFF	C
A11-B11		X					
A12-B12		X					
A1-B1		X					
A5-A6		X					
A6-A7		X					
B5-B6		X					
B6-B7		X					

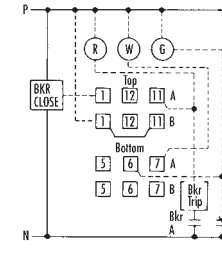

Order #
Pistol-Grip: 505A714G01
Oval: 505A714G02

CIRCUIT BREAKER–Control Switch

Handle: Pistol-Grip
 Contacts: Momentary
 Stages: 1, Six Contact Frame
 Mounting: 1/8-1/4
 Target: Yes
 Faceplate: #62F-2C30G

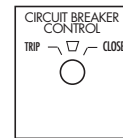

CONTACT	POSITION	T	O	C
A11-B11		X		
A12-B12		X		
A1-B1		X		
A5-B5		X		
A6-B6		X		
A7-B7		X		

Order #
508A207G02

OFF/ON–Instrument Switch

Handle: Oval, Pistol-Grip, or Round
 Contacts: Maintained
 Stages: 1, Six Contact Frame
 Mounting: 1/8-1/4
 Target: No

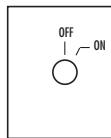

CONTACT	POS.	OFF	ON
A11-B11		X	
A12-B12		X	
A1-B1		X	
A5-B5		X	
A6-B6		X	
A7-B7		X	



Order #
Oval: 505A706G01
Pistol-Grip: 505A706G02
Round: 505A706G03

OFF/ON–Control Switch

Handle: Oval, Pistol-Grip, or Round
 Contacts: Momentary
 Stages: 1, Six Contact Frame
 Mounting: 1/8-1/4
 Target: No

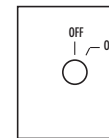

CONTACT	POS.	OFF	ON
A11-B11		X	
A12-B12		X	
A1-B1		X	
A5-B5		X	
A6-B6		X	
A7-B7		X	



Order #
Oval: 505A723G01
Pistol-Grip: 505A723G02
Round: 505A723G03



APPLICATION SPECIFIC SWITCHES

TYPE W-2 INSTRUMENT AND CONTROL SWITCHES

BASIC SWITCHES

Basic switches do not include handle, nameplate, or external jumpers; these items may be ordered separately. For handles see page 80, nameplates see page 81 and external jumpers see page 83. For complete switch style including handle, nameplate and jumpers, contact the factory.

Momentary Switches

Handle: Fixed **Order #505A623G01**
 Handle: Removable **Order #663A177G01**
 Target: No

Maintained Switches

Handle: Fixed **Order #505A606G01**
 Handle: Removable **Order #505A647G01**
 Target: No

CONTACT	POSITION	
	12	1
A11-B11		X
A12-B12	X	
A1-B1		X
A5-B5		X
A6-B6	X	
A7-B7		X

Momentary Switches

Handle: Fixed **Order #505A624G01**
 Target: No

Maintained Switches

Handle: Fixed **Order #505A621G01**
 Handle: Removable **Order #505A672G01**
 Target: No

CONTACT	POS.	
	12	1
A11-B11		X
A12-B12	X	
A1-B1		X
A5-B5		X
A6-B6	X	
A7-B7		X
C11-D11	X	
C12-D12		X
C1-D1	X	
C5-D5	X	
C6-D6		X
C7-D7	X	

Momentary Switches

Handle: Fixed **Order #505A684G01**
 Target: No

Maintained Switches

Handle: Fixed **Order #505A628G01**
 Handle: Removable **Order #505A685G01**
 Target: No

CONTACT	POS.	
	12	1
A11-B11		X
A12-B12	X	
A1-B1		X
A5-B5		X
A6-B6	X	
A7-B7		X
C11-D11	X	
C12-D12		X
C1-D1	X	
C5-D5	X	
C6-D6		X
C7-D7	X	
E11-F11	X	
E12-F12		X
E1-F1	X	
E5-F5	X	
E6-F6		X
E7-F7	X	

Momentary Switches

Handle: Fixed **Order # 505A603G01**
 W/Target: **Order # 508A107G01**
 Handle: Removable **Order # 663A195G01**
 Target: No

Maintained Switches

Handle: Fixed **Order # 505A602G01**
 Handle: Removable **Order # 508A108G01**
 Target: No

CONTACT	POSITION		
	11	12	1
A11-B11	X		
A12-B12		X	
A1-B1			X
A5-B5			X
A6-B6	X		
A7-B7			X

Momentary Switches

Handle: Fixed **Order # 505A627G01**
 W/Target: **Order # 508A145G01**
 Handle: Fixed **Order # 508A145G01**
 Target: Yes

Maintained Switches

Handle: Fixed **Order # 505A626G01**
 Target: No
 Handle: Removable **Order # 508A146G01**
 Target: No

CONTACT	POSITION		
	11	12	1
A11-B11	X		
A12-B12		X	
A-B1			X
A5-B5			X
A6-B6	X		
A7-B7			X
C11-D11	X		
C12-D12		X	
C1-D1	X		
C5-D5	X		
C6-D6		X	
C7-D7	X		
E11-F11	X		
E12-F12		X	
E1-F1	X		
E5-F5	X		
E6-F6		X	
E7-F7	X		

Momentary Switches

Order # 505A615G01
 W/Target: **Order # 508A118G01**

Maintained Switches

Order # 505A612G01
 W/ Removable Handle: **Order # 508A119G01**

CONTACT	POSITION		
	11	12	1
A11-B11	X		
A12-B12		X	
A1-B1			X
A5-B5			X
A6-B6	X		
A7-B7			X
C11-D11	X		
C12-D12		X	
C1-D1	X		
C5-D5	X		
C6-D6		X	
C7-D7	X		



TYPE W INSTRUMENT AND CONTROL SWITCHES

In 1988, Electroswitch acquired the Type W Switches and Relays from Westinghouse Corporation for the purpose of maintaining a high level of support and assistance to existing customers in the utility industry. Since that time, many changes have been made in switch technology and these models have been replaced. However, Electroswitch continues to offer the Type W Switches for customers needing replacements into existing systems that would require panel rework.

Features

- Rugged Time Tested Design
- Available with Maintained or Momentary Contacts
- Silver Surfaced Contacts for Low Contact Resistance
- Self-Aligning Stationary Contacts
- Contact Wiping Action Ensures Clean, Low-Resistance Contact
- Each Stud Numbered for Terminal Identification
- Protective Side Plated Slide Out for Easy Contact Inspection
- Slip and Lateral Contacts Available
- Supplied With Standard Black Nameplate - Engraving Optional

Control Switch Special Features

- Mechanical Red/Green Target
- Spring Return to Normal (Vertical) Position

Electrical Specifications

Interrupt Ratings

- 50A/120VAC
- 25A/240VAC
- 5A/600VAC
- 8A/125VDC

Mechanical Specifications

Decks	2 to 10
Poles	2 to 10
Positions	2 to 12
Contacts	Break-Before-Make (Non-Shorting) Make-Before-Break (Shorting)
Mounting	Panel Mount
Panel Thickness	1/4" Max. with Modern Handle, 2" Max. with Heavy Duty Handle
Rotor Contacts	Silver Plated Brass
Stationary Contacts	Silver Plated Silicone Bronze, Stud Type Terminals

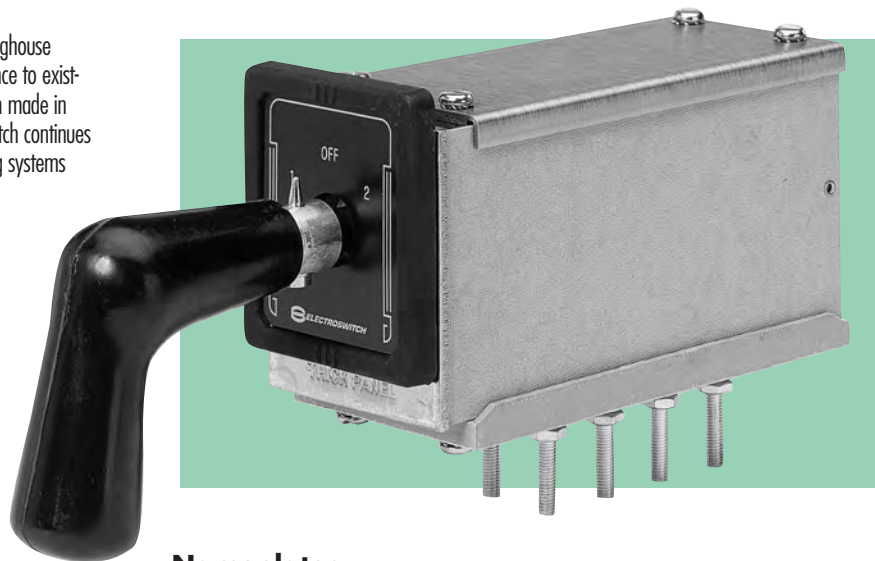

Nameplates

Type W Switches are supplied with a standard black nameplate that can be engraved to your requirements. Circuit Breaker Control Switches have a cutout in the nameplate for a red and green target indicator to show the last manual operation of the switch. Special engravings should be indicated clearly at the time of order.

Ordering Information – Please consult factory

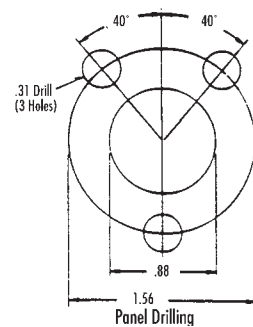
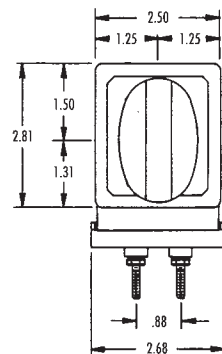
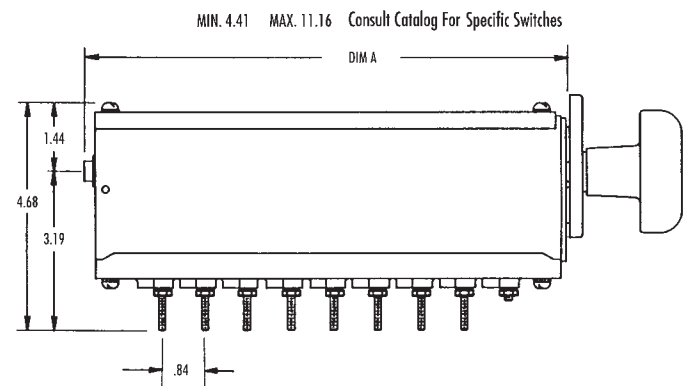



LOCK-OUT RELAYS

By definition the Lock-Out Relay plays a pivotal role in the most crucial utility applications. In an emergency, Lock-Out Relay performance can spell the difference between a routine outage and the destruction of expensive equipment. Protect your system and safeguard your personnel with the industry standard for safety and reliability. There's NEVER A DOUBT with the Electroswitch family of Lock-Out Relays.

Note: The Series 24 LOR Class 1E utility products comply with the following Nuclear Standards: ANSI/IEEE C37.90, ANSI/IEEE C37.90.01, ANSI/IEEE C37.98, ANSI/IEEE C37.105, ANSI/IEEE 323, ANSI/IEEE 344, ANSI/ASME NQA -1.

The Series 24 Lock-Out Relays

- HIGH QUALITY**
 - Designed and manufactured to the highest standards in the industry
 - Qualified to UL, CSA
- VERSATILITY**
 - 9 Different trip coils to choose from
 - Up to 20 N/O and 20 N/C contacts in one standard LOR.
 - Available with electric reset capability
 - Available with built-in coil monitoring and fault signal detection/indication
- HIGH SPEED**
 - Transition times of less than 8mSec (less than 1/2 cycle) are standard
- SAFETY**
 - Series 24 - 1E Nuclear Qualified, UL, CSA
- AVAILABILITY**
 - Virtually all Series 24 Manual Reset LORs are available from stock for immediate delivery
 - The most popular Electric Reset LOR/ERs are also in stock
- SERVICE**
 - The Electroswitch team of Customer Service and Applications Professionals stand behind every Electroswitch product. Let us put over 50 years of know-how to work for you!

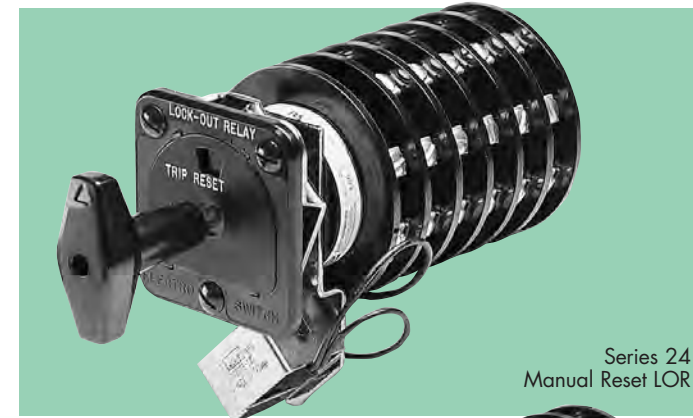

Series 24
Manual Reset LOR

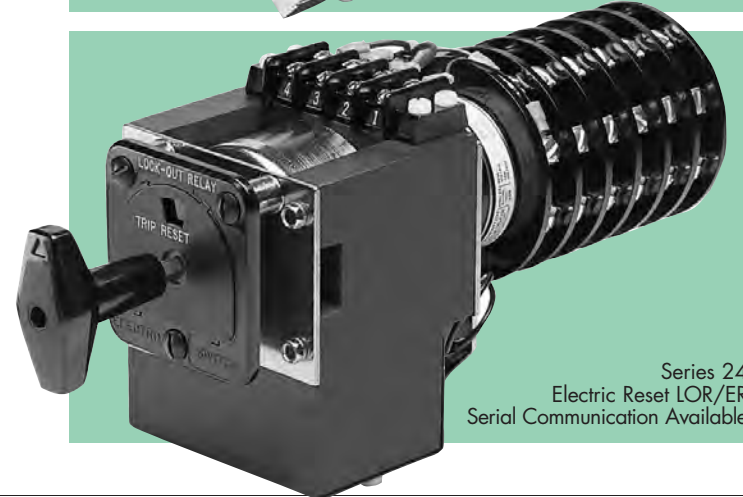

Series 24
Electric Reset LOR/ER
Serial Communication Available

Type WL-2 and WL Lock-Out Relays

Since 1988 Electroswitch has been the source for the Type WL-2 and WL Lock-Out Relays. These rugged, dependable devices, designed and originally manufactured by Westinghouse, have stood the test of time in utility and industrial applications worldwide. Now they are

available for either new applications or replacement, backed by the industry leading Electroswitch commitment to Quality and Service.



Type WL-2
Lock-Out Relay

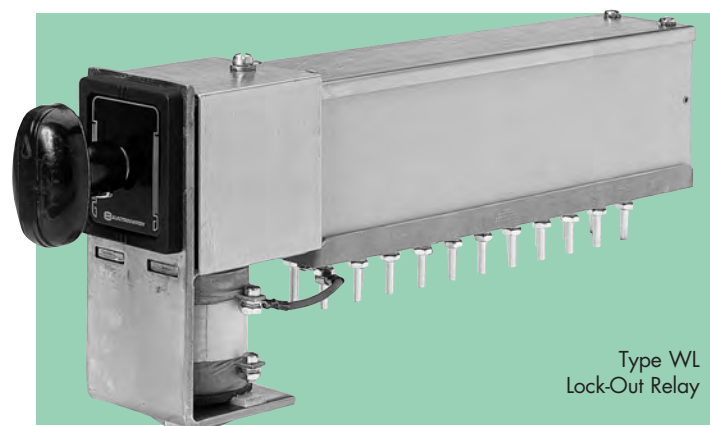

Type WL
Lock-Out Relay



SERIES 24 LOR

With Lighted Target Nameplate

Lighted Target Nameplates Save Panel Space and Reduce Costs

The Electroswitch Series 24 Lock-Out Relay, the Utility Industry Standard for Quality and Reliability, is now available with:

- Integral Coil Monitoring with LED Display and SCADA Feedback.
- LED Indication of Existing Fault Signal.

The Lock-Out Relay fills one of the most critical needs in the utility industry protection scheme. A fast, reliable Lock-Out Relay can mean the difference between a routine fault clearance and a disastrous loss of service, maintenance time and expensive equipment damage.

To assure that this crucial device is functioning and ready to operate, many utilities install pilot lamps on the panel to monitor the integrity of the LOR coil. This can involve expensive inter-wiring and use precious panel space. Because of this, Electroswitch has integrated these monitoring functions and more on a new electronic nameplate for the LOR.

Features

- Cost-effective Elimination of Additional Wiring and Lamps Needed to Perform this Function. Just Attach the Pre-wired Leads per the Enclosed Instructions.
- Save Valuable Panel Space. The Entire Package Fits in the Same Space as a Standard Mechanical LOR Nameplate.
- Both LOCAL (LED) and REMOTE (SCADA Signal) Indication is Provided; Reliable Protection for Unmanned Stations.
- Green LED indicates LOR Coil is Intact and Ready to Operate.
- Red LED Warns Against Resetting into an Existing Fault Signal and Possibly Damaging LOR Coils.
- Bright LEDs Visible Through 135°, > 11 Year Life (Typical).
- LEDs are Field Replaceable From the Front of Panel.
- LEDs are Available in Different Colors (Red, Amber, Green, Blue, and White).
- DC Unit Covers IEEE 24VDC and 48V/125V Ranges (38 to 140VDC).
- The Monitoring Package can be Implemented with Little or no Operator Training.
- This Product is Designed and Manufactured by Electroswitch to Work Flawlessly with the Ultra-reliable, High Speed Series 24 Lock-Out Relay.
- Optional Push-to-Test.

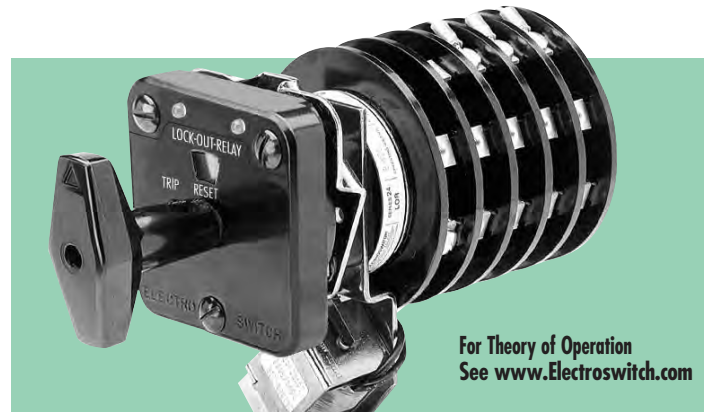

Benefits

- Provides Local and Remote (SCADA) Annunciation of an LOR Trip Coil Failure.
- Provides Clear Warning Against Closing into a Fault.
- Saves Panel Space.
- Reduces Purchase and Installation Cost.
- Easy to Use... No Special Operator Training.

How it Works

When the LOR is in the RESET position, one high visibility LED on the nameplate glows a continuous GREEN, giving local indication that coil continuity is intact and the Lock-Out Relay is ready to respond to a trip signal. Should the coil fail, the LED extinguishes and a built-in solid state contact closes, sending a warning signal to SCADA.

In the TRIP position, the red LED functions as a Trip Signal Monitor. As long as the Trip Signal is present on the LOR coil, the LED glows a continuous RED as a warning against resetting into a fault and possibly damaging the LOR coil. Other LED colors available (Amber, Blue and White).

The new design also retains the proven mechanical orange/black flag to indicate a trip. Contact your local Electroswitch Representative or call us directly for more details on how we can put the Electroswitch tradition of value and innovation to work for you.

Ordering Information

Part Numbers for the Series 24 LORs with Lighted Target Nameplate are fairly simple. Find the part number of the product you wish to order in the Electroswitch catalog, then simply add a two letter code after the second digit in its part number. The first letter of the two letter code will always be "P" indicating a Lighted Target Nameplate. The second letter of the code will change depending on the other options as follows.

A = One LED, 48/125VDC **B** = Two LEDs, 48/125VDC **K** = Two LEDs, 24VDC
Please Specify LED Colors. **Color Options** - Red, Green, Amber, Blue and White.

Example:

A Series 24 Manual Reset Lock-Out Relay with one deck and Trip Coil 'D' is part number **7801D**. The same Lock-Out Relay with a Lighted Target Nameplate, Two LEDs, and 48/125VDC LED voltage would become part number **78PB01D**.

Consult factory for 24VDC and 250VDC.

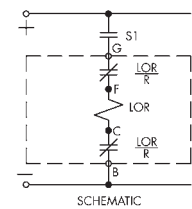
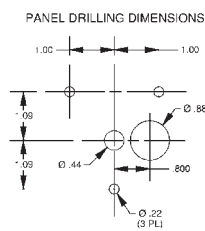
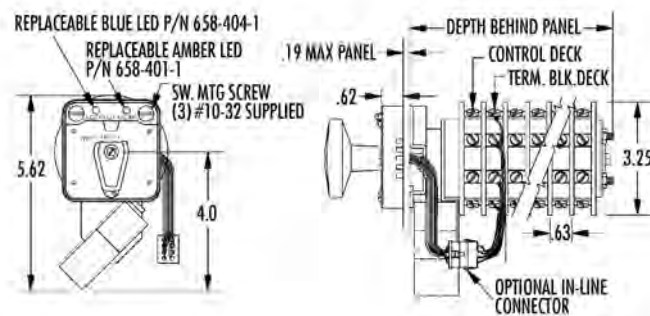
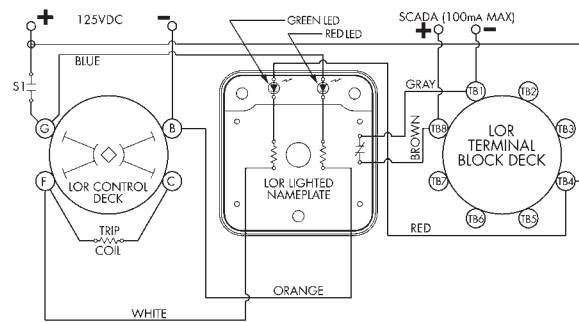

Depth Behind Panel

Decks	Depth
1	4.28
2	5.03
3	5.40
4	6.15
5	6.90
6	8.15
7	8.78
8	9.15
10	10.28



FEATURES

Typical Contact Deck Arrangement

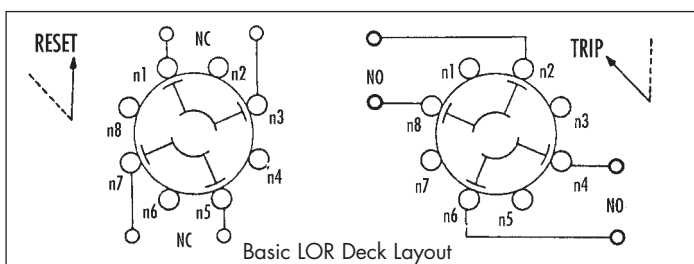

The blade and terminal configuration enables the use of multiple contacts in the same deck, and simple stacking procedures enable the fabrication of many independent contacts in one relay. Specifically, two N/O contacts and two N/C contacts are provided in each deck, and up to ten decks can be stacked, resulting in a relay with up to forty contacts (twenty N/O and twenty N/C). For good practice, however, it is suggested that polarized voltages should not be used on adjacent contacts. This is because of the remote possibility of flashover during transition between adjacent contacts -- especially at the higher DC ratings, or in highly inductive circuits. The illustration shows a single deck. For multideck units the second digit of the terminal number is the same as shown, but the first digit changes to denote the deck number. As an example, terminal 82 is in the eighth deck, directly under terminal 12 and is connected to terminal 88 in the trip position.

DECKS	CONTACTS	POS.	
		TRIP	RESET
1	11 ○— — —○ 13		✗
	12 ○— — —○ 18	✗	
	15 ○— — —○ 17		✗
	16 ○— — —○ 14	✗	
2	21 ○— — —○ 23		✗
	22 ○— — —○ 28	✗	
	25 ○— — —○ 27		✗
	26 ○— — —○ 24	✗	

Contact Charts

The illustration shows decks one and two of a typical Series 24 LOR and graphically describes the operation of the contacts.

Target Used with Lock-out Relays

All the Lock-out Relays have a mechanical target as part of the nameplate — BLACK for RESET and ORANGE for TRIP. This indicates the condition of the LOR. The target resets when the LOR resets (with the exception of the high-speed trip electric-reset LOR/ER and self-reset LOR/SR where the memory target is manually reset).

Contact Ratings

Contact ratings for LOR

Contact Circuit Volts	Interrupting Rating (AMPS)		Short Time Rating** (AMPS)	Continuous Rating (AMPS)
	Resistive	Inductive*		
	Single Contact	Single Contact		
125VDC	5	2	60	30
250VDC	3	1	60	30
120VAC	20	20	60	30
240VAC	15	10	60	30
480VAC	7.5	5	60	30
600VAC	6	5	60	30

* AC PF = 0.4; DC L/R = 0.04 ** Short time current is for one minute

The interrupting ratings are based on a 10,000 operation life at rated voltage with no extensive burning of contacts. Short time and continuous ratings are based on temperature rise in contact members and supporting parts not to exceed 50° above ambient.

UL file No. E80080 • IEEE Std. 323 - 1984 • CE
 • IEEE Std. 344 - 1987

Trip Speed in Lock-Out Relays

The manual reset Series 24 LOR has a nominal trip speed of less than 8 milliseconds at rated voltage as tested on 10 deck units. There is very little difference in LORs with fewer decks.

Both the Electric Reset and the Self Reset LORs are available in Standard Trip and High-Speed Trip configurations.

- **Standard Trip** LOR/ER models operate in approximately 12–15 mSec and come equipped with standard LOR target nameplate or the optional LOR Monitor Nameplate.
- **High Speed Trip** LOR/ER models have the same 8 mSec trip speed as the Manual Reset LOR and come equipped with the Memory Target which displays an orange flag until it is manually reset.
- **Lighted Nameplate** with multiple LED indicators is available for all Series 24 LORs.



OPTIONS

Manual Reset LOR

Closing S1 energizes the linear solenoid $\frac{LOR}{T}$ which releases the trigger mechanism and causes the LOR to snap to the Trip position. The control deck blades rotate to interrupt current flow to the coil.

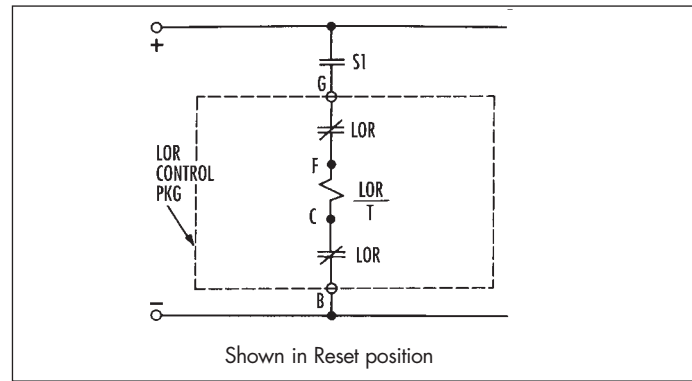

Electric Reset LOR

The Electric Reset LOR is tripped by the same method as the Manual Reset LOR. In the Trip position, closing S2 operates relay K1 which closes relay contact K1. The current then flows through solenoid $\frac{LOR}{R}$ which rotates the LOR/ER back into the reset position, while at the same time terminals A-B open to interrupt the K1 relay. Transition time is 80mSec.

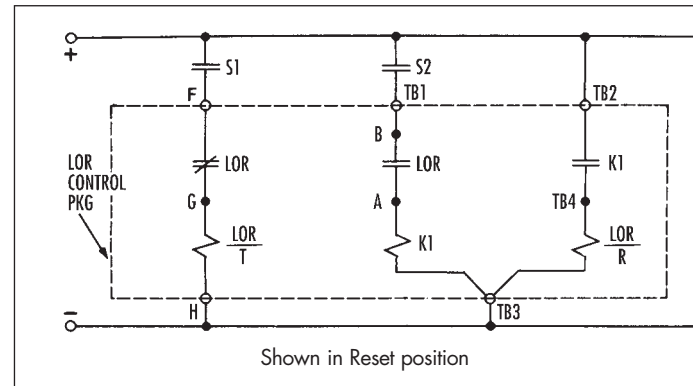

Self Reset LOR

The Self Reset LOR is a special Electric Reset LOR which can be both TRIPPED and RESET from a single command contact. In both diagrams below, closing S1 will cause the LOR/SR to snap to the TRIP position. The unit will remain in TRIP as long as S1 remains closed. When S1 is opened, K1 is picked up and the LOR/SR returns to the reset position. The Instant

Reset LOR/SR will reset itself within 80mS of the opening of S1. The Time Delay LOR/SR has factory preset circuitry which causes a time delay of .3 to .6 seconds from the time S1 opens until the LOR/SR contacts reclose.

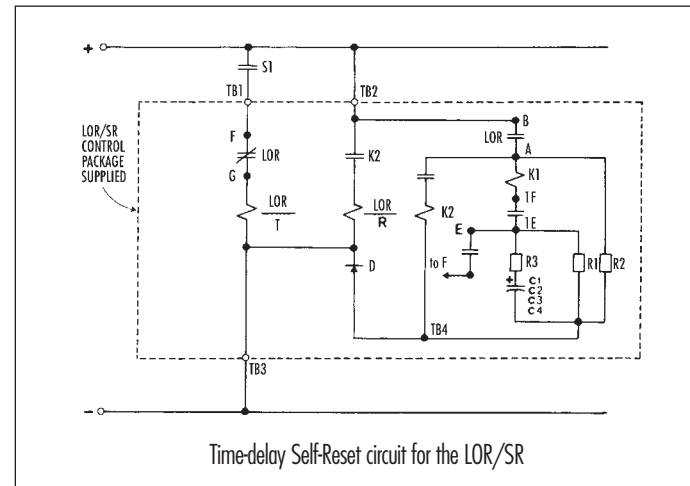
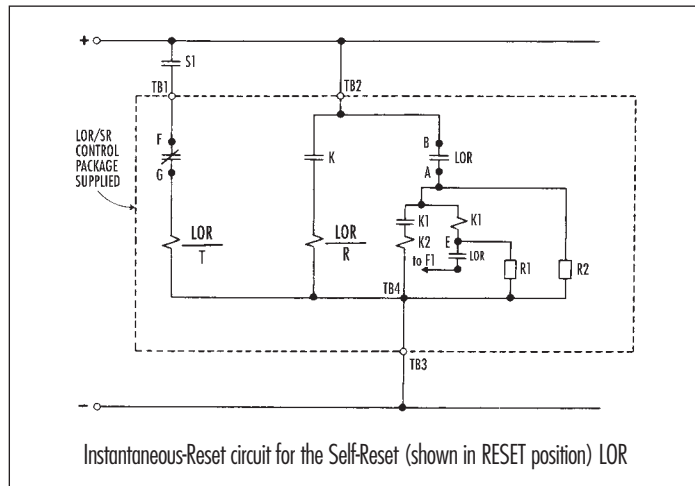



SERIES 24 LOCK-OUT RELAYS

SERIES 24 MANUAL RESET LOR

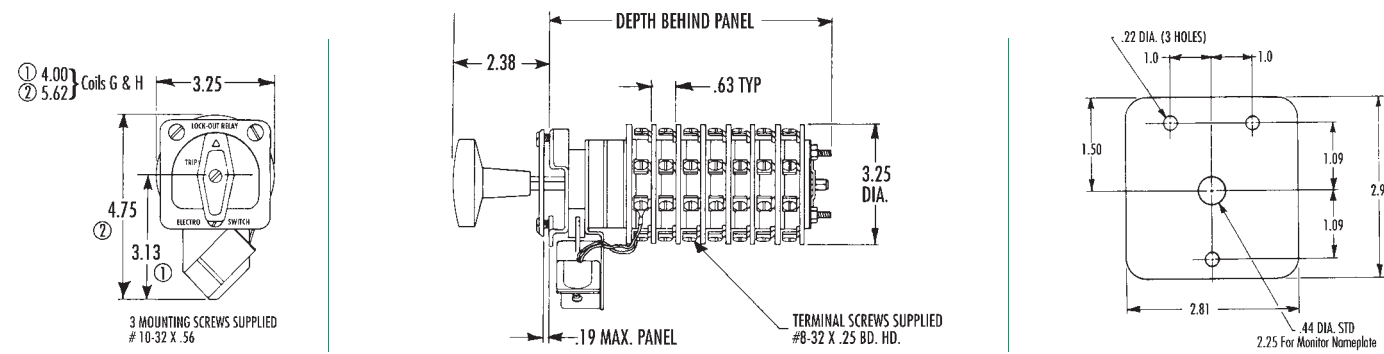

SERIES 24 LOR/ER, LOR/SR ELECTRIC RESET & SELF-RESET

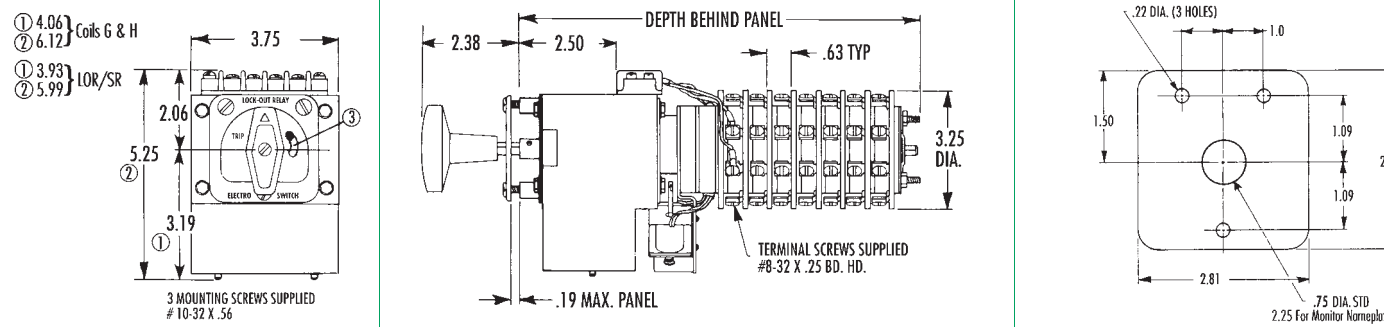

DEPTH BEHIND PANEL

NO. OF DECKS	MAN. RESET LOR	HI SPEED TRIP LOR/ER	LOR/ER AND INSTANT LOR/SR TIME DELAY	RESET LOR/SR
1	3.63	—	—	—
2	4.38	—	—	—
3	4.75	8.00	8.00	8.63
4	5.50	—	—	—
5	6.25	9.75	9.75	10.38
6	7.50	—	—	—
7	8.13	—	—	11.63
8	8.50	11.63	11.63	—
10	9.63	12.90	—	—

COIL BURDEN DATA

COIL	COIL CIRCUIT VOLTS	TRIP COIL		RESET COIL	
		COIL CIRCUIT DC OHMS @25°C	BURDEN (AMPS) AT RATED VOLTAGE	COIL CIRCUIT DC OHMS @25°C	BURDEN (AMPS) AT RATED VOLTAGE
A	24VDC	3.3	7.3	.7	33.8
B	24VDC	7.7	3.1	—	—
C	48VDC	13.0	3.7	3.0	15.9
D	125VDC	27.0	4.6	12.4	10.1
E	125VDC	50.0	2.5	—	—
F	250VDC	104.0	2.4	80.6	3.1
G	125VDC	27.0	4.6	—	—
H	250VDC	104.0	2.4	—	—
K	125VDC	27.0	4.6	—	—

TRIP COIL VOLTAGE DATA

Coil	Nominal Voltage	Threshold Voltage	Operating Range
A	24VDC	6VDC	10 - 40VDC
B	24VDC	9VDC	18 - 50VDC
C	48VDC	12VDC	24 - 70VDC
D	125VDC	16VDC	30 - 140VDC
	120VAC	20VAC	30 - 140VAC
E	125VDC	23VDC	45 - 140VDC
F	250VDC	33VDC	70 - 280VDC
	240VAC	40VAC	60 - 280VAC
G	125VDC	70VDC	90 - 140VDC
H	250VDC	140VDC	180 - 280VDC
K	125VDC	16VDC	100-150VDC

RESET COIL VOLTAGE DATA

Coil	Nominal Voltage	Normal Voltage Operating Range
A	24VDC	19.2 to 28VDC
C	48VDC	38.4 to 57.6VDC
D	125VDC	100 to 150VDC
F	250VDC	200 to 275VDC



SERIES 24 LOCK-OUT RELAYS

LOR RESPONSE TIMES*

Time to Close Normally Open Contacts

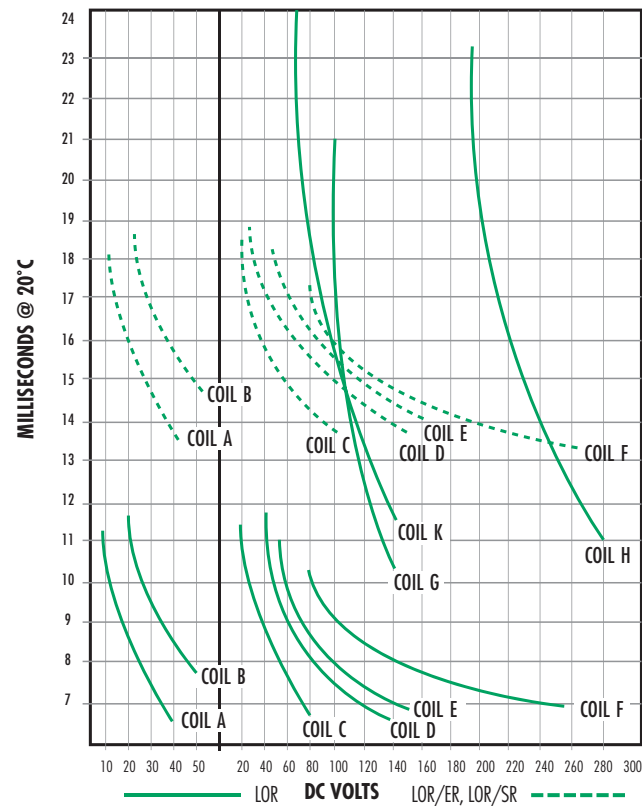

*For AC Applications refer to Trip Coil Voltage Data on page 47

LOR CURRENT

Voltage Characteristics Of The Trip Coils

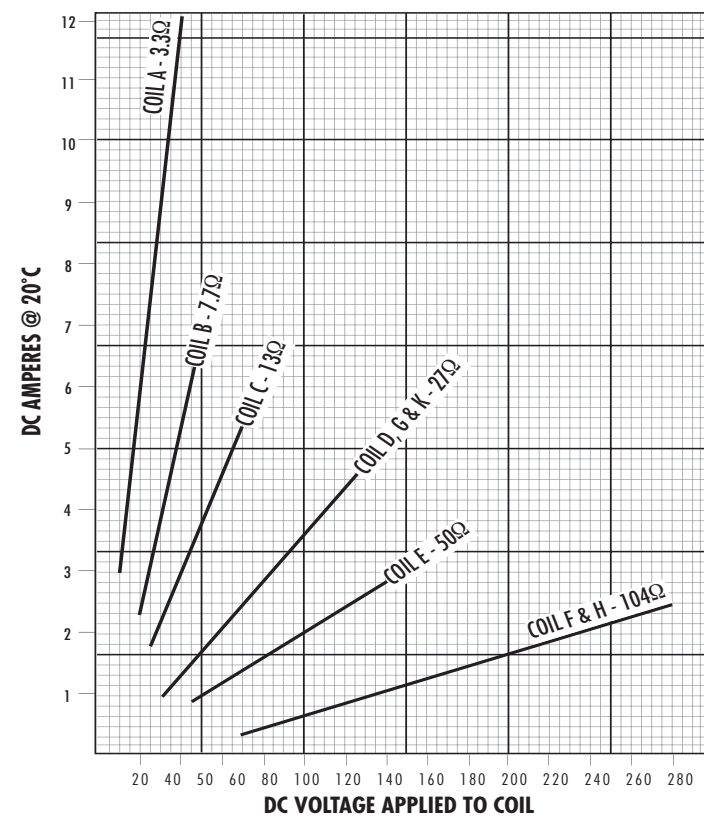

ORDERING INFORMATION

Selecting a Series 24 Lock-Out Relay:

1. Select type of LOR (Manual Reset, Electric Reset or Self Reset).
2. Fill out appropriate ordering matrix.
3. When selecting Trip and Reset Coils use information from tables below.
4. Contact factory for custom features and nonstandard configurations.

Manual Reset LOR

78

Model | **No. of Decks** | **Trip Coil**
 (See Page 47)

78 = LOR 03 = 3 08 = 8
 05 = 5 10 = 10

A = Coil A D = Coil D G = Coil G
 B = Coil B E = Coil E H = Coil H
 C = Coil C F = Coil F K = Coil K

Electric Reset LOR/ER

78

Model | **Reset Coil**
 78 = LOR A = 24VDC D = 125VDC
 C = 48VDC F = 250VDC

Configuration | **Trip Coil**
 2 = Std. Trip LOR/ER
 3 = Hi-Spd. Trip LOR/ER
 (See Page 47)

No. of Decks | **Trip Coil**
 3 = 3 A = Coil A F = Coil F
 5 = 5 B = Coil B G = Coil G
 8 = 8 C = Coil C H = Coil H
 (10 Consult Factory) D = Coil D K = Coil K
 E = Coil E

Self Reset LOR/SR

78 **D**

Model | **Reset Coil**
 78 = LOR D = 125VDC

Configuration | **Trip Coil**
 4 = Std. Trip, Instant Reset, LOR/SR
 5 = Std. Trip, Time Delay Reset, LOR/SR
 6 = Hi-Spd. Trip, Instant Reset, LOR/SR
 7 = Hi-Spd. Trip, Time Delay Reset, LOR/SR

No. of Decks
 3 = 3
 5 = 5
 7 = 7 (time delay units only)
 8 = 8 (instant reset units only)

D, E, F, G Available for Std. Trip LOR/SR
 D, E, F Available for Hi-Spd. Trip LOR/SR



SLOR Serial Lock-Out Relay

Automation That Keeps A Handle On System Protection And Control

The Series 24 Serial (Communication) Lock-Out Relay (SLOR) with Certified DNP 3.00 or Modbus expands the functionality of our field proven Series 24 Electric Reset and Self Reset Lock-Out Relay in a single unit.

As an addressable network device, the SLOR provides Remote Trip Capability, Trip Coil Monitoring, Sequence of Events Reporting, System Battery Monitoring and Self-Diagnostic Reporting.

Most importantly, the SLOR design maintains the reliable hard-wired protective device trip and manual reset functions.

Features

- Manual Reset
- Construction and Contacting Based on the Field Proven LOR Device
- Mechanical Target Flag
- SLOR Trip Coil Integrity LED Monitors in Either Trip or Reset Position
- Serial Bus XMT/Rec Bicolor LED
- Local/Remote Mode Control with LED Status Indication
- LED Trip Signal Indication
- SLOR Position Status via SCADA
- 2 Additional Auxiliary Monitoring Inputs are Included
- Optional Programmable Self-Reset Timing and Logic

Cost-Saving Benefits

- Free up RTU Points
- Reduce Point to Point Wiring
- Simplify Testing for Easier Commissioning
- Minimal Training Required
- Simplify Load Shedding Applications
- May Eliminate Separate Devices
 - RTU
 - Discrete Battery Monitors
 - Local/Remote Control Switch
 - Coil Monitoring Lamp
 - Reclosing Relay
- Precise Sequence of Events Log with IRIG-B Input

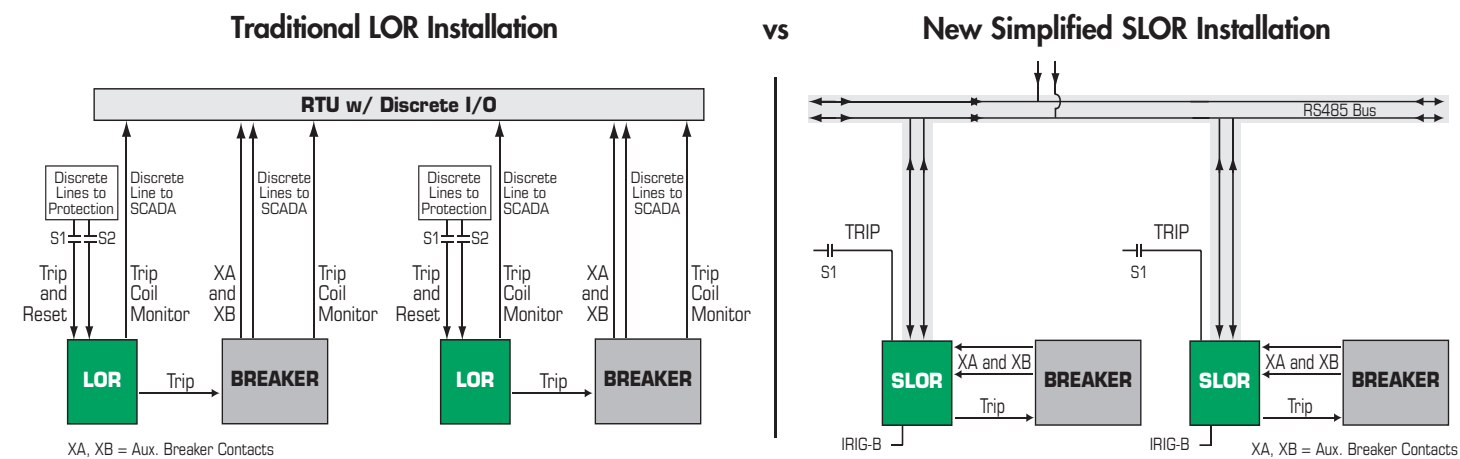

The simplified SLOR installation provides cost savings associated with wiring (wiring errors), testing, and commissioning.

Other Serial Control Devices From Electroswitch



**Series 24
SCSR Serial
Control Switch
Relay
(page 59)**



**Series 31
STR Serial
Tagging Relay**



**CIM
Serial Control
Indicator Module
(page 73)**



SLOR Serial Lock-Out Relay

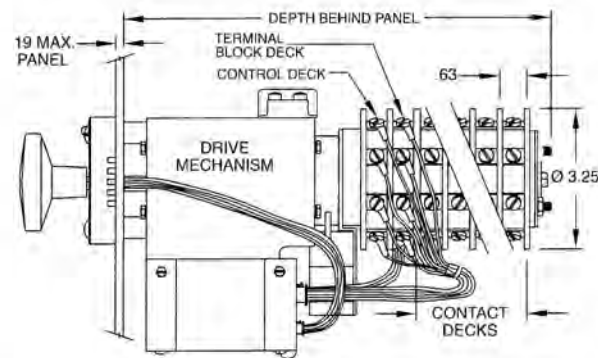
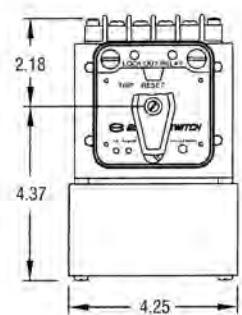

Nameplate – Standard Configuration

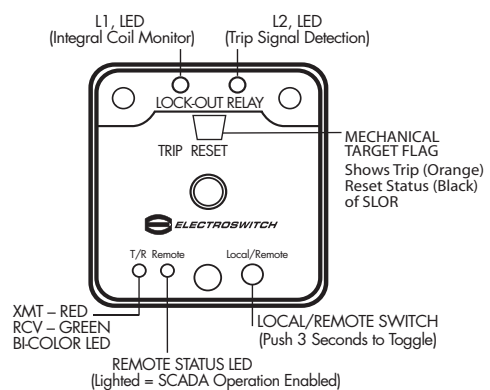

Specifications

Electrical

Continuous Ratings: 30A–600V
 Making Ability for CB Coils: 95A–125VDC
 UL Interrupt Ratings: 20A–120VAC, 15A–240VAC, 6A–600VAC, 3A–125VDC, 1A–250VDC
 Overload Current (50 Ops): 95A–120VAC, 65A–240VAC, 35A–600VAC
 Contact Resistance: .01 Ohms Maximum

Electronic

Baud Rate: 9600 Std; 1200, 4800, 19200 Selectable
 Transient Protection: Meets IEEE C37.90.1 and IEC 61000-4-4
 Self-Reset Time: Optional, Programmable, 0.1 to 60 Sec.

Mechanical

Decks: 3, 5, 8 Std. — Consult Factory for Options
 Contacts: 2 N/O and 2 N/C Per Deck
 Action: 45°
 Mounting: Panel Mount, 3 Hole Mounting,
 Panel Thickness: 3/16" Max. Standard — Consult Factory for Options
 Rotary Contacts: Double-Wiping Silver Overlay Phosphor-bronze
 Stationary Contacts: Silver Inlay in Brass, Silver Plated with Integral Screw Type Terminals
 Construction: Contacts Enclosed in Molded Phenolic Insulators

COIL BURDEN DATA

Voltage Range	Nominal Voltage	Trip Coil		Reset Coil and Electronics	
		Coil Circuit DC Ohms @ 25C	Burden (Amps) at Rated Voltage	Coil Circuit DC Ohms @ 25C	Burden (Amps) at Rated Voltage
C	48VDC	13.0	3.7	3.0	15.9
D	125VDC	27.0	4.6	12.4	10.1

For additional trip coil options, consult factory or see LOR-1 Tech Pub on website.

DNP 3.00 Protocol Note: Refer to ES-SLOR-1 Tech Pub on website or consult factory regarding DNP 3.00 implementation for your application.

Modbus Protocol Note: Refer to ES-SLOR-2 for further information.

Installation Connections (Rear View)

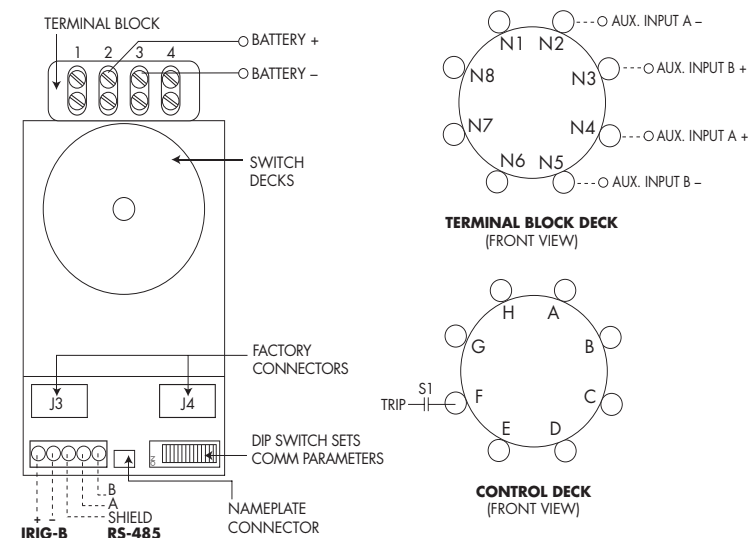

Required Ordering Information

- Protocol: DNP 3.00 or Modbus
Consult Factory for Other Protocols
- Baud Rate: 9600 Std., Others Available
- Reset: Electrical Reset Std., Self-Reset Selectable
- Handle: Oval Std.
- Voltage: 125VDC Std. or 48 VDC Std.
- Engraving, Std. Shown Above
(Other Engravings Available)
- Decks: Select 3, 5, or 8
- L1, L2 Replaceable LEDs
Green L1 & Red L2 are Std.
Color Options — (Amber, Red, Green, Blue, White)



TYPE WL-2 LOCK-OUT RELAYS

The Type WL-2 Lock-Out Relay was designed and manufactured by Westinghouse to provide dependable tripping in a variety of protection schemes. Since acquiring the line in 1988, Electroswitch has supplied hundreds of these rugged, reliable relays for both new applications as well as replacement units for the enormous installed base of WL-2s all over the world.

Features

- Low Current Magnetic Trip Mechanism
- Both Handle Trip and Non-Handle Trip Versions Available
- The Electroswitch Tradition of Quality, Value and Customer Service

How to Order

Contact the factory with the part number for the WL-2 Lock-Out Relay you are replacing or provide us with the following information:

- Number of N/O (Type A) and N/C (Type B) contacts required
- The required control voltage
- Whether the unit is to be Non-Handle Trip (standard) or Handle Trip (optional)

We will promptly respond with an approval drawing of the appropriate WL-2 Lock-Out Relay as well as any further technical information you may require.

Contact Ratings

Voltage	SINGLE CONTACT								TWO CONTACTS IN SERIES							
	INDUCTIVE AMPERES							RESISTIVE AMPS	INDUCTIVE AMPERES							RESISTIVE AMPS
	4.5mH	12mH	31mH	63mH	130mH	243mH			4.5mH	12mH	31mH	63mH	130mH	243mH		
125VDC	4.65	3.67	2.85	2.1	1.53	0.9	-	7.55	27.0	14.75	7.7	4.85	2.92	1.9	-	7.8
250VDC	1.6	1.6	1.0	1.0	0.98	0.78	-	1.6	6.4	5.0	3.85	3.1	2.4	1.6	-	6.7
500VDC	-	-	-	-	-	-	-	-	1.5	1.7	1.5	1.35	1.15	0.98	-	1.7
120VAC	-	-	-	-	-	-	7.53	7.95	-	-	-	-	-	-	68.0	-
240VAC	-	-	-	-	-	-	1.16	1.95	-	-	-	-	-	-	9.1	9.0
480VAC	-	-	-	-	-	-	.54	0.9	-	-	-	-	-	-	1.5	1.55

TYPE WL-2 LOCK-OUT RELAY

NOMINAL OPERATING VOLTAGE	AVERAGE COIL CURRENT	INDUCTANCE (H)	RESISTANCE (Ω)	IMPEDANCE (Ω)	MINIMUM PICK UP	OPERATING TIME AVERAGE	
						CYCLES	mSEC
24VDC	3.6A	.0029	6.6		19VDC	1.06	17.7
48VDC	7.3A	.0029	6.6		19VDC	.96	16.0
125VDC	1.2A	.030	104		90VDC	1.05	17.5
250VDC	2.4A	.030	104		90VDC	1.01	16.8
120VAC	1.4A	.030		85	90VAC	1.58	26.3
120VAC RECTIFIED	1.4A	.030		85	90VAC	1.08	18.0
240VAC	3.0A	.030		80	90VAC	1.54	25.7
240VAC RECTIFIED	3.0A	.030		80	90VAC	1.05	17.5
480VAC	6.0A	.030		80	90VAC	1.50	25.0



Switch Style Numbers					Handle Trip 24-48V Dc	120V-240V 60Hz with Rectifier	120V-240V 60Hz 125-250V Dc	480V 60HZ	Non-Handle Trip 24V-48V Dc	120-240V 60Hz with Rectifier	120V-240V 60Hz 125-250V Dc	480V 60HZ
Fig.	No. of Stages	Contacts Available NO	NC	No. of Paired*	Six (6) Contact Frame WL-2 Switches							
1	1	2	2	1	796A201G01	796A201G03	796A201G05	796A201G07	796A201G02	796A201G04	796A201G06	796A201G08
2	2	4	6	3	796A205G01	796A205G03	796A205G05	796A205G07	796A205G02	796A205G04	796A205G06	796A205G08
3	2	6	4	3	796A204G01	796A204G03	796A204G05	796A204G07	796A204G02	796A204G04	796A204G06	796A204G08
4	3	6	10	5	796A210G01	796A210G03	796A210G05	796A210G07	796A210G02	796A210G04	796A210G06	796A210G08
5	3	8	8	5	796A208G01	796A208G03	796A208G05	796A208G07	796A208G02	796A208G04	796A208G06	796A208G08
6	3	10	6	5	796A209G01	796A209G03	796A209G05	796A209G07	796A209G02	796A209G04	796A209G06	796A209G08
7	4	8	14	7	796A212G01	796A212G03	796A212G05	796A212G07	796A212G02	796A212G04	796A212G06	796A212G08
8	4	10	12	7	796A202G01	796A202G03	796A202G05	796A202G07	796A202G02	796A202G04	796A202G06	796A202G08
9	4	12	10	7	796A213G01	796A213G03	796A213G05	796A213G07	796A213G02	796A213G04	796A213G06	796A213G08
10	4	14	8	7	796A211G01	796A211G03	796A211G05	796A211G07	796A211G02	796A211G04	796A211G06	796A211G08
11	5	10	18	9	796A215G01	796A215G03	796A215G05	796A215G07	796A215G02	796A215G04	796A215G06	796A215G08
12	5	12	16	9	796A225G01	796A225G03	796A225G05	796A225G07	796A225G02	796A225G04	796A225G06	796A225G08
13	5	14	14	9	796A200G01	796A200G03	796A200G05	796A200G07	796A200G02	796A200G04	796A200G06	796A200G08
14	5	16	12	9	796A224G01	796A224G03	796A224G05	796A224G07	796A224G02	796A224G04	796A224G06	796A224G08
15	5	18	10	9	796A214G01	796A214G03	796A214G05	796A214G07	796A214G02	796A214G04	796A214G06	796A214G08
16	6	12	22	11	796A217G01	796A217G03	796A217G05	796A217G07	796A217G02	796A217G04	796A217G06	796A217G08
17	6	14	20	11	796A228G01	796A228G03	796A228G05	796A228G07	796A228G02	796A228G04	796A228G06	796A228G08
18	6	16	18	11	796A227G01	796A227G03	796A227G05	796A227G07	796A227G02	796A227G04	796A227G06	796A227G08
19	6	18	16	11	796A218G01	796A218G03	796A218G05	796A218G07	796A218G02	796A218G04	796A218G06	796A218G08
20	6	20	14	11	796A226G01	796A226G03	796A226G05	796A226G07	796A226G02	796A226G04	796A226G06	796A226G08
21	6	22	12	11	796A216G01	796A216G03	796A216G05	796A216G07	796A216G02	796A216G04	796A216G06	796A216G08
22	7	14	26	13	796A220G01	796A220G03	796A220G05	796A220G07	796A220G02	796A220G04	796A220G06	796A220G08
23	7	16	24	13	796A243G01	796A243G03	796A243G05	796A243G07	796A243G02	796A243G04	796A243G06	796A243G08
24	7	18	22	13	796A242G01	796A242G03	796A242G05	796A242G07	796A242G02	796A242G04	796A242G06	796A242G08
25	7	20	20	13	796A241G01	796A241G03	796A241G05	796A241G07	796A241G02	796A241G04	796A241G06	796A241G08
26	7	22	18	13	796A230G01	796A230G03	796A230G05	796A230G07	796A230G02	796A230G04	796A230G06	796A230G08
27	7	24	16	13	796A229G01	796A229G03	796A229G05	796A229G07	796A229G02	796A229G04	796A229G06	796A229G08
28	7	26	14	13	796A219G01	796A219G03	796A219G05	796A219G07	796A219G02	796A219G04	796A219G06	796A219G08
29	8	16	30	15	796A222G01	796A222G03	796A222G05	796A222G07	796A222G02	796A222G04	796A222G06	796A222G08
30	8	18	28	15	796A248G01	796A248G03	796A248G05	796A248G07	796A248G02	796A248G04	796A248G06	796A248G08
31	8	20	26	15	796A247G01	796A247G03	796A247G05	796A247G07	796A247G02	796A247G04	796A247G06	796A247G08
32	8	22	24	15	796A246G01	796A246G03	796A246G05	796A246G07	796A246G02	796A246G04	796A246G06	796A246G08
33	8	24	22	15	796A223G01	796A223G03	796A223G05	796A223G07	796A223G02	796A223G04	796A223G06	796A223G08
34	8	26	20	15	796A245G01	796A245G03	796A245G05	796A245G07	796A245G02	796A245G04	796A245G06	796A245G08
35	8	28	18	15	796A244G01	796A244G03	796A244G05	796A244G07	796A244G02	796A244G04	796A244G06	796A244G08
36	8	30	16	15	796A221G01	796A221G03	796A221G05	796A221G07	796A221G02	796A221G04	796A221G06	796A221G08
Wiring Diagram — Figures					A	A	A	C	A	A	A	C
					Twelve (12) Contact Frame WL-2 Switches							
37	1	5	4	4	796A231G01	796A231G03	796A231G05	796A231G07	796A231G02	796A231G04	796A231G06	796A231G08
33	2	11	10	10	796A232G01	796A232G03	796A232G05	796A232G07	796A232G02	796A232G04	796A232G06	796A232G08
39	3	17	16	16	796A233G01	796A233G03	796A233G05	796A233G07	796A233G02	796A233G04	796A233G06	796A233G08
40	4	23	22	22	796A234G01	796A234G03	796A234G05	796A234G07	796A234G02	796A234G04	796A234G06	796A234G08
41	5	29	28	28	796A235G01	796A235G03	796A235G05	796A235G07	796A235G02	796A235G04	796A235G06	796A235G08
42	6	35	34	34	796A236G01	796A236G03	796A236G05	796A236G07	796A236G02	796A236G04	796A236G06	796A236G08
Wiring Diagram — Figures					B	B	B	D	B	B	B	D

* A pair of contacts are those having adjacent stationary terminals served by the same moving contact. When the interrupted current of a normal closed contact exceeds the rating listed for single contacts, the adjacent "make" contacts should not be used. This column indicates the number of these pairs per switch.

Wiring Diagrams — 24 thru 250 Volts

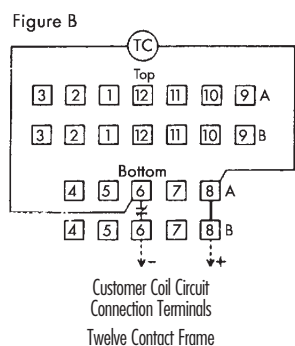
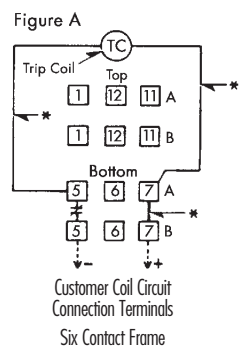

480 Volts — Two Coil Cutoff Contacts Wired in Circuit

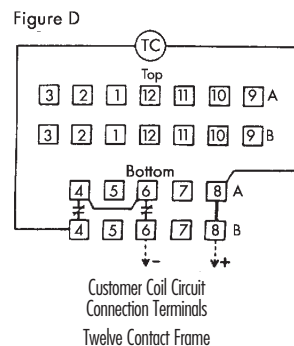
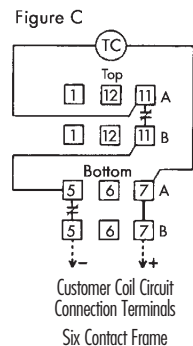



TYPE WL LOCK-OUT RELAY

The Type WL Lock-Out Relay product line was also acquired from Westinghouse in 1988. Countless Type WLs are still providing reliable protection in older facilities decades after they were first installed. Electroswitch is pleased to announce that we can provide replacement

units for most of the WLs still in service. Please contact us with the WL part number of the switch you are replacing and we will be happy to respond with an approval drawing or a suggested replacement if your WL cannot be duplicated.

TABLE I: WL SWITCH STYLES (less coils)

No. of Stages	Style Numbers Without Coils				Rotor Contacts												
	Modern Handle		Heavy-Duty Handle		Coil	A = Contact Open in Reset. Closed in Trip Position. N.O. B = Contact Closed in Reset. Open in Trip Position. N.C.											
	Non-Trip by Handle	Trip by Handle	Non-Trip by Handle	Trip by Handle		1-2 ①	3-4	5-6	7-8	9-10	11-12	13-14	15-16	17-18	19-20		
2	422D949G01	422D950G01	422D949G08	422D950G08	B	A	A										
3	422D949G02	422D950G02	422D949G09	422D950G09	B	A	A	A									
4	422D949G03	422D950G03	422D949G10	422D950G10	B	A	A	A	A								
5	422D949G04	422D950G04	422D949G11	422D950G11	B	A	A	A	A	A							
6	422D949G05	422D950G05	422D949G12	422D950G12	B	A	A	A	A	A	A						
8	422D949G06	422D950G06	422D949G13	422D950G13	B	A	A	A	A	A	A	A					
10	422D949G07	422D950G07	422D949G14	422D950G14	B	A	A	A	A	A	A	A	A				
2	422D949G15	422D950G15	422D949G41	422D950G41	B	B	A										
3	422D949G16	422D950G16	422D949G42	422D950G42	B	B	A	A									
4	422D949G17	422D950G17	422D949G43	422D950G43	B	B	A	A	A								
5	422D949G18	422D950G18	422D949G44	422D950G44	B	B	A	A	A	A							
6	422D949G19	422D950G19	422D949G45	422D950G45	B	B	A	A	A	A	A						
8	422D949G20	422D950G20	422D949G46	422D950G46	B	B	A	A	A	A	A	A					
10	422D949G21	422D950G21	422D949G47	422D950G47	B	B	A	A	A	A	A	A	A				
3	422D949G22	422D950G22	422D949G48	422D950G48	B	B	B	A									
4	422D949G23	422D950G23	422D949G49	422D950G49	B	B	B	A	A								
5	422D949G24	422D950G24	422D949G50	422D950G50	B	B	B	A	A	A							
6	422D949G25	422D950G25	422D949G51	422D950G51	B	B	B	A	A	A	A						
8	422D949G26	422D950G26	422D949G52	422D950G52	B	B	B	A	A	A	A	A					
10	422D949G27	422D950G27	422D949G53	422D950G53	B	B	B	A	A	A	A	A	A				
4	422D949G28	422D950G28	422D949G54	422D950G54	B	B	B	B	A								
5	422D949G29	422D950G29	422D949G55	422D950G55	B	B	B	B	A	A							
6	422D949G30	422D950G30	422D949G56	422D950G56	B	B	B	B	A	A	A						
8	422D949G31	422D950G31	422D949G57	422D950G57	B	B	B	B	A	A	A	A					
10	422D949G32	422D950G32	422D949G58	422D950G58	B	B	B	B	A	A	A	A	A				
5	422D949G33	422D950G33	422D949G59	422D950G59	B	B	B	B	B	A							
6	422D949G34	422D950G34	422D949G60	422D950G60	B	B	B	B	B	A	A						
8	422D949G35	422D950G35	422D949G61	422D950G61	B	B	B	B	B	A	A	A					
10	422D949G36	422D950G36	422D949G62	422D950G62	B	B	B	B	B	A	A	A	A				
6	422D949G37	422D950G37	422D949G63	422D950G63	B	B	B	B	B	B	A						
8	422D949G38	422D950G38	422D949G64	422D950G64	B	B	B	B	B	B	A	A	A				
10	422D949G39	422D950G39	422D949G65	422D950G65	B	B	B	B	B	B	A	A	A	A			

① On 250 volts dc control circuits this contact must be connected in series with coil contact.

TABLE II: COIL OPERATING CHARACTERISTICS

Coil part numbers must be specified at the time of order. Those marked with an asterisk (*) are considered to be standard for the operating voltage indicated. These coils should not be used for 5 ampere series trip operation from secondary of current transformers, as the burden is too great. Time is in milliseconds. Time may vary slightly for AC tripping, depending on point of AC cycles at which the coil is energized.

Coil Code	Coil Style Number	Direct Current		Alternating Current - 60 Cycles							
		Ohms Resistance	Minimum Trip DC Volts	Control Voltage-DC				Ohms impedance (not tripped)	Minimum Trip AC Volts	Control Voltage-AC	
				24	48	125	250			110	220
				Time in Milliseconds						Time in Milliseconds	
A	701B500G01	.73	8.7	*16				6.2	50	*16	
B	701B501G01	2.68	17.1		16			21.0	95	19	16
C	701B502G01	4.05	21.4		*17			30.0	115		16
D	701B503G01	6.2	27.0		19	13		43.0	135		*17
E	701B504G01	8.6	31.0			14		52.0	155		18
F	701B505G01	12.2	33.0			14		97.0	200		
G	701B506G01	18.5	44.0			16		140.0	243		
H	701B507G01	28.0	54.0			*17	14	208.0	297		
I	701B508G01	45.5	70.0			19	15				
J	701B509G01	59.0	84.0				*16				
K	701B510G01	104.0	111.0				17				



CONTROL SWITCH RELAYS

Electroswitch Control Switch Relays (CSR) combine the function of a control switch with a remote controlled solenoid allowing one device to do both the manual and supervisory control function in the control of power circuit breakers. They eliminate the need to redesign substations for redundant separate relays when manual substations convert to supervisory control. CSRs provide manual or electric control switch operation by supervisory control. The CSR looks, acts, and feels identical to a control switch.

Note: The Series 24 CSR Class 1E utility products comply with the following Nuclear Standards: ANSI/IEEE C37.90, ANSI/IEEE C37.90.01, ANSI/IEEE C37.98, ANSI/IEEE C37.105, ANSI/IEEE 323, ANSI/IEEE 344, ANSI/ASME NQA-1.

Series 24 Control Switch Relays

- HIGH QUALITY**
 - Designed and manufactured to the highest standards in the industry
 - Qualified to UL, CSA, ANSI/IEEE 37.90 and 37.90 .1
- VERSATILITY**
 - Replaces a manual breaker switch, interposing relays, and associated wiring
 - Direct retrofit to existing manual breaker control switch
 - Electric or manual operation
 - Three circuits to satisfy different industry applications
 - Multiple voltages: 48VDC, 125VDC, standard, others available
 - All standard Series 24 circuit breaker control switch contacting (see page 17) available
 - Available with custom contacting (consult factory)
- SAFETY**
 - Target flag agreement (regardless of manual or electric trip)
 - Available with SCADA disable for operator safety during service
 - 1E Nuclear qualified
- AVAILABILITY**
 - Virtually all Universal Circuits in standard voltages of the Series 24 CSRs are available from stock for quick delivery. See pg.14 (Switch Section) for Series 24 Universal Circuits.
- SERVICE**
 - The Electroswitch team of Customer Service and Applications Professionals stand behind every Electroswitch product. Let us put over 50 years of know-how to work for you!

Basic Circuit Operation

The control of the CSR Control Switch Relay for electric operation requires no special wiring. It only requires two contacts (S1 and S2) to command the CSR to either the TRIP or CLOSE position. Low level contacts (rated 1 ampere) may be used since S1 and S2 do not control the rotary drive solenoid directly.

The standard station control bus voltage is used on all three circuits. The device, when shown in the following figures is in the vertical NORMAL position. The CSR coil form shown on the figures represents the rotary solenoid that drives the CSR. Its operation is further described later. LS1 is a linear solenoid within the device that changes the sense of direction of the CSR from left (TRIP) to right (CLOSE). The contacts shown as CSR are contacts within the device. Other components are shown by conventional designations.

Mechanical Target

When the CSR Switch handle is turned, a mechanical target contained in the nameplate is turned as well (GREEN for TRIP, RED for CLOSE). The target remains latched when the handle returns to normal position and always shows the last active position.

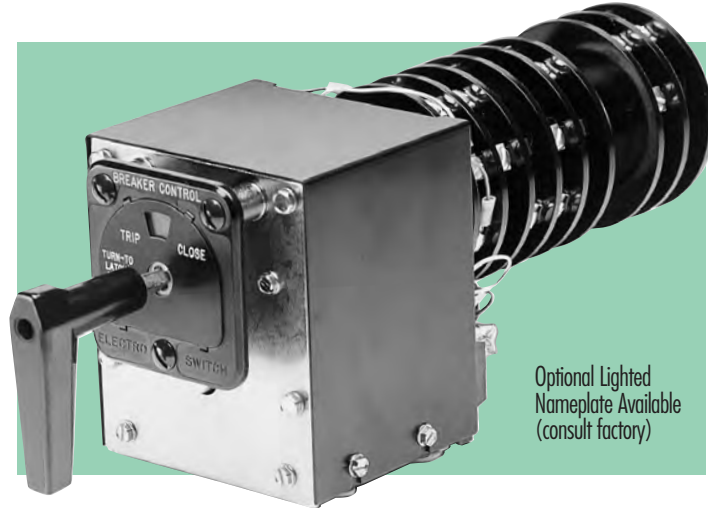

Optional Lighted Nameplate Available (consult factory)

Contact Deck Arrangement

The blade and terminal configuration enables the use of multiple contacts in the same deck, and simple stacking procedures enable the fabrication of many independent contacts in one relay. Specifically, two N/O contacts or two N/C contacts are provided in each deck, and ten decks can be stacked, resulting in a relay with up to twenty contacts.

NOTES:

- The numbers are the same for all decks
- "n" becomes the deck number, e.g., 11 and 12 are CLOSE contacts on deck 1; 51 and 52 are CLOSE contacts on deck 5
- TRIP plus normal after TRIP contacts have the same contact numbers as the normal position contacts
- CLOSE plus normal after CLOSE contacts have the same contact numbers as the CLOSE contacts
- Decks with slip contacts are placed at end of switch/relay

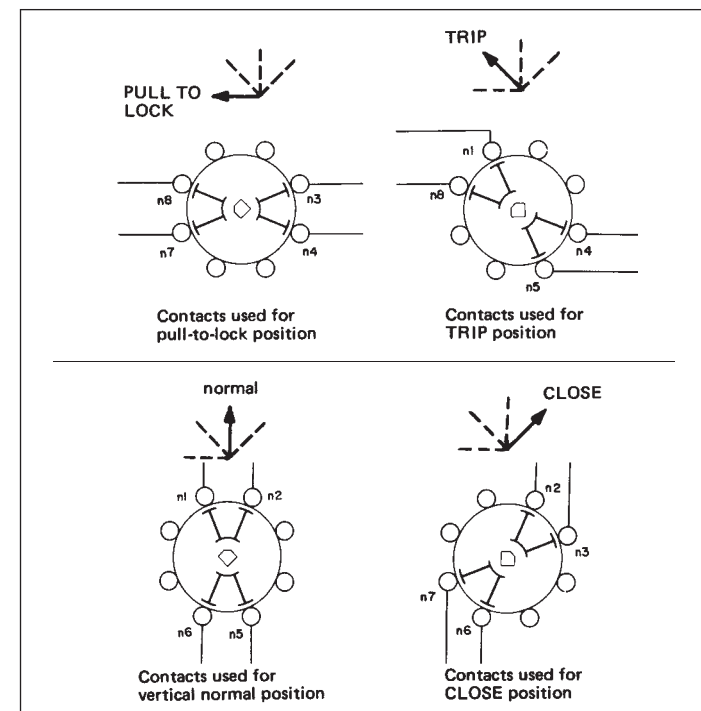



Transient Protection

The CSR Control Switch Relay is designed and tested to operate reliably in a normal power industry environment. This includes being subjected to transients on the control bus up to 3.5KV. Since the CSR is normally isolated from the bus, it will experience transients only if they occur in the operating mode. This precludes the possibility of a detrimental, accumulating affect over the life of the unit. As such, no transient protection is needed with circuits B and C. Circuit A with its voltage divider circuit does remain on the bus and therefore contains a bipolar diode, as previously explained, to clip the transients to an acceptable value.

Because of the nature of the operation of the rotary solenoid, the CSR does generate transients that may be of interest to the user. These transients are less than 2KV and generally in the 1.5KV to 1.8KV range. When used in conjunction with unprotected static devices, like solid state relays, a bipolar diode is recommended across the rotary solenoid and the relay contact.

The CSR is available with Serial Communication Control.

Coil Voltage Data

COIL	COIL CIRCUIT VOLTS	COIL CIRCUIT DC OHMS @ 25°C	BURDEN (AMPS) AT RATED VOLTAGE
C	48VDC	4.83	9.9
D	125VDC	18.96	6.6

24VDC and 250VDC available – Consult factory.

Contact Ratings

CONTACT CIRCUIT VOLTS	INTERRUPTIVE RATING (AMPS)		SHORT TIME RATING* (AMPS)	CONTINUOUS RATING (AMPS)
	RESISTIVE SINGLE CONTACT	INDUCTIVE SINGLE CONTACT		
12VDC	–	–	60	30
24VDC	–	–	60	30
48VDC	–	–	60	30
125VDC	3	3	60	30
250VDC	–	–	–	–
600VDC	–	–	–	–
120VAC	20	20	60	30
240VAC	15	15	60	30
480VAC	10	10	60	30
600VAC	6	6	60	30

* Short time current is for one minute.

Coil Burden Data

COIL	NOMINAL VOLTAGE	VOLTAGE RANGE
C	48VDC	41-56VDC
D	125VDC	106-140VDC

OPTIONS

Three basic circuits are available to satisfy different power industry applications.

Circuit B One Second Time Delay With Anti-Pumping Circuitry

Circuit B has a time delay that holds the CSR in the command position for 1 sec. It also has anti-pumping circuitry so that the command contact may be closed indefinitely (greater than 100 msec).

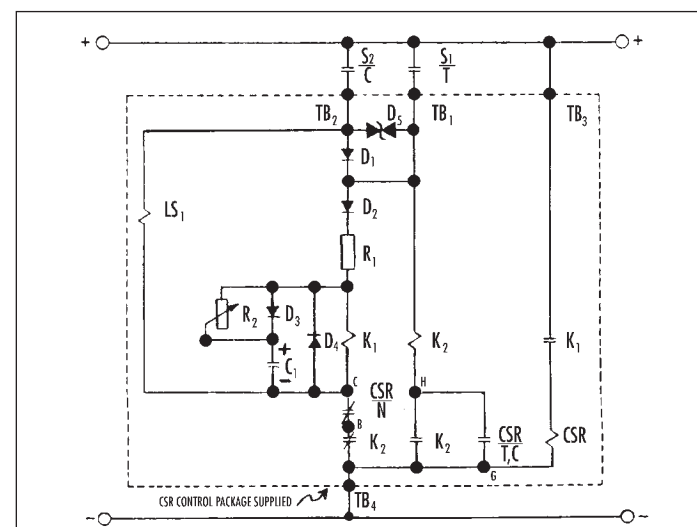

Circuit B
One Second Time Delay with Anti-Pumping Circuitry

Circuit C Time Delay And Anti-Pumping Controlled By the Command Contacts

Circuit C has no built in time delay. It exactly follows (or is a slave to) the operation of the command contact (maximum 15 second time delay).

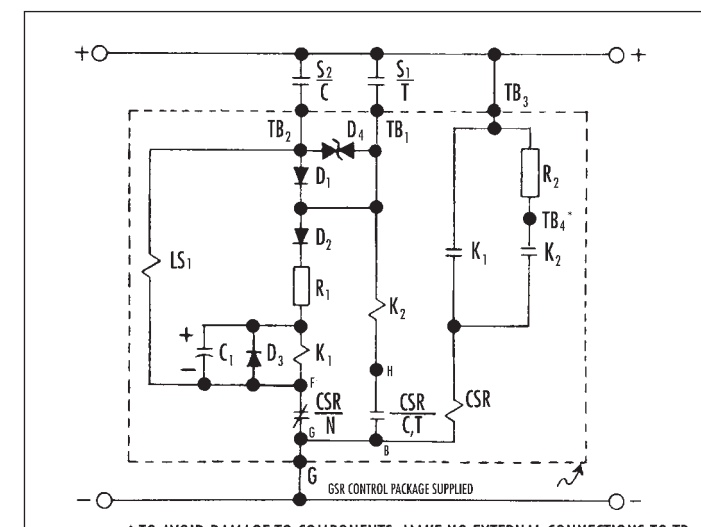

Circuit C
Time Delay with Anti-Pumping Controlled by the Command Contacts



CONTROL SWITCH RELAYS

Circuit A One To Three Second Time Delay With No Anti-Pumping Circuitry - *Not Recommended Where SCADA Timing Sequence is Greater Than Three Seconds.*

Circuit A has a factory adjustable time delay that holds the CSR in the commanded position for 1 to 3 sec. The command contact closure time should be greater than 100 msec and less than the time delay setting (to avoid pumping). This circuit is not recommended for applications where the SCADA timing sequence is greater than three seconds as it will cause pumping.

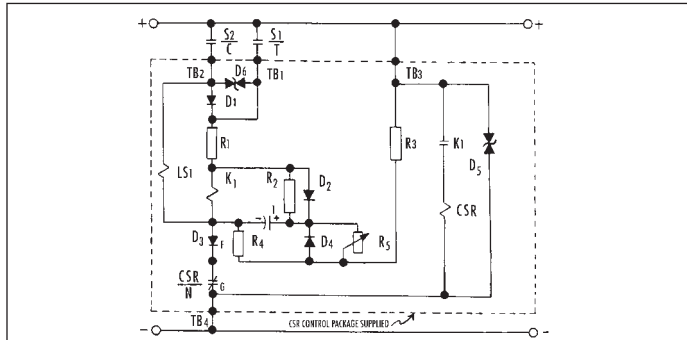

Circuit A One to Three Second Time Delay with No Anti-Pumping Circuitry

Contact Chart

DECKS	CONTACTS	POS.			
		TRIP	NAT	NAC	CLOSE
1	12 ○— — —○ 13				✗
	16 ○— — —○ 17				✗
2	21 ○— — —○ 28	✗			
	24 ○— — —○ 25	✗			
3	31 ○— — —○ 32		✗	✗	
	35 ○— — —○ 36		✗	✗	
4	42 ○— — —○ 43			✗	✗
	46 ○— — —○ 47			✗	✗
5	51 ○— — —○ 52	✗	✗		
	55 ○— — —○ 56	✗	✗		

nat = normal after TRIP
nac = normal after CLOSE

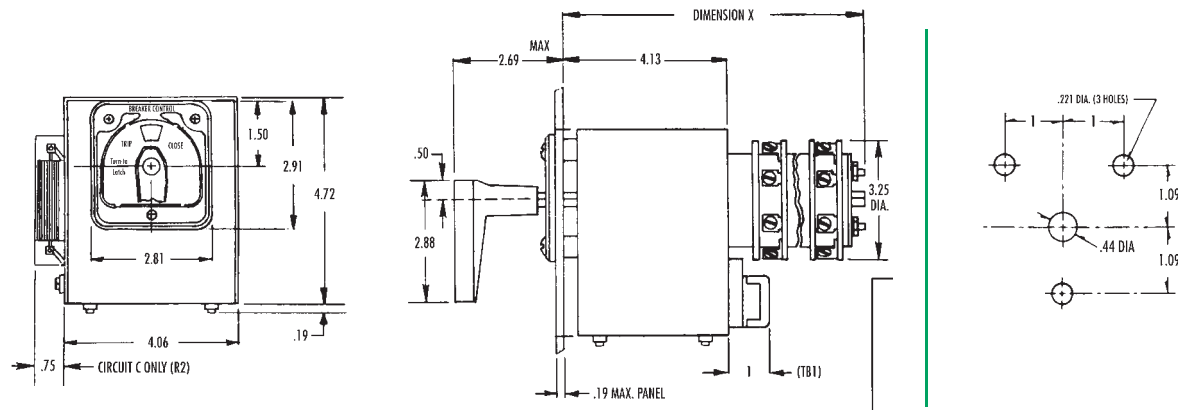
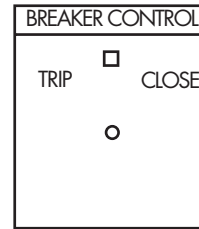

DEPTH BEHIND PANEL (DIM X)

No of Decks	Standard Config.	With Slip Contacts
1	6.5	7.9
2	7.1	8.6
3	7.9	9.0
4	8.6	9.7
5	9.0	10.5
6	9.7	11.0

Series 24 CSR ORDERING INFORMATION

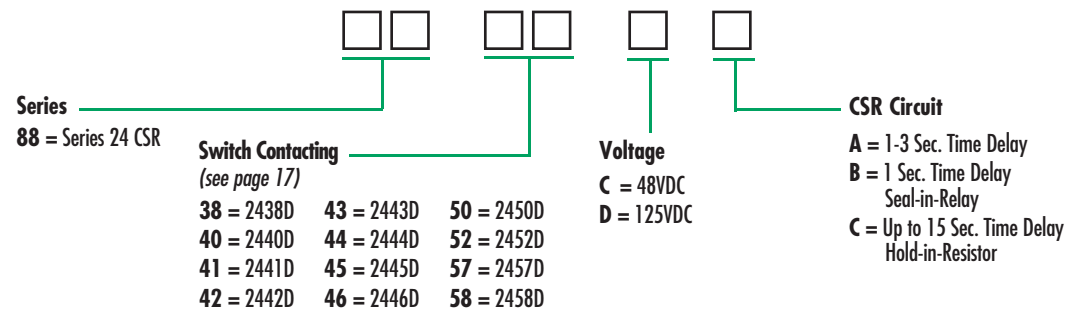

The circuit breaker control switch relays include an engraved nameplate, mechanical target, and pistol-grip handle. Circuits 50, 52 and 58 also have a Turn-To-Latch position. Also included are the control circuits previously explained.

CSR Control Switch Relays have the same flexibility of design as the Series 24 line of Instrument and Control Switches and are available with all the different contact configurations expected from this type of switch. Refer to switch section for details.



CONTROL SWITCH RELAYS WITH SCADA DISABLE

The Control Switch Relay with SCADA Disable (CSR/SD) operates like a standard CSR, allowing both SCADA and manual operation. Pushing in the handle disables remote operation leaving only Local/Manual operation possible, allowing testing and service to be performed safely. In addition, the CSR/SD also provides 2 N/O and 2 N/C contacts, push activated, for customer use as SCADA feedback of status indication.

Series 24 Control Switch Relays with SCADA Disable

The CSR/SD maintains all the exceptional quality and functionality of the CSR with the added benefit of a SCADA disable function. Consult factory for control circuit designs and ordering information.

OPERATION

- Handle pulls out 3/8" to allow remote operation of the CSR from SCADA, as well as local/manual operation.
- When the CSR handle and shaft is pushed in, the remote operation of the CSR is disabled, and only local/manual operation remains possible.
- The CSR remains in the "Normal" position, vertical at 0 degrees.
- 2 N/O and 2 N/C lateral contacts are provided and will operate via the 3/8" axial movement (push/pull) of the CSR/SD handle shaft.
- Target flag agreement is always true regardless of remote or local mode.
- Electrical connections (15 amp, 600 volt) are provided for the 2 N/C and N/O contacts at the terminal block deck located at the rear of the CSR/SD. These can be used to provide customer status indication.

DECK	CONTACTS	PUSH	PULL	POS.			
				TRIP	N/C	N/O	CLOSE
				1	2 FROM	3	
					1	3	
AUX CONT	X 1 — I — I — I — I — X 3	X	X				
	X 2 — I — I — I — I — X 4	X	X				
	X 5 — I — I — I — I — X 7	X	X				
	X 6 — I — I — I — I — X 8	X	X				
1	1 2 — I — I — I — I — 1 3						X
	1 6 — I — I — I — I — 1 7						X
2	2 1 — I — I — I — I — 2 8			X			
	2 4 — I — I — I — I — 2 5			X			
3	3 1 — I — I — I — I — 3 2				X		
	3 5 — I — I — I — I — 3 6				X		
4	4 2 — I — I — I — I — 4 3					X	
	4 6 — I — I — I — I — 4 7					X	
5	5 1 — I — I — I — I — 5 2			X			
	5 5 — I — I — I — I — 5 6			X			

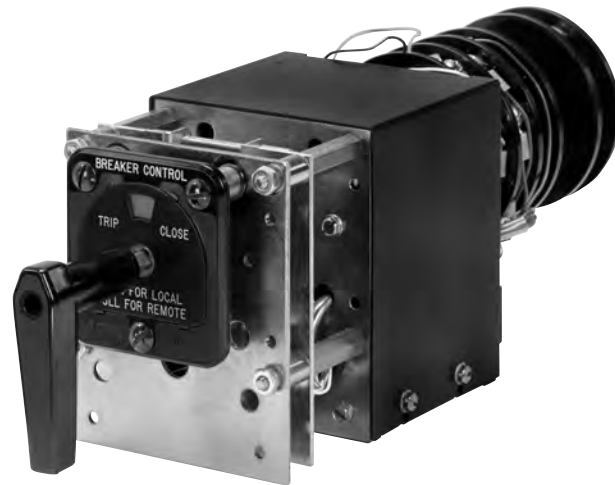
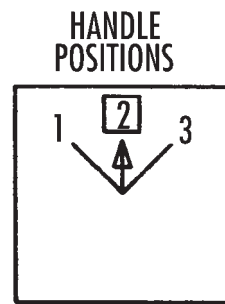

SPRING RETURN TO POSITION 2

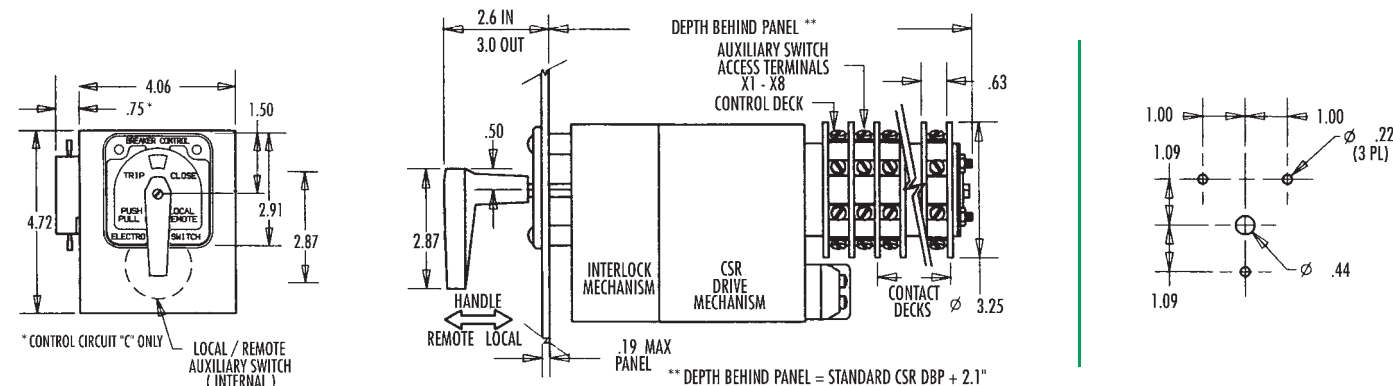



SCSR SERIAL CONTROL SWITCH RELAY

Automation That Keeps A Handle On System Protection And Control

The Series 24 Serial Control Switch Relay (SCSR) with Certified DNP 3.00 or Modbus expands the functionality of the field proven remotely operated Series 24 Breaker Control Switch.

An addressable network device, the SCSR provides Remote Trip Coil Monitoring, Sequence of Events (SOE) Reporting, System Battery Monitoring, and Self-Diagnostic Reporting, while maintaining traditional local control operability.

Features

- Construction and Contacting Based on the Field Proven CSR Device
- Breaker Position via LED, SCADA, Serial Comm & Mechanical Target
- Breaker Trip Coil(s) Integrity LED
- Serial Bus XMT/Rec LED
- Local/Remote Mode Control with LED Status Indication
- Manual Trip/Close Handle
- Programmable Dwell Time
- Monitor Up to Two Trip Coils

Cost-Saving Benefits

- Free up RTU Points
- Reduce Point to Point Wiring
- Simplify Testing for Easier Commissioning
- Minimize Training
- Eliminate Separate Devices
 - RTU
 - Interposing Relays for Breaker Control
 - Discrete Battery Monitors
 - Breaker Status Lamps
 - Local/Remote Control Switch
- Precise Sequence of Events Log with IRIG-B Input



Traditional CSR Installation

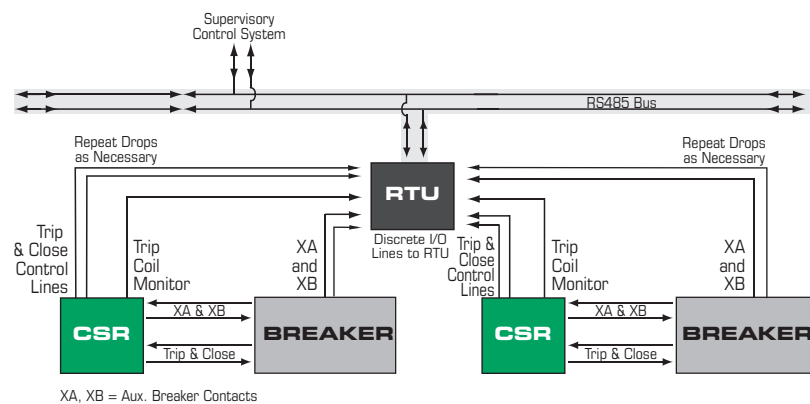

vs New Simplified SCSR Installation

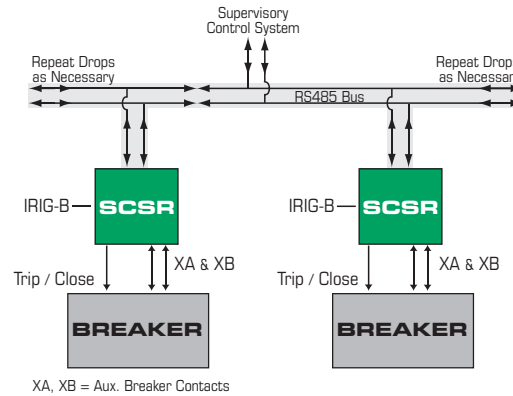

The SCSR installation provides cost savings associated with wiring (wiring errors), testing, and commissioning.

Other Serial Control Devices From Electroswitch



**Series 24
SLOR Serial
Lock-Out Relay
(page 49)**



**Series 31
STR Serial
Tagging Relay**



**CIM
Serial Control
Indicator Module
(page 73)**



SCSR SERIAL CONTROL SWITCH RELAY

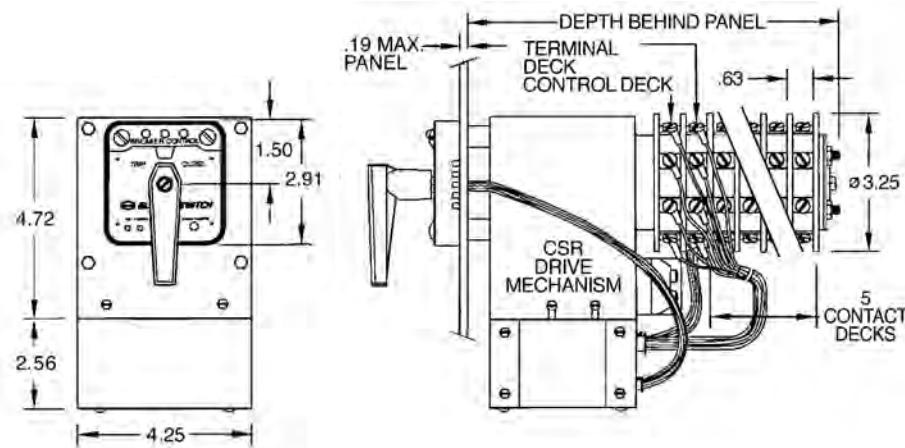

Nameplate – Typical Configuration

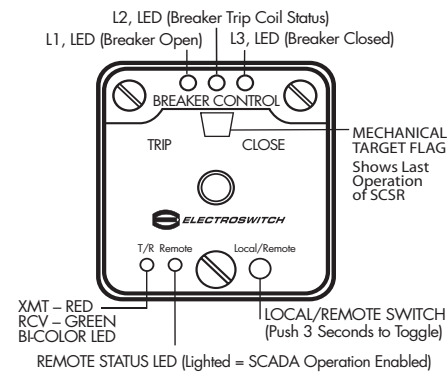

Specifications

Electrical
 Continuous Ratings: 30A–600V
 UL Interrupt Ratings: 20A–120VAC, 15A–240VAC, 6A–600VAC, 3A–125VDC, 1A–250VDC
 Overload Current (50 Ops): 95A–120VAC, 65A–240VAC, 35A–600VAC
 Making Ability for CB Coils: 95A–125VDC
 Contact Resistance: .01 Ohms Maximum

Electronic
 Baud Rate: 9600 Std, 1200, 4800, 19200 Selectable
 Transient Protection: Meets IEEE C37.90.1 and IEC 61000-4-4
 Signal Hold Time: 1 Sec. Standard, 1-3 Seconds Serially Selectable

Mechanical
 Sections: 1 to 6
 Poles: 1 to 12
 Contacts: Break-Before-Make (Non-Shorting); Make-Before-Break (Shorting)
 Standard and Slip Contacts Available
 Action: 45° Spring Return to Normal
 Mounting: Panel Mount, 3 Hole Mounting, 3/16" Max. Standard – Others Available
 Panel Thickness: 3/16" Max. Standard – Others Available
 Rotor Contacts: Silver Inlay Phosphor-bronze, Double-Wiping
 Stationary Contacts: Silver Plated, with Integral Screw Type Terminals
 Construction: Contacts Enclosed in Molded Phenolic Insulators

Operational and Burden Voltage Data

Coil	Rated Voltage	Voltage Range	Coil Circuit DC Ohms @ 25°C	Burden (amps) at Rated Voltage
C	48VDC	41-56VDC	4.83	9.9
D	125VDC	106-140VDC	18.96	6.6

Installation Connections (Rear View)

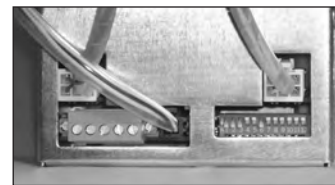
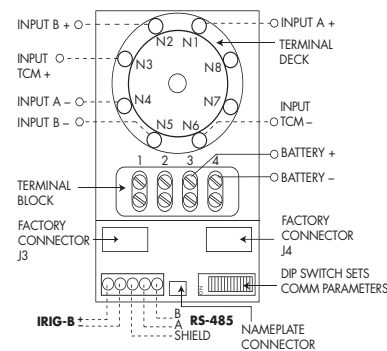

Contact Configuration

Flexible deck configuration offers multiple decks with two isolated contacts per deck; a total of twelve contacts each designed to handle full rated current.

NOTE: All features and configurations currently available on the CSR are available on the Serial Control SCSR.

Typical Breaker Input Connections

System Connections

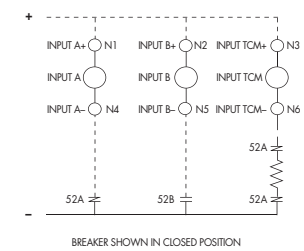

Use of Inputs

Input A controls the L3 (right) LED and sets DNP object 1 point 4. In a typical application, it is used to monitor a 52A contact.

Input B controls the L1 (left) LED and sets DNP object 1 point 3. In a typical application, it is used to monitor a 52B contact.

Input TCM controls the L2 (center) LED and sets DNP object 1 point 5. In a typical application, it is used as a trip coil monitor.

The inputs are polarity sensitive. Reverse polarity causes no damage, but input will not be sensed.

Consult Technical Bulletin ES-SCSR-1 for further information on DNP usage, or ES-SCSR-3 for Modbus.

Required Ordering Information

- Protocol: DNP 3.00 or Modbus
- Baud Rate: 9600 Std.
- Handle: Pistol Grip Std.
- Voltage: 125VDC or 48VDC
- Engraving
- Turn to Latch Option
- Single or Dual Trip Coil Monitoring
- Contact Configuration
- L1, L2, L3 (Replaceable LED Colors – Amber, Red, Green, Blue, White)
- Trip/Close Hold Time – Range 1-3 sec.; Standard Setting 1 Sec.



TD-CSR TIME DELAY CONTROL SWITCH RELAY

Breaker Control Switch Relay with Time Delay Trip and Close for Arc Flash Protection of Personnel

The Time Delay Control Switch Relay (TD-CSR) provides a means of protecting personnel from arc flash during local breaker operation. The time delay feature of the new TD-CSR expands the functionality of the field-proven CSR.

Integrated into the lighted nameplate package, two front panel-mounted push buttons provide the ability to manually initiate a time delayed breaker trip or close operation.

A flashing LED alerts the operator of either a pending trip or close operation, allowing adequate time to evacuate the arc flash area.

The TD-CSR is available with all of the features and options of the standard CSR. The lighted nameplate includes local LED indication, a remote SCADA contact alarm, and a single or dual trip coil monitoring option.



TD-CSR Lighted Nameplate Showing Delay Trip and Delay Close Push Buttons

Features

- Local Trip or Close with 10 Second Delay via Push Button
- Flashing LED to Indicate Pending Operation
- Pending Operation Easily Cancelled
- Visible LED and Trip/Close Flag Indication
- Four Second Hold Requirement Prevents Accidental Push Button Operation
- Optional Factory Programmable Delay Time
- Traditional Manual Trip and Close via Pistol Grip

Safety and Cost-Saving Benefits

- Provides Safe On-Site Breaker Operation While Keeping Personnel Outside The "Arc Flash Zone"
- Fits Into Existing Breaker Control Switch Mounting
- No Special Wiring Required
- Includes Features of the Standard CSR
- Intuitive Push Button Operation Simplifies Training Requirements
- Provides a Reliable, Cost-Effective Method for Arc Flash Hazard Protection

Other Arc Flash Control Devices From Electroswitch



3 Position Tagging Relay
(Page 68)

Position 1

Reclose Disabled

Position 2

Reclose Enabled

Position 3

Tagged, Relay Set to Instant Trip, Reclose Disabled — One Shot to Lockout



2 Position Tagging Relay
(Page 68)



TD-CSR TIME DELAY CONTROL SWITCH RELAY

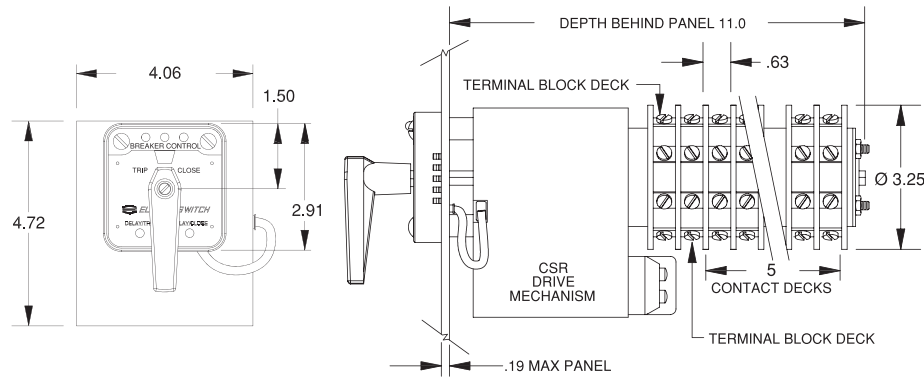

Nameplate – Typical Configuration

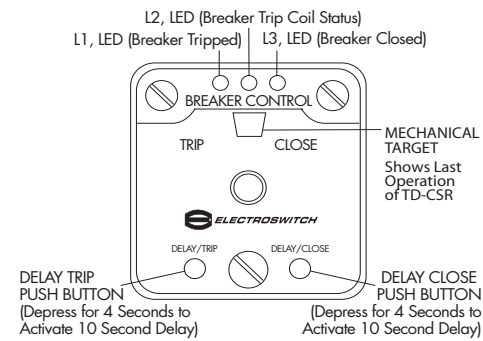

Specifications

Electrical

Continuous Ratings: 30A–600V
 UL Interrupt Ratings: 20A–120VAC, 15A–240VAC, 6A–600VAC, 3A–125VDC, 1A–250VDC
 Overload Current (50 Ops): 95A–120VAC, 65A–240VAC, 35A–600VAC
 Making Ability for CB Coils: 95A–125VDC
 Contact Resistance: .01 Ohms Maximum

Electronic

Transient Protection: Meets ANSI/IEEE C37.90.1
 Operation Hold Time: 1 Sec. Standard



Mechanical

Contacts: Break-Before-Make (Non-Shorting); Make-Before-Break (Shorting); Standard and Slip Contacts Available
 Action: 45° Spring Return
 Mounting: Panel Mount
 Panel Thickness: 3/16" Max. Standard – Others Available
 Rotor Contacts: Silver Overlay Phosphor-bronze, Double-Wiping
 Stationary Contacts: Silver Inlay Plated, with Integral Screw Type Terminals
 Construction: Contacts Enclosed in Molded Phenolic Insulation

Operational and Burden Voltage Data

Coil	Rated Voltage	Voltage Range	Coil Circuit DC Ohms @ 25°C (+/- 10%)	Burden (Amps) @ Rated Voltage (+/- 10%)
A	24VDC	21-28VDC	1.2	20.5
C	48VDC	41-56VDC	4.9	9.9
D	125VDC	106-140VDC	19	6.6
D	120VAC	106-140VAC	19	6.6
F	240VAC	216-264VAC	81	3.2
F	250VDC	212-280VDC	81	3.2

Typical Breaker Input Connections

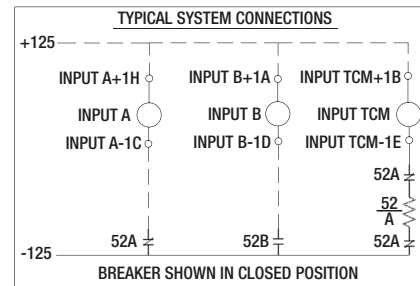

Use of Inputs

Input A controls the L3 (right) LED. In a typical application, it is used to monitor a 52A contact.

Input B controls the L1 (left) LED. In a typical application, it is used to monitor a 52B contact.

Input TCM controls the L2 (center) LED. In a typical application, it is used as a trip coil monitor.

The inputs are polarity sensitive. Reverse polarity causes no damage, but will not be sensed.

Contact Configuration

Flexible deck configuration offers multiple decks with two isolated contacts per deck; a total of twelve contacts each designed to handle full rated current.

NOTE: All features and configurations currently available on the CSR are available on the TD-CSR.

Consult factory for additional information.

Required Ordering Information

- Handle: Pistol Grip Std.
- Voltage: 125VDC or 48VDC
- Engraving
- Turn to Latch Option
- Single or Dual Trip Coil Monitoring
- Contact Configuration



SELECTOR SWITCH RELAYS

The Series 24 Selector Switch Relay (SSR) is an auxiliary relay that combines electrical and manual operation in a single unit for multiposition applications. Basically a unidirectional (CCW) stepping switch, the SSR can be used in any 2 to 8 position application. The SSR is ideally suited for tapswitch applications or any other multiposition application where simple or complicated contacting is used.

Note: The Series 24 SSR Class 1E utility products comply with the following Nuclear Standards: ANSI/IEEE C37.90, ANSI/IEEE C37.90.01, ANSI/IEEE C37.98, ANSI/IEEE C37.105, ANSI/IEEE 323, ANSI/IEEE 344, ANSI/ASME NQA-1.

The Series 24 Selector Switch Relay

- HIGH QUALITY**
 - Designed and manufactured to the highest standards in the industry
 - Qualified to UL, CSA
- VERSATILITY**
 - 2 to 8 unidirectional multiposition
 - Up to 10 decks and 20 poles
 - Available for electric or manual operation
 - 3 switch circuits - One to match your application needs
- SERVICE**
 - The Electroswitch team of Customer Service and Applications Professionals stand behind every Electroswitch product. Let us put over 50 years of know-how to work for you!



SERIES 24 SSR RELAYS ORDERING INFORMATION

(Consult Factory)

PANEL MOUNT

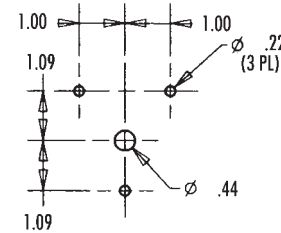
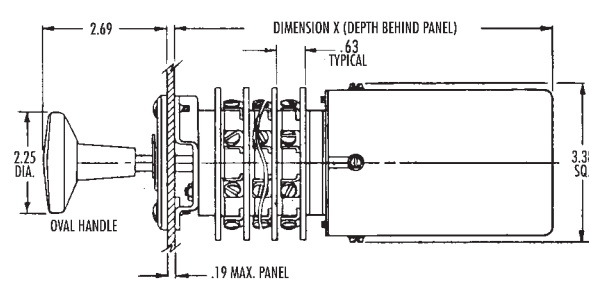
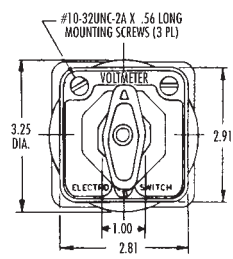

DEPTH BEHIND PANEL

NO. OF DECKS	DIM. X
3	8.97
5	10.22
8	12.09
10	13.34

SHELF MOUNT

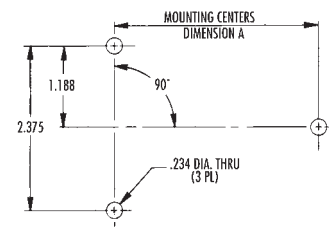
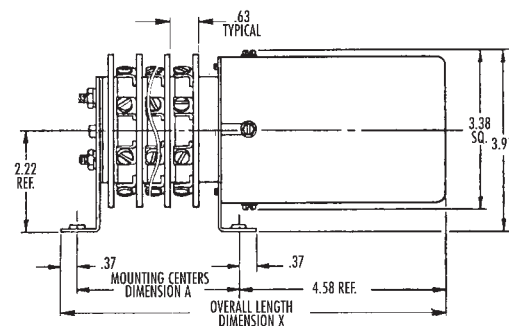
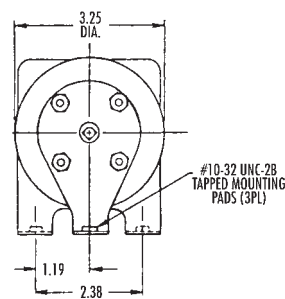

DIMENSIONS

NO. OF DECKS	DIM. A	DIM. X
3	4.134	9.08
5	5.384	10.33
8	7.259	12.21
10	8.509	13.46



LATCHING SWITCH RELAYS

The electrical power industry has a great variety of requirements for latching type auxiliary relays to provide maintained contacts – both N/C and N/O. Often, manually operated switches are used in conjunction with traditional relays to provide the “maintained” function. However, traditional protective relays have limitations as to the number of contacts available and their ability to withstand seismic vibration. Traditional auxiliary relays used in conjunction with the protective relays also exhibit these limitations.

The LSR Latching Switch Relay was developed to meet these requirements. It is a two position rotary action Latching Switch Relay that provides control of up to 20 N/O and 20 N/C contacts in a single device. It is a manually or remotely operated unit used for a variety of applications; latching relay, reclosing relay, programming relay, and local/remote switch that is SCADA compatible.

- Series 24 LSR now available with lighted nameplate. See page 12 for Lighted Nameplate information.

NOTE: The Series 24 and 31 LSR Class 1E utility products comply with the following Nuclear Standards: ANSI/IEEE C37.90, ANSI/IEEE C37.90.1, ANSI/IEEE C37.98, ANSI/IEEE C37.105, ANSI/IEEE 323, ANSI/IEEE 344, ANSI/ASME NQA -1.

Series 24 and 31 Latching Switch Relays

- | | |
|--------------|--|
| HIGH QUALITY | <ul style="list-style-type: none"> • Designed and manufactured to the highest standards in the industry • Qualified to UL, CSA, ANSI/IEEE |
| VERSATILITY | <ul style="list-style-type: none"> • 2 Size options - Series 24 and Series 31 • Up to 20 N/O and 20 N/C contacts • Electric or manual operation • Control circuits • Available without handle for remote only operation |
| SAFETY | <ul style="list-style-type: none"> • 1E Nuclear qualified |
| AVAILABILITY | <ul style="list-style-type: none"> • Many Series 24/31 LSRs are available from stock for immediate delivery |
| SERVICE | <ul style="list-style-type: none"> • The Electroswitch team of Customer Service and Applications Professionals stand behind every Electroswitch product. Let us put over 50 years of know-how to work for you! |

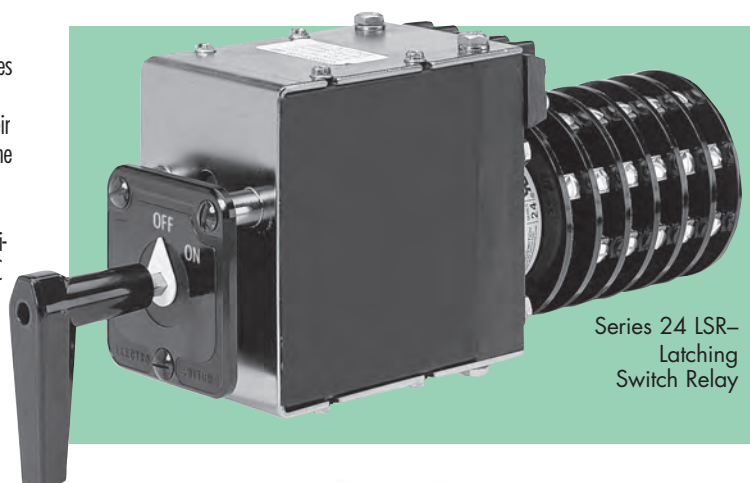

Series 24 LSR-Latching Switch Relay

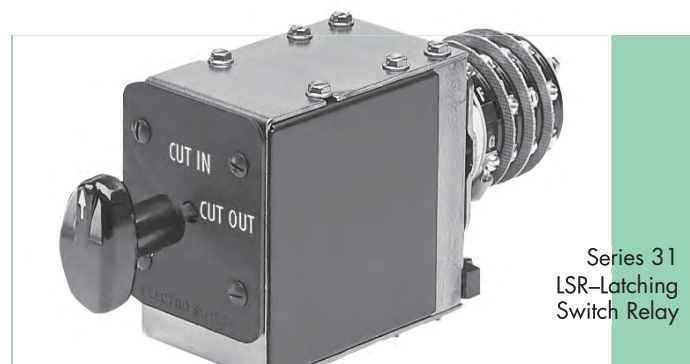

Series 31 LSR-Latching Switch Relay

NOW AVAILABLE!
The New Serial Communication LSR
 (DNP 3.0 or Modbus)

For more information, visit:
www.electroswitch.com
 or call: **781-335-5200**

Contact Deck Arrangement

The blade and terminal configuration enables the use of multiple contacts in the same deck, and simple stacking procedures enable the fabrication of many independent contacts in one relay. Specifically, two N/O contacts and two N/C contacts are provided in each deck, and ten decks can be stacked, resulting in a relay with up to forty contacts. This deck arrangement is illustrated in Fig 1.

The contacts operate reliably, using every contact and terminal illustrated. For good practice, however, it is suggested that polarized voltages should not be used on adjacent contacts. This is because of the remote possibility of flashover during transition between adjacent contacts — especially at the higher DC ratings, or in highly inductive circuits.

The illustration of the basic deck LSR layout is for the first deck. For multideck units the second digit of the terminal number is the same as the deck number.

As an example: Terminal 82 is in the eighth deck, in line under terminal 12 and is a N/O contact used together with terminal 84.

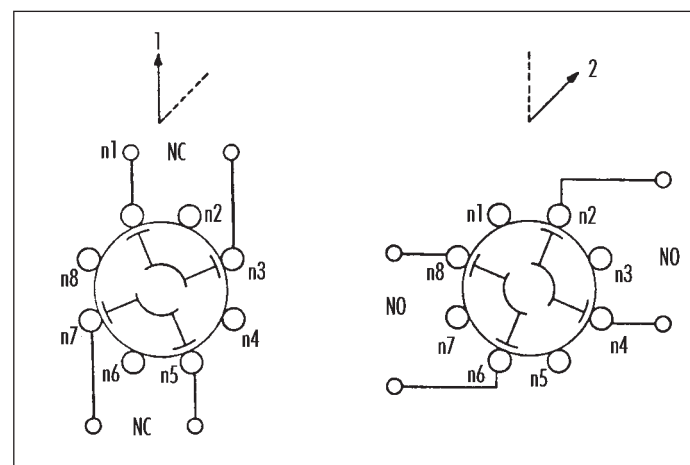

FIG 1.



LATCHING SWITCH RELAYS

Contact Ratings

The LSR Latching Switch Relay has been tested to many different circuit conditions. The interrupting ratings are based on 10,000 operations of life, using suddenly applied and removed rated voltage, with no extensive burning of contacts. Inductive ratings are based on tests using standard inductance $L = 0.04$ for DC and $\cos \theta = 0.4$ for AC. The Interrupting Rating column headed "double contacts" means two contacts in series. Short-time and continuous ratings are based on temperature rise in contact members and supporting parts not exceeding 50°C above ambient.

Contact Ratings for Series 24 LSR Latching Switch Relay

CONTACT CIRCUIT VOLTS	INTERRUPTIVE RATING (AMPS)				SHORT TIME RATING* (AMPS)	CONTINUOUS RATING (AMPS)
	RESISTIVE		INDUCTIVE			
	SINGLE CONTACT	DOUBLE CONTACT	SINGLE CONTACT	DOUBLE CONTACT		
125VDC	5	10	2	5	60	30
250VDC	3	5	1	2	60	30
120VAC	20	30	20	30	60	30
240VAC	15	20	15	20	60	30
480VAC	7.5	15	10	10	60	30
600VAC	7.5	7.5	10	10	60	30

Contact Ratings for Series 31 LSR Latching Switch Relay

CONTACT CIRCUIT VOLTS	INTERRUPTIVE RATING (AMPS)		SHORT TIME RATING* (AMPS)	CONTINUOUS RATING (AMPS)
	RESISTIVE	INDUCTIVE		
	SINGLE CONTACT	SINGLE CONTACT		
12VDC	5	5	25	15A
24VDC	5	5	25	15A
48VDC	1	1	25	15A
125VDC	1	1	25	15A
120VAC	10	10	25	15A
240VAC	5	5	25	15A
600VAC	3	1	25	15A

* Short time current is for one minute

Contact Charts

The contact deck arrangements show construction of the relay and are shown as information for the user. Traditional contact charts are more appropriate, as shown to the right.

DECKS	CONTACTS	POS.	
		1	2
1	11 ○ — — — ○ 13	✓	✓
	12 ○ — — — ○ 14	✓	✓
	15 ○ — — — ○ 17	✓	✓
	16 ○ — — — ○ 18	✓	✓
	21 ○ — — — ○ 23	✓	✓
10	81 ○ — — — ○ 83	✓	✓
	82 ○ — — — ○ 84	✓	✓
	85 ○ — — — ○ 87	✓	✓
	86 ○ — — — ○ 88	✓	✓

Coil Voltage Data

COIL	NOMINAL VOLTAGE	VOLTAGE RANGE
C	48VDC	38-56VDC
D	125VDC	100-140VDC
F	250VDC	200-280VDC

Coil Burden Data

COIL	COIL CIRCUIT VOLTS	SERIES 24		SERIES 31	
		COIL CIRCUIT DC OHMS @ 20° C	BURDEN (AMPS) @ RATED VOLTAGE	COIL CIRCUIT DC OHMS @ 20° C	BURDEN (AMPS) @ RATED VOLTAGE
C	48VDC	4.83	9.9	4.91	9.7
D	125VDC	18.96	6.6	30.48	4.1
F	250VDC	81.14	3.1	109.0	2.3

OPTIONS

Low Level Control

(Recommended For Use with All Microprocessor-Based Devices)

The low level command contacts (S1 and S2) close on an interposing relay coil (k1) and the rotary solenoid coil (LSR) is controlled by the relay contact (K1). S1 and S2 can be LSR contacts rated less than 1 ampere. The circuit is interrupted by the internal LSR contacts, so S1 and S2 need to "make" the low level circuit only.

To command the LSR to position 2, S1 is closed momentarily (100 milliseconds minimum). This completes a circuit to the rotary solenoid LSR and the device indexes to position 2 and latches. When this occurs, LSR/1 contact opens, interrupting the LSR solenoid circuit. The LSR solenoid resets itself and awaits the next command.

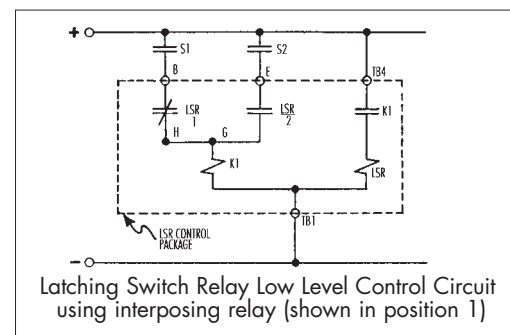

Direct Control Method

The command contacts (S1 and S2) close directly on the full LSR rotary solenoid coil current, so the burden data of this solenoid should be considered in the choice of these control contacts. The internal LSR contacts interrupt the solenoid current however, so S1 and S2 need to "make" the circuit only.

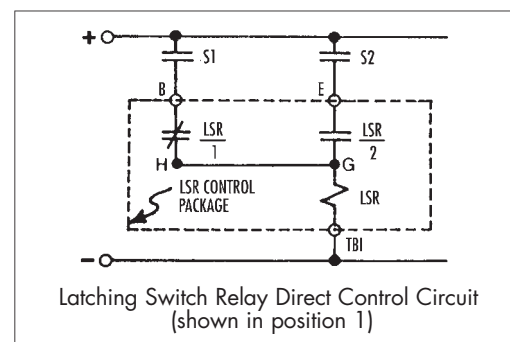



LATCHING SWITCH RELAYS

Series 24 LSR—Panel Mount

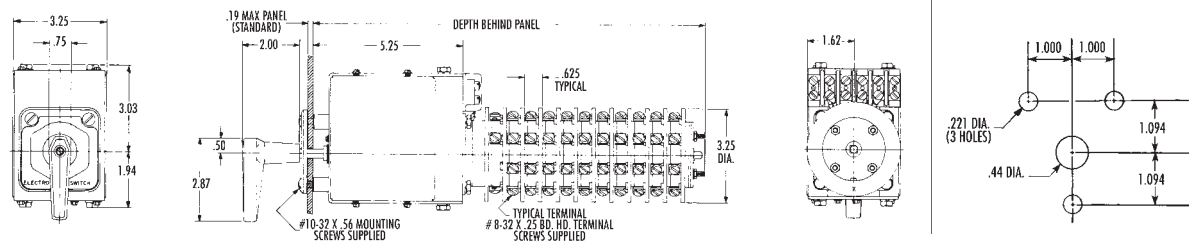

DEPTH BEHIND PANEL

NO. OF DECKS	DEPTH (IN)
3	9.06
5	10.56
8	12.19
10	13.56

Series 24 LSR—Shelf Mount

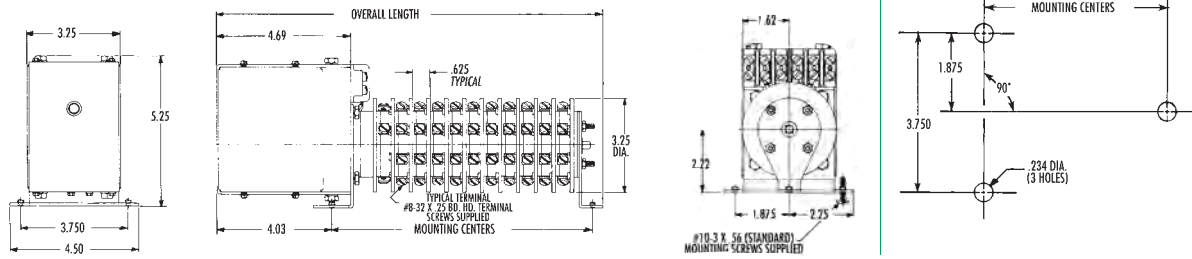

DIMENSIONS

NO. OF DECKS	MTG. CTRS.	LENGTH
3	4.719	9.12
5	5.969	10.37
8	7.844	12.25
10	9.094	13.50

Series 31 LSR—Panel Mount

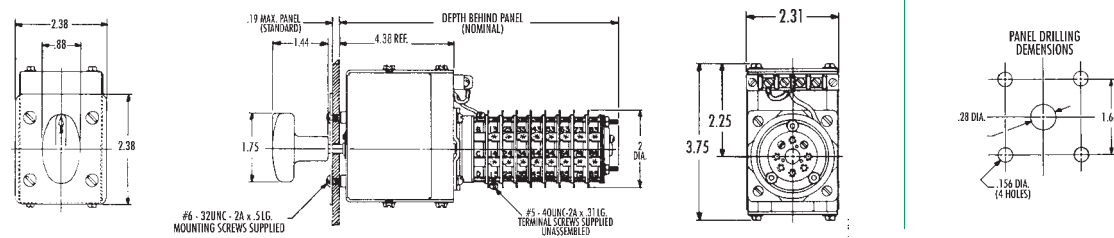

DEPTH BEHIND PANEL

NO. OF DECKS	DEPTH (IN)
3	6.7
6	7.8
8	8.6

Series 31 LSR—Shelf Mount

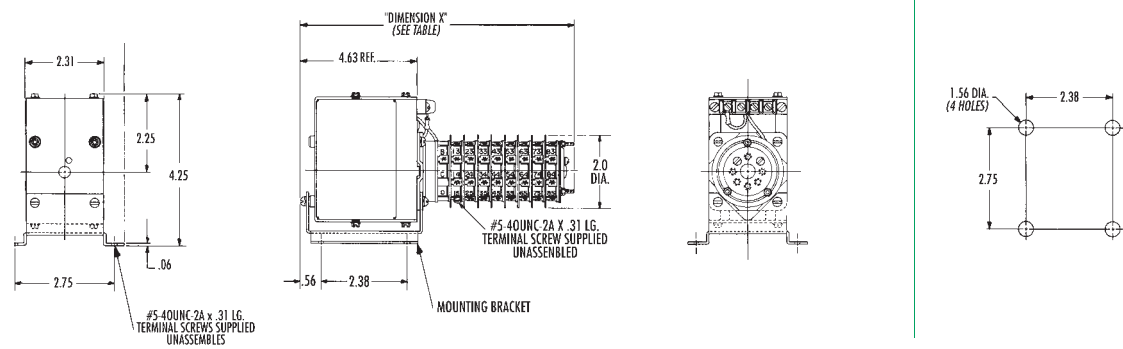

DIMENSIONS

NO. OF DECKS	DIM. X
3	6.9
6	8.1
8	8.9

LSR ORDERING INFORMATION 110VAC operating voltages available on certain applications. Contact factory for further information.

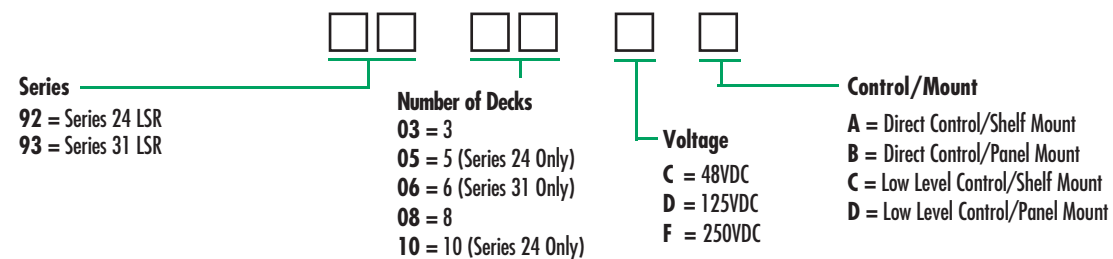



Personnel Protection Through SCADA Control of NESC "Tag-Out" Function



Features

- Available in Two or Three Position Versions
- Remote or Manual Operation
- Bidirectional Operation
- 60mSec Maximum Response Time
- Orange "Warning" Hot Line Tag
- No. of Decks
 - Series 31 Two Position — Up to 8
 - Three Position — Up to 6
 - Series 24 — Up to 10
- Contacts: 2 N/O, 2 N/C per Deck

Applications

- For Distribution Automation and Safety Tagging
- Expand SCADA Beyond Sub-Stations to Distribution Feeders
- Automate Power Distribution
- Remote Reclosure Cut-Off
- Enhance Breaker Control Schemes
- Improve Service Reliability

Electroswitch Tagging Relays allow remote or manual circuit breaker operation for automated power distribution. They feature an eye-catching orange "Warning" hot line tag ensuring personnel safety in compliance with utility requirements.

Designed with multiple contacts housed in a compact unit, they provide an ideal solution to tagging requirements in both new and existing systems. The three position version may be operated to "Closed", "Open" or "Tagged" position manually, electrically or remotely from SCADA. The two position relay offers the same operations with "Normal" and "Tagged" positions. For custom tags and engraving, contact the factory.

Major applications include expanded SCADA systems beyond substations to distribution feeders; automated reclosure cut-off; and optimal breaker control schemes with improved service reliability.

The design and quality construction of these relays are based on an Electroswitch track record spanning five decades of supplying reliable switches, relays and related control devices to the utility industry.

Note: The Series 24 and 31 two position Tagging Relays are Class 1E utility products and comply with the following Nuclear Standards: ANSI/IEEE C37.90, ANSI/IEEE C37.90.01, ANSI/IEEE C37.98, ANSI/IEEE C37.105, ANSI/IEEE 323, ANSI/IEEE 344, ANSI/ASME NQA-1.

Specifications

- Available for Both Low Level and Direct Control Applications
- Low Level Control Recommended for All Microprocessor Applications
- Contact Ratings: (Interrupt)
 - Series 31: 10A-120VAC, 1A-125VDC
 - Series 24: 20A-120VAC, 3A-125VDC
- Operating Voltages: 48VDC, 125VDC Standard, Others Available
- Response Time: 60mSec maximum
- Coil Burden:
 - Series 31 Two Position: 9.7A @ 48V; 4.1A @ 125V
 - Series 31 Three Position: 13.4A @ 48V; 5.3A @ 125V
 - Series 24 Two Position: 9.9A @ 48V; 6.6A @ 125V
- Decks: Two Position:
 - Up to eight (Series 31)
 - Up to 10 (Series 24)
 - Three Position:
 - Up to six

ORDERING INFORMATION

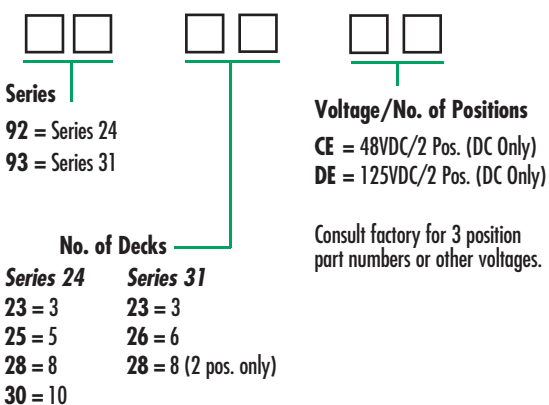



TAGGING RELAYS

SERIES 24 - TWO POSITION

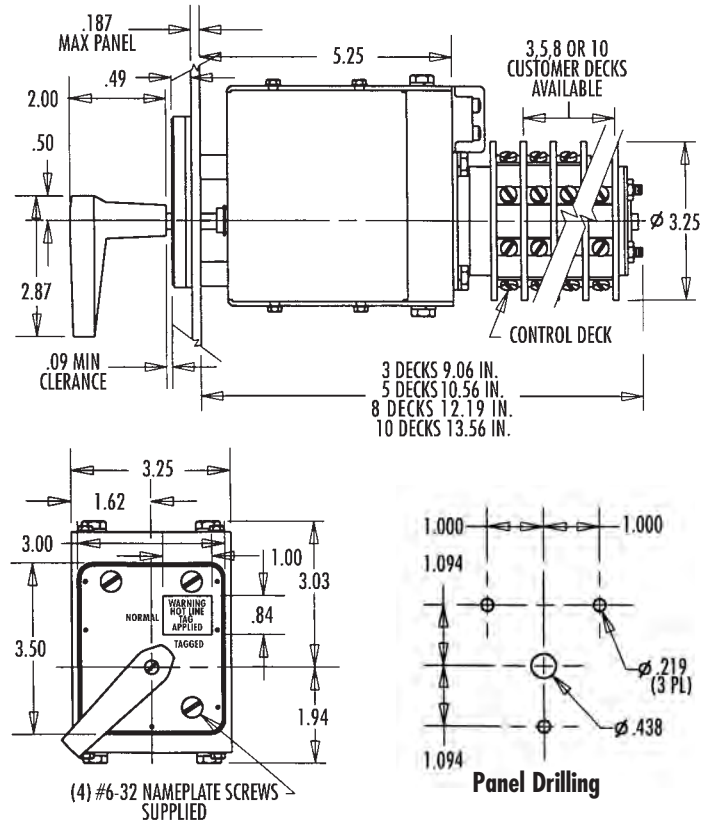

SERIES 31 - TWO POSITION

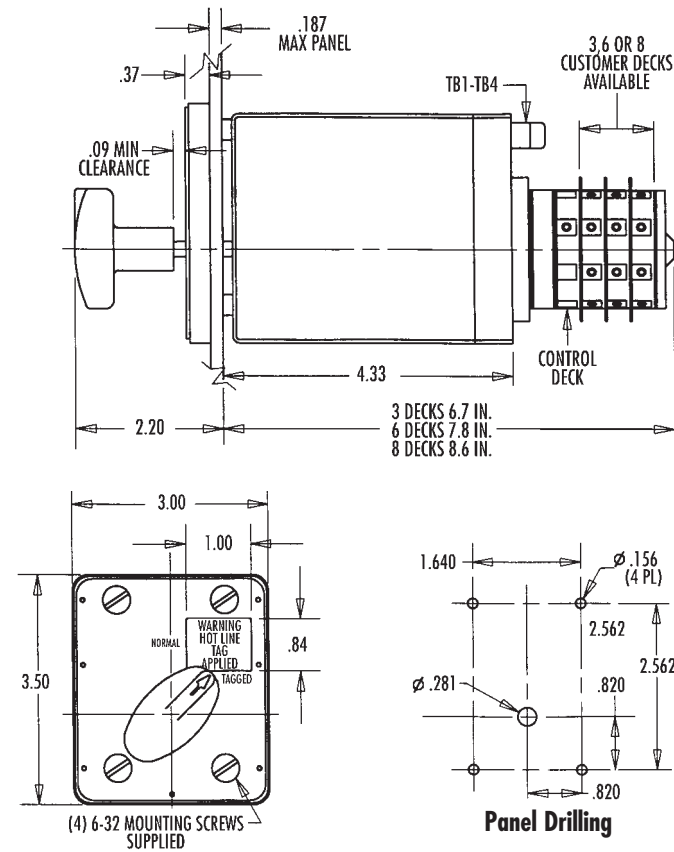

SERIES 24 TWO POSITION CONTROL VOLTAGES			
CONTROL VOLTAGE	48 VDC	125 VAC	120 VAC
COIL BURDEN	9.9 AMP	6.6 AMP	6.3 AMP
RESPONSE TIME	25-60 msec		

SERIES 31 TWO POSITION CONTROL VOLTAGES			
CONTROL VOLTAGE	48 VDC	125 VAC	120 VAC
COIL BURDEN	9.7 AMP	4.1 AMP	3.9 AMP
RESPONSE TIME	15-35 msec		

DECK	CONTACTS	POS.	
		NORMAL	TAGGED
1	11-12-13	✓	
	12-13-14		✓
	15-16-17	✓	
	16-17-18		✓

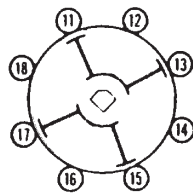

Additional Customer Decks Same As Deck 1 Except Terminal Numbers.
(Deck 2: 21 to 28, Deck 3: 31 to 38, Etc)

LOW LEVEL CONTROL

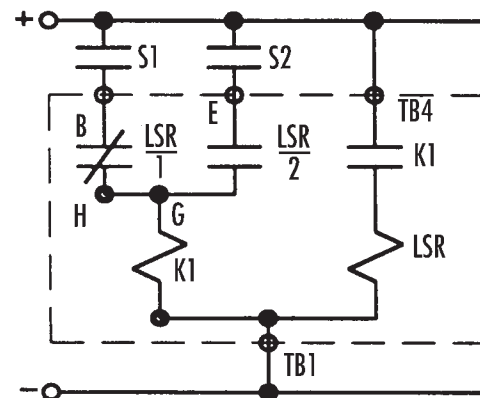



ATR Annunciator Target Relays

ATR Annunciator Target Relay Improves Trip Indication with a Highly Visible LED, Fast Response Time, Small Panel Footprint, and Standard Three Hole Mounting Configuration

The Electroswitch Series ATR is a solid state Annunciator Target Relay designed for use in a variety of utility applications. It provides a highly visible LED indication of a Trip operation and activates other equipment within the system such as alarms, LORs, and other relay devices.

How it Works

The ATR accepts a 37-140VDC Trip input signal from a variety of devices. When a Trip signal is received, the ATR performs two basic functions. First, it illuminates a bright LED indicating that a Trip signal has indeed been received. Second, it closes two normally open auxiliary contacts rated at 2 Amps @ 125VDC continuous (8A for 1 second). These contacts can be used to activate lock-out relays or other auxiliary devices. An input signal, once received, is latched in memory and is maintained even through power outages until manually reset.

The target LED is highly visible even when viewed from extreme angles. It is designed for long life (>100,000 hours) and available in a variety of colors (amber, red, blue, green, or white) to help identify different functions or circuits.

Because the ATR is a solid state device it features a much shorter response time. It is less sensitive to shock and vibration than electromechanical devices and is also dramatically smaller. A traditional three hole mount configuration making installation simpler than alternative designs.

Theory of Operation

- See www.electroswitch.com

Benefits

- Highly Visible LED Target - Even at Extreme Angles
- Provides Clear Indication of a Trip
- Faster Response Time
- Saves Panel Space
- Traditional Three Hole Mount Configuration
- Reduced Purchase and Installation Cost
- Easy to Use...No Special Operator Training



Make The Electroswitch ATR with Lighted Target Part of Your Trip Detection and Protection Scheme

Features

- Bright LED is Clearly Visible from all Viewing Angles in Front of the Panel
- Long Life LED (> 100,000 Hours), Available in Choice of Colors to Identify Different Functions or Circuits - Amber, Red, Blue, Green, or White - Field Replaceable From the Front
- Save Valuable Panel Space. The Entire Package is less than 3.0" Square about 0.5" High
- Low Power Consumption - 125VDC @ 14 mA (37 to 140VDC operation range)
- 2 Form "A" Auxiliary Contacts Rated 2 Amp @ 125VDC Continuous and 12A for 1 Second
- User Definable Trip Response Time from 0.001 to 1.875 Seconds
- Trip Inputs Validated with High Reliability Digital Algorithm
- Operating Temperature: -20°C to +55°C
- Traditional Three hole Mounting Arrangement
- Approvals - ANSI/IEEE C37.90.1-1995, ANSI/IEEE C37.90.2-1995
- UL, CSA and CE Pending
- Time Delay Option Available
- Dual Change of State Available

Ordering Information

Model Number	Description
686-100A	Voltage Sensing Annunciated Target Relay with seal in of auxiliary contacts
686-110A	Voltage Sensing Annunciated Target Relay without seal in of auxiliary contacts

Consult factory for other models.

FRONT LED - INDICATES ATR IS TRIPPED
OUTPUTS ARE "ON" WHEN LIGHTED

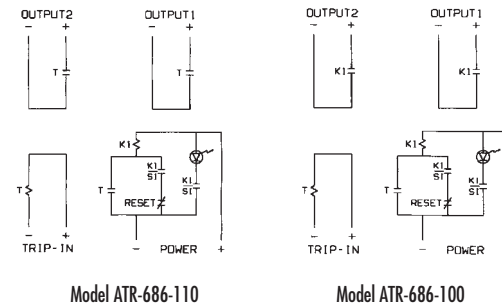
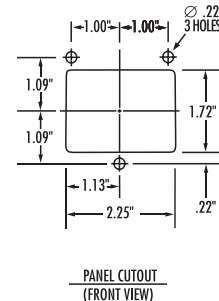
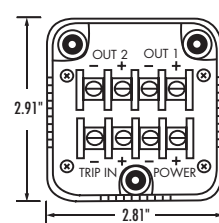
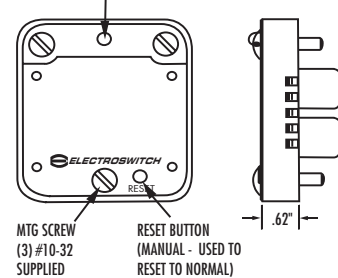

WIRING SCHEMATICS



**NEW
PRODUCT**

TCM TRIP COIL MONITOR

Trip Coil Monitor with Local LED and SCADA Alarm Provides Continuous Monitoring of the Breaker Trip Coil

The Electroswitch Trip Coil Monitor (TCM) is a convenient panel mounted relay that utilizes LEDs for visual indication and an added SCADA alarm feature.

The TCM provides continuous monitoring of the Breaker Trip Coil as well as the breaker's 52b auxiliary contacts. The TCM eliminates nuisance alarms via a built in time delay circuit. This provides for a reliable SCADA alarm and local indication when either the trip coil opens or the breaker doesn't complete its trip operation.

The TCM panel mounted package also has a self-monitoring feature providing both visual and SCADA alarm indication if there is a loss of voltage.



Features

- LED Indication of Open Trip Coils or Breaker Failure to Trip
- Dual Trip Coil Monitoring Option Available
- SCADA Indication of Open Trip Coil, Loss of Voltage or Failure of the Breaker to Trip
- Standard Alarm Time Delay
- Replaceable, Industry Standard LED
- Convenient Easy to Wire Design
- Standard TCM Covers 48 - 125 VDC Applications

Benefits

- Continuous Monitoring of Trip Coil Continuity
- Built in Delay Feature Eliminates Nuisance Alarms
- Solid State Design Prevents False Alarms Due to Magnetic Field Interference
- Minimal Behind Panel Space Required
- Extended Voltage Capability to Minimize Inventory and Reduce Potential Installation Errors
- Eliminates Need for Loss of Voltage Alarm

Specifications

Operating Voltage Range 37 – 140 VDC
 Scada Output Contact Rating 100mA MAX
 Operating Temperature Range -20C to +55C
 Standard Alarm Time Delay 400 millisecond
 Meets ANSI/IEEE 37.90 and ANSI/IEEE 37.90.1

Ordering Information

LED Color [Red Standard] Green, Blue, White, Amber Options
 SCADA Contact N/C [Standard] N/O Option Available
 Single Trip Coil Monitoring [Standard] Dual Trip Option Avail.
 Special Engraving if Required [Standard as Shown]

Consult Factory for Additional Information

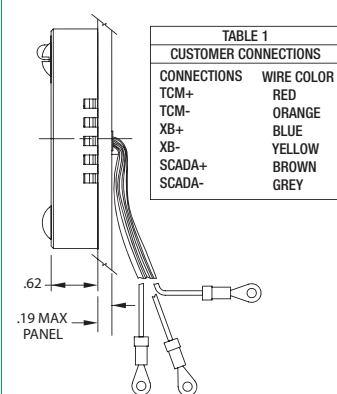
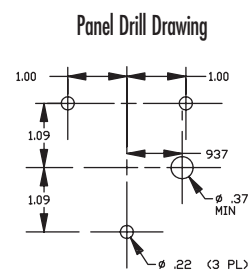
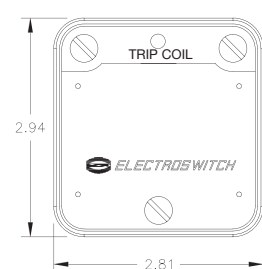
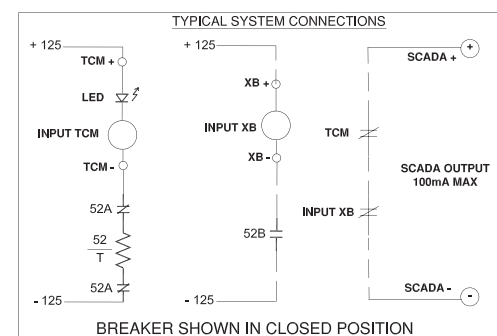

TABLE 1 CUSTOMER CONNECTIONS	
CONNECTIONS	WIRE COLOR
TCM+	RED
TCM-	ORANGE
XB+	BLUE
XB-	YELLOW
SCADA+	BROWN
SCADA-	GREY





Now with Serial Communications and Event Logging

CIM CONTROL INDICATOR MODULE

Features

- Modbus or DNP 3.0 Communications Protocol with event logging or Parallel SCADA Interface
- Bright LED Status Indicators with 100,000 Hour Operating Life (Red - Green - Amber)
- Compatible with Other Protective Equipment (Electro-Mechanical or Electronic)
- Small Footprint - Less than 13 sq. in. of Panel Space
- Available in Horizontal or Vertical Configuration

Applications

The Control Indicator Module (CIM) is designed as a universal substation automation solution by combining multiple control and monitoring functions into a single space-saving, cost-effective unit.

The CIM allows automation while maintaining a manual fail-safe switch. It is designed to monitor and controls up to two breakers and can monitor three trip coils. By incorporating a CIM into a new or existing system, functions of several individual devices (including reclosing and SCADA control, and status monitoring devices) can be combined into one smaller, more compact, cost-effective device.

The CIM provides visual status indication through LEDs located on the front panel, as well as backup, failsafe manual switch control.

Two Ways to

Control Breaker Operations (Trip/Close)

- From Integral Manual Breaker Control Switch
- Remotely via Serial or Parallel Interface

Monitor

- Status of Breaker (Tripped/Closed)
- Reclose Status (Enable/Disable)
- Continuity of Trip Coil (Open or Intact)
- SCADA Status (Enable/Disable)
- Trip Source (Manual, Protective Relay or SCADA)
- Remotely Access History of Recent Events (Serial Interface Only)

Control Reclose Operation (Enable/Disable)

- Local Manual Switch
- Remotely via SCADA

Control SCADA Operation (Enable/Disable)

- Local Manual Switch

CIM OPERATIONAL DESCRIPTION

The CIM is a Breaker Control Switch with expanded functionality that provides remote/local breaker control (trip/close), enable/disable Recloser control, and Breaker Trip Coil monitoring. The unit contains a serial or parallel SCADA interface for remote control and monitoring functions.

The CIM will control and monitor three different types of circuit breaker arrangements: a single trip coil, a dual trip coil, and a circuit switcher or ganged single pole breakers with single trip coils. All controls, indicators, and electronics are contained in a compact modular enclosure that can be horizontally or vertically panel mounted.



Control Functions: The CIM can trip and close a circuit breaker two different ways:

1. from a manual Breaker Control Switch mounted on the front panel
2. from SCADA

The CIM unit can also control a local automatic Reclose Relay (79) operation three different ways:

1. manual enable or disable switch
2. remote enable or disable from SCADA
3. manual trip disables Reclose

SCADA Functions: The CIM units contains either a RS-485 interface with DNP 3.0 or Modbus communications protocol or a simple 8 bit parallel interface. The interface is controlled by the SCADA enable/disable switch on the front panel of the CIM.

Serial Interface

Via the Serial Link the user can:

- Trip one or two isolated circuit breakers
- Close the circuit breaker
- Enable and Disable Reclose
- Monitor one, two or three trip coils for integrity
- Read the status of the CIM and circuit breaker
- Recall recent events and the time at which they occurred

Eight Bit Parallel Interface

There are three control signals, a single trip signal and two close signals.

The Trip Signal:

- "TR" signals the circuit breaker to immediately trip.

The Close Signals:

- "NC" signals the circuit breaker for a Normal Close with Reclose enabled for the next trip cycle.
- "TC" signals the circuit breaker for a Test Close. The breaker would immediately close. However Reclose would be blocked for the next trip cycle. (A "NC" signal would be required to reenable Reclose after a "TC" or Test Close.)

There are five monitor functions:

- "XA" monitors the "A" contact on the circuit breaker
- "XB" monitors the "B" contact on the circuit breaker
- "XRC" monitors the status of the Reclose function
- "XTM" monitors the status of the trip coil(s)
- "XSCADA" monitors the status of SCADA (Enabled/Disabled)



CONSTRUCTION DETAILS

SERIES 24 AND 31 DETENT-ACTION SWITCHES

Electroswitch Detent Switches

Electroswitch Detent Switches are a heavy-duty design that is very versatile and enables standard units to satisfy a great variety of complex switching applications. They are modular in that several subassemblies are stacked together to form a rigid rugged device. Figure 1 shows a cut-away view exposing the basic components.

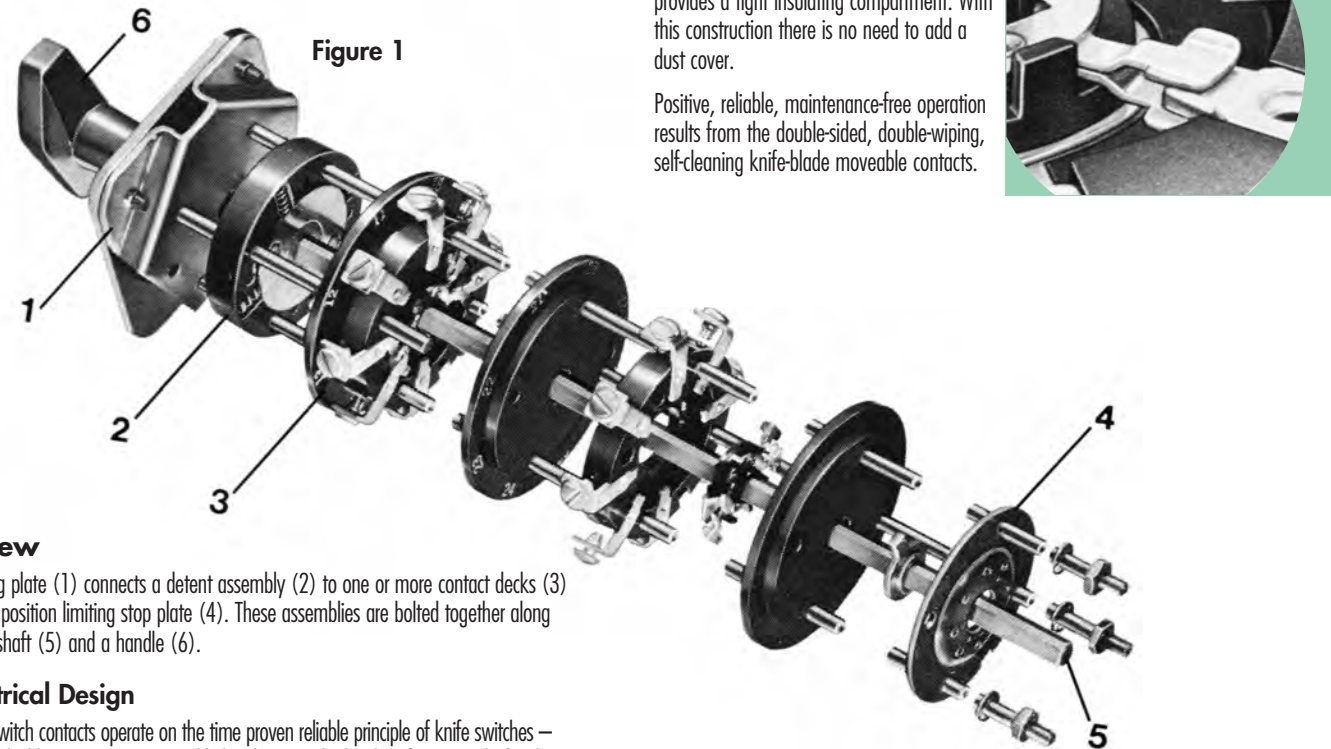

Figure 1

Overview

The mounting plate (1) connects a detent assembly (2) to one or more contact decks (3) and finally a position limiting stop plate (4). These assemblies are bolted together along with a steel shaft (5) and a handle (6).

The Electrical Design

The Detent Switch contacts operate on the time proven reliable principle of knife switches — double-sided, double-wiping, spring-wiper blades closing on both sides of a terminal. This design is shock-proof and virtually bounce-proof. Figure 2 shows a typical contacting arrangement.

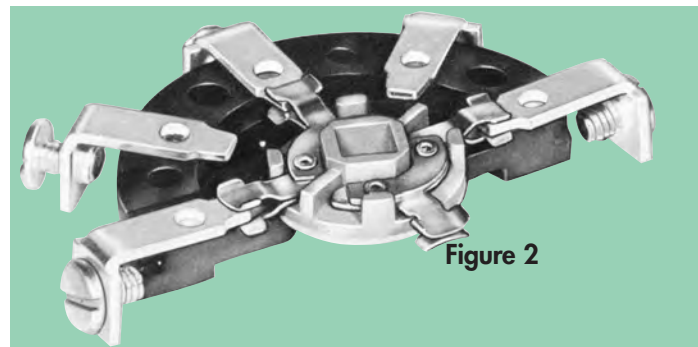

Figure 2

The Detent Assembly

The detent assembly contains a specially designed star wheel and up to four spring-loaded ball bearings providing snappy positive indexing. Spring return switches use a coil spring in place of the star wheel/spring/ball bearing arrangement.

The Pull-to-Lock Mechanism

Control switches generally have positions both 45° left and right of the normal vertical position. The handle spring-returns to the normal position. The pull-to-lock mechanism enables an operator to turn the handle beyond the left (normally TRIP) position to the 90° location, pull out the handle and thereby lock the switch into this position. This precludes the possibility of someone inadvertently closing a circuit-breaker when it is desired that it stay in the tripped position.

The Contact Deck Assembly

The electrical parts are contained within sturdy phenolic moldings that provide individual insulated compartments where all switching takes place.

An insulating barrier completes the contact deck assembly. The barrier not only separates one contact assembly from another but also provides a tight insulating compartment. With this construction there is no need to add a dust cover.

Positive, reliable, maintenance-free operation results from the double-sided, double-wiping, self-cleaning knife-blade moveable contacts.



The barrier next to the stationary terminals is clearly marked with numerals for Series 24 and 31 that correspond with the wiring diagrams.

Terminal screws secure the external wiring to the terminals.



Jumpering may be done right on the switch providing a simple and neat arrangement. Silver plated brass strap jumpers are available for adjacent contacts—either between adjacent contacts on the same deck or the same terminal location on adjacent decks. Wire and lug jumpers are also available. Jumpers are already supplied assembled on the typical instrument switches, illustrated in this catalog, simplifying field wiring. All you need to do is connect the instrument leads and the line wires.

The Stop Plate

The steel stop plate assembly includes a steel stop arm that is connected to the shaft and a steel stop plate that contains tapped holes. Stop screws are inserted in the field to limit the positions to the number and location desired. This externally adjustable position limiting feature allows the use of standard switches for many customized applications. The limit screws are supplied assembled for typical instrument switches.



CONSTRUCTION DETAILS

SERIES 101 SNAP-ACTION SWITCHES

Snap Action Switches

Snap Action Switches use a design that enables them to combine a small number of basic parts to satisfy a wide variety of requirements for selector and control switching of power circuits. Standard switches built with this design for 15-, 40-, 60-, and 200-ampere capacities are listed in this catalog. However, the cataloged units merely indicate switching possibilities; we will gladly recommend other combinations, based on our experience, for specific requirements.

Stationary Contacts

Non-shorting (break-before-make) contacts are standard in all the ratings and circuits shown in this catalog.



Shorting (make-before-break) contacts, required in some special circuits, are available on order.

The "sweep" contact maintains the connection with the rotor through consecutive positions.

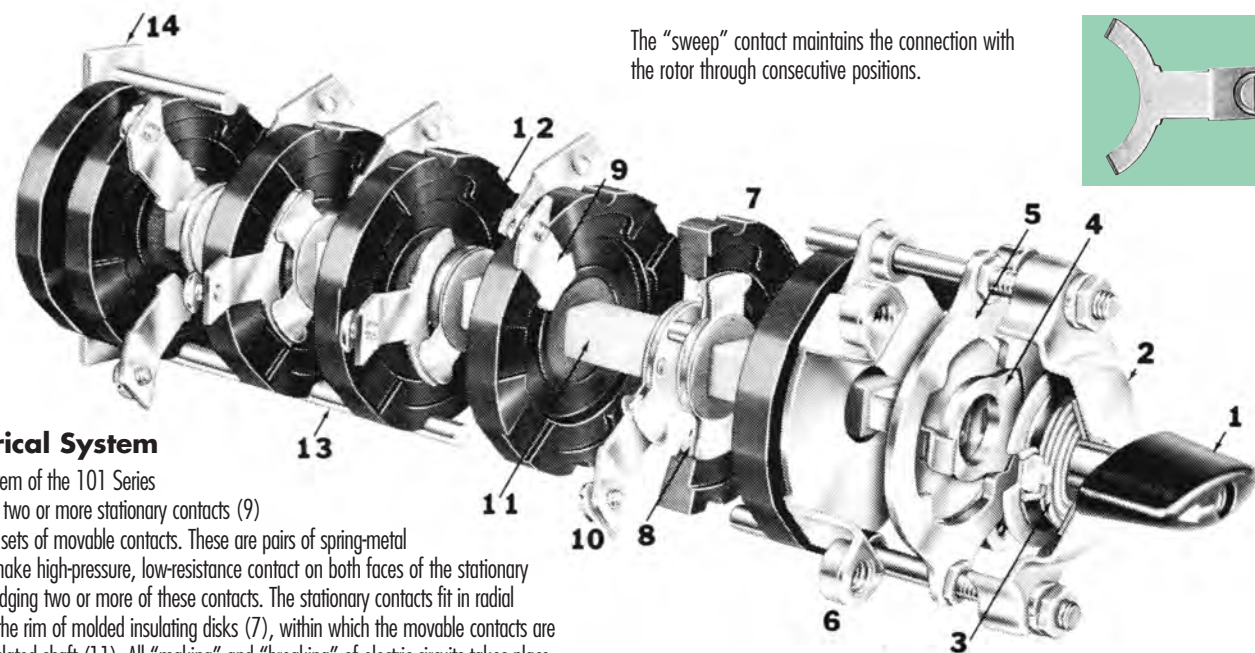

The Electrical System

The electrical system of the 101 Series Switch comprises two or more stationary contacts (9) and one or more sets of movable contacts. These are pairs of spring-metal blades (8) that make high-pressure, low-resistance contact on both faces of the stationary contacts while bridging two or more of these contacts. The stationary contacts fit in radial grooves (12) in the rim of molded insulating disks (7), within which the movable contacts are carried on an insulated shaft (11). All "making" and "breaking" of electric circuits takes place within the closed spaces between adjacent disks. Their quick-break action makes these switches particularly suitable for direct-current service. The ends of the stationary contacts extend outside the insulating disks and serve as connecting terminals (10). This one-piece contact/terminal construction minimizes series resistance and heating. Depending on current rating and on-wiring requirements, the terminals may have tapped holes for connecting screws or clearance holes for bolt connection of cable-lugs.

Moveable Contacts (Rotors)

The simple, straight-across rotor bridges stationary contacts in the same insulating disk. It provides single-throw switching in Circuit 1 and double-throw switching in Circuit 6.

The right-angle-blade rotor provides a double-throw switching, with an intermediate OFF position, in Circuit 7.

A multi-fingered blade is combined with a single-contact blade to form a composite (double-deck) rotor that interconnects stationary contacts in adjacent disks. Suitable blade arrangements provide double-throw, triple-throw, or four-throw switching.

The Mechanical System

The mechanical system of the 101 Series Switch is designed to provide uniform high-speed "make" and "break", regardless of whether the operating handle (1) is turned rapidly or slowly. Turning the handle through approximately 120° in either direction winds a powerful coil spring (3). When this is fully wound, the indexing plate (4) is momentarily withdrawn from the locking plate (5) by an eccentric cam. The drive-shaft and movable contacts then snap rapidly to the next position. The indexing plate holds them until the spring-drive mechanism is again operated. Transit time is about ten milliseconds.

Insulating Disks (and Circuits)

The insulating disks, molded of phenolic per MIL-M-14, have three functions. They hold the stationary contacts, they form enclosures that contain all making and breaking contacts, and they provide both mechanical and electrical separation of switching sections.

Assembly

The snap-drive mechanism, mechanism-cover (2), locking plate, mounting bracket (6), insulating disks, and back plate (14) are stacked on side securing rods (13) and bolted firmly together to form a rigid assembly. The handle is keyed to the operating shaft and secured by a screw.

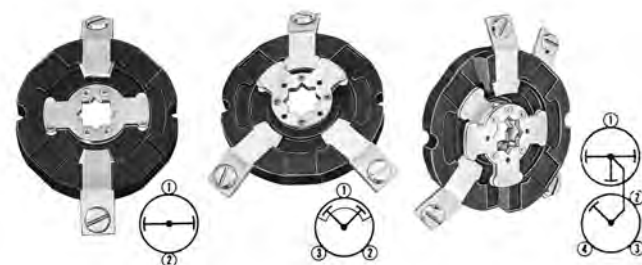



CONSTRUCTION DETAILS

SERIES 20 CAM-ACTION SWITCHES

Cam-Action Switches

The design principle allows the combination of a relatively small number of basic parts to satisfy a wide variety of requirements for selector and control switching in power circuits.

The Mechanical Design

The switch features a modular design with switching decks (3) stacked with a detent mechanism deck (6), a mounting plate (12), and a handle (13). A steel shaft (10) couples the handle to the operating parts. Two steel securing rods (11) are used to bolt the whole mechanism rigidly together. The basic parts and assemblies are shown below.

The Detent Assembly

The detent assembly (6) consists of a spring-loaded detent block (7) with a roller coming into contact with a notched detent wheel (8). This detent wheel provides the standard 45° detenting as well as optional 30°, 60° or 90° detenting. The stop arms (9) are located under the mounting plate. These limit the angular rotation to the desired number and location of positions.

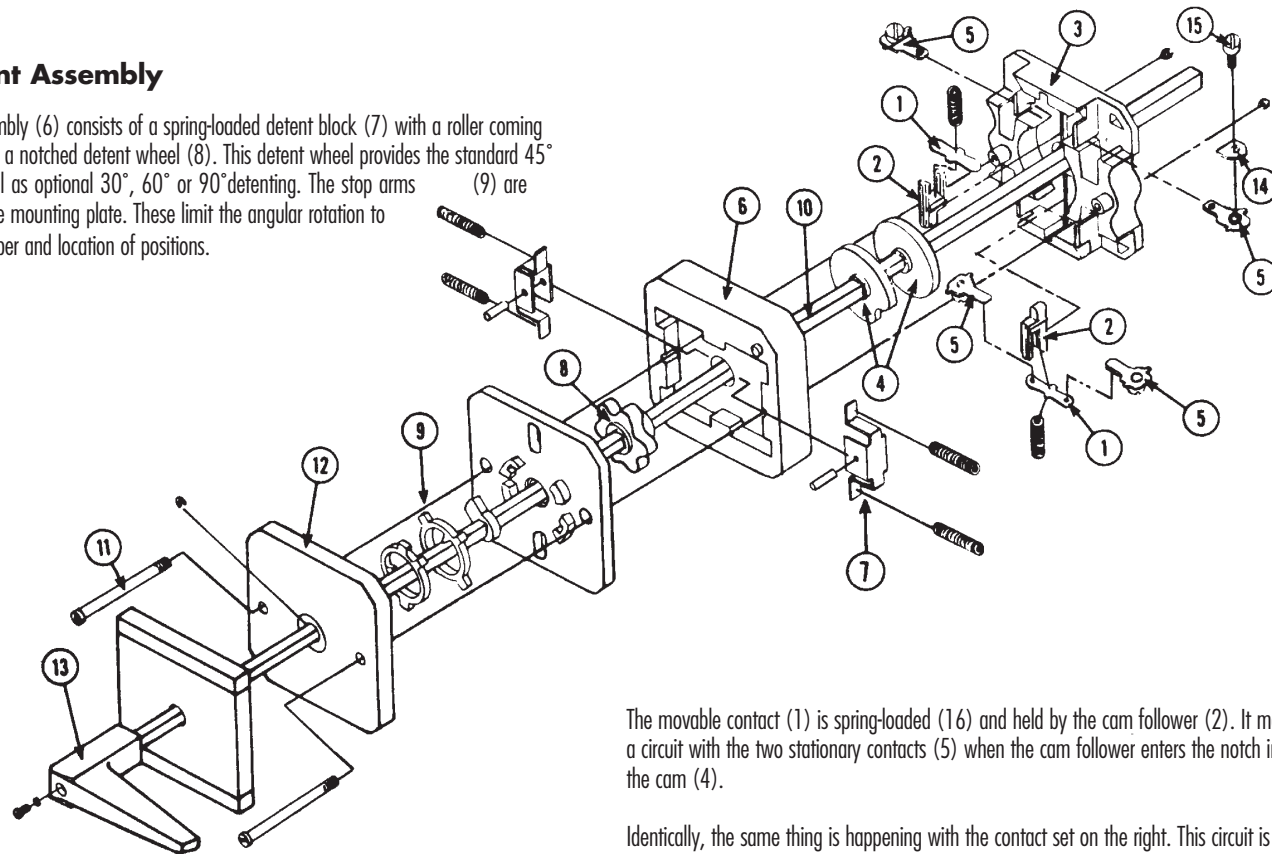

Contact Operation

The contacting consists simply of shunting two isolated contacts to make a circuit. Two independent sets of contacts are placed in each deck. The moving portion is spring-loaded to close the contact. A notch on the cam is affixed to the operating shaft allowing the moving contact to spring close, bridging the stationary contacts.

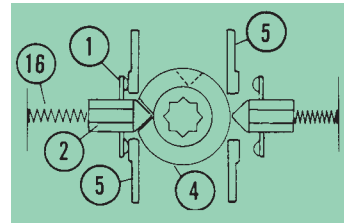

The movable contact (1) is spring-loaded (16) and held by the cam follower (2). It makes a circuit with the two stationary contacts (5) when the cam follower enters the notch in the cam (4).

Identically, the same thing is happening with the contact set on the right. This circuit is held open by the cam and will close when the notch on the second independent cam is rotated around and comes in proximity to its cam follower (the second cam notch is illustrated by the dotted lines — the cam is underneath the other one).

The Contact Assembly

The contact assembly (3) consists of a rigid thermosetting plastic housing, two sets of stationary contacts (5), and two spring-loaded (16) movable contacts (1) held in cam followers (2). Floating on the shaft and held within the contacting chamber are two independent cams (4). The cams are notched to provide the contact "close" angles desired. The contacts are spring-loaded closed and mechanically opened by the cam action to avoid sticking. The terminal screw (15) and pressure clamp (14) will easily accommodate stranded wire with lugs or solid wire, either with or without lugs, compatible with switch size.

We show the contacts pictorially to agree with typical detailed schematics and wiring plans. This simple system makes the switch contact arrangement, performance and location independent of the switching action required. The switching action is varied and controlled by the shape of the cams— allowing a virtually infinite number of combinations using a few standard parts. This simplicity and flexibility makes it easy for you to design your own switch — using familiar contact language. You eliminate the worry, long deliveries, high costs, etc. normally associated with special switches.

Note: The terminal numbering consists of individual numbers for each terminal for positive identification.



CONSTRUCTION DETAILS

TYPE W-2 INSTRUMENT AND CONTROL SWITCHES

Design Features General Construction

The W-2 Switch consists essentially of an operating handle, faceplate, control housing, contact frame assembly and rotor assembly. It can be built up in any number of stages from 1 to 8, where stages are clamped together, and to the control housing by two tie bolts. A steel operating shaft ties the contact rotors together. A metal cover on the rear holds the position stop pins and retains the shaft. For push or pull switches, the metal cover is replaced by a polycarbonate cover which houses the pull-out mechanism.

Switch Positions

The Type W-2 Switch has a minimum of two and a maximum of twelve rotary positions with a 30° throw between positions. Each rotary position coincides precisely with the nameplate markings. The degree of throw between positions is fixed and cannot be changed. In addition to rotary motion, the W-2 switch can be provided with a lateral movement (push-pull) of the handle and shaft.

Contact Frames

Two contact frame sizes are available. The half frame has six sets of contacts; three sets on the top at 11, 12 and 1 o'clock positions and three sets on the bottom at 5, 6 and 7 o'clock positions. The full frame has 12 sets of contacts, each set located at 30° intervals around it. The contact frames are made of glass polyester insulating material.

Contacts

Switches are usually referred to as "so many stages long". For a W-2 Switch, a stage of contacts consists of a contact frame (either 6 or 12 contact sets) and a rotor.

At every position location on the frame, there are two contact terminal studs in line (1 set) per stage. Each of these studs is one piece, made of bronze alloy and silver plated.

Rotors

The rotors hold the roller contacts. Each rotor, made of glass polyester insulating material, rotates independently between the stage spacer plates. The rotor assembly is equipped with one to six rollers (as determined by the required circuitry) each of which makes contact with two adjacent stationary terminal studs to complete a circuit and so affording a double series break contact. The silver-plated, bronze alloy roller contacts provide a rolling, wiping action; are self-aligning on assembly; and require no adjustment of contact pressure for the life of the switch. Contact springs do not carry current.

Switch Dial

The Type W-2 Switch Dial consists of two parts: a dial plate and a nameplate.

The standard control switch Dial plate is die cast aluminum, with red and green target parts where required, and serves as the base for mounting the nameplate. The nameplate is made of a white Cycolac ABS material on which is engraved in black the desired position marking.

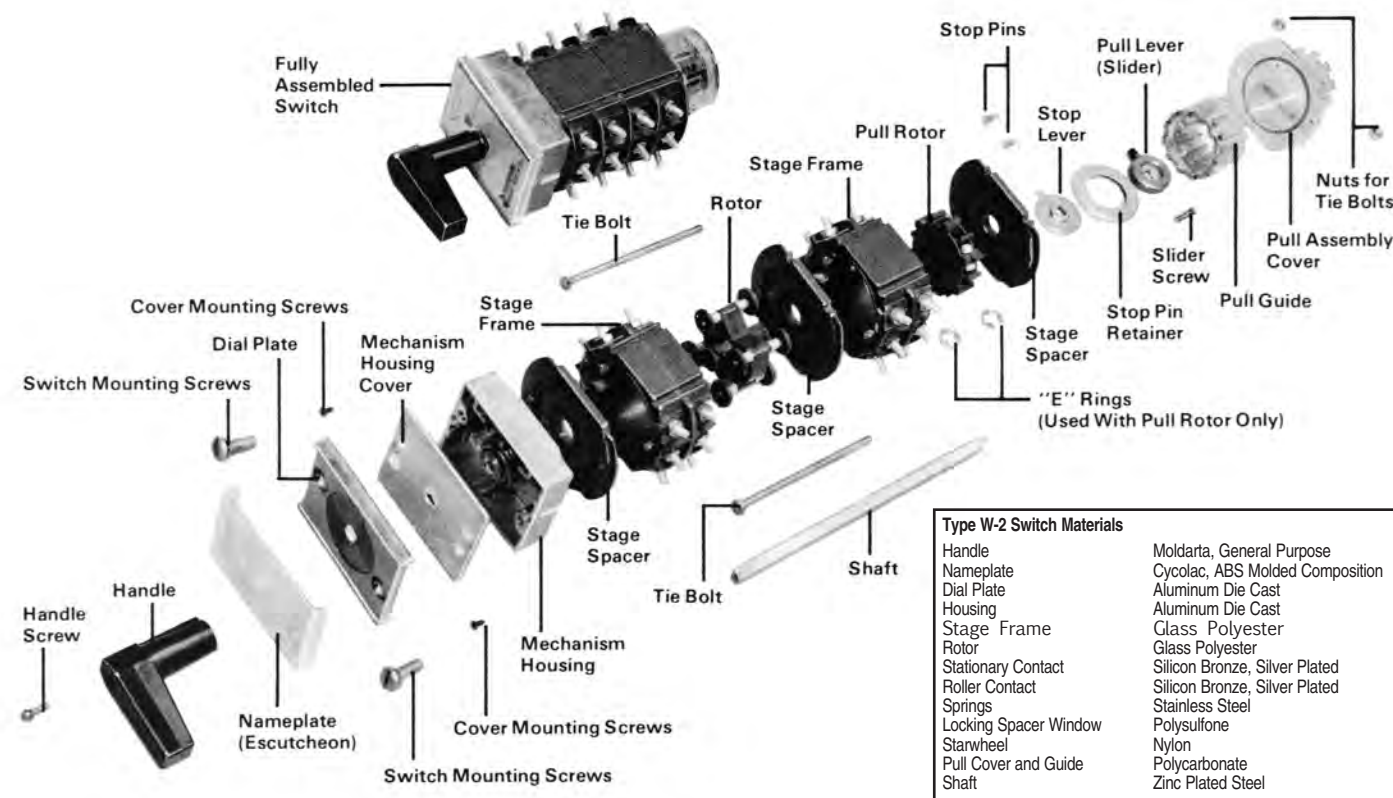



All About Testing

Switches are tested in many ways to prove their capabilities and reliability. Electroswitch uses a combination of test methods to provide meaningful data for all applications. These include:

1. Cycle it mechanically until it breaks. This is usually an academic test since switches that do not switch electric power are not needed. An exception is a setup switch whereby the switch sets up a complicated circuit and then a circuit breaker switches the power. All testing is done under electrical load.
2. Test under an application oriented specification—something that simulates actual operating conditions such as environment, overloads, surges, etc. UL1054 on SPECIAL USE SWITCHES and CSA C22.2 on INDUSTRIAL CONTROL EQUIPMENT for use in Ordinary (non-hazardous) Locations are probably the best specifications in widespread use. The Series 21, 24, 25, 28 and 31 are UL recognized and CSA certified to these specifications.
3. Test at different ratings until destruction to determine ultimate life (destruction could be mechanical failure, shorting out, dielectric failure, excessive heat rise, etc.). The test conditions are outlined on the SELECTOR CHART on page 73. The results are summarized below:

Both UL and CSA testing consists of two parts:

1. Product testing to the specifications.
2. Follow-up service by UL and CSA personnel at the factory, including inspection and testing to insure that the quality and reliability is maintained.

If all conditions are met, the switches are considered “certified electrical equipment” by CSA and “recognized components” by UL and the applications are subject to review by these agencies to assure suitability.

UL and CSA Ratings

Series	UL Recognized	CSA Certified
24	20A - 120VAC 15A - 240VAC 6A - 600VAC 3A - 125VDC 1A - 250VDC	10A - 125VAC
31	10A - 125VAC 5A - 250VAC 3A - 600VAC 5A - 30VDC 1A - 125VDC	10A - 125VAC 5A - 250VAC
101	15A-120VDC 10A-240VAC 7.5A-600VAC 10A-125VDC 5A-250VDC .5HP-120/240VAC CKT 1,2,3	15A-120VDC 10A-240VAC 5A-480VAC 3A-600VAC 10A-125VDC 5A-250VDC .5HP-120.240VAC
20	20A - 600VAC 2.5 - 125VDC	20A - 600VAC 14 HP - 600VAC
W-2	5A/125VDC 20A/240VAC 1A/250VDC 8A/600VAC	

These recognized or certified ratings are not necessarily the limits of switch capacity. They represent the acceptable tested ratings to comply with individual standards.

Tests include:

1. Overload — 50 cycles of operation.
UL — 0-10A at 150% rating ... over 10A at 125% rating
CSA — 150% rating
2. Endurance—6000 operations (DC resistive; AC at .75 to .80 pf)
3. Temperature rise of contacts 30° max. at maximum continuous current rating
4. Dielectric Voltage Withstand UL-2200V rms
5. Spacings (between live parts or live parts to ground)
UL—0-250V (3/4 in. min.) 251-600V (1/2 in. min.)

CSA	THROUGH AIR	OVER SURFACES
51-150V	.12"	.25"
151-300V	.25"	.37"
301-600V	.37"	.50"

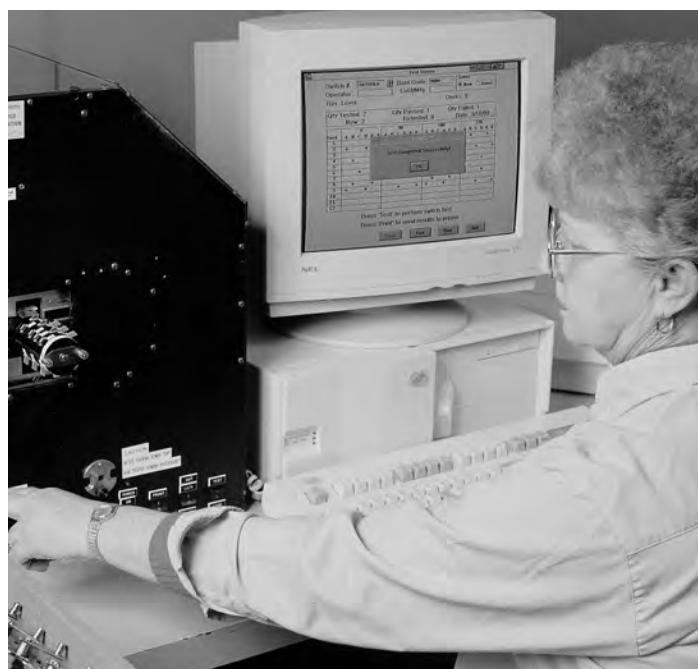



**Life Expectancy Under Electrical Load –
Make & Break Operations**

ALTERNATING CURRENT–60 Hz





SWITCH SERIES	AMPS.	125VAC		250VAC		600VAC	
		RESISTIVE	INDUCTIVE	RESISTIVE	INDUCTIVE	RESISTIVE	INDUCTIVE
24	20	10,000	10,000	10,000	10,000	10,000	10,000
	3	–	–	–	–	–	–
31	10	22,000	18,000	–	–	–	–
	5	42,000	38,000	22,000	18,000	–	–
	3	52,000	48,000	32,000	28,000	–	–
	1	70,000	65,000	50,000	45,000	30,000	25,000
	0.5	75,000	70,000	55,000	50,000	35,000	35,000
101	3	55,000	55,000	45,000	45,000	35,000	35,000
		50,000	50,000	40,000	40,000	30,000	30,000
	5	45,000	45,000	35,000	35,000	25,000	25,000
		40,000	40,000	30,000	30,000	20,000	20,000
	10	35,000	35,000	25,000	25,000	15,000	15,000
		30,000	30,000	15,000	15,000	–	–
15	20,000	20,000	10,000	10,000	–	–	
		10,000	10,000	–	–	–	–





DIRECT CURRENT





SWITCH SERIES	AMPS.	24VDC		125VDC		250VDC	
		RESISTIVE	INDUCTIVE	RESISTIVE	INDUCTIVE	RESISTIVE	INDUCTIVE
24	20	–	–	–	–	–	–
	3	–	–	10,000	10,000	–	–
31	10	–	–	–	–	–	–
	5	7,000	10,000	–	–	–	–
	3	38,000	20,000	–	–	–	–
	1	48,000	37,000	40,000	15,000	–	–
	0.5	65,000	42,000	50,000	30,000	–	–
101	3	55,000	40,000	45,000	30,000	25,000	20,000
		50,000	35,000	40,000	25,000	20,000	15,000
	5	45,000	30,000	35,000	20,000	20,000	15,000
		40,000	25,000	30,000	15,000	15,000	10,000
	10	35,000	15,000	20,000	10,000	–	–
		30,000	10,000	15,000	5,000	–	–
	15	20,000	–	–	–	–	–
		10,000	–	–	–	–	











ELECTROSWITCH ACCESSORIES HANDLES

SERIES 24				
TYPE	OVAL SHANK	OVAL SHANK-REMOVABLE	ROUND KNURLED	PISTOL-GRIP
Part No.	02000-11	002013-3	02000-10	02000-12
Screw No.	02016-4	Included	02016-4	02016-4
Lockwasher No.	02015-4	-	02015-4	02015-4
Notes	Interchangeable with other Series 24 handles	Removable at 0° std. Contact factory for other configurations	Interchangeable with other Series 24 handles	Interchangeable with other Series 24 handles

SERIES 31				
TYPE	OVAL FLUSH	OVAL SHANK	ROUND KNURLED	PISTOL-GRIP
Mount	Single Hole Mount	4 Hole Mount	4 Hole Mount	4 Hole Mount
Part No.	03029-1	03029-6-1	03029-4-1	03029-5-1
Screw No.	Included	02016-101	02016-101	02016-101
Lockwasher No.	-	02015-34	02015-34	02015-34
Notes	Single Hole Series 31 Only	Also used on Series 31 LSR	Interchangeable with Oval Shank Handles	Interchangeable with Oval Shank Handles

SERIES 20				
TYPE	OVAL SHANK	OVAL SHANK-REMOVABLE	ROUND KNURLED	PISTOL-GRIP
Part No.	100-93-38	261-24-11	100-93-68	100-93-2
Screw No.	02016-226	Included	02016-226	02016-225
Notes	Interchangeable with other Series 20 handles	Removable at 0° std. Contact factory for other configurations	Interchangeable with other Series 20 handles	Interchangeable with other Series 20 handles

SERIES 101				
TYPE	OVAL FLUSH	OVAL SHANK	PISTOL-GRIP	ROUND KNURLED
Part No.	01040-2	01040-6-1	01040-4-1	01040-5-1
Screw No.	02016-9	02016-18	02016-18	02016-18
Lockwasher No.	02015-6	02015-1	02015-1	02015-1
Notes	Uses lever screw 02016-33 Not interchangeable	Not interchangeable with Oval Flush Handle	Not interchangeable with Oval Flush Handle	Not interchangeable with Oval Flush Handle

SERIES W-2				
TYPE	OVAL SHANK	ROUND NOTCHED	PISTOL-GRIP	LARGE PISTOL-GRIP
Part No.	501B787H01	310C624H01	310C624H02	677C101G01
Screw No.	504A672G01	504A672G01	504A672G01	70001BU24B
Notes	Interchangeable with other W-2 handles except mini slim and finger tip			

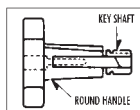



**TYPICAL W-2
REMOVABLE HANDLE**
Consult factory for part numbers and prices



NOTE: Type W Switches are supplied with black molded handles which are an integral part of the stop mechanism for position limiting of the switch. Therefore, it is important to specify the style number of the switch a handle is to be used on.









ELECTROSWITCH ACCESSORIES

NAMEPLATES

SERIES 24			
Type	Instrument & Control Switch	Target Nameplate	LOR & LOR/ER
Code No.	10	18 or 19 (PTL)	17C-2L22
Size	2.91" x 2.81"	2.91" x 2.81"	2.91" x 2.81"
Title Engraving	14 characters max	14 characters max	As Shown
Position Engraving	5 characters max	5 characters max	As Shown
Notes	For removable handle or waterproof mount use Code No. 11	No engraving available at 0° position. Target colors red & green.	Target colors black & orange.

SERIES 24			
Type	24P Lighted Instrument & Control Switch	78P Lighted Lock-Out-Relay	High Speed LOR/ER
Code No.	Contact Factory	Contact Factory	Contact Factory
Size	2.94" x 2.81"	2.94" x 2.81"	2.91" x 2.81"
Title Engraving	14 characters max	14 characters max	14 characters max
Position Engraving	5 characters max	5 characters max	5 characters max
Notes	Specify number & color of LEDs and control voltage. Available with or without Target.	Specify number & color of LEDs and control voltage. Available with or without Target.	Target colors black & orange.

SERIES 31 SERIES 20						
Type	Single Hole Mount	Four Hole Mount	Tagging Relay	Tagging Relay	Tagging Relay	20
Code No.	30	31	92TR-K	85	91	53
Size	2.0" Diameter	2.38" x 2.88"	3" x 3.5"	3" x 3.5"	5.37" x 5.66"	1.88"
Title Engraving	10 characters max	12 characters max	10 per line (2 lines max)	10 per line (2 lines max)	30 per line (3 lines max)	14 characters max
Position Engraving	6 characters max	6 characters max	7 per line (2 lines max)	7 per line (2 lines max)	8 per line (2 lines max)	5 characters max



ELECTROSWITCH ACCESSORIES

NAMEPLATES AND ACCESSORIES

SERIES 101 TYPE W-2, WL-2 AND W						
	Series	101	W-2*	W-2*	W-2 and WL-2*	Type W
	Code No.	04	61 Removable Handle	62 Target	63 Standard	73
	Size	2.38" x 2.88"	2" x 3"	2" x 3"	2" x 3"	2" x 2.375"
	Title Engraving	12 characters max	See Below	See Below	See Below	See Below
	Position Engraving	6 characters max	See Below	See Below	See Below	See Below
Notes	For waterproof mount use Code No. 5		No engraving available at 0° position. Target colors red & green.			

NOTE: Radial lines etched on nameplates will be blackened in. On engraved nameplates, only the radial lines for engraved positions will be blackened in.

TYPE W

- Nameplate Engraving Locations (1-7)
- Engraved Nameplates for W ONLY
- Use This Chart to Specify Engraving. Indicate Engraving Locations by Line Numbers Shown.

Engraving Location No.	No. of Letter Spaces Per Line
1	8
2	4
3	4
4	8
5	4
6	4
7	16

TYPE W-2

- Nameplate Engraving Locations (1-18)
- Engraved Nameplates for W-2 ONLY
- Use This Chart to Specify Engraving. Indicate Engraving Locations by Line Numbers Shown.
- Character Space Allowance is the same for Code 61, 62, and 63 Nameplates.
- Line 12 is Not Available on Code 62 (Target) Nameplates.

Engraving Location No.	No. of Letter Spaces Per Line
1-5, 7-11	6
6, 12	14
13-18	26

Series	24	31 Four Hole Mount	31 Single Hole	101
Terminal Screw No.	02016-26-C3	02016-1-C3	02016-1-C3	02016-26
Lock Washer No.	-	None	02015-1-C3	-
Stop Screw No.	02016-10	02016-10	02016-10	-
Lockwasher No.	02015-6	02015-6	02015-6	-
Mounting Screw No.	02016-87	02016-102	*	02016-103

* Nut 02017-4 (2) Locking Ring 03007-1 (1) Lockwasher 02015-5

WATERPROOF MOUNT

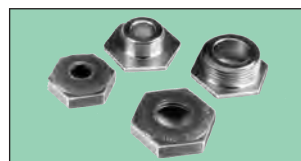

SERIES 101	
Panel Thickness	Part No.
1/16"	001022-1
1/8"	001022-2
3/16"	001022-3
Waterproof Mount Requires Special Shaft Consult Factory	
Series 31 Single Hole Mount	
Panel Thickness	Part No.
3/16" Max	02017-8

LENSES AND LEDS

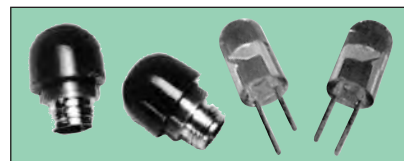

Color Lens	Series 20P Part No.	Series 24P Part No.
Red	100-93-5	658-402-1
Green	100-93-6	658-403-1
Amber	100-93-7	658-401-1
White	100-93-31	658-405-1
Blue	100-93-36	658-404-1
Bulb	245-8-910	

SERIES 24 TRIP COIL FOR LOR



Coil	Nominal Voltage	Part No.
A	24VDC	002008-12A-3
B	24VDC	002008-12B-3
C	48VDC	002008-12C-3
D	125VDC/120VAC	002008-12D-3
E	125VDC	002008-12E-3
F	250VDC/240VAC	002008-12F-3
K	125VDC	002008-14D-3

SERIES WL-2 TRIP COIL FOR LOR



Nominal Voltage	Part No.
24VDC	349A556G01
48VDC	349A556G01
125VDC	349A556G02
250VDC	349A556G02
120VAC	349A556G10
250VAC	349A556G10



	Series 24	Series 31 – Single Hole	Series 31 – Four Hole	Series 20	Series 101
Adjacent Contact (Same Deck)	02011-10-C3	03057-1-C3	03057-1-C3	261-23-1-C1	–
Same Contact (Adjacent Deck)	02011-12-C3	03059-1-C3	03059-1-C3	261-23-2-C1	–
2" Wire & Lugs	002012-1	00314-1	00314-1	261-26-3	002012-5
3" Wire & Lugs	002012-2	00314-2	00314-2	261-26-4	002012-6
5" Wire & Lugs	002012-3	00314-3	00314-3	261-26-5	002012-7

TYPE W-2 TYPICAL SIX CONTACT STAGE

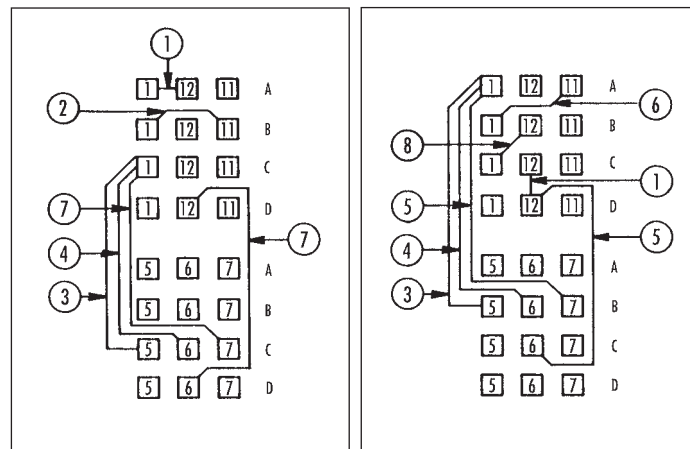

TYPICAL TWELVE CONTACT STAGE

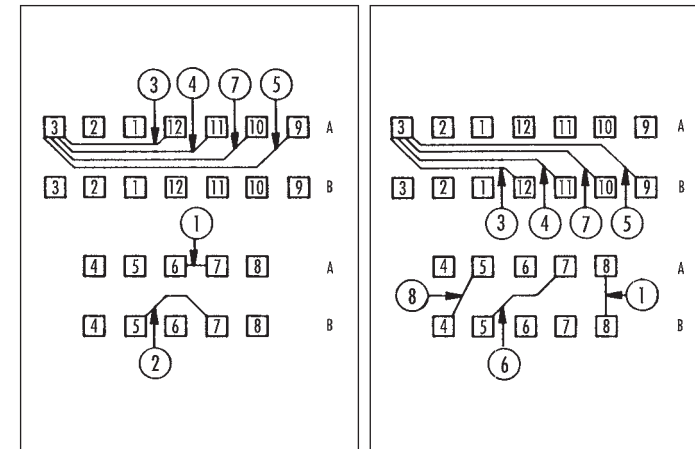

TERMINAL CONNECTORS

The Type W-2 Switch gains additional flexibility with the use of terminal connectors (jumpers) applied to the switch terminals. The chart below shows the connectors required for the most common applications. Order connectors by style No. from the reference list to the right.

Conn. #	Style Number	Dim "A"	Examples:
#1	677C519H08	.89"	Conn. #1
#2	677C519G01	1.59"	Conn. #2
#3	677C782G01	3.50"	
#4	677C782G02	4.25"	
#5	677C782G04	5.50"	
#6	677C519G05	1.59"	Conn. #6
#7	677C782G03	5.00"	
#8	677C519G07	1.22"	Conn. #8
#9	677C782G05	6.00"	
#10	677C782G06	7.25"	
#11	677C782G07	9.75"	
#12	677C782G08	10.50"	

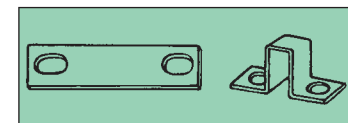

Metal jumpers are supplied in packages of 10 or 25.

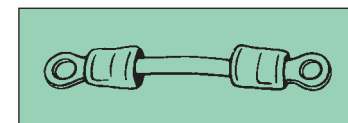

Wire jumpers are ordered individually.

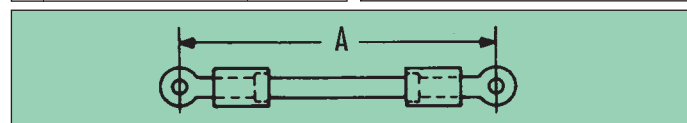

NOTE: Typical Wire & Lug Type Connector. Wire & Lugs are ordered individually.



WARRANTY

All products and components manufactured by Electroswitch are warranted for a period of one year after date of shipment. All products manufactured by Electroswitch require special tools and fixtures to assure reliable operation of these products. Our ratings, both electrical and mechanical, are maintained only through extensive testing after proper assembly. The independent approvals such as UL, CSA, and various Military Agencies, can be maintained only with complete control over the manufacture of these products. It is the policy of Electroswitch not to sell any internal spare parts. Any alteration of the products will automatically void this warranty, and Electroswitch will assume no liability for any resulting damage.

The Best Rotary Switches, Relays, and Electrical Systems Products...

Backed by the industry's most knowledgeable and responsive engineering and customer service professionals...

Any way you want them...

Delivered when you need them.



NEVER A DOUBT

THE ELECTRO SWITCH CORPORATION FAMILY... PROVIDING INTELLIGENT SOLUTIONS FOR SWITCHING AND CONTROL

ELECTROSWITCH POWER SWITCHES & RELAYS

Complete line of electrically and manually activated Rotary Switches and Relays for electric utility, defense, and industrial monitoring and control applications



www.electroswitch.com

ELECTROSWITCH ELECTRONIC PRODUCTS

Rotary Switches; Miniature Toggle, Paddle, Rocker, Power Toggle, and Push-Button Switches; Hall Effect, and Mechanical Encoders; Illuminated Switch Products; and Power Transformers



www.electro-nc.com

DIGITRAN DIGITAL & ROTARY SWITCHES

Digital and Rotary Switch Products designed for aviation, defense, and industrial switch applications



www.digitran-switches.com

ARGA CONTROLS MEASUREMENT & CONTROL INSTRUMENTATION

Electric utility, industrial and military-grade Power Meters, Battery Monitors, and Transducers for precision measurement applications



www.argacontrols.com

Sunrise Technologies OUTDOOR LIGHTING CONTROLS & MONITORING

Wireless Communication Systems for Smart Grid applications and a complete line of Streetlight Monitoring and Control Solutions



www.sun-tech.biz

NEVER A DOUBT



ELECTROSWITCH

ELECTROSWITCH Corporation
180 King Avenue
Weymouth, MA 02188
TEL: (781) 335-5200
FAX: (781) 335-4253
www.electroswitch.com



ELECTROSWITCH
UTILITY
PRODUCTS



Printed in USA 5M 113

Switches and Relays For the Power Industry



X-ON Electronics

Largest Supplier of Electrical and Electronic Components

Click to view similar products for [Switch Fixings](#) category:

Click to view products by [Electroswitch](#) manufacturer:

Other Similar products are found below :

[893102000](#) [00-5150](#) [LZZ1A](#) [0098.9234](#) [61-9451.0](#) [M2PA-5011](#) [630155](#) [635401](#) [6PA113](#) [6PA147-E6](#) [6PA148-E6](#) [6PA32](#) [6PA9](#) [700106](#)
[700109](#) [700303A56](#) [700C1GRY](#) [700C2GRN](#) [704-6001](#) [704.960.9](#) [704.965.2](#) [704.965.6](#) [704.966.0](#) [7089-3](#) [710082-B11](#) [71M1048](#)
[757200264](#) [764300000](#) [MHU35](#) [MHU37](#) [807039-1](#) [825.003.011](#) [825.005.011](#) [825.053.011](#) [825.055.011](#) [826.000.071](#) [827.020.011](#)
[827.400.021](#) [835.900.023](#) [MML52C10C](#) [MML52E10C](#) [MML92HGH](#) [MML93K](#) [84211M02CNNS](#) [84212M02CNNS](#) [84217A8.0LNOS](#)
[842.500.011](#) [843.000.011](#) [843187-000](#) [843487-000](#)