

**Commercial Miniature Toggle Switches**

**SPECIFICATIONS**

- Originally designed to meet the requirements of MIL-S-83731 (see page 54 for Test Specifications).
- Sealed lever type with panel seal and terminal seal.
- Flatted bushing on sealed lever type.
- Solder lug or printed circuit terminals.
- Epoxy sealed terminals.
- One and two pole circuits.
- High electrical/mechanical reliability.
- Dry circuit current carrying ability.
- Toggle lever throw 25° ±5°.

**MATERIAL**

- Base (body)** — Diallyl Phthalate.
- Lever** — Brass, bright chrome plated.
- Bushing** — Brass, nickel plated.  
**Frame** — Stainless steel.
- Switching Contacts and Rockers** — 50 millionths gold over silver.
- Center Terminal** — 50 millionths gold over silver.
- Hardware** — Refer to hardware listing on page 57.



**CURRENT RATINGS**

Current Capacity in Amperes — Per Pole		
28 V DC	115 V AC 400 Hz	125 V AC 60 Hz
LAMP LOAD		
1	1	1
RESISTIVE LOAD		
5	5	5
INDUCTIVE LOAD		
2	2	2

**LOGIC LEVEL**

10 mA @ 5 V Max. (AC or DC)
-----------------------------

**SWITCH SELECTION TABLE — SEALED**

	Circuit With Lever			Catalog Number	
	UP Position	CENTER Position	DOWN Position (Flat)	Solder Lug Terminals	Printed Circuit Terminals
<b>ONE POLE</b>					
	ON	OFF	ON	A121S1CWZG-M8	A121S1CWCG-M8
	ON	NONE	ON	A123S1CWZG-M8	A123S1CWCG-M8
	ON	NONE	ON*	A126S1CWZG-M8	A126S1CWCG-M8
	ON*	OFF	ON*	A127S1CWZG-M8	A127S1CWCG-M8
	ON	OFF	ON*	A131S1CWZG-M8	A131S1CWCG-M8
	NONE	ON	ON*	A137S1CWZG-M8	A137S1CWCG-M8
<b>TWO POLE</b>					
	ON	OFF	ON	A221S1CWZG-M8	A221S1CWCG-M8
	ON	NONE	ON	A223S1CWZG-M8	A223S1CWCG-M8
	ON	NONE	ON*	A226S1CWZG-M8	A226S1CWCG-M8
	ON*	OFF	ON*	A227S1CWZG-M8	A227S1CWCG-M8
	ON	OFF	ON*	A231S1CWZG-M8	A231S1CWCG-M8
	ON	ON	ON	A232S1CWZG-M8	A232S1CWCG-M8
	ON	ON	ON*	A233S1CWZG-M8	A233S1CWCG-M8
	NONE	ON	ON*	A234S1CWZG-M8	A234S1CWCG-M8
	ON*	ON	ON*	A235S1CWZG-M8	A235S1CWCG-M8

\* Momentary Contact

**"ON-ON-ON" CIRCUIT DIAGRAM**

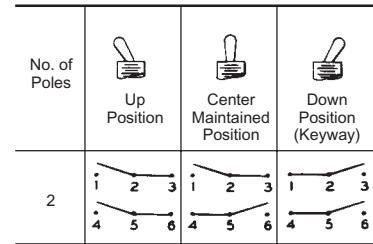

**APPROXIMATE DIMENSIONS**

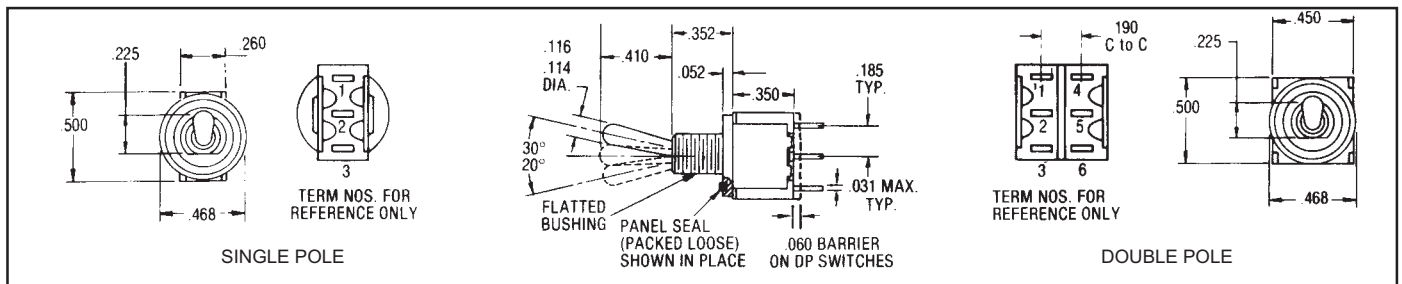

**TERMINAL DIMENSIONS**

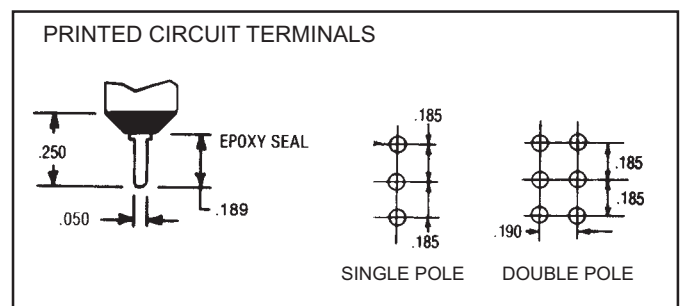
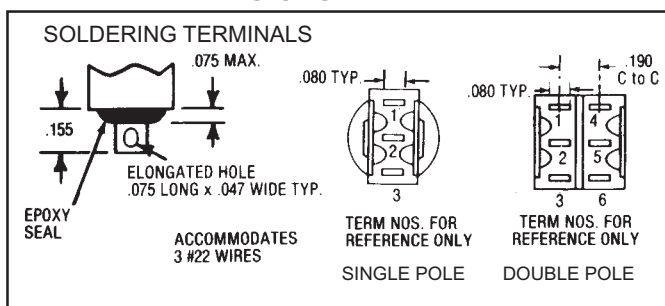

**Commercial Miniature Leverlock Toggle Switches — Unsealed**

**SPECIFICATIONS**

- One hole mounting.
- Originally designed to meet the requirements of MIL-S-83731 (see page 54 for Test Specifications).
- Slow make, slow break contact action.
- High electrical/mechanical reliability.
- Toggle lever throw 25° ±5°.
- Solder lug or printed circuit terminals.
- One and two pole circuits.
- Dry circuit current carrying ability.
- Mounting hardware furnished unassembled

**MATERIAL**

- **Base (body)** — Diallyl Phthalate.
- **Locking lever** — Brass, nickel plated.  
**Cap** — natural anodized aluminum supplied as standard; other colors such as red, blue, gold, black and green are also available.
- **Bushing** — Brass, nickel plated.  
**Frame** — Stainless steel.
- **Switching Contacts and Rockers** — 50 millionths gold over silver.
- **Center Terminal** — 50 millionths gold over silver.
- **Hardware** — Refer to hardware listing on page 57.

**CURRENT RATINGS**

Current Capacity in Amperes — Per Pole		
28 V DC	115 V AC 400 Hz	125 V AC 60 Hz
LAMP LOAD		
1	1	1
RESISTIVE LOAD		
5	5	5
INDUCTIVE LOAD		
2	2	2

**LOGIC LEVEL**

10 mA @ 5 V Max. (AC or DC)
-----------------------------

**LEVER LOCK SELECTION TABLE**

Standard Cap Style	Circuit With Lever				Catalog Number	
	UP Position	CENTER Position	DOWN Position (Keyway)	Lever Lock Bushing Style	Solder Lug Terminals	Printed Circuit Terminals
 <p>SPDT</p> <p>DPDT</p>	<b>ONE POLE</b>					
	ON ▶	◀OFF▶	◀ON	1	A121K12KZG-M8	A121K12KCG-M8
	ON ▶	NONE	◀ON	2	A123K12KZG-M8	A123K12KCG-M8
	ON ▶	NONE	ON*	3	A126K12KZG-M8	A126K12KCG-M8
	ON*	◀OFF▶	ON*	4	A127K12KZG-M8	A127K12KCG-M8
	ON ▶	◀OFF▶	ON*	5	A131K12KZG-M8	A131K12KCG-M8
	<b>TWO POLE</b>					
	ON ▶	◀OFF▶	◀ON	1	A221K12KZG-M8	A221K12KCG-M8
	ON ▶	NONE	◀ON	2	A223K12KZG-M8	A223K12KCG-M8
	ON ▶	NONE	ON*	3	A226K12KZG-M8	A226K12KCG-M8
ON*	◀OFF▶	ON*	4	A227K12KZG-M8	A227K12KCG-M8	
ON ▶	◀OFF▶	ON*	5	A231K12KZG-M8	A231K12KCG-M8	
ON ▶	◀ON▶	◀ON	1	A232K12KZG-M8	A232K12KCG-M8	

\* Momentary Contact  
▶ Indicates direction against which lever is locked.

**APPROXIMATE DIMENSIONS** (For terminal dimensions see page 49)

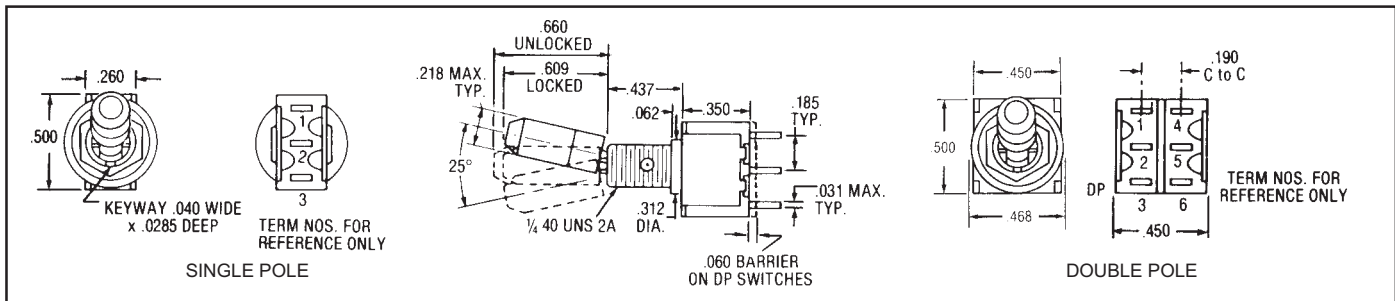

**LEVER LOCK BUSHING STYLES**

(The descriptive illustrations below are for pictorial representation only — keyway on right hand side)

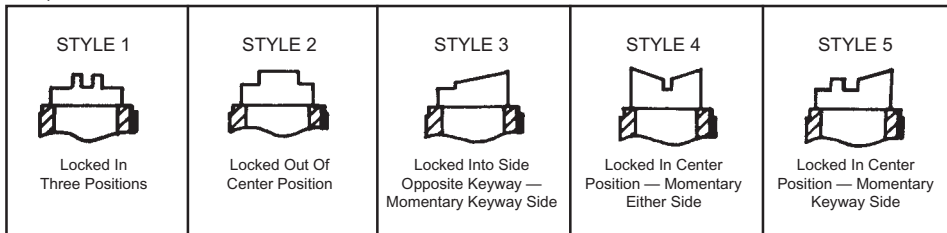

**"ON-ON-ON" CIRCUIT DIAGRAM**

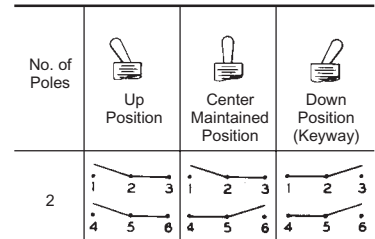

**Commercial Miniature Toggle Switches  
Right Angle Mount (Vertical) P.C. Terminals**

**SPECIFICATIONS**

- Originally designed to meet the requirements of MIL-S-83731 (see page 54 for Test Specifications).
- Sealed lever type with panel seal and terminal seal.
- Right angle mount (vertical) printed circuit terminals.
- Epoxy sealed printed circuit terminals.
- One and two pole circuits.
- High electrical/mechanical reliability.
- Dry circuit current carrying ability.
- Toggle lever throw  $25^\circ \pm 5^\circ$ .

**MATERIAL**

- **Base (body)** — Diallyl Phthalate.
- **Lever** — Brass, bright chrome plated.
- **Bushing** — Brass, nickel plated.  
**Frame** — Stainless steel.
- **Switching Contacts and Rockers** — 50 millionths gold over silver.
- **Center Terminal** — 50 millionths gold over silver.
- **Hardware** — None required.



**CURRENT RATINGS**

Current Capacity in Amperes — Per Pole		
28 V DC	115 V AC 400 Hz	125 V AC 60 Hz
LAMP LOAD		
1	1	1
RESISTIVE LOAD		
5	5	5
INDUCTIVE LOAD		
2	2	2

**LOGIC LEVEL**

10 mA @ 5 V Max. (AC or DC)
-----------------------------

**SWITCH SELECTION TABLE — SEALED**

	Circuit With Lever In...			Catalog Number
	UP Position	CENTER Position	DOWN Position (Position C)	
 SPDT	ON	OFF	ON	A121M1D9AVG-M8
	ON	NONE	ON	A123M1D9AVG-M8
	ON	NONE	ON*	A126M1D9AVG-M8
	ON*	OFF	ON*	A127M1D9AVG-M8
	ON	OFF	ON*	A131M1D9AVG-M8
	NONE	ON	ON*	A134M1D9AVG-M8
 DPDT	ON	OFF	ON	A221M1D9AVG-M8
	ON	NONE	ON	A223M1D9AVG-M8
	ON	NONE	ON*	A226M1D9AVG-M8
	ON*	OFF	ON*	A227M1D9AVG-M8
	ON	OFF	ON*	A231M1D9AVG-M8
	ON	ON	ON	A232M1D9AVG-M8
	ON	ON	ON*	A233M1D9AVG-M8
	NONE	ON	ON*	A234M1D9AVG-M8
	ON*	ON	ON*	A235M1D9AVG-M8

\* Momentary Contact

**APPROXIMATE DIMENSIONS**

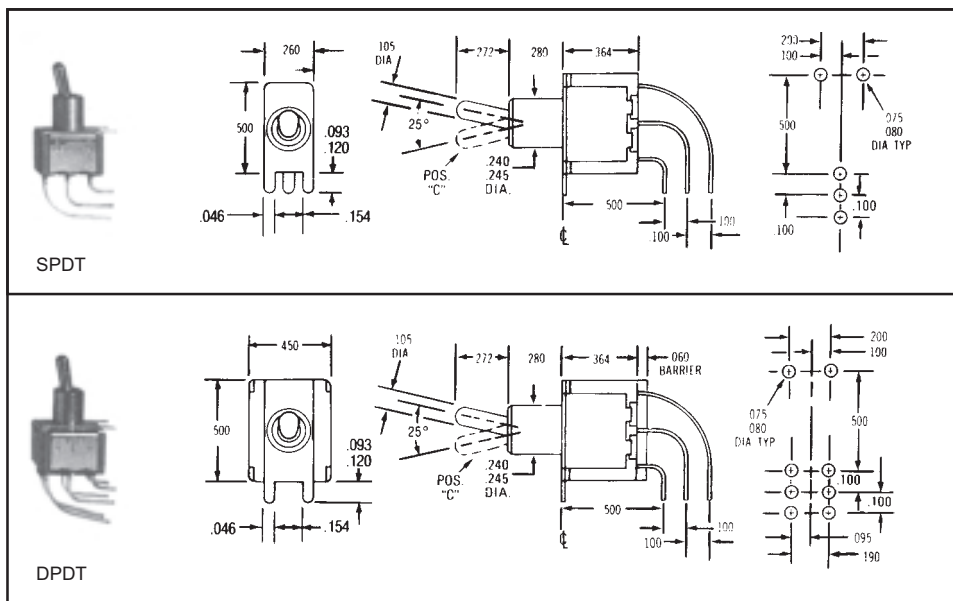

**TERMINAL DIMENSIONS**

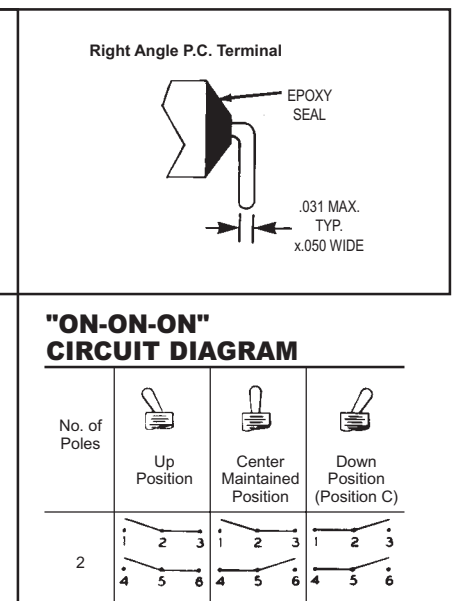

**Commercial Miniature Toggle Switches  
Right Angle Mount (Horizontal) P.C. Terminals**

**SPECIFICATIONS**

- Originally designed to meet the requirements of MIL-S-83731 (see page 54 for Test Specifications).
- Sealed lever type with terminal seal.
- Right angle mount (horizontal) printed circuit terminals.
- Epoxy sealed printed circuit terminals.
- One and two pole circuits.
- High electrical/mechanical reliability.
- Dry circuit current carrying ability.
- Toggle lever throw  $25^\circ \pm 5^\circ$ .

**MATERIAL**

- Base (body)** — Diallyl Phthalate.
- Lever** — Brass, bright chrome plated.
- Bushing** — Brass, nickel plated.  
**Frame** — Stainless steel.
- Switching Contacts and Rockers** — 50 millionths gold over silver.
- Center Terminal** — 50 millionths gold over silver.
- Hardware** — None required.



**CURRENT RATINGS**

Current Capacity in Amperes — Per Pole		
28 V DC	115 V AC 400 Hz	125 V AC 60 Hz
LAMP LOAD		
1	1	1
RESISTIVE LOAD		
5	5	5
INDUCTIVE LOAD		
2	2	2

**LOGIC LEVEL**

10 mA @ 5 V Max. (AC or DC)

**SWITCH SELECTION TABLE — SEALED**

	Circuit With Lever In...			Catalog Number
	UP Position	CENTER Position	DOWN Position (Position C)	
 SPDT	ON	OFF	ON	A121M1D9AG-M8
	ON	NONE	ON	A123M1D9AG-M8
	ON	NONE	ON*	A126M1D9AG-M8
	ON*	OFF	ON*	A127M1D9AG-M8
	ON	OFF	ON*	A131M1D9AG-M8
	NONE	ON	ON*	A134M1D9AG-M8
 DPDT	ON	OFF	ON	A221M1D9AG-M8
	ON	NONE	ON	A223M1D9AG-M8
	ON	NONE	ON*	A226M1D9AG-M8
	ON*	OFF	ON*	A227M1D9AG-M8
	ON	OFF	ON*	A231M1D9AG-M8
	ON	ON	ON	A232M1D9AG-M8
	ON	ON	ON*	A233M1D9AG-M8
	NONE	ON	ON*	A234M1D9AG-M8
	ON*	ON	ON*	A235M1D9AG-M8

\* Momentary Contact

**APPROXIMATE DIMENSIONS**

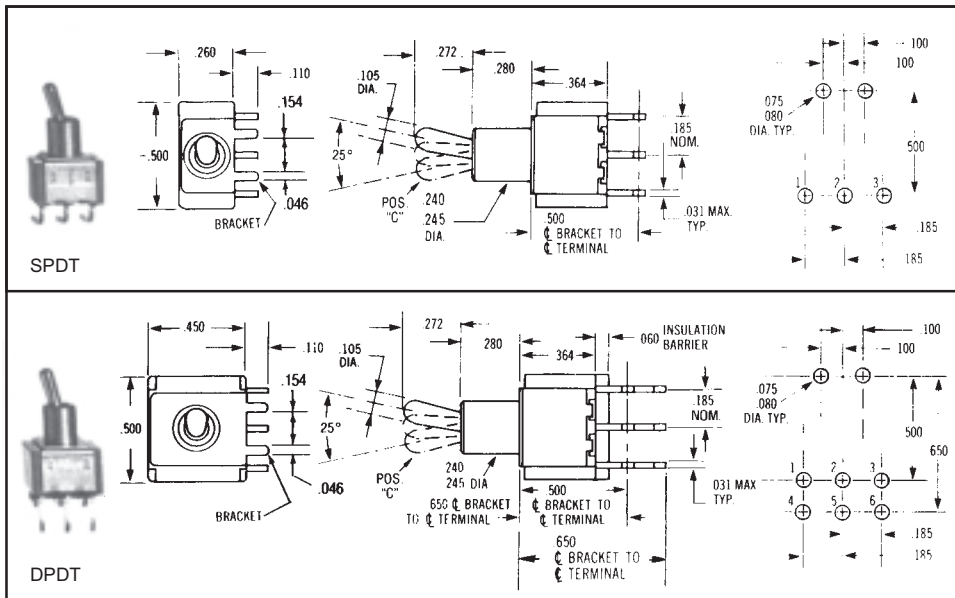

**TERMINAL DIMENSIONS**

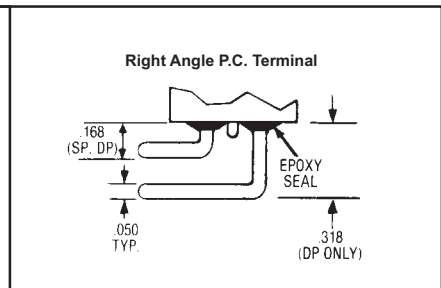

**"ON-ON-ON" CIRCUIT DIAGRAM**

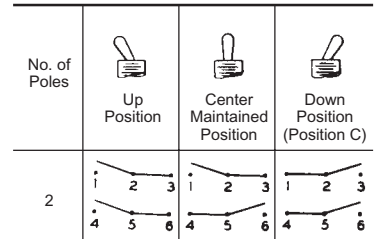

**Commercial Miniature Toggle Switches – New Four Pole**

**SPECIFICATIONS**

- Originally designed to meet the requirements of MIL-S-83731 (see page 54 for Test Specifications).
- Sealed lever type with panel seal and terminal seal.
- Flatted bushing on sealed lever type.
- Solder lug or printed circuit terminals.
- Epoxy sealed terminals.
- One and two pole circuits.
- High electrical/mechanical reliability.
- Dry circuit current carrying ability.
- Toggle lever throw 25° ±5°.

**MATERIAL**

- **Base (body)** — Diallyl Phthalate.
- **Lever** — Brass, bright chrome plated.
- **Locking Lever** — Brass, nickel plated.  
**Cap** — natural anodized aluminum supplied as standard; other colors such as red, blue, gold, black and green are also available.
- **Bushing** — Brass, nickel plated.  
**Frame** — Stainless steel.
- **Switching Contacts and Rockers** — 50 millionths gold over silver.
- **Center Terminal** — 50 millionths gold over silver.
- **Hardware** — Refer to hardware listing on page 57.

**CURRENT RATINGS**

Current Capacity in Amperes — Per Pole		
28 V DC	115 V AC 400 Hz	125 V AC 60 Hz
LAMP LOAD		
1	1	1
RESISTIVE LOAD		
5	5	5
INDUCTIVE LOAD		
2	2	2

**LOGIC LEVEL**

10 mA @ 5 V Max. (AC or DC)
-----------------------------

**SWITCH SELECTION TABLE — SEALED**

	Circuit With Lever In...			Catalog Number	
	UP Position	CENTER Position	DOWN Position (Flat)	Solder Lug Terminals	Printed Circuit Terminals
 4-PDT	ON	OFF	ON	A421S1CWZG-M8	A421S1CWCG-M8
	ON	NONE	ON	A423S1CWZG-M8	A423S1CWCG-M8
	ON	NONE	ON*	A426S1CWZG-M8	A426S1CWCG-M8
	ON*	OFF	ON*	A427S1CWZG-M8	A427S1CWCG-M8
	ON	OFF	ON*	A431S1CWZG-M8	A431S1CWCG-M8
	ON	ON	ON	A432S1CWZG-M8	A432S1CWCG-M8
	ON	ON	ON*	A433S1CWZG-M8	A433S1CWCG-M8
	NONE	ON	ON*	A434S1CWZG-M8	A434S1CWCG-M8
	ON*	ON	ON*	A435S1CWZG-M8	A435S1CWCG-M8

\* Momentary Contact

**LEVER LOCK SELECTION TABLE — UNSEALED**

Standard Cap Style	Circuit With Lever In...			Lever Lock Bushing Style	Catalog Number	
	UP Position	CENTER Position	DOWN Position (Keyway)		Solder Lug Terminals	Printed Circuit Terminals
 FOUR POLE	ON ▶	◀ OFF ▶	◀ ON	1	A421K12KZG-M8	A421K12KCG-M8
	ON ▶	NONE	◀ ON	2	A423K12KZG-M8	A423K12KCG-M8
	ON ▶	NONE	ON*	3	A426K12KZG-M8	A426K12KCG-M8
	ON*	◀ OFF ▶	ON*	4	A427K12KZG-M8	A427K12KCG-M8
	ON ▶	◀ OFF ▶	ON*	5	A431K12KZG-M8	A431K12KCG-M8
	ON ▶	◀ ON ▶	◀ ON	1	A432K12KZG-M8	A432K12KCG-M8

\* Momentary Contact

▶ Indicates direction against which lever is locked.

**APPROXIMATE DIMENSIONS**

(For terminal dimensions see page 49)

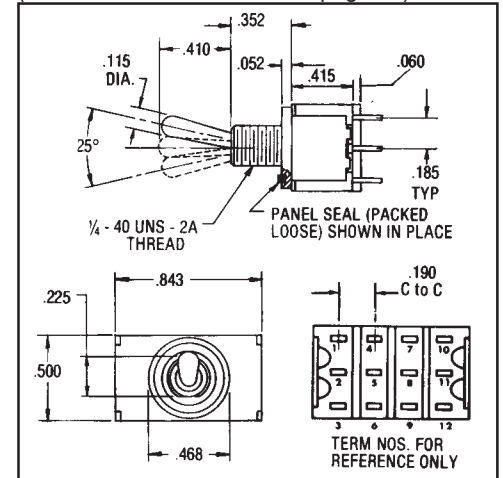

**APPROXIMATE DIMENSIONS** (For terminal dimensions see page 49)

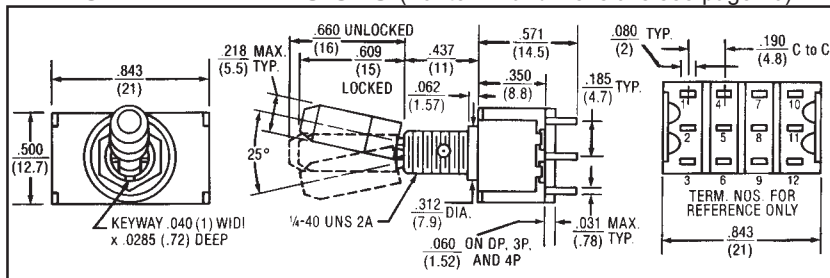

**"ON-ON-ON" CIRCUIT DIAGRAM**

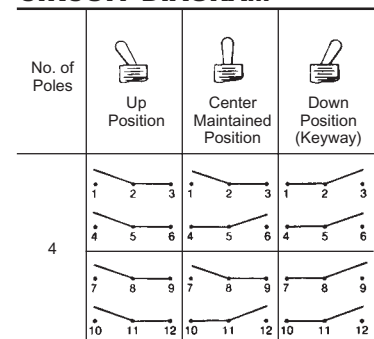

NOTE: FOR LEVER LOCK BUSHING STYLES SEE PAGE 50.

**Rating, Cross Reference and Engineering Data**
**“A” Series Originally Designed To Meet  
the Following MIL Specifications**

Test Requirement	MIL Specification
1. Strength of Terminal	1 lb. — solder lug
2. Strength of Actuating Lever Pivot and Stop	10 lbs. & 8 lbs. throughout range
3. Strength of Mounting Means	15 lbs. in. torque on bushing
4. Dielectric (Sea Level) Indication Dielectric (Altitude)	1000 VAC Group C 750 VAC after electrical endurance. 500 $\mu$ A max. leakage
5. Contact Voltage Drop	2.5 millivolt initial 5.0 millivolt after mechanical endurance @ 2-6 VDC 0.1 amp.
6. Temperature Rise	50°C rise @ rated resistance after endurance test current
7. Short Circuit	10 operations make and carry 100 amps resistive load @ lowest DC volts
8. Mechanical Life	20K operations at specified high and low temperatures
9. Electrical Endurance	10K operations at specified high and low temperatures
10. Overload	50 operations @ 150% of rated resistive load
11. A) Electrical Endurance at Altitude	No requirement
B) Electrical Endurance at Sea Level	10K operations resistive load @ room temperature 10K operations inductive load @ room temperature 10K operations lamp load @ room temperature Performed on different test samples
12. Vibration	Method 204 of MIL-STD-202, test condition A .06 D.A. or 10 G's 10-500 Hz 10 usec. max. chatter
13. Shock	Fuse-method 213 or MIL-STD @75 G's 10 usec. max, chatter
14. Salt Spray Test Upon Completion	48 hours — method 101 of MIL-STD-202, test condition B 10 operations resistive load (toggle sealed switches only)
15. Moisture Resistance Test Upon Completion	Method 106 of MIL-STD-202 100 VDC potential between current carrying parts and panel
16. Sand & Dust	Method 110 of MIL-STD-202, test condition B 6 hours @ 23°C 2.5K operations mechanical life (toggle sealed switches only)
17. Explosion	MIL-STD-202 method 109, maximum rated DC inductive load (toggle sealed switches only)
18. Sealing	Toggle seal — 5 operations under 0.5 inches of H <sub>2</sub> O above top of bushing
19. A) Toggle Seal B) Bushing Seal	No requirement
20. Temperature Operation	Mechanical life, -25°C to +71°C
21. Life Low Cur. Level	No requirement
22. Fungus	No requirement
23. Intermediate Current	10K operations, 50 milliamps @ 10 VDC resistive load @ 20,000 feet altitude @ room temperature
24. Thermal Shock	Method 107 of MIL-STD-202 test condition A 5 cycles @ -55°C/+85°C

## X-ON Electronics

Largest Supplier of Electrical and Electronic Components

*Click to view similar products for [Toggle Switches](#) category:*

*Click to view products by [Electroswitch](#) manufacturer:*

Other Similar products are found below :

[A19HV](#) [8A1-C-222](#) [60012L](#) [6006L](#) [6663](#) [7101MD9V30GE](#) [7101SPDV30BE](#) [7103SDV30BE](#) [7105D](#) [7108P3YAV2BE](#) [71YY50282](#)  
[7201MD9AVBE](#) [7301K38](#) [7306K36](#) [7310K36](#) [7314K36](#) [7506K4](#) [7592K6](#) [7691K14](#) [7700K1](#) [8396K108](#) [8824K14](#) [8828K13](#) [G3VX](#) [PS83-](#)  
[121G](#) [A101MD9AB04](#) [A101SD9AB04](#) [A101SDCQ04](#) [A103SD9AQ04](#) [A107TZB04](#) [A123P32YZQ](#) [A123S1YZG](#) [A127S1YCQ](#) [1-1825192-](#)  
[0](#) [A131S1YZQ](#) [A201SCWZB04](#) [A207SYCB04](#) [A208J61ZQ0004](#) [A221K12KAG](#) [A221S1YZQ](#) [A221T1TCQ](#) [A232K12KZQ](#) [A232M1YCQ](#)  
[A323S1CWZQ](#) [A423S1YZQ](#) [12149A-3V](#) [12156AX408](#) [12147AGKX679](#) [12149AD2G0383VX408](#) [12246X778](#)