

# PRODUCT OVERVIEW

## 2018



[www.emasas.com.tr](http://www.emasas.com.tr) | [www.emas.uk.com](http://www.emas.uk.com)







# Extensive range of Electromechanical Products

1000's of different product types in 18 ranges  
Internationally available in more than 65 countries



• ROTARY CAM SWITCHES • CONTACTORS • INDUSTRIAL RELAYS & SOCKETS • ELECTRONIC PRODUCTS • SAFETY PRODUCTS • CRANE PRODUCTS • LIFT PRODUCTS • CABLE CARRIERS  
• CONTROL UNITS AND PILOT LIGHTS • INDUSTRIAL PLUGS & SOCKETS • SIGNALLING DEVICES • MOTOR PROTECTION CIRCUIT BREAKERS • LEVEL CONTROL FLOAT SWITCHES  
• CONTROL BOXES • FOOT SWITCHES • LIMIT SWITCHES • SENSORS • BASIC SWITCHES

Inspiring innovation



[www.emasas.com.tr](http://www.emasas.com.tr) | +90 212 549 2252  
[www.emas.uk.com](http://www.emas.uk.com) | (+44) 01785 747 620

# Index

CONTROL UNITS AND PILOT LIGHTS	4
CONTROL BOXES	20
FOOT SWITCHES	24
LIMIT SWITCHES	26
SENSORS	36
BASIC SWITCHES	41
ROTARY CAM SWITCHES	47
INDUSTRIAL PLUGS & SOCKETS	56
SIGNALLING DEVICES	62
MOTOR PROTECTION CIRCUIT BREAKERS	67
LEVEL CONTROL FLOAT SWITCHES	70
CONTACTORS	72
INDUSTRIAL RELAYS & SOCKETS	75
ELECTRONIC PRODUCTS	77
SAFETY PRODUCTS	83
CRANE PRODUCTS	86
LIFT PRODUCTS	89
CABLE CARRIERS	92





BET60FLASH2



H060XK



BUSB30



H100S20



CP100FY



BRJ45



SCB22MP1NC1

# Control Units and Pilot Lights

## B Series Control Units, 22 mm, IP 50

### Flush, Spring Return



B100DY

Code	Contact Block Type	Colour*	Box/Pcs
B100D*	1 NO		10
B101D*	2 NO		10
B102D*	1 NO + 1 NC		10
B200D*	1 NC		10
B202D*	2 NC		10

### Stay-Put, Spring Return



B100FY

Code	Contact Block Type	Colour*	Box/Pcs
B100F*	1 NO		10
B200F*	1 NC		10

### Extended, Spring Return



B200HK

Code	Contact Block Type	Colour*	Box/Pcs
B100H*	1 NO		10
B101H*	2 NO		10
B102H*	1 NO + 1 NC		10
B200H*	1 NC		10
B202H*	2 NC		10

### Double, Spring Return



B132K21HB



B102K20KY

Code	Type	Contact Block Type	Colour*	Box/Pcs
B102K20KY		1 NO + 1 NC		8
B102K21KY	Extended	1 NO + 1 NC		8
B102K20HB		1 NO + 1 NC		8
B102K21HB	Extended	1 NO + 1 NC		8

### Big Size Double, Spring Return



B102B20KY

Code	Type	Contact Block Type	Colour*	Box/Pcs
B102B20HB	Flush	1 NO + 1 NC		8
B102B20KY	Flush	1 NO + 1 NC		8

### Triple With Extended Stop



B121B30YY

Code	Type	Contact Block Type	Colour*	Box/Pcs
B121B30YY	Extended Stop	1 NO + 1 NC + 1 NO		8
B121B30BB	Extended Stop	1 NO + 1 NC + 1 NO		8

### Selector



B100S20

Code	Type	Contact Block Type	Position	Angle	Colour*	Box/Pcs
B100S20		1 NO	0-1	60°		10
B100S21	Spring Return	1 NO	0-1	60°		10
B101S30		2 NO	II-0-1	60°		10
B101S31	Single Spring Return	2 NO	II-0-1	60°		10
B101S32	Double Spring Return	2 NO	II-0-1	60°		10
B100R20		1 NO	0-1	45°		10
B100R21	Spring Return	1 NO	0-1	45°		10
B100T20		1 NO	0-1	90°		10
B100T21	Spring Return	1 NO	0-1	90°		10

Note 1 : For "12-30V AC/DC" Voltage in LED illumination preferences, please use the numbers; 5: White, 6:Red, 7:Blue, 8: Yellow, 9: Green, instead of "0". i.e: B160SL20

Note 2 : For "48V AC/DC" Voltage in LED illumination preferences, please use the letters; Q: White, X:Red, V:Blue, W: Yellow, Z: Green, instead of "0".

Note 3 : For "100-230VAC" Voltage in LED illumination preferences, please use the letters; B: White, K:Red, M:Blue, S: Yellow, Y: Green, instead of "0". i.e: B1B0DB

Note 4 : For "110V AC/DC" Voltage in LED illumination preferences, please use the letters; C: White, D:Red, E:Blue, F: Yellow, G: Green, instead of "0".

Note 5 : Please use "3" instead of "0" for the Neon Lamp and Ba9S LED, please do not forget to add bulb



B100SL20Y

## Illuminated Selector

Code	Type	Contact Block Type	Position	Colour*	Box/Pcs
B100SL20*		1 NO	0-1		10
B100SL21*	Spring Return	1 NO	0-1		10
B101SL30*		2 NO	II-0-1		10
B101SL31*	Single Spring Return	2 NO	II-0-1		10
B101SL32*	Double Spring Return	2 NO	II-0-1		10

Note 1 : For "12-30V AC/DC" Voltage in LED illumination preferences, please use the numbers; 5: White, 6:Red, 7:Blue, 8: Yellow, 9: Green, instead of "0". i.e: B160SL20

Note 2 : For "48V AC/DC" Voltage in LED illumination preferences, please use the letters; Q: White, X:Red, V:Blue, W: Yellow, Z: Green, instead of "0".

Note 3 : For "100-230VAC" Voltage in LED illumination preferences, please use the letters; B: White, K:Red, M:Blue, S: Yellow, Y: Green, instead of "0". i.e: B1B0DB

Note 4 : For "110V AC/DC" Voltage in LED illumination preferences, please use the letters; C: White, D:Red, E:Blue, F: Yellow, G: Green, instead of "0".

Note 5 : Please use "3" instead of "0" for the Neon Lamp and Ba9S LED, please do not forget to add bulb



B200MK



B100C

## Handle and Mushroom Head

Code	Type	Contact Block Type	Colour*	Box/Pcs
B100C	Handle Switch	1 NO		10
B102C	Handle Switch	1 NO + 1 NC		10
B200C	Handle Switch	1 NC		10
B100M*	Mushroom Head, Spring Return	1 NO		10
B102M*	Mushroom Head, Spring Return	1 NO + 1 NC		10
B200M*	Mushroom Head, Spring Return	1 NC		10

\* Please choose the colour and replace (\*) with the letter.



B100AC20

## Key Operated

Code	Type	Contact Block Type	Position	Colour	Box/Pcs
B100AA20	Stay Put	1 NO	0-1		1
B102AA20	Stay Put	1 NO + 1 NC	0-1		1
B100AA21	Spring Return	1 NO	0-1		1
B101AA30	Stay Put	2 NO	II-0-1		1
B101AA31	Single Spring Return	2 NO	II-0-1		1
B101AA32	Double Spring Return	2 NO	II-0-1		1
B100AC20	Stay Put	1 NO	0-1		1
B102AC20	Stay Put	1 NO + 1 NC	0-1		1
B102AC30	Stay Put	1 NO + 1 NC	II-0-1		1

\* Ω Taking key out position



B200E30



B200EE



B200EG

## Emergency Stop

Code	Type	Contact Block Type	Diameter	Colour*	Box/Pcs
B200E30	Turn to Release	1 NC	30		10
B102E30	Turn to Release	1 NO + 1 NC	30		10
B102E	Turn to Release	1 NO + 1 NC	40		10
B200E	Turn to Release	1 NC	40		10
B200EE	With Label	1 NC	40		10
B200E60	Turn to Release	1 NC	60		5
B102E60	Turn to Release	1 NO + 1 NC	60		5
B200EG	With Position Cursor	1 NC	40		10



BPR01K

## Potentiometer (1,5W@70°C IP65)

Code	Features	Colour*	Box/Pcs
BPR01K	1 kΩ (Ceramic, Wired)		10
BPR02K	2,2 kΩ (Ceramic, Wired)		10
BPR05K	5 kΩ (Ceramic, Wired)		10
BPR10K	10 kΩ (Ceramic, Wired)		10
BPR100K	100 kΩ (Ceramic, Wired)		10



BUSB30



BRJ45



SCB22MP1NC1



B080XS

## Connection, IP65

Code	Features	Box/Pcs
BUSB	USB Connection, 1,50 Metre	1
BUSB30	Female-Female USB3.0 Connection	10
BRJ45	Female-Female Gold Plated Metal Ethernet Socket	10

## Touch Button, IP67

Code	Body Type	Voltage	Sensing Distance	Mounting	Housing Material	Connection	Output
SCB22MP1NC1	Dia 22 mm	10-30 V DC	Touch	Button	Plastic	1 Metre Cable	NPN-NO
SCB22MP1NSX	Dia 22 mm	10-30 V DC	Touch	Button	Plastic	M12 Connector	NPN-NO
SCB22MP1OC1	Dia 22 mm	10-30 V DC	Touch	Button	Plastic	1 Metre Cable	NPN-NC
SCB22MP1OSX	Dia 22 mm	10-30 V DC	Touch	Button	Plastic	M12 Connector	NPN-NC
SCB22MP1PC1	Dia 22 mm	10-30 V DC	Touch	Button	Plastic	1 Metre Cable	PNP-NO
SCB22MP1PSX	Dia 22 mm	10-30 V DC	Touch	Button	Plastic	M12 Connector	PNP-NO
SCB22MP1RC1	Dia 22 mm	10-30 V DC	Touch	Button	Plastic	1 Metre Cable	PNP-NC
SCB22MP1RSX	Dia 22 mm	10-30 V DC	Touch	Button	Plastic	M12 Connector	PNP-NC
SCB22MP5NC1	Dia 22 mm	10-30 V DC, Stay Put	Touch	Button	Plastic	1 Metre Cable	NPN-NO
SCB22MP5NSX	Dia 22 mm	10-30 V DC, Stay Put	Touch	Button	Plastic	M12 Connector	NPN-NO
SCB22MP5OC1	Dia 22 mm	10-30 V DC, Stay Put	Touch	Button	Plastic	1 Metre Cable	NPN-NC
SCB22MP5OSX	Dia 22 mm	10-30 V DC, Stay Put	Touch	Button	Plastic	M12 Connector	NPN-NC
SCB22MP5PC1	Dia 22 mm	10-30 V DC, Stay Put	Touch	Button	Plastic	1 Metre Cable	PNP-NO
SCB22MP5PSX	Dia 22 mm	10-30 V DC, Stay Put	Touch	Button	Plastic	M12 Connector	PNP-NO
SCB22MP5RC1	Dia 22 mm	10-30 V DC, Stay Put	Touch	Button	Plastic	1 Metre Cable	PNP-NC
SCB22MP5RSX	Dia 22 mm	10-30 V DC, Stay Put	Touch	Button	Plastic	M12 Connector	PNP-NC

## B Series Pilot Lights with Contact Block

Code	Illumination	Nominal Voltage	Colour*	Box/Pcs
B030X*	With Lampholder forBa9S		(B) (K) (M) (S) (Y)	10
B050XB	LED	12 - 30V AC/DC	(B)	10
B060XK	LED	12 - 30V AC/DC	(K)	10
B070XM	LED	12 - 30V AC/DC	(M)	10
B080XS	LED	12 - 30V AC/DC	(S)	10
B090XY	LED	12 - 30V AC/DC	(Y)	10
B0Q0XB	LED	48V AC/DC	(B)	10
B0V0XM	LED	48V AC/DC	(M)	10
B0W0XS	LED	48V AC/DC	(S)	10
B0X0XK	LED	48V AC/DC	(K)	10
B0Z0XY	LED	48V AC/DC	(Y)	10
B0B0XB	LED	100-230V AC	(B)	10
B0K0XK	LED	100-230V AC	(K)	10
B0M0XM	LED	100-230V AC	(M)	10
B0S0XS	LED	100-230V AC	(S)	10
B0Y0XY	LED	100-230V AC	(Y)	10
B0C0XB	LED	110V AC/DC	(B)	10
B0D0XK	LED	110V AC/DC	(K)	10
B0E0XM	LED	110V AC/DC	(M)	10
B0F0XS	LED	110V AC/DC	(S)	10
B0G0XY	LED	110V AC/DC	(Y)	10

Note: B030X\* doesn't have lamp. Please choose Ba9s LED from Page 8. \*Please choose the colour and replace (\*) with the letter.



B3



B1



BDDH



BDAA20



BDS20



BDK20KY



BDSL20Y



BDE60



BDC



BK



BDMH



BEBK20



BEB



LED220K



LED24S

## Spare Parts of B Series

Code	Type	Features	Position	Colour*	Box/Pcs
B1	Contact Block	1 NO			20
B2	Contact Block	1 NC			20
B3	Contact Block	Contact Block for Illumination			20
BDD*	Button Actuator	Flush		B K M S Y H	20
BDF*	Button Actuator	Stay Put		B K M S Y H	20
BDH*	Button Actuator	Extended		B K M S Y H	20
BDM*	Button Actuator	Mushroom		K S Y H	20
BDS20	Button Actuator	Selector	0-1		20
BDS21	Button Actuator	Selector, Spring Return	0-1		20
BDS30	Button Actuator	Selector	11-0-1		20
BDAC20	Button Actuator	Key Operated, Stay Put	0-1		10
BDAA20	Button Actuator	Key Operated, Stay Put	0-1		10
BDAC30	Button Actuator	Key Operated, Stay Put	11-0-1		10
BDAA30	Button Actuator	Key Operated, Stay Put	11-0-1		10
BDSL20*	Button Actuator	Illuminated Selector	0-1	B K M S Y H	20
BDSL30*	Button Actuator	Illuminated Selector	11-0-1	B K M S Y H	20
BDB20KY	Button Actuator	Big, Double			8
BDB30YY	Button Actuator	Double with Extended Stop Button			8
BDK20KY	Button Actuator	Double			8
BDK21KY	Button Actuator	Double, Extended			8
BDK20HB	Button Actuator	Double			8
BDK21HB	Button Actuator	Double, Extended			8
BDC	Button Actuator	Handle			20
BDE	Button Actuator	Emergency Stop, 40 mm			10
BDEE	Button Actuator	Emergency Stop, 40 mm, With Label			10
BDEG	Button Actuator	Emergency Stop, 40 mm With Position Cursor			10
BDE30	Button Actuator	Emergency Stop Cylindrical, 30 mm			10
BDE60	Button Actuator	Emergency Stop, 60 mm			5
TIPASOM	Stopper and Nut				500
BDX*	Pilot	Combination		B K M S Y H	20
B5	Illumination Block with LED	12-30V AC/DC			20
B6	Illumination Block with LED	12-30V AC/DC			20
B7	Illumination Block with LED	12-30V AC/DC			20
B8	Illumination Block with LED	12-30V AC/DC			20
B9	Illumination Block with LED	12-30V AC/DC			20
BB	Illumination Block with LED	100-230V AC			20
BK	Illumination Block with LED	100-230V AC			20
BM	Illumination Block with LED	100-230V AC			20
BS	Illumination Block with LED	100-230V AC			20
BY	Illumination Block with LED	100-230V AC			20
BC	Illumination Block with LED	110V AC/DC			20
BD	Illumination Block with LED	110V AC/DC			20
BE	Illumination Block with LED	110V AC/DC			20
BF	Illumination Block with LED	110V AC/DC			20
BG	Illumination Block with LED	110V AC/DC			20
BQ	Illumination Block with LED	48V AC/DC			20
BV	Illumination Block with LED	48V AC/DC			20
BW	Illumination Block with LED	48V AC/DC			20
BX	Illumination Block with LED	48V AC/DC			20
BZ	Illumination Block with LED	48V AC/DC			20
BA	Adapter				100
BEB	Silicon Cover	For Single Buttons			20
BEBK20	Silicon Cover	For Double Buttons			20
BEBK21	Silicon Cover	For Extended Double Buttons			20
LED24*	Ba9S LED	24 V AC/DC		B K M S Y	100
LED220*	Ba9S LED	220V AC		B K M S Y	100
BBUTONORTA	Contact Block Activator				50
BSECICIORTA	Contact Block Activator				50

\*Please choose the colour and replace (\*) with the letter.





CP100DY



CP200DK



CP305DY



CP100FK



CP100FY



CP100HK



CP102K20KY



CP100S20



CP100MY



CP200EA30



CP200EP



CP200EE

## CP Series Plastic Control Units, 22 mm, IP 65

### Flush, Spring Return

Code	Type	Contact Block Type	Colour*	Box/Pcs
CP100D*		1 NO		10
CP101D*		2 NO		10
CP102D*		1 NO + 1 NC		10
CP200D*		1 NC		10
CP202D*		2 NC		10
CP303D*		2 NO + 2 NO		5
CP305D*		2 NO + 2 NC		5

### Stay Put, Spring Return

Code	Contact Block Type	Colour*	Box/Pcs
CP100F*	1 NO		10
CP200F*	1 NC		10

### Extended, Spring Return

Code	Contact Block Type	Colour*	Box/Pcs
CP100H*	1 NO		10
CP101H*	2 NO		10
CP102H*	1 NO + 1 NC		10
CP200H*	1 NC		10
CP202H*	2 NC		10

### Double, Spring Return

Code	Type	Contact Block Type	Colour*	Box/Pcs
CP102K20KY		1 NO + 1 NC		8
CP102K20HB		1 NO + 1 NC		8
CP102K21KY	Extended	1 NO + 1 NC		8
CP102K21HB	Extended	1 NO + 1 NC		8

### Selector

Code	Type	Contact Block Type	Position	Colour*	Box/Pcs
CP100S20		1 NO	0-1 ↓		10
CP100S21	Spring Return	1 NO	0-1 ↓		10
CP101S30		2 NO	II-0-1 ↓		10
CP303S30		2 NO + 2 NO	II-0-1 ↓		5
CP305S30		2 NO + 2 NC	II-0-1 ↓		5
CP101S31	Single Spring Return	2 NO	II-0-1 ↓		10
CP101S32	Double Spring Return	2 NO	II-0-1 ↓		10

### Mushroom, Spring Return

Code	Type	Contact Block Type	Colour*	Box/Pcs
CP100M*	Mushroom, Spring Return	1 NO		10
CP102M*	Mushroom, Spring Return	1NO + 1NC		10
CP200M*	Mushroom, Spring Return	1 NC		10

### Emergency Stop

Code	Type	Contact Block Type	Dia (mm)	Colour*	Box/Pcs
CP200E30	Turn to Release	1 NC	30		10
CP200ES30	With Signal	1 NC	30		10
CP200EA30	Key Operated	1 NC	30		10
CP200ECN30	Pull to Release	1 NC	30		10
CP200ECS30	With Signal, Pull to Release	1 NC	30		10
CP200E	Turn to Release	1 NC	40		10
CP200EP	With Window, Pull to Release	1 NC	40		10
CP200EE	With Label	1 NC	40		10
CP200EK30	Turn to Release-Short	1 NC	30		10
CP200EC	Pull to Release	1 NC	40		10

Note 1 : For "12-30V AC/DC" Voltage in LED illumination preferences, please use the numbers; 5: White, 6:Red, 7:Blue, 8: Yellow, 9: Green, instead of "0". i.e: B160SL20

Note 2 : For "48V AC/DC" Voltage in LED illumination preferences, please use the letters; Q: White, X:Red, V:Blue, W: Yellow, Z: Green, instead of "0".

Note 3 : For "100-230VAC" Voltage in LED illumination preferences, please use the letters; B: White, K:Red, M:Blue, S: Yellow, Y: Green, instead of "0". i.e: B1B0DB

Note 4 : For "110V AC/DC" Voltage in LED illumination preferences, please use the letters; C: White, D:Red, E:Blue, F: Yellow, G: Green, instead of "0".



CP100AC20



CP707DJ40

NEW



CPPR02K

NEW



CPPR05K



CP060XK

## Key Operated

Code	Type	Contact Block Type	Position	Colour	Box/Pcs
CP100AA20		1 NO	0-1	●	10
CP101AA21	Spring Return	2 NO	0-1	●	10
CP102AA30		1 NO + 1 NC	II-0-1	●	10
CP101AA31	Single Spring Return	2 NO	II-0-1	●	10
CP101AA32	Double Spring Return	2 NO	II-0-1	●	10
CP100AC20		1 NO	0-1	●	10
CP102AC30		1 NO + 1 NC	II-0-1	●	10

\* Ω Taking key out position

## Joystick

Code	Type	Position	Colour	Box/Pcs
CP101DJ20		2 Pos.	●	1
CP101DJ21	Spring Return	2 Pos.	●	1
CP707DJ40		4 Pos.	●	1
CP707DJ41	Spring Return	4 Pos.	●	1

## Potentiometer (1,5W@70°C IP65)

Code	Features	Colour	Box/Pcs
CPPR01K	1 kΩ (Ceramic, Wired)	●	10
CPPR02K	2,2 kΩ (Ceramic, Wired)	●	10
CPPR05K	5 kΩ (Ceramic, Wired)	●	10
CPPR10K	10 kΩ (Ceramic, Wired)	●	10
CPPR100K	100 kΩ (Ceramic, Wired)	●	10

## CP Series Pilot Lights with Lamp Block

Code	Illumination	Nominal Voltage	Colour	Box/Pcs
CP050XB	LED	12 - 30V AC/DC	○	10
CP060XK	LED	12 - 30V AC/DC	●	10
CP070XM	LED	12 - 30V AC/DC	●	10
CP080XS	LED	12 - 30V AC/DC	●	10
CP090XY	LED	12 - 30V AC/DC	●	10
CP0Q0XB	LED	48V AC/DC	○	10
CP0V0XM	LED	48V AC/DC	●	10
CP0W0XS	LED	48V AC/DC	●	10
CP0X0XK	LED	48V AC/DC	●	10
CP0Z0XY	LED	48V AC/DC	●	10
CP0B0XB	LED	100-230V AC	○	10
CP0K0XK	LED	100-230V AC	●	10
CP0M0XM	LED	100-230V AC	●	10
CP0S0XS	LED	100-230V AC	●	10
CP0Y0XY	LED	100-230V AC	●	10
CP0C0XB	LED	110V AC/DC	○	10
CP0D0XK	LED	110V AC/DC	●	10
CP0E0XM	LED	110V AC/DC	●	10
CP0F0XS	LED	110V AC/DC	●	10
CP0G0XY	LED	110V AC/DC	●	10
CP0N0XB	LED	220V DC	○	10
CP0O0XK	LED	220V DC	●	10
CP0P0XM	LED	220V DC	●	10
CP0R0XS	LED	220V DC	●	10
CP0T0XY	LED	220V DC	●	10

## CM Series Metal Control Units, 22 mm, IP 65

### Flush, Spring Return

Code	Type	Contact Block Type	Colour	Box/Pcs
CM100D*		1 NO	B K M S Y H	10
CM101D*		2 NO	B K M S Y H	10
CM102D*		1 NO + 1 NC	B K M S Y H	10
CM200D*		1 NC	B K M S Y H	10
CM202D*		2 NC	B K M S Y H	10
CM305D*		2 NO + 2 NC	B K M S Y H	5

\* Please choose the colour and replace (\*) with the letter.



CM100DY



CM200DK



CM100HY

## Extended, Spring Return

Code	Contact Block Type	Colour*	Box/Pcs
CM100H*	1 NO		10
CM101H*	2 NO		10
CM102H*	1 NO + 1 NC		10
CM200H*	1 NC		10
CM202H*	2 NC		10



CM102K21KY



CM102K20KY

## Double, Spring Return

Code	Type	Contact Block Type	Colour	Box/Pcs
CM102K20KY		1 NO + 1 NC		8
CM102K20HB		1 NO + 1 NC		8
CM102K21KY	Double Extended	1 NO + 1 NC		8
CM102K21HB	Double Extended	1 NO + 1 NC		8



CM100S20

## Selector

Code	Type	Contact Block Type	Position	Colour	Box/Pcs
CM100S20		1 NO	0-1 ↓		10
CM100S21	Spring Return	1 NO	0-1 ↓		10
CM101S30		2 NO	II-0-1 ↓		10
CM303S30		2 NO + 2 NO	II-0-1 ↓		5
CM101S31	Single Spring Return	2 NO	II-0-1 ↓		10
CM101S32	Double Spring Return	2 NO	II-0-1 ↓		10

Note 1 : For "12-30V AC/DC" Voltage in LED illumination preferences, please use the numbers; 5: White, 6:Red, 7:Blue, 8: Yellow, 9: Green, instead of "0". i.e: B160SL20

Note 2 : For "48V AC/DC" Voltage in LED illumination preferences, please use the letters; Q: White, X:Red, V:Blue, W: Yellow, Z: Green, instead of "0".

Note 3 : For "100-230VAC" Voltage in LED illumination preferences, please use the letters; B: White, K:Red, M:Blue, S: Yellow, Y: Green, instead of "0". i.e: B1B0DB

Note 4 : For "110V AC/DC" Voltage in LED illumination preferences, please use the letters; C: White, D:Red, E:Blue, F: Yellow, G: Green, instead of "0".



CM100MY

## Mushroom, Spring Return

Code	Type	Contact Block Type	Colour*	Box/Pcs
CM100M*	Mushroom, Spring Return	1 NO		10
CM102M*	Mushroom, Spring Return	1NO + 1NC		10
CM200M*	Mushroom, Spring Return	1 NC		10



CM200E



CM200EE

## Emergency Stop

Code	Type	Contact Block Type	Dia (mm)	Colour	Box/Pcs
CM200E	Turn to Release	1 NC	40		10
CM200EE	Turn to Release, With Label	1 NC	40		10
CM200EK30	Short, Turn to Release	1 NC	30		10



CM100AC20

## Key Operated

Code	Type	Contact Block Type	Position	Colour	Box/Pcs
CM100AA20		1 NO	0-1 ↓		10
CM100AA21	Spring Return	1 NO	0-1 ↓		10
CM102AA30		1 NO + 1 NC	II-0-1 ↓		10
CM101AA31	Single Spring Return	2 NO	II-0-1 ↓		10
CM101AA32	Double Spring Return	2 NO	II-0-1 ↓		10
CM102AA20		1 NO + 1 NC	0-1 ↓		10
CM100AC20		1 NO	0-1 ↓		10
CM102AC20		1 NO + 1 NC	0-1 ↓		10
CM102AC30		1 NO + 1 NC	II-0-1 ↓		10

\* Ω Taking key out position



CM707DJ40

## Joystick

Code	Type	Position	Colour	Box/Pcs
CM101DJ20		2 Pos.		1
CM101DJ21	Spring Return	2 Pos.		1
CM707DJ40		4 Pos.		1
CM707DJ41	Spring Return	4 Pos.		1





CM090XY

## CM Series Pilot Lights with Lamp Block

Code	Illumination	Nominal Voltage	Colour	Box/Pcs
CM050XB	LED	12 - 30V AC/DC	White	10
CM060XK	LED	12 - 30V AC/DC	Red	10
CM070XM	LED	12 - 30V AC/DC	Blue	10
CM080XS	LED	12 - 30V AC/DC	Yellow	10
CM090XY	LED	12 - 30V AC/DC	Green	10
CM0Q0XB	LED	48V AC/DC	White	10
CM0V0XM	LED	48V AC/DC	Blue	10
CM0W0XS	LED	48V AC/DC	Yellow	10
CM0X0XK	LED	48V AC/DC	Red	10
CM0Z0XY	LED	48V AC/DC	Green	10
CM0B0XB	LED	100-230V AC	White	10
CM0K0XK	LED	100-230V AC	Red	10
CM0M0XM	LED	100-230V AC	Blue	10
CM0S0XS	LED	100-230V AC	Yellow	10
CM0Y0XY	LED	100-230V AC	Green	10
CM0C0XB	LED	110V AC/DC	White	10
CM0D0XK	LED	110V AC/DC	Red	10
CM0E0XM	LED	110V AC/DC	Blue	10
CM0F0XS	LED	110V AC/DC	Yellow	10
CM0G0XY	LED	110V AC/DC	Green	10
CM0N0XB	LED	220V DC	White	10
CM0O0XK	LED	220V DC	Red	10
CM0P0XM	LED	220V DC	Blue	10
CM0R0XS	LED	220V DC	Yellow	10
CM0T0XY	LED	220V DC	Green	10



C1



C2



C3BK



C3CK



C4BK



C4CK



C12



CPDXK



CPDDY



CPDS20

## Spare Parts for CP/CM Series Control Units

Code	Type	Features	Colour	Box/Pcs
C1	Contact Block	1 NO	Black	20
C2	Contact Block	1 NC	Black	20
C1AU	Gold Plated Contact Block	1 NO	Black	20
C2AU	Gold Plated Contact Block	1 NC	Black	20
C12	Joystick Contact Block	2 NO	Black	20
C3BK	Contact Block for Control Boxes (B Series)	1 NO	Black	20
C4BK	Contact Block for Control Boxes (B Series)	1 NC	Black	20
C3CK	Contact Block for Control Boxes (C Series)	1 NO	Black	20
C4CK	Contact Block for Control Boxes (C Series)	1 NC	Black	20
CPDD*	Plastic, Flush	IP65	B K M S Y H	20
CPDF*	Plastic, Stay Put	IP65	B K M S Y H	20
CPDH*	Plastic-Extended	IP65	B K M S Y H	20
CPDM*	Plastic, Mushroom	IP65	K S Y H	20
CPDM72*	Plastic, Mushroom	IP65	K H	20
CPDS20	Selector - Plastic	IP65	Black	20
CPDS30	Selector - Plastic	IP65	Black	20
CPDX*	Pilot - Plastic	IP65	B K M S Y	20
CPDE30	Emergency Stop Head	IP65 - Turn to Release	Red	20
CPDEA30	Emergency Stop Head	IP65 - Key Operated	Red	20
CPDECN30	Emergency Stop Head	IP65 - Pull to Release	Red	20
CPDES30	Emergency Stop Head	IP65 - With Signal	Red	20
CMDD*	Metal-Flush	IP65	B K M S Y H	20
CMDH*	Metal-Extended	IP65	B K M S Y H	20
CMDM*	Metal, Mushroom	IP65	K S Y H	20
CMDS20	Selector - Metal	IP65	Black	20
CMDS30	Selector - Metal	IP65	Black	20
CMDX*	Pilot - Metal	IP65	B K M S Y	20

\* Please choose the colour and replace (\*) with the letter. Example: CMDXY.



CBB



CPDXK



CA

## For Control Units / For Control Boxes

Code	Type	Features	Colour	Box/Pcs
CB5 / CK5	Illumination Block with LED	12-30V AC/DC	○	20
CB6 / CK6	Illumination Block with LED	12-30V AC/DC	●	20
CB7 / CK7	Illumination Block with LED	12-30V AC/DC	●	20
CB8 / CK8	Illumination Block with LED	12-30V AC/DC	●	20
CB9 / CK9	Illumination Block with LED	12-30V AC/DC	●	20
CBB / CKB	Illumination Block with LED	100-230V AC	○	20
CBK / CKK	Illumination Block with LED	100-230V AC	●	20
CBM / CKM	Illumination Block with LED	100-230V AC	●	20
CBS / CKS	Illumination Block with LED	100-230V AC	●	20
CBY / CKY	Illumination Block with LED	100-230V AC	●	20
CBQ / CKQ	Illumination Block with LED	48V AC/DC	○	20
CBV / CKV	Illumination Block with LED	48V AC/DC	●	20
CBW / CKW	Illumination Block with LED	48V AC/DC	●	20
CBX / CKX	Illumination Block with LED	48V AC/DC	●	20
CBZ / CKZ	Illumination Block with LED	48V AC/DC	●	20
CBC / CKC	Illumination Block with LED	110V AC/DC	○	20
CBD / CKD	Illumination Block with LED	110V AC/DC	●	20
CBE / CKE	Illumination Block with LED	110V AC/DC	●	20
CBF / CKF	Illumination Block with LED	110V AC/DC	●	20
CBG / CKG	Illumination Block with LED	110V AC/DC	●	20
CBN	Illumination Block with LED	220V DC	○	20
CBO	Illumination Block with LED	220V DC	●	20
CBP	Illumination Block with LED	220V DC	●	20
CBR	Illumination Block with LED	220V DC	●	20
CBT	Illumination Block with LED	220V DC	●	20
CA	Adapter			20
CEA	Additional Adapter			10

## Pad Printed Control Units ( matt surface without Illumination )

Code	B102K20KY10	B101K20YY12	B101K20YYOK	B102K20HB10	B101K20HHOK	B101K20BB12	B101K20SH10	B101K20SS12
	CP102K20KY10	CP101K20YY12	CP101K20YYOK	CP102K20HB10	CP101K20HHOK	CP101K20BB12	CP101K20SH10	CP101K20SS12
PRINT	CM102K20KY10	CM101K20YY12	CM101K20YYOK	CM102K20HB10	CM101K20HHOK	CM101K20BB12	CM101K20SH10	CM101K20SS12
	I-O	I-II	Arrow Signed	I-O	Arrow Signed	I-II	I-O	I-II
Code	B100DY0D	B100DY0Y	B100DH0D	B100DH0Y	B100DB0D	B100DB0Y	B100DBZ	B100DBL
	CP100DY0D	CP100DY0Y	CP100DH0D	CP100DH0Y	CP100DB0D	CP100DB0Y	CP100DBZ	CP100DBL
	CM100DY0D	CM100DY0Y	CM100DH0D	CM100DH0Y	CM100DB0D	CM100DB0Y	CM100DBZ	CM100DBL
PRINT	MB100DY0D	MB100DY0Y	MB100DH0D	MB100DH0Y	MB100DB0D	MB100DB0Y	MB100DBZ	MB100DBL
	Vertical Arrow	Horizontal Arrow	Vertical Arrow	Horizontal Arrow	Vertical Arrow	Horizontal Arrow	Bell	Lamp
Code	B100DY1	B100DY2	B100DB1	B100DB2	B200DK0	B200DH0	B200DSZ	B200DSL
	CP100DY1	CP100DY2	CP100DB1	CP100DB2	CP200DK0	CP200DH0	CP200DSZ	CP200DSL
	CM100DY1	CM100DY2	CM100DB1	CM100DB2	CM200DK0	CM200DH0	CM200DSZ	CM200DSL
PRINT	MB100DY1	MB100DY2	MB100DB1	MB100DB2	MB200DK0	MB200DH0	MB200DSZ	MB200DSL
	I	II	I	II	0	0	Bell	Lamp

Note : Minimum Order Quantity : 50 pcs

## Accessories for B and C Series Control Units

Code	Type	Features	Position	Box/Pcs
BROZET08	Legend Plate Holder	8 mm.		100
BROZET18	Legend Plate Holder	18 mm.		100
BCIFTLIROZET18	Double Legend Plate Holder	18 mm.		100
BET08	Unmarked Legend Plate	8 mm. Empty		100
BET18	Unmarked Legend Plate	18 mm. Empty		100
BET08START	Marked Legend Plate	8 mm. Start		100
BET08STOP	Marked Legend Plate	8 mm. Stop		100
BET0801	Marked Legend Plate	8 mm.	0-1	100
BET0801OK	Marked Legend Plate	8 mm.	0-1	100
BET08201	Marked Legend Plate	8 mm.	II-0-I	100
BET08201OK	Marked Legend Plate	8 mm.	I-0-I	100
BET08201OK2	Marked Legend Plate	8 mm.	I-0-I	10
BET080	Unmarked Legend Plate, Transparent	8 mm.		100
BET180	Unmarked Legend Plate, Transparent	18 mm.		100
BET60P	Emergency Marked Legend Plate, Plastic	60 mm. Emergency Stop		10
BET90P	Emergency Marked Legend Plate, Plastic	90 mm. Emergency Stop		10
BET60A	Emergency Marked Legend Plate, Aluminium	60 mm. Emergency Stop		10
BET90A	Emergency Marked Legend Plate, Aluminium	90 mm. Emergency Stop		10
BET60LED2	Emergency Marked Legend Plate, Plastic, with LED, ENG, ENG	60 mm. Emergency Stop-24V AC/DC		1
BET60FLASH2	Emergency Marked Legend Plate, Plastic ENG, ENG	60mm Flash 24V AC/DC		1
BMUHAFAZA	Emergency Protective Cover	Protection Guard		20
CMUHAFAZA	Emergency Protective Cover	Protection Guard		20
BPUL	Plate	Button Tightening		100
TIPASOM	Stopper and Nut	2 Options Black and Gray		20
BEB	Silicon Cover	For Single Buttons		20
BEBK20	Silicon Cover	For Double Buttons		20
BEBK21	Silicon Cover	For Extended Double Buttons		20
BPROT	Protective Cover			20
BSOMAN	Nut Tightener			10
BARP	DIN Rail Adapter for M22 Control Units			
EMNKAPAK	Emergency Cover			



BET08201OK2



BET08201OK



BET08



BET18

START

BET08START

STOP

BET08STOP

0 1

BET0801

0-1

BET0801OK

II 0 I

BET08201





D100DDY

## D Series Control Units, 16 mm, IP 50

### Rectangle, Spring Return

Code	Contact Block Type	Colour*	Box/Pcs
D100DD*	1 NO		10
D101DD*	2 NO		10
D102DD*	1 NO + 1 NC		10
D200DD*	1 NC		10
D202DD*	2 NC		10



D200KDK

### Square, Spring Return

Code	Contact Block Type	Colour*	Box/Pcs
D100KD*	1 NO		10
D101KD*	2 NO		10
D102KD*	1 NO + 1 NC		10
D200KD*	1 NC		10
D202KD*	2 NC		10



D200YDK

### Round, Spring Return

Code	Contact Block Type	Colour*	Box/Pcs
D100YD*	1 NO		10
D101YD*	2 NO		10
D102YD*	1 NO + 1 NC		10
D200YD*	1 NC		10
D202YD*	2 NC		10

Note 1 : For "12-30V AC/DC" Voltage in LED illumination preferences, please use the numbers; 5: White, 6:Red, 7:Blue, 8: Yellow, 9: Green, instead of "0". i.e: B160SL20



D101YS30

### Round, Selector

Code	Type	Contact Block Type	Position	Colour	Box/Pcs
D100YS20		1 NO	0-I		10
D100YS21	Spring Return	1 NO	0-I		10
D101YS30		2 NO	II-0-I		10
D101YS31	Single Spring Return	2 NO	II-0-I		10
D101YS32	Double Spring Return	2 NO	II-0-I		10



D100YM30K

### Mushroom, Spring Return

Code	Contact Block Type	Colour*	Box/Pcs
D100YM30*	1 NO		10
D102YM30*	1 NO + 1 NC		10
D200YM30*	1 NC		10



D200YE30K

### Emergency Stop

Code	Contact Block Type	Colour*	Box/Pcs
D100YE30K	1 NO		10
D102YE30K	1 NO + 1 NC		10
D200YE30K	1 NC		10



D1



D2



D9

### Spare Parts for D Series Control Units

Code	Contact Block Type	Colour*	Box/Pcs
D1	1 NO		10
D2	1 NC		10
D5**	-		10
D6**	-		10
D7**	-		10
D8**	-		10
D9**	-		10
DA	Button Adapter		10

\* (\*\* ) 24V AC/DC LED.



D060DXK



D080KXS

## D Series 16 mm Pilot Lights

Code	Pilot Shape	Illumination	Nominal Voltage	Colour	Box/Pcs
D050DXB	Rectangle	LED	12-24V AC/DC	○	10
D060DXK	Rectangle	LED	12-24V AC/DC	●	10
D070DXM	Rectangle	LED	12-24V AC/DC	●	10
D080DXS	Rectangle	LED	12-24V AC/DC	●	10
D090DXY	Rectangle	LED	12-24V AC/DC	●	10
D050KXB	Square	LED	12-24V AC/DC	○	10
D060KXK	Square	LED	12-24V AC/DC	●	10
D070KXM	Square	LED	12-24V AC/DC	●	10
D080KXS	Square	LED	12-24V AC/DC	●	10
D090KXY	Square	LED	12-24V AC/DC	●	10
D050YXB	Round	LED	12-24V AC/DC	○	10
D060YXK	Round	LED	12-24V AC/DC	●	10
D070YXM	Round	LED	12-24V AC/DC	●	10
D080YXS	Round	LED	12-24V AC/DC	●	10
D090YXY	Round	LED	12-24V AC/DC	●	10

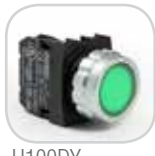

H100DY



H200DK

## H Series Control Units, 30 mm, IP 50

### Flush, Spring Return

Code	Contact Block Type	Colour*	Box/Pcs
H100D*	1 NO	ⓑ Ⓚ Ⓜ Ⓢ Ⓨ ⓗ	10
H101D*	2 NO	ⓑ Ⓚ Ⓜ Ⓢ Ⓨ ⓗ	10
H102D*	1 NO + 1 NC	ⓑ Ⓚ Ⓜ Ⓢ Ⓨ ⓗ	10
H200D*	1 NC	ⓑ Ⓚ Ⓜ Ⓢ Ⓨ ⓗ	10
H202D*	2 NC	ⓑ Ⓚ Ⓜ Ⓢ Ⓨ ⓗ	10

Spare Parts: Use Contact Blocks and Illumination Contact Blocks from B Series.



H100HY



H102HS

### Extended, Spring Return

Code	Contact Block Type	Colour	Box/Pcs
H100H*	1 NO	ⓑ Ⓚ Ⓜ Ⓢ Ⓨ ⓗ	10
H101H*	2NO	ⓑ Ⓚ Ⓜ Ⓢ Ⓨ ⓗ	10
H102H*	1NO + 1 NC	ⓑ Ⓚ Ⓜ Ⓢ Ⓨ ⓗ	10
H200H*	1 NC	ⓑ Ⓚ Ⓜ Ⓢ Ⓨ ⓗ	10
H202H*	2 NC	ⓑ Ⓚ Ⓜ Ⓢ Ⓨ ⓗ	10



H100MS

### Mushroom, Spring Return

Code	Contact Block Type	Colour*	Box/Pcs
H100M*	1 NO	Ⓚ Ⓢ Ⓨ ⓗ	10
H200M*	1 NC	Ⓚ Ⓢ Ⓨ ⓗ	10
H102M*	1 NO + 1 NC	Ⓚ Ⓢ Ⓨ ⓗ	10



H100S20



H101S30

### Selector

Code	Type	Contact Block Type	Position	Degree	Colour	Box/Pcs
H100S20		1NO	0-I	60	ⓗ	10
H100S21	Spring Return	1NO	0-I	60	ⓗ	10
H101S30		2NO	II-0-I	60	ⓗ	10
H101S31	Single Spring Return	2NO	II-0-I	60	ⓗ	10
H101S32	Double Spring Return	2NO	II-0-I	60	ⓗ	10



H200EE

### Emergency Stop

Code	Type	Contact Block Type	Colour*	Box/Pcs
H200E	Turn to Release	1 NC	Ⓚ	10
H200EE	Turn to Release with Label	1 NC	Ⓚ	10



H060XK

### H Series Pilot Lights

Code	Illumination	Nominal Voltage	Colour	Box/Pcs
H030X*	With Lampholder for BA9S		Ⓚ Ⓢ Ⓨ	10
H050XB	LED	12-30V AC/DC	ⓑ	10
H060XK	LED	12-30V AC/DC	Ⓚ	10
H070XM	LED	12-30V AC/DC	Ⓜ	10
H080XS	LED	12-30V AC/DC	Ⓢ	10
H090XY	LED	12-30V AC/DC	Ⓨ	10



KB34DY



KB14RS-0

## KB Series Control Units, 22 mm, IP 40

### Flush, Spring Return

Code	Type	Contact Block Type	Colour	Box/Pcs
KB12D*		1 NC	(B) (K) (M) (S) (Y)	10
KB34D*		1 NO	(B) (K) (M) (S) (Y)	10
KB14D*		1 NC + 1 NO	(B) (K) (M) (S) (Y)	10
KB12R*	With Silicon Cover	1 NC	(B) (K) (M) (S) (Y)	10
KB34R*	With Silicon Cover	1 NO	(B) (K) (M) (S) (Y)	10
KB14R*	With Silicon Cover	1 NC + 1 NO	(B) (K) (M) (S) (Y)	10
KB14R*0	With Silicon Cover, With Arrow	1 NC + 1 NO	(B) (K) (M) (S) (Y)	10
KB34R*0	With Silicon Cover, With Arrow	1 NO	(B) (K) (M) (S) (Y)	10
KB12R*0	With Silicon Cover, With Arrow	1 NC	(B) (K) (M) (S) (Y)	10



KB34S2

### Selector

Code	Contact Block Type	Colour	Box/Pcs
KB34S2	1 NO	(Black)	10
KB14S2	1 NO + 1 NC	(Black)	10



KB12C

### Handle

Code	Contact Block Type	Colour	Box/Pcs
KB12C	1 NC	(B)	10
KB34C	1 NO	(B)	10
KB14C	1 NO + 1 NC	(B)	10



KB14A2

### Key Operated

Code	Contact Block	Colour	Box/Pcs
KB14A2	1 NO + 1 NC	(Black)	1



KB12MK

### Mushroom

Code	Contact Block	Colour	Box/Pcs
KB12M*	1 NC	(K) (S) (Y)	10
KB34M*	1 NO	(K) (S) (Y)	10
KB14M*	1 NO + 1 NC	(K) (S) (Y)	10



KB12E

### Emergency Stop

Code	Type	Contact Block	Colour	Box/Pcs
KB12E	Turn to Release	1 NC	(Red)	10
KB14E	Turn to Release	1 NO + 1 NC	(Red)	10



KB12

### Spare Parts for KB Series Control Units

Code	Type	Contact Block	Colour	Box/Pcs
KB12	Contact Block	1 NC		100
KB34B	Contact Block	1 NO		100
KB14B	Contact Block, For Push Button	1 NO + 1 NC		100
KB14K	Contact Block, For Box	1 NO + 1 NC		100
D*	Button Head		(B) (K) (M) (S) (Y)	100

\*Please choose the colour and replace (\*) with the letter.



## MB Series Monoblock Control Units, 22 mm, IP 50

### Flush, Spring Return



MB102DM



MB100DY

Code	Contact Block	Colour	Box/Pcs
MB100D*	1 NO		10
MB102D*	1 NO + 1 NC		10
MB200D*	1 NC		10
MB101D*	2 NO		10
MB202D*	2 NC		10

### Stay-Put, Spring Return



MB100FY

Code	Contact Block	Colour	Box/Pcs
MB100F*	1 NO		10
MB200F*	1 NC		10
MB101F*	2 NO		10
MB102F*	1 NO + 1 NC		10

### Extended, Spring Return



MB100HY

Code	Contact Block	Colour	Box/Pcs
MB100H*	1 NO		10
MB101H*	2 NO		10
MB102H*	1 NO + 1 NC		10
MB200H*	1 NC		10
MB202H*	2 NC		10

### Selector



MB100S20

Code	Type	Contact Block	Position	Degree	Colour	Box/Pcs
MB100S20		1 NO	0-1	60°		10
MB100S21	Spring Return	1 NO	0-1	60°		10
MB101S30		2 NO	II-0-1	60°		10
MB101S31	Single Spring Return	2 NO	II-0-1	60°		10
MB101S32	Double Spring Return	2 NO	II-0-1	60°		10

### Emergency Stop



MB200E



MB200EE

Code	Type	Contact Block	Diameter	Colour	Box/Pcs
MB200E	Turn to Release	1 NC	40		10
MB200EE	With Label	1 NC	40		10

### Mushroom Head



MB200MK

Code	Contact Block Type	Colour	Box/Pcs
MB100M*	1 NO		10
MB101M*	2 NO		10
MB102M*	1 NO + 1 NC		10
MB200M*	1 NC		10
MB202M*	2 NC		10

### Monoblock Pilot Lights (LED) IP54



MBSD024Y



MBSP220M



MBSP110K

Code	Features	Nominal Voltage	Colour	Box/Pcs
MBSD012*	Flat	12V AC/DC		10
MBSD024*	Flat	24V AC/DC		10
MBSD110*	Flat	110V AC		10
MBSD220*	Flat	220V AC		10
MBSP012*	Cellular	12V AC/DC		10
MBSP024*	Cellular	24V AC/DC		10
MBSP110*	Cellular	110V AC		10
MBSP220*	Cellular	220V AC		10

• Please choose the colour and replace (\*) with the letter.



MBZS024S



MBZX220S

## Monoblock Buzzers

### MB Series Ø 22 mm Monoblock Buzzer Pilot Types (LED), 90 db (10 cm Distance)

Code	Features	Nominal Voltage	Box/Pcs
MBZS012S	With LED Illumination	12V AC/DC	10
MBZS024S	With LED Illumination	24V AC/DC	10
MBZS110S	With LED Illumination	110V AC	10
MBZS220S	With LED Illumination	220V AC	10
MBZX012S		12V AC/DC	10
MBZX024S		24V AC/DC	10
MBZX110S		110V AC	10
MBZX220S		220V AC	10

Note: For IP65 preferences, please add "E" letter to end of the code.  
In case of IP65 preferences, volume will be decreased 5 db.



S100LK



S102NS



S140NK



S224NB



S140NY2



S222LS

## Pilot Lights

Code	Dia (mm)	Illumination	Features	Voltage	Colour	Box/Pcs
S100N*	10	Bulb	12cm Cable	230V AC	B K M S Y	100
S100L*	10	LED	12cm Cable	230V AC	B K M S Y	100
S100L*1	10	LED	12cm Cable	12V AC/DC	B K M S Y	100
S100L*2	10	LED	12cm Cable	24V AC/DC	B K M S Y	100
S100N*5SP0	10	Bulb	12cm, With Silicon Cable	230V AC	B K M S Y	100
S102N*	10	Bulb	With Terminal	230V AC	B K M S Y	50
S105N*	10	Bulb	Nutless	230V AC	B K M S Y	50
S106N*	10	Bulb	12cm Cable	230V AC	B K M S Y	100
S140N*	14	Bulb		230V AC	B K M S Y	50
S140N*1	14	Bulb		12V DC	B K M S Y	50
S140N*2	14	Bulb		24V DC	B K M S Y	50
S145N*	14	Bulb	Hooked	230V AC	B K M S Y	50
S220N*	22	Bulb	Conic Glass	230V	B K M S Y	20
S220N*6	22	With Lampholder	Conic Glass		B K M S Y	20
S222N*	22	Bulb	Finger Proof	230V AC	B K M S Y	20
S222L*	22	LED	Finger Proof	230V AC	B K M S Y	20
S222L1*	22	LED	Finger Proof	12V AC/DC	B K M S Y	20
S222L2*	22	LED	Finger Proof	24V AC/DC	B K M S Y	20
S224N*	22	Bulb	Terminal + Screw	230V AC	B K M S Y	10
S224N*7	22	With Ba9S Lampholder	Terminal + Screw		B K M S Y	20

\*Please choose the colour and replace (\*) with the letter.

Note: S1450 ve S2200 Signal Lamps are transparent.



PDA



NA201Y

## Spare Parts

Code	Illumination	Features	Voltage	Colour	Box/Pcs
PDA	Bulb with Plastic Lampholder		230V	○	100
NA201Y	Neon Bulb	Rotat. Mount., Green	230V	●	100
NA201	Neon Bulb	Rotational Mounting	230V	○	100
NA101	Neon Bulb	Screw Mounting	230V	○	100
NA202	Filament Bulb	Bayonet Socket	24V AC/DC		100



P1EC400E40L

## Control Boxes



P1C300M72H



P1C400DK



P1C400E72



P1C300DY



P3EC1A2BE30



P1EC400E40K



P1EBOS



P2AB



M1C200E40



PY1BOS



PK1SE



PK2



PK3



PK31S

## P Series (IP65 With Suitable Buttons, Plastic Enclosed)

Code	Button Qty	Features	Box Colour	Box/Pcs
P1C300M72H	1	72 mm Mushroom Button (Black Button) (Start)	Black-Grey	1
P1C400M72	1	72mm. Mushroom (Red Button)(Stop)	Black-Grey	1
<b>P1C400E72</b>	<b>1</b>	<b>72mm. Emergency Stop</b>	<b>Black-Grey</b>	<b>1</b>
P1C300DY	1	Green	Black-Grey	1
P1C400DK	1	Red	Black-Grey	1
P1C304DK	1	Red (Start-Stop)	Black-Grey	1
P1C304MK	1	Mushroom Red (Start-Stop)	Black-Grey	1
<b>P1EC400E40</b>	<b>1</b>	<b>Emergency Stop</b>	<b>Yellow-Black</b>	<b>1</b>
<b>P1EC400E40K</b>	<b>1</b>	<b>Emergency Stop, With Plate</b>	<b>Yellow-Black</b>	<b>1</b>
<b>P1EC400E40L</b>	<b>1</b>	<b>Emergency Stop, With Label LED</b>	<b>Yellow-Black</b>	<b>1</b>
P2AB	2	Green-Red (Start-Stop)	Black-Grey	1
P2ABE30	2	Cylindrical Head (Start-Emergency Stop)	Black-Grey	1
P2CC	2	Green-Red (Start-Stop/Start-Stop)	Black-Grey	1
P2CCM	2	Green-Mushroom-Red (Start-Stop/Start-Stop)	Black-Grey	1
P3EC2A1BE30	3	Emergency Stop	Yellow-Grey	1
P43A1B	4	3 Start / 1 Stop	Black-Grey	1
P43A1BE30	4	3 Start / 1 Emergency Stop (Cyl.Head)	Black-Grey	1
P44C	4	4 Start-Stop	Black-Grey	1
P1BOS	1	Empty Box	Black-Grey	1
P1EBOS	1	Empty Box	Yellow-Black	1
P2BOS	2	Empty Box	Black-Grey	1
P3BOS	3	Empty Box	Black-Grey	1
P4BOS	4	Empty Box	Black-Grey	1
P6BOS	6	Empty Box	Black-Grey	1

## M Series (IP65 with Suitable Buttons, Metal Enclosed)

Code	Button Qty	Features	Box Colour	Box/Pcs
<b>M1C200E40</b>	<b>1</b>	<b>Emergency Stop</b>	<b>Yellow-Grey</b>	<b>1</b>
M1C200EE	1	Emergency Stop With Label	Yellow-Grey	1
M1CBOS	1	Empty Box	Yellow-Grey	1

## PY Series (IP65 with available Push Buttons)

Code	Button Qty	Features	Box Colour	Box/Pcs
PY1BOS	1	Empty Box	Black-Grey	1
PY2BOS	2	Empty Box	Black-Grey	1
PY3BOS	3	Empty Box	Black-Grey	1
PY4BOS	4	Empty Box	Black-Grey	1
PY6BOS	6	Empty Box	Black-Grey	1
PY2AB	2	Start - Stop (Monoblock)	Black-Grey	1
PY43A1B	4	3 Start - Stop (Monoblock)	Black-Grey	1

Note: Use Selection Table for your P, PY and M Boxes Special orders. Your special orders will be delivered as individual components if the quantity is less than 50 pcs.

## PK Series (IP65 with available Push Buttons)

Code	Button Qty	Features	Box Colour	Box/Pcs
PK1*	1		Black-Grey	1
PK1M*	1	With Mushroom Button	Black-Grey	1
<b>PK1SE</b>	<b>1</b>	<b>With Emergency Stop Button</b>	<b>Yellow-Black</b>	<b>1</b>
PK2	2		Black-Grey	1
PK3	3		Black-Grey	1
PK31S	3	With 1 Signal (S220*6)	Black-Grey	1
PK4	4		Black-Grey	1
PK5	5		Black-Grey	6
PK6	6		Black-Grey	6
PK1BOS	1	Empty Box	Black-Grey	24
PK2BOS	2	Empty Box	Black-Grey	18
PK3BOS	3	Empty Box	Black-Grey	12
PK4BOS	4	Empty Box	Black-Grey	12
PK5BOS	5	Empty Box	Black-Grey	6
PK6BOS	6	Empty Box	Black-Grey	6

Note: On PK Series control boxes, only KB Series buttons can be mounted.



## Control Boxes Selection Table

Series	1. Hole	2. Hole	3. Hole	4. Hole	5. Hole	6. Hole	Label
<b>PY3</b>	<b>56B</b>	<b>07C</b>	<b>50H</b>	-	-	-	<b>A</b>

### Series

- P1C** Single Hole Plastic Control Box Black-Grey
- P1EC** Single Hole Plastic Control Box Yellow-Black
- PY1** Single Hole Plastic High Control Box Black-Grey
- M1C** Single Hole Aluminium High Control Box Yellow-Grey
- P2** Two Holes Plastic Control Box Black-Grey
- PY2** Two Holes Plastic High Control Box Black-Grey
- P3** Three Holes Plastic Control Box Black-Grey
- P3EC** Three Holes Plastic Control Box Yellow-Black
- PY3** Three Holes Plastic High Control Box Black-Grey
- P4** Four Holes Plastic Control Box Black-Grey
- PY4** Four Holes Plastic High Control Box Black-Grey
- P6** Six Holes Plastic Control Box Black-Grey
- PY6** Six Holes Plastic High Control Box Black-Grey

YOU CAN CREATE YOUR SPECIAL BOX ORDER CODE FROM P BOX CODE COMBINATION TABLE NEXT PAGE

### Label

- Without Label**
- A** BET08
- B** BET18
- C** BET08-Start
- D** BET08-Stop
- E** BET08-01
- F** BET08-01 OK
- G** BET08-201
- H** BET08-201 OK
- I** BET08-201 OK 2
- K** BET60P For closed boxes with single hole
- L** BET60A
- M** Special Label

**Example:** PY3-56B07C502H-A Code means :Box type is PY3 series, 1st Hole is push button where is 56. line and B column in the next page, 2nd Hole is push button where is 7. line and C column in the next page, 3rd Hole push button where is 50. line and Hcolumn in the next page, Label A means BET08.

*Note: Use Selection Table for your P, PY and M Boxes Special orders. Your special orders will be delivered as individual components if the quantity is less than 50 pcs.*

## P Type Box Code Combination Table

	B BUTTON SERIES				C BUTTON SERIES				MB BUTTON SERIES				
	A	B	C	D	E	F	G	H	I	J	K	L	M
01	B100DB	B100S20	B100E	B030XB	CM100DB	CM100S20	CM100E	CM050XB	MB100DB	MB100S20	MB100E	MBSD024B	6PR-PREU1MAVI
02	B100DB-1	B100S21	B100E30	B030XK	CM100DB-00	CM100S21	CM200E	CM060XK	MB100DB-0D	MB100S21	MB102E	MBSD024K	6PR-PREU1MAVIY
03	B100DB-2	B100S30	B100MH	B030XM	CM100DB-0Y	CM101S30	CM200EG	CM070XM	MB100DH	MB101S30	MB102MK	MBSD024M	6PR-PREU1HSIYAH
04	B100DB-L	B100SL20B	B100MK	B030XS	CM100DH	CM101S31	CM200MK	CM080XS	MB100DK	MB101S31	MB200E	MBSD024S	6PR-PRUS1HSIYAH
05	B100DB-0D	B100SL20H	B100MS	B030XY	CM100DH-00	CM101S32	CM200MY	CM090XY	MB100DM	MB101S32	MB200MK	MBSD024Y	
06	B100DB-0Y	B100SL20K	B100MS-Z	B050XB	CM100DK	CM102S30	CP100E	CM080XB	MB100DS	MB102S20	MB200EE	MBSD220B	
07	B100DB-Z	B100SL20M	B100MY	B050XY	CM100DM	CM303S30	CP100M72H	CM0K0XK	MB100DY			MBSD220K	
08	B100DH	B100SL20S	B102E	B060XK	CM100DS	CP100S20	CP100MK	CM0M0XM	MB100FY			MBSD220M	
09	B100DH-0D	B100SL20Y	B102E30	B070XM	CM100DY	CP100S21	CP100MY	CM0S0XS	MB100MY			MBSD220S	
10	B100DH-0Y	B100SL21B	B102E60	B080XS	CM101DH	CP100S30	CP101ES30	CM0Y0XY	MB101DH			MBSD220Y	
11	B100DK	B100SL21K	B102MH	B090XY	CM101DK	CP100S31	CP200E	CM101DJ20	MB101DK			MBSP024B	
12	B100DM	B100SL21Y	B102MK	B0B0XB	CM101DM	CP100S32	CP200E30	CM101DJ21	MB101DM			MBSP024K	
13	B100DS	B100SL30K	B102MY	B0K0XK	CM101DS	CP101S20	CP200EA30	CP050XB	MB101DY			MBSP024M	
14	B100DS-Z	B101S20	B200E	B0M0XM	CM101DY	CP100ECN	CP101S21	CP060XK	MB102DB			MBSP024S	
15	B100DY	B101S21	B200E30	B0S0XS	CM101K20YY-OK	CP101S30	CP200ECN30	CP070XM	MB102DB-0D			MBSP024Y	
16	B100DY-1	B101S30	B200E60	B0Y0XY	CM102DB	CP101S31	CP200EC30	CP080XS	MB102DH			MBSP220B	
17	B100DY-2	B101S31	B200EE	B100AA20	CM102DK	CP101S32	CP200EP	CP090XY	MB102DK			MBSP220K	
18	B100DY-0D	B101S32	B200MH	B100AA21	CM102DM	CP102S30	CP200ES30	CP0B0XB	MB102DM			MBSP220M	
19	B100DY-0Y	B101SL20B	B200MK	B100AC20	CM102DS	CP303S30	CP200MK	CP0K0XK	MB102DS			MBSP220S	
20	B100HB	B101SL20H	B200MS	B100AC30	CM102DY	CP304S20	CP200MY	CP0M0XM	MB102DY			MBSP220Y	
21	B100HH	B101SL20K	B200MY	B100C	CM102K20HB	CP305S30	CP202E	CP0S0XS	MB200DB			MBZS024S	
22	B100HK	B101SL20M	B202EE	B100FB	CM102K20HB-10	CP100HB	CP220E	CP0Y0XY	MB200DH			MBZS220S	
23	B100HM	B101SL20S		B100FH	CM102K20HH	CP100HH	CP200EE	CP101DJ20	MB200DK			MBZ024S	
24	B100HS	B101SL20Y		B100FK	CM102K20KY	CP100HK		CP101DJ21	MB200DM			MBZ220S	
25	B100HY	B101SL30B		B100FM	CM102K21HB	CP100HM		CM101A31	MB200DS				
26	B101DB-0D	B101SL30K		B100FS	CM102K21KY	CP100HS		CM100A20	MB200DY				
27	B101DH	B101SL30M		B100FY	CM200DH-0	CP100HY		CM100A21	MB200FK				
28	B101DM	B101SL30S		B101AA30	CM200DK	CP101HY		CM100A30	MB202DK				
29	B101DY	B101SL30Y		B101AA32	CM200DY	CP102HB		CM101A20					
30	B101DY-0D	B101SL31K		B101AC30	CM202DK	CP102HH		CM101A21					
31	B101HY	B101SL31Y		B101K20BB-12	CM305DY	CP102HK		CM101A30					
32	B102DB	B101SL32B		B101K20HB	CP100DB	CP102HM		CP200AC20					
33	B102DB-0D	B101SL32K		B101K20HH	CP100DB-0D	CP102HS		CP102AA20					
34	B102DH	B101SL32S		B101K20HH-OK	CP100DB-0Y	CP102HY		CP102AA30					
35	B102DK	B101SL32Y		B101K20SS-12	CP100DH	CP200HK		CP102AC30					
36	B102DM	B101T20		B101K20YY-12	CP100DH-0D	CP200HY		CP101AA20					
37	B102DS	B101T20-1		B101K20YY-OK	CP100DH-0Y	CP202HK		CP101AA30					
38	B102DY	B102S20		B102AA20	CP100DK	CP230HK		CP101AC20					
39	B102HB	B102S30		B102AA30	CP100DM			CP101AC30					
40	B102HH	B102S32		B102AC20	CP100DS			CP100AA20					
41	B102HK	B102SL20K		B102AC30	CP100DY			CP100AC20					
42	B102HM	B102SL20Y		B102C	CP101DK			CP100AC30					
43	B102HS	B102SL32Y		B102K20HB	CP101DY			CM102A20					
44	B102HY	B102T20		B102K20KY	CP101K20HB			CM102A21					
45	B130DB	B111S20		B102K20KY-10	CP102DB			CM102A30					
46	B130DH	B121R30		B102K20SH	CP102DH			CM102A31					
47	B130DK	B121R30-1		B102K20SH-10	CP102DK			CM100HB					
48	B130DM	B130SL20B		B102K20SYH-10	CP102DM			CM100HH					
49	B130DS	B130SL20K		B102K21HB	CP102DS			CM100HK					
50	B130DY	B130SL20M		B102K21KY	CP102DY			CM100HM					
51	B130HY	B130SL20S		B132K20HB	CP102K20HB			CM100HS					
52	B131DY	B130SL20Y		B132K20KY	CP102K20HS			CM100HY					
53	B132DK	B130SL21B		B132K21HB	CP102K20KY			CM101HY					
54	B132DS	B130SL21K		B132K21KY	CP102K21HB			CM102HB					
55	B132DY	B130SL21Y		B151K20HH-OK	CP102K21KY			CM102HH					
56	B170DM	B131SL20K		B191K20HB-S	CP200DB			CM102HK					
57	B180DS	B131SL20S		B192K21HB	CP200DK			CM102HM					
58	B190DY	B131SL20Y		B200C	CP200DM			CM102HS					
59	B200DH	B131SL30B		B102K20HSLZ	CP200DS			CM102HY					
60	B200DH-0	B131SL30K			CP200DY			CM200HK					
61	B200DK	B131SL30M			CP202DK			CM200HY					
62	B200DK-0	B131SL30S			CP303DY			CM202HK					
63	B200DM	B131SL30Y			CP305DY			CM230HK					
64	B200DS-L	B131SL31B			CP101K20YYOK								
65	B200DS-Z	B131SL31K											
66	B200DY	B131SL31Y											
67	B200FK	B131SL32B											
68	B200HK	B131SL32K											
69	B200HY	B131SL32Y											
70	B202DK	B132SL30B											
71	B202HK	B132SL30K											
72	B230DK	B132SL30M											
73	B230DY	B132SL30S											
74	B230HK	B132SL30Y											
75	B232DK	B132SL32K											
76	B232DY	B132SL32Y											
77	B100DHL	B160SL20K											
78		B161SL30K											
79		B180SL20S											
80		B190SL20Y											
81		B191SL30Y											
82		B191SL32Y											
83		B1K1SL30K											
84		B1S1SL30S											
85		B1Y1SL30Y											
86		B1Y1SL32Y											



PDKA22GG10G



PDKS11GX23

# Foot Switches



PDP1



PDM11



PDA2



PPKS11BX10



PDKS11BX10



PDKS11GX42G



PDNS11BX10



PDKS11BX10T



PDKS11GX23G



PDKA22GG10G



PDKA22GG10

## Plastic Series

Code	Type	Contact Block	Colour	Box/Pcs
PDM1	Mini	1 CO	●	10
PDM11	Mini, Cable (1m.)	1 CO	●	1
PDP1	Midi	1 NO	●	1
PDP2	Midi	2 NO	●	1

## Aluminium Series

Code	Type	Contact Block	Colour	Box/Pcs
PDA1	Midi	1 NO	●	1
PDA2	Midi	2 NO	●	1

## Foot Protection Series

### Single Foot Switch

Code	Material	Metal Bar Mountable	Contact Block	Speed	With Protection	Box/Pcs
PDNS11BX10	Plastic		1 NO + 1 NC			1
PPKS11BX10	Plastic		1 NO + 1 NC		√	1
PDKS11BX10*	Aluminium		1 NO + 1 NC		√	1
PDKS11BX11*	Aluminium		1 NO + 1 NC	Stay Put	√	1
PDKS11GX10*	Aluminium		2x(1 NO + 1 NC)		√	1
PDKS11GX20*	Aluminium		2x(1 NO + 1 NC)	Double	√	1
PDKS11UX20*	Aluminium		(1 NO + 1 NC) + 2x(1 NO + 1 NC)	Double	√	1
PDKS11VX20*	Aluminium		2x(1 NO + 1 NC) + (1 NO + 1 NC)	Double	√	1
PDKA11BX10*	Aluminium	√	1 NO + 1 NC		√	1
PDKA11GX10*	Aluminium	√	2x(1 NO + 1 NC)		√	1
PDKA11GX20*	Aluminium	√	2x(1 NO + 1 NC)	Double	√	1
PDKS11GX23	Aluminium		(1 NO + 1 NC) + 2 NC	With Reset and Double	√	1

\* Please replace (\*) with the letter T for orange, G for grey.  
Note: BX11 is Stay-Put Type.

## Potentiometer

Code	Material	Metal Bar Mountable	Contact Block	Features	With Protection	Box/Pcs
PDKS11PX10	Aluminium		1 CO	10 k Ω	√	1

## Double Foot Switch

Code	Material	Metal Bar Mountable	Contact Block	Speed	With Protection	Box/Pcs
PDKA22BB10	Aluminium	√	(1NO+1NC) + (1NO+1NC)		√	1
PDKA22BG10	Aluminium	√	(1NO+1NC) + 2x (1 NO+1NC)		√	1
PDKA22BG20	Aluminium	√	(1NO+1NC) + 2x (1NO+1NC)	Double	√	1
PDKA22GG10	Aluminium	√	2x (1NO+1NC) + 2x (1NO+1NC)		√	1
PDKA22GG20	Aluminium	√	2x (1NO+1NC) + 2x (1NO+1NC)	Double	√	1
PDKA22GG10G	Aluminium	√	(1NO + 1NC) + 2x (1NO+1NC)		√	1

## Accessories

Code	Type	With Emergency	Box/Pcs
PDABE	Metal Bar	√	1
PDABT	Metal Bar		1



PDKA22BB10



PDKA11GX10

PDABE





L5K13SOM103



L53K13MIM211



L51K13MIP211



L52K13MIP211



L53K13MIP211



L54K16MIP211



L54K16MIM211

# Limit Switches



L1K13MEM121



L1K13MIM111



L1K13MEL121



L1K13PUM211

## L1 Series, Aluminium Body, Snap Action, IP 65 (except MIP11, MIM11)

Code	Actuator	Actuator Type	Actuator End Unit Material
L1K13MIP111*	Angular Action Roller One Way	Metal	Plastic
L1K13MIM111*	Angular Action Roller One Way	Metal	Metal
L1K13MIP211*	Angular Action Roller One Way	Aluminium	Plastic
L1K13MIM211*	Angular Action Roller One Way	Aluminium	Metal
L1K13MIP311*	Angular Action Roller One Way	Plastic	Plastic
L1K13MIM311*	Angular Action Roller One Way	Plastic	Metal
L1K13MEP121*	Angular Action Roller Two Way	Plastic	Plastic
L1K13MEM121*	Angular Action Roller Two Way	Plastic	Metal
L1K13MEL121*	Angular Action Roller Two Way	Plastic	Rubber
L1K13PUM211*	Plunger	Plastic	Metal
L1K13MUM331*	Linear Roller	Plastic	Metal
L1K13SOM101	Spiral Lever	Plastic	Metal
L1K13SOM102	Spiral Arm	Plastic	Metal
L1K13ROP101*	Rigid Rod	Plastic	Plastic
L1K13SOP101	Spiral Arm	Plastic	Plastic-Metal
L1K13SOP102	Spiral Arm	Plastic	Plastic-Metal
L1K13SOP103	Spiral Arm	Plastic	Plastic-Metal

## L2 Series, Aluminium Body, Plastic Cover, Snap Action, IP 65

Code	Actuator	Actuator Type	Actuator End Unit Material
L2K13MIP211*	Angular Action Roller One Way	Metal	Plastic
L2K13MIM211*	Angular Action Roller One Way	Metal	Metal
L2K13MIP311*	Angular Action Roller One Way	Plastic	Plastic
L2K13MIM311*	Angular Action Roller One Way	Plastic	Metal
L2K13MEP121*	Angular Action Roller Two Way	Plastic	Plastic
L2K13MEP122	Angular Action Roller Two Way, Adjustable	Plastic	Plastic
L2K13MEP123*	Angular Action Roller Two Way, Adjustable	Plastic	Plastic
L2K13MEP124*	Angular Action Roller Two Way, Adjustable	Plastic	Plastic
L2K13MEL121*	Angular Action Roller Two Way, Adjustable	Plastic	Rubber
L2K13MEM121*	Angular Action Roller Two Way	Plastic	Metal
L2K13MEM122	Angular Action Roller Two Way, Adjustable	Plastic	Metal
L2K13MEM123*	Angular Action Roller Two Way, Adjustable	Plastic	Metal
L2K13MEM124*	Angular Action Roller Two Way	Plastic	Metal
L2K13PUM211*	Plunger	Plastic	Metal
L2K13MUM331*	Linear Roller	Plastic	Metal
L2K13SOM101	Spiral Lever	Plastic	Metal
L2K13SOM102	Spiral Arm	Plastic	Metal
L2K13ROP101*	Rigid Rod	Plastic	Plastic
L2K13SOP101	Spiral Arm	Plastic	Plastic-Metal
L2K13SOP102	Spiral Arm	Plastic	Plastic-Metal
L2K13SOP103	Spiral Arm	Plastic	Plastic-Metal

\* Positive opening Function

Note : For different contact block alternatives, please see contact blocks table on [Page 35](#)



L3K13MIM411



L3K13MEP124



L3K13MUM331



L3K13REF121



L3K13MIP311



L3K13MEM121

## L3 Series, Plastic Body, Snap Action, IP 65

Code	Actuator	Actuator Type	Actuator End Unit Material
L3K13MIP311*	Angular Action Roller One Way	Plastic	Plastic
L3K13MIP411*	Angular Action Roller One Way	Plastic	Plastic
L3K13MIM311*	Angular Action Roller One Way	Plastic	Metal
L3K13MIM411*	Angular Action Roller One Way	Plastic	Metal
L3K13MEP121*	Angular Action Roller Two Way	Plastic	Plastic
L3K13MEP122	Angular Action Roller Two Way, Adjustable	Plastic	Plastic
L3K13MEP123*	Angular Action Roller Two Way, Adjustable	Plastic	Plastic
L3K13MEP124*	Angular Action Roller Two Way, Adjustable	Plastic	Plastic
L3K13MEM121*	Angular Action Roller Two Way, Adjustable	Plastic	Metal
L3K13MEM122	Angular Action Roller Two Way, Adjustable	Plastic	Metal
L3K13MEM123*	Angular Action Roller Two Way, Adjustable	Plastic	Metal
L3K13MEM124*	Angular Action Roller Two Way, Adjustable	Plastic	Metal
L3K13MEL121*	Angular Action Roller Two Way, Adjustable	Plastic	Rubber
L3K13MEL122	Angular Action Roller Two Way, Adjustable	Plastic	Rubber
L3K13PUM211*	Plunger	Plastic	Metal
L3K13MUM331*	Linear Roller	Plastic	Metal
L3K13SOM101	Spiral Lever	Plastic	Metal
L3K13SOM102	Spiral Arm	Plastic	Metal
L3K13ROP101*	Rigid Rod	Plastic	Plastic
L3K13SOP101	Spiral Arm	Plastic	Plastic-Metal
L3K13SOP102	Spiral Arm	Plastic	Plastic-Metal
L3K13SOP103	Spiral Arm	Plastic	Plastic-Metal
L3K13REM121*	Metal Arm	Plastic	Metal
L3K13REF121	Fiber Arm	Plastic	Fiber

\* Positive opening Function

Note : For different contact block alternatives, please see contact blocks table on [Page 35](#)



L4K16MIM311



L4K16MEP121

## L4 Series, Aluminium Body, Double Contact Block, Snap Action, IP 65

(Except MIP111, MIM111)

Code	Actuator	Actuator Type	Actuator End Unit Material
L4K16MIM111	Angular Action Roller One Way	Metal	Metal
L4K16MIP111	Angular Action Roller One Way	Metal	Plastic
L4K16MIP211	Angular Action Roller One Way	Metal	Plastic
L4K16MIM211	Angular Action Roller One Way	Metal	Metal
L4K16MIP311	Angular Action Roller One Way	Plastic	Plastic
L4K16MIM311	Angular Action Roller One Way	Plastic	Metal
L4K16MEP121	Angular Action Roller Two Way	Plastic	Plastic
L4K16MEM121	Angular Action Roller Two Way	Plastic	Metal
L4K16PUM211	Plunger	Plastic	Metal
L4K16MUM331	Linear Roller	Plastic	Metal



L5K13MIP311



L5K13MIP411



L5K13MEP123



L5K13MEP124



L5K13MUM331



L5K13MUM332R



L5K13MIP211



L5K13MEL121

## L5 Series, Plastic Body, Snap Action, IP 65

Code	Actuator	Actuator Type	Actuator End Unit Material
L5K13MIP211*	Angular Action Roller One Way (22mm)	Plastic	Plastic
L5K13MIP311*	Angular Action Roller One Way	Plastic	Plastic
L5K13MIM311R	Angular Action Roller One Way, Adjustable	Plastic	Metal
L5K13MIP411*	Angular Action Roller One Way	Plastic	Plastic
L5K13MIP411R*	Angular Action Roller One Way, with Reset	Plastic	Plastic
L5K13MIM211*	Angular Action Roller One Way (22mm)	Plastic	Metal
L5K13MIM311*	Angular Action Roller One Way	Plastic	Metal
L5K13MIM411*	Angular Action Roller One Way	Plastic	Metal
L5K13MIM411R	Angular Action Roller One Way, Adjustable	Plastic	Metal
L5K13MEP121*	Angular Action Roller Two Way	Plastic	Plastic
L5K13MEP122*	Angular Action Roller Two Way, Adjustable	Plastic	Plastic
L5K13MEP123*	Angular Action Roller Two Way, Adjustable	Plastic	Plastic
L5K13MEP124*	Angular Action Roller Two Way, Adjustable	Plastic	Plastic
L5K13MEM121*	Angular Action Roller Two Way	Plastic	Metal
L5K13MEM122*	Angular Action Roller Two Way, Adjustable	Plastic	Metal
L5K13MEM123*	Angular Action Roller Two Way, Adjustable	Plastic	Metal
L5K13MEL121*	Angular Action Roller Two Way	Plastic	Rubber
L5K13MEL122*	Angular Action Roller Two Way, Adjustable	Plastic	Rubber
L5K13MEL123*	Angular Action Roller Two Way, Adjustable	Plastic	Rubber
L5K13MEL123A*	Angular Action Roller Two Way, Adjustable	Plastic	Rubber
L5K13MEM124*	Angular Action Roller Two Way, Adjustable	Plastic	Metal
L5K13PUM211*	Plunger	Plastic	Metal
L5K13PUM211R*	Plunger, with Reset	Plastic	Metal
L5K13PUP211	Plunger	Plastic	Plastic
L5K13MUM331*	Linear Roller	Plastic	Metal
L5K13MUM331R*	Linear Roller, with Reset	Plastic	Metal
L5K13SOM101	Spiral Lever	Plastic	Metal
L5K13SOM102	Spiral Arm	Plastic	Metal
L5K13SOM103	Spiral Arm	Plastic	Metal
L5K13SOP101	Spiral Arm	Plastic	Plastic-Metal
L5K13SOP102	Spiral Arm	Plastic	Plastic-Metal
L5K13SOP103	Spiral Arm	Plastic	Plastic-Metal
L5K13ROP101*	Rigid Rod	Plastic	Plastic
L5K13CPDE	Emergency Stop	Plastic	Plastic
L5K13REM121	Fiber Arm	Plastic	Metal

## L5 Series, Plastic Body, Slow Action, IP 65

Code	Actuator	Actuator Type	Actuator End Unit Material
L5K23MEL123A	Angular Action Roller Two Way, Adjustable	Plastic	Rubber
L5K23SOM103	Spiral Arm	Plastic	Metal
L5K23LEM411*	Hinge	Plastic	Metal
L5K23LEM412*	Hinge	Plastic	Metal
L5K23LEM511*	Hinge	Plastic	Metal
L5K23LEM621*	Hinge	Plastic	Metal
L5K23LEM622*	Hinge	Plastic	Metal
L5K23BEM621*	Rotational Tube	Plastic	Metal
L5K23LUM321*	Curved Key	Plastic	Metal
L5K23LUM322*	Straight Key	Plastic	Metal
L5K23LUM323	Movable Key	Plastic	Metal
L5K23MUM332R*	Linear Roller, with Reset	Plastic	Metal
L5K23CPDE	Emergency Stop	Plastic	Plastic
L5K23LUM324	Movable Key	Plastic	Metal

\* Positive opening Function

Note : For different contact block alternatives, please see contact blocks table on [Page 35](#)



L5K23LEM411



L5K23BEM621



L5K23CPDE



L5K23LUM323





L51K13MIP211



L51K13MIM311



L51K13MIM411



L51K13MEM121



L51K13MEM122



L51K13SOM101



L51K13SOM102

## L51 Series, Metal Body, Snap Action, IP 65

Code	Actuator	Actuator Type	Actuator End Unit Material
L51K13MIP211	Angular Action Roller One Way	Metal	Plastic
L51K13MIP311*	Angular Action Roller One Way	Metal	Plastic
L51K13MIP411	Angular Action Roller One Way	Metal	Plastic
L51K13MIM211	Angular Action Roller One Way	Metal	Metal
L51K13MIM311*	Angular Action Roller One Way	Metal	Metal
L51K13MIM411*	Angular Action Roller One Way	Metal	Metal
L51K13MEP121*	Angular Action Roller Two Way	Metal	Plastic
L51K13MEP122*	Angular Action Roller Two Way, Adjustable	Metal	Plastic
L51K13MEP123*	Angular Action Roller Two Way, Adjustable	Metal	Plastic
L51K13MEP124*	Angular Action Roller Two Way, Adjustable	Metal	Plastic
L51K13MEP125*	Angular Action Roller Two Way	Metal	Plastic-Metal
L51K13MEM121*	Angular Action Roller Two Way	Metal	Metal
L51K13MEM122*	Angular Action Roller Two Way, Adjustable	Metal	Metal
L51K13MEM123*	Angular Action Roller Two Way, Adjustable	Metal	Metal
L51K13MEL121*	Angular Action Roller Two Way	Metal	Rubber
L51K13MEL122*	Angular Action Roller Two Way, Adjustable	Metal	Rubber
L51K13MEL123*	Angular Action Roller Two Way, Adjustable	Metal	Rubber
L51K13MEL123A*	Angular Action Roller Two Way, Adjustable	Metal	Rubber
L51K13MEM124*	Angular Action Roller Two Way, Adjustable	Metal	Plastic-Metal
L51K13MEM125*	Angular Action Roller Two Way	Metal	Metal
L51K13PUM211*	Plunger	Metal	Plastic-Metal
L51K13MUM331*	Linear Roller	Metal	Plastic-Metal
L51K13SOM101	Spiral Lever	Metal	Plastic-Metal
L51K13SOM102	Spiral Arm	Metal	Plastic-Metal
L51K13SOM103	Spiral Arm	Metal	Metal
L51K13SOP101	Spiral Arm	Metal	Plastic-Metal
L51K13SOP102	Spiral Arm	Metal	Plastic-Metal
L51K13SOP103	Spiral Arm	Metal	Plastic-Metal
L51K13ROP101*	Rigid Rod	Metal	Plastic
L51K13REF121	Rigid Rod	Metal	Fiber
L51K13REM121*	Rigid Rod	Metal	Metal
L51K13LEM411	Hinge	Metal	Metal
L51K13LEM412	Hinge	Metal	Metal
L51K13LEM511	Hinge	Metal	Metal
L51K13LEM621	Hinge	Metal	Metal
L51K13LEM622	Hinge	Metal	Metal



L51K23LUM321

## L51 Series, Metal Body, Slow Action, IP 65

Code	Actuator	Actuator Type	Actuator End Unit Material
L51K23LUM321*	Curved Key	Metal	Metal
L51K23LUM322*	Straight Key	Metal	Metal
L51K23LUM323	Movable Key	Metal	Metal
L51K23LUM324	Movable Key	Metal	Metal
L51K23HUM111	Metal Ring	Metal	Metal
L51K23HUM112	Metal Ring, with Reset	Metal	Metal

\* Positive opening Function

Note : For different contact block alternatives, please see contact blocks table on [Page 35](#)



L52K13MIM311



L52K13MIM411



L52K13MEP123



L52K13MEP124



L52K13MUM331



L52K13PUM211



L52K13REF121



L52K13REM121



L52K13MIP211

## L52 Series, Metal Body, Snap Action, IP 65

Code	Actuator	Actuator Type	Actuator End Unit Material
L52K13MIP211	Angular Action Roller One Way	Metal	Plastic
L52K13MIP311*	Angular Action Roller One Way	Metal	Plastic
L52K13MIP411*	Angular Action Roller One Way	Metal	Plastic
L52K13MIM211	Angular Action Roller One Way	Metal	Metal
L52K13MIM311*	Angular Action Roller One Way	Metal	Metal
L52K13MIM411*	Angular Action Roller One Way	Metal	Metal
L52K13MEP121*	Angular Action Roller Two Way	Metal	Plastic
L52K13MEP122*	Angular Action Roller Two Way, Adjustable.	Metal	Plastic
L52K13MEP123*	Angular Action Roller Two Way, Adjustable.	Metal	Plastic
L52K13MEP124*	Angular Action Roller Two Way, Adjustable.	Metal	Plastic
L52K13MEP125*	Angular Action Roller Two Way	Metal	Plastic-Metal
L52K13MEM121*	Angular Action Roller Two Way	Metal	Metal
L52K13MEM122*	Angular Action Roller Two Way, Adjustable.	Metal	Metal
L52K13MEM123*	Angular Action Roller Two Way, Adjustable.	Metal	Metal
L52K13MEL121*	Angular Action Roller Two Way, Adjustable.	Metal	Rubber
L52K13MEL122*	Angular Action Roller Two Way	Metal	Rubber
L52K13MEL123*	Angular Action Roller Two Way, Adjustable.	Metal	Rubber
L52K13MEL123A*	Angular Action Roller Two Way, Adjustable.	Metal	Rubber
L52K13MEM124*	Angular Action Roller Two Way, Adjustable.	Metal	Metal
L52K13PUM211*	Plunger	Metal	Metal
L52K13MUM331*	Linear Roller	Metal	Metal
L52K13MUP331	Linear Roller	Metal	Plastic
L52K13SOM101	Spiral Lever	Metal	Metal
L52K13SOM102	Spiral Arm	Metal	Metal
L52K13SOM103	Spiral Arm	Metal	Metal
L52K13SOP101	Spiral Arm	Metal	Plastic-Metal
L52K13SOP102	Spiral Arm	Metal	Plastic-Metal
L52K13SOP103	Spiral Arm	Metal	Plastic-Metal
L52K13ROP101*	Rigid Rod	Metal	Plastic
L52K13REF121	Rigid Rod	Metal	Fiber
L52K13REM121*	Rigid Rod	Metal	Metal
L52K13LEM411	Hinge	Metal	Metal
L52K13LEM412	Hinge	Metal	Metal
L52K13LEM511	Hinge	Metal	Metal
L52K13LEM621	Hinge	Metal	Metal
L52K13LEM622	Hinge	Metal	Metal

\* Positive opening Function ⊕

Note : For different contact block alternatives, please see contact blocks table on Page 35



L52K23HUM111



L52K23HUM112

## L52 Series, Metal Body, Slow Action

Code	Actuator	Actuator Type	Actuator End Unit Material
L52K23LUM321*	Curved Key	Metal	Metal
L52K23LUM322*	Straight Key	Metal	Metal
L52K23LUM323	Movable Key	Metal	Metal
L52K23LUM324	Movable Key	Metal	Metal
L52K23HUM111	Metal Ring	Metal	Metal
L52K23HUM112	Metal Ring, with Reset	Metal	Metal

\* Positive opening Function ⊕



L53K13MIP211



L53K13MIM311



L53K13MEP125



L53K13MEL123



L53K13MEL123A



L53K13PUM211



L53K13MUM331



L53K13SOM102



L53K13SOP103

## L53 Series, Metal Body, Heavy Duty with 3 Cable Entry, Snap Action, IP 65

Code	Actuator	Actuator Type	Actuator End Unit Material
L53K13MIP211	Angular Action Roller One Way	Metal	Plastic
L53K13MIP311*	Angular Action Roller One Way	Metal	Plastic
L53K13MIP411*	Angular Action Roller One Way	Metal	Plastic
L53K13MIM211	Angular Action Roller (22 mm)	Metal	Metal
L53K13MIM311*	Angular Action Roller One Way	Metal	Metal
L53K13MEP121*	Angular Action Roller Two Way	Metal	Plastic
L53K13MEP122*	Angular Action Roller Two Way, Adjustable.	Metal	Plastic
L53K13MEP123*	Angular Action Roller Two Way, Adjustable.	Metal	Plastic
L53K13MEP124*	Angular Action Roller Two Way, Adjustable.	Metal	Plastic
L53K13MEP125*	Angular Action Roller Two Way, Adjustable.	Metal	Plastic
L53K13MEM121*	Angular Action Roller Two Way	Metal	Metal
L53K13MEM122*	Angular Action Roller Two Way, Adjustable.	Metal	Metal
L53K13MEM123*	Angular Action Roller Two Way, Adjustable.	Metal	Metal
L53K13MEL121*	Angular Action Roller Two Way.	Metal	Rubber
L53K13MEL122*	Angular Action Roller Two Way, Adjustable.	Metal	Rubber
L53K13MEL123*	Angular Action Roller Two Way, Adjustable.	Metal	Rubber
L53K13MEL123A*	Angular Action Roller Two Way, Adjustable.	Metal	Rubber
L53K13MEM124*	Angular Action Roller Two Way, Adjustable.	Metal	Metal
L53K13MEM125*	Angular Action Roller Two Way	Metal	Metal
L53K13PUM211*	Plunger	Metal	Metal
L53K13MUM331*	Linear Roller	Metal	Metal
L53K13MUP331	Linear Roller	Metal	Plastic
L53K13SOM101	Spiral Lever	Metal	Metal
L53K13SOM102	Spiral Arm	Metal	Metal
L53K13SOM103	Spiral Arm	Metal	Metal
L53K13SOP101	Spiral Arm	Metal	Plastic-Metal
L53K13SOP102	Spiral Arm	Metal	Plastic-Metal
L53K13SOP103	Spiral Arm	Metal	Plastic-Metal
L53K13ROP101*	Rigid Rod	Metal	Plastic
L53K13REF121	Rigid Rod	Metal	Fiber
L53K13REM121	Fiber Arm	Metal	Metal
L53K13LEM411	Hinge	Metal	Metal
L53K13LEM412	Hinge	Metal	Metal
L53K13LEM511	Hinge	Metal	Metal
L53K13LEM621	Hinge	Metal	Metal
L53K13LEM622	Hinge	Metal	Metal

## L53 Series, Metal Body, Heavy Duty With 3 Cable Entry, Slow Action, IP 65

Code	Actuator	Actuator Type	Actuator End Unit Material
L53K23LUM321	Curved Key	Metal	Metal
L53K23LUM322	Straight Key	Metal	Metal
L53K23HUM111	Metal Ring	Metal	Metal
L53K23HUM112	Metal Ring, with Reset	Metal	Metal

\* Positive opening Function

Note : For different contact block alternatives, please see contact blocks table on [Page 35](#)



L54K16MIP211



L54K16MIM211



L54K16MIP311



L54K16MIM311



L54K16MEP121



L54K16MEM121



L54K16MEM122



L54K16MEP124



L54K16MEM123



L54K16MEM124



L54K16PUM211

## L54 Series, Snap and Slow Action, IP65

Code	Actuator	Actuator Type	Actuator End Unit Material
L54K16MIP211	Angular Action Roller One Way	Metal	Plastic
L54K16MIM211	Angular Action Roller One Way	Metal	Metal
L54K16MIP311	Angular Action Roller One Way	Metal	Plastic
L54K16MIM311	Angular Action Roller One Way	Metal	Metal
L54K16MEP121	Angular Action Roller Two Way	Metal	Plastic
L54K16MEM121	Angular Action Roller Two Way	Metal	Metal
L54K16MEP122	Angular Action Roller Two Way, Adjustable	Metal	Plastic
L54K16MEM122	Angular Action Roller Two Way,	Metal	Metal
L54K16MEP123	Angular Action Roller Two Way, Adjustable	Metal	Plastic
L54K16MEM123	Angular Action Roller Two Way, Adjustable	Metal	Metal
L54K16MEP124	Angular Action Roller Two Way, Adjustable	Metal	Plastic
L54K16MEM124	Angular Action Roller Two Way, Adjustable	Metal	Metal
L54K16MEL121	Angular Action Roller Two Way	Metal	Rubber
L54K16MEL122	Angular Action Roller Two Way	Metal	Rubber
L54K16MEL123	Angular Action Roller Two Way, Adjustable	Metal	Rubber
L54K16PUM211	Plunger	Metal	Metal
L54K16MUM331	Linear Roller	Metal	Metal

## L61 Series, Metal Body, With Cable, IP67, Snap Action (2 mt.cable)



L61K13MUM331

Code	Actuator	Actuator Type	Actuator End Unit Material
L61K13MUM331*	Linear Roller	Metal	Metal
L61K13PUM211*	Plunger	Metal	Metal
L61K13MEM121*	Angular Action Roller Two Way	Metal	Metal
L61K13MEP121*	Angular Action Roller Two Way	Metal	Plastic



L66K13MEP121

## L66 Series, Plastic Body, With Cable, IP67, Snap Action (2 mt.cable)

Code	Actuator	Actuator Type	Actuator End Unit Material
L66K13MUM331*	Linear Roller	Metal	Metal
L66K13PUM211*	Plunger	Metal	Metal
L66K13MEM121*	Angular Action Roller Two Way	Plastic	Metal
L66K13MEP121*	Angular Action Roller Two Way	Plastic	Plastic

\* Positive opening Function ↻



## Spare Parts of Limit Switches



LD11MIP111



LD22MIP211



LD23MIP411



LD23MEM121



LD23SOP101



LD23ROP101



LD33MIP311



LD33MUM331



LA33LUM323



LA33LUM324

### Actuator

Code	Body Type	Actuator Type	End Unit Material	Features	Box/Pcs
LD11MIP111	L1,L4	Angular Action Roller One Way	Plastic	Metal Sheet Construction	20
LD11MIM111	L1,L4	Angular Action Roller One Way	Metal	Metal Sheet Construction	20
LD22MIP211	L1,L2,L4	Angular Action Roller One Way	Plastic	Metal Construction	20
LD22MIM211	L1,L2,L4	Angular Action Roller One Way	Metal	Metal Construction	20
LD23MIP311	L1,L2,L3,L4	Angular Action Roller One Way	Plastic	Plastic Construction	20
LD23MIM311	L1,L2,L3,L4	Angular Action Roller One Way	Metal	Plastic Construction	20
LD23MIP411	L3	Angular Action Roller One Way	Plastic	Plastic Construction with Angle	20
LD23MIM411	L3	Angular Action Roller One Way	Metal	Plastic Construction with Angle	20
LD23MEP121	L1,L2,L3,L4	Angular Action Roller Two Way	Plastic	Plastic Construction - Rotating Arm	20
LD23MEM121	L1,L2,L3,L4	Angular Action Roller Two Way	Metal	Plastic Construction - Rotating Arm	20
LD23PUM211	L1,L2,L3,L4	Plunger	Metal	Plastic Construction	20
LD23MUM331	L1,L2,L3,L4	Linear Roller	Metal	Plastic Construction	20
LD23SOM101	L1,L2,L3	Spiral Lever	Metal	Plastic Construction - Multi Way	20
LD23SOM102	L1,L2,L3	Spiral Arm	Metal	Plastic Construction - Multi Way	20
LD23SOP101	L1,L2,L3	Spiral Arm	Plastic	Plastic Construction - Multi Way	20
LD23SOP102	L1,L2,L3	Spiral Arm	Plastic	Plastic Construction - Multi Way	20
LD23SOP103	L1,L2,L3	Spiral Arm	Plastic	Plastic Construction - Multi Way	20
LD23ROP101	L1,L2,L3	Rigid Rod	Plastic	Plastic Construction - Multi Way	20
LD23MEL121	L1,L2,L3	Angular Action Roller Two Way	Rubber	Plastic Construction - Rotating Arm	20
LD23MEP123	L2,L3	Angular Action Roller Two Way	Plastic	Plastic Construction - Rotating Arm	20
LD23MEM123	L2,L3	Angular Action Roller Two Way	Metal	Plastic Construction - Rotating Arm	20
LD33MIM311	L5	Angular Action Roller One Way	Metal	Plastic Construction with Angle	20
LD33MIP311	L5	Angular Action Roller One Way	Plastic	Plastic Construction with Angle	20
LD33MIP411	L5	Angular Action Roller One Way	Plastic	Plastic Construction with Angle	20
LD33MEP121	L5	Angular Action Roller Two Way	Plastic	Plastic Construction - Rotating Arm	20
LD33MEP122	L5	Angular Action Roller Two Way	Plastic	Plastic Construction - Rotating Arm	20
LD33MEP123	L5	Angular Action Roller Two Way	Plastic	Plastic Construction - Rotating Arm	20
LD33MEM122	L5	Angular Action Roller Two Way	Metal	Plastic Construction - Rotating Arm	20
LD33MEL121	L5	Angular Action Roller Two Way	Rubber	Plastic Construction - Rotating Arm	20
LD33MEL122	L5	Angular Action Roller Two Way	Rubber	Plastic Construction - Rotating Arm	20
LD33MEL123	L5	Angular Action Roller Two Way	Rubber	Plastic Construction - Rotating Arm	20
LD33MEL124	L5	Angular Action Roller Two Way	Rubber	Plastic Construction - Rotating Arm	20
LD33MUP331	L5	Linear Roller	Plastic	Plastic Construction	20
LD33MUM331	L5	Linear Roller	Metal	Plastic Construction	20
LD33CPDE	L5	Emergency Stop	Plastic	Plastic Construction	20
LD33CPA	L5	Button Adapter	-	-	20
LA33LUM320	L5,L51,L52,L53	Straight Key	Metal	-	20
LA33LUM321	L5,L51,L52,L53	Curved Key	Metal	-	20
LA33LUM323	L5,L51,L52,L53	Movable Security Key	Plastic	-	20
LA33LUM324	L5,L51,L52,L53	Movable Security Key	Plastic	-	20



LD51SOM102



LD51SOP102



LD51MEP121



LD51MIP311



LD51MUM331



LD51MEM124



LD51MEM123



LD51MEP123



LK20K13



LK20K25



LK20K28



L5K13



L52K13

## Spare Parts - Actuators

Code	Body Type	Actuator	End Unit Material	Features	Box/Pcs
LD33SOM101	L5	Spiral Lever	Metal	Plastic Construction - Multi Way	20
LD33SOP101	L5	Spiral Lever	Plastic	Plastic Construction - Multi Way	20
LD33SOM102	L5	Spiral Arm	Metal	Plastic Construction - Multi Way	20
LD33SOP102	L5	Spiral Arm	Plastic	Plastic Construction - Multi Way	20
LD33LUM321	L5	Hinge	Metal	Metal Construction - Rotating Arm	20
LD33LUM322	L5	Hinge	Metal	Metal Construction - Rotating Arm	20
LD33LEM622	L5	Hinge	Metal	Metal Construction - Rotating Arm	20
LD33BEM621	L5	Rotational Tube	Hinge	Met. Construction-Rotational Tube	20
LD33REF121	L5	Rigid Rod	Fiber	Plastic Construction-Rotating Arm	20
LD51MIM311	L51, L52	Angular Action Roller One Way	Metal	Metal Construction	20
LD51MIP211	L51, L52	Angular Action Roller One Way	Plastic	Metal Construction	20
LD51MIP311	L51, L52	Angular Action Roller Two Way	Plastic	Metal Construction - Rotating Arm	20
LD51MEP121	L51, L52	Angular Action Roller Two Way	Plastic	Metal Construction - Rotating Arm	20
LD51MEM121	L51, L52	Angular Action Roller Two Way	Metal	Metal Construction - Rotating Arm	20
LD51MEP123	L51, L52	Angular Action Roller Two Way	Plastic	Metal Construction - Long Rotating Arm	20
LD51MEM123	L51, L52	Angular Action Roller Two Way	Metal	Metal Construction - Long Rotating Arm	20
LD51MEM124	L51, L52	Angular Action Roller Two Way	Metal	Metal Construction - Long Rotating Arm	20
LD51MEL121	L51, L52	Angular Action Roller Two Way	Rubber	Plastic Construction-Rotating Arm	20
LD51MEL122	L51, L52	Angular Action Roller Two Way	Rubber	Plastic Construction-Rotating Arm	20
LD51MUM331	L51, L52	Plunger with Roll	Metal	Metal Construction	20
LD51SOP101	L51, L52	Spiral Lever	Plastic	Metal Construction - Multi Way	20
LD51SOP102	L51, L52	Spiral Arm	Plastic	Metal Construction - Multi Way	20
LD51SOM102	L51, L52	Spiral Arm	Metal	Metal Construction - Multi Way	20
LD53MIM311	L53, L54	Angular Action Roller One Way	Metal	Metal Construction	20
LD53MIP211	L53, L54	Angular Action Roller One Way	Plastic	Metal Construction	20
LD53MIP311	L53, L54	Angular Action Roller Two Way	Plastic	Metal Construction - Rotating Arm	20
LD53MEP121	L53, L54	Angular Action Roller Two Way	Plastic	Metal Construction - Rotating Arm	20
LD53MEM121	L53, L54	Angular Action Roller Two Way	Metal	Metal Construction - Rotating Arm	20
LD53MEP123	L53, L54	Angular Action Roller Two Way	Plastic	Metal Construction - Long Rotating Arm	20
LD53MEM123	L53, L54	Angular Action Roller Two Way	Metal	Metal Construction - Long Rotating Arm	20
LD53MEM124	L53, L54	Angular Action Roller Two Way	Metal	Metal Construction - Long Rotating Arm	20
LD53MEL121	L53, L54	Angular Action Roller Two Way	Rubber	Plastic Construction - Rotating Arm	20
LD53MEL122	L53, L54	Angular Action Roller Two Way	Rubber	Plastic Construction - Rotating Arm	20
LD53MUM331	L53, L54	Linear Roller	Metal	Metal Construction	20
LD53SOP101	L53, L54	Spiral Arm	Metal	Metal Construction - Multi Way	20
LD53SOP102	L53, L54	Spiral Arm	Plastic	Metal Construction - Multi Way	20
LD53SOM102	L53, L54	Spiral Arm	Metal	Metal Construction - Multi Way	20

## Spare Parts - Contact Blocks

Code	Action Type	Contact Block	Plunger Types	Body Type	Box/Pcs
LK10K13	Snap	1 NC + 1 NO	Short	L4	30
LK10K23	Slow	1 NC + 1 NO	Short	L4	30
LK11K13	Snap	1 NC + 1 NO	Long	L4	30
LK11K23	Slow	1 NC + 1 NO	Long	L4	30
LK20K12	Snap	1NC + 1 NC	Short	L1, L2, L3, L5, L51, L52, L53, L54	30
LK20K13*	Snap	1 NC + 1 NO	Short	L1, L2, L3, L5, L51, L52, L53, L54	30
LK20K23*	Slow	1 NC + 1 NO	Short	L1, L2, L3, L5, L51, L52, L53, L54	30
LK20K25*	Slow	2 NC + 1 NO	Short	L1, L2, L3, L5, L51, L52, L53, L54	30
LK20K27*	Slow	1 NC + 2 NO	Short	L1, L2, L3, L5, L51, L52, L53, L54	30
LK20K28*	Slow	1 NC + 1 NC	Delayed Short	L1-L54-CSM10	10
LK20K29*	Slow	1 NC + 1 NO	Overlapped Short	L1, L2, L3, L5, L51, L52, L53, L54	30

## Body (Housing)

Code	Body Type	Box/Pcs
L1K13	Aluminium	1
L2K13	Aluminium	1
L3K13	Plastic	1
L5K13	Plastic	1
L51K13	Metal	1
L52K13	Metal	1
L53K13	Metal	1
L54K16	Metal	1

\* Positive opening Function



SIM30NM1RSX



SIM12FM1PSX



SIM12NM1RSX



SIQ18FP1NC2



SCM30NP1PSX



SMB31LC2-B15

## S Series Sensors

- Rapid switching capacity
- Easy to install
- Works in heavy industrial conditions
- Short circuit and overload protection
- Reverse polarity protection

# Sensors

**Inductive Proximity Switches (3 Wire), IP67**

SIM12FM1PC2



SIM12NM1RC2



SIM12FM1PSX



SIM18NM1PC2



SIM30NM1RSX



SIM30FM1PC2



SIQ18FP1NC2

Code	Body Type	Voltage	Sensing Distance	Mounting	Switching Frequency	Connection	Output
SIM12FM1NC2	Cylinder 12	10-30 V DC	2mm	Flush	800 Hz	Wire Connection(2m)	NPN-NO
SIM12FM1NSX	Cylinder 12	10-30 V DC	2mm	Flush	800 Hz	M12 Connector	NPN-NO
SIM12FM1OC2	Cylinder 12	10-30 V DC	2mm	Flush	800 Hz	Wire Connection(2m)	NPN-NC
SIM12FM1OSX	Cylinder 12	10-30 V DC	2mm	Flush	800 Hz	M12 Connector	NPN-NC
SIM12FM1PC2	Cylinder 12	10-30 V DC	2mm	Flush	800 Hz	Wire Connection(2m)	PNP-NO
SIM12FM1PSX	Cylinder 12	10-30 V DC	2mm	Flush	800 Hz	M12 Connector	PNP-NO
SIM12FM1RC2	Cylinder 12	10-30 V DC	2mm	Flush	800 Hz	Wire Connection(2m)	PNP-NC
SIM12FM1RSX	Cylinder 12	10-30 V DC	2mm	Flush	800 Hz	M12 Connector	PNP-NC
SIM12NM1NC2	Cylinder 12	10-30 V DC	4mm	Nonflush	400 Hz	Wire Connection(2m)	NPN-NO
SIM12NM1NSX	Cylinder 12	10-30 V DC	4mm	Nonflush	400 Hz	M12 Connector	NPN-NO
SIM12NM1OC2	Cylinder 12	10-30 V DC	4mm	Nonflush	400 Hz	Wire Connection(2m)	NPN-NC
SIM12NM1OSX	Cylinder 12	10-30 V DC	4mm	Nonflush	400 Hz	M12 Connector	NPN-NC
SIM12NM1PC2	Cylinder 12	10-30 V DC	4mm	Nonflush	400 Hz	Wire Connection(2m)	PNP-NO
SIM12NM1PSX	Cylinder 12	10-30 V DC	4mm	Nonflush	400 Hz	M12 Connector	PNP-NO
SIM12NM1RC2	Cylinder 12	10-30 V DC	4mm	Nonflush	400 Hz	Wire Connection(2m)	PNP-NC
SIM12NM1RSX	Cylinder 12	10-30 V DC	4mm	Nonflush	400 Hz	M12 Connector	PNP-NC
SIM18FM1NC2	Cylinder 18	10-30 V DC	5mm	Flush	800 Hz	Wire Connection(2m)	NPN-NO
SIM18FM1OC2	Cylinder 18	10-30 V DC	5mm	Flush	800 Hz	Wire Connection(2m)	NPN-NC
SIM18FM1PC2	Cylinder 18	10-30 V DC	5mm	Flush	800 Hz	Wire Connection(2m)	PNP-NO
SIM18FM1RC2	Cylinder 18	10-30 V DC	5mm	Flush	800 Hz	Wire Connection(2m)	PNP-NC
SIM18NM1NC2	Cylinder 18	10-30 V DC	8mm	Nonflush	400 Hz	Wire Connection(2m)	NPN-NO
SIM18NM1OC2	Cylinder 18	10-30 V DC	8mm	Nonflush	400 Hz	Wire Connection(2m)	NPN-NC
SIM18NM1PC2	Cylinder 18	10-30 V DC	8mm	Nonflush	400 Hz	Wire Connection(2m)	PNP-NO
SIM18NM1RC2	Cylinder 18	10-30 V DC	8mm	Nonflush	400 Hz	Wire Connection(2m)	PNP-NC
SIM30FM1NC2	Cylinder 30	10-30 V DC	10mm	Flush	400 Hz	Wire Connection(2m)	NPN-NO
SIM30FM1NSX	Cylinder 30	10-30 V DC	10mm	Flush	400 Hz	M12 Connector	NPN-NO
SIM30FM1OC2	Cylinder 30	10-30 V DC	10mm	Flush	400 Hz	Wire Connection(2m)	NPN-NC
SIM30FM1OSX	Cylinder 30	10-30 V DC	10mm	Flush	400 Hz	M12 Connector	NPN-NC
SIM30FM1PC2	Cylinder 30	10-30 V DC	10mm	Flush	400 Hz	Wire Connection(2m)	PNP-NO
SIM30FM1PSX	Cylinder 30	10-30 V DC	10mm	Flush	400 Hz	M12 Connector	PNP-NO
SIM30FM1RC2	Cylinder 30	10-30 V DC	10mm	Flush	400 Hz	Wire Connection(2m)	PNP-NC
SIM30FM1RSX	Cylinder 30	10-30 V DC	10mm	Flush	400 Hz	M12 Connector	PNP-NC
SIM30NM1NC2	Cylinder 30	10-30 V DC	15mm	Nonflush	200 Hz	Wire Connection(2m)	NPN-NO
SIM30NM1NSX	Cylinder 30	10-30 V DC	15mm	Nonflush	200 Hz	M12 Connector	NPN-NO
SIM30NM1OC2	Cylinder 30	10-30 V DC	15mm	Nonflush	200 Hz	Wire Connection(2m)	NPN-NC
SIM30NM1OSX	Cylinder 30	10-30 V DC	15mm	Nonflush	200 Hz	M12 Connector	NPN-NC
SIM30NM1PC2	Cylinder 30	10-30 V DC	15mm	Nonflush	200 Hz	Wire Connection(2m)	PNP-NO
SIM30NM1PSX	Cylinder 30	10-30 V DC	15mm	Nonflush	200 Hz	M12 Connector	PNP-NO
SIM30NM1RC2	Cylinder 30	10-30 V DC	15mm	Nonflush	200 Hz	Wire Connection(2m)	PNP-NC
SIM30NM1RSX	Cylinder 30	10-30 V DC	15mm	Nonflush	200 Hz	M12 Connector	PNP-NC
SIQ18FP1NC2	Square 18	10-30V DC	5mm	Flush	800 Hz	Wire Connection(2m)	NPN-NO
SIQ18FP1NC7	Square 18	10-30V DC	5mm	Flush	800 Hz	Wire Connection (7m)	NPN-NO
SIQ18FP1OC2	Square 18	10-30V DC	5mm	Flush	800 Hz	Wire Connection(2m)	NPN-NC
SIQ18FP1OC7	Square 18	10-30V DC	5mm	Flush	800 Hz	Wire Connection (7m)	NPN-NC
SIQ18FP1PC2	Square 18	10-30V DC	5mm	Flush	800 Hz	Wire Connection(2m)	PNP-NO
SIQ18FP1PC7	Square 18	10-30V DC	5mm	Flush	800 Hz	Wire Connection (7m)	PNP-NO
SIQ18FP1RC2	Square 18	10-30V DC	5mm	Flush	800 Hz	Wire Connection(2m)	PNP-NC
SIQ18FP1RC7	Square 18	10-30V DC	5mm	Flush	800 Hz	Wire Connection (7m)	PNP-NC
SIQ18NP1NC2	Square 18	10-30V DC	8mm	Nonflush	400 Hz	Wire Connection(2m)	NPN-NO
SIQ18NP1NC7	Square 18	10-30V DC	8mm	Nonflush	400 Hz	Wire Connection (7m)	NPN-NO
SIQ18NP1OC2	Square 18	10-30V DC	8mm	Nonflush	400 Hz	Wire Connection(2m)	NPN-NC
SIQ18NP1OC7	Square 18	10-30V DC	8mm	Nonflush	400 Hz	Wire Connection (7m)	NPN-NC
SIQ18NP1PC2	Square 18	10-30V DC	8mm	Nonflush	400 Hz	Wire Connection(2m)	PNP-NO
SIQ18NP1PC7	Square 18	10-30V DC	8mm	Nonflush	400 Hz	Wire Connection (7m)	PNP-NO
SIQ18NP1RC2	Square 18	10-30V DC	8mm	Nonflush	400 Hz	Wire Connection(2m)	PNP-NC
SIQ18NP1RC7	Square 18	10-30V DC	8mm	Nonflush	400 Hz	Wire Connection (7m)	PNP-NC





SCM18NP1NC2



SCM30NP1PC2

**Capacitive Proximity Switches (3 Wire), IP65**

Code	Body Type	Voltage	Sensing Distance	Mounting	Body Material	Connection	Output
SCM18NP1NC2	Cylinder 18	10-30 V DC	2-10mm	Nonflush	Plastic	Wire Connection(2m)	NPN-NO
SCM18NP1OC2	Cylinder 18	10-30 V DC	2-10mm	Nonflush	Plastic	Wire Connection(2m)	NPN-NC
SCM18NP1PC2	Cylinder 18	10-30 V DC	2-10mm	Nonflush	Plastic	Wire Connection(2m)	PNP-NO
SCM18NP1RC2	Cylinder 18	10-30 V DC	2-10mm	Nonflush	Plastic	Wire Connection(2m)	PNP-NC
SCM30NM1NC2	Cylinder 30	10-30 V DC	3-15mm	Nonflush	Metal	Wire Connection(2m)	NPN-NO
SCM30NM1NSX	Cylinder 30	10-30 V DC	3-15mm	Nonflush	Metal	M12 Connector	NPN-NO
SCM30NM1OC2	Cylinder 30	10-30 V DC	3-15mm	Nonflush	Metal	Wire Connection(2m)	NPN-NC
SCM30NM1OSX	Cylinder 30	10-30 V DC	3-15mm	Nonflush	Metal	M12 Connector	NPN-NC
SCM30NM1PC2	Cylinder 30	10-30 V DC	3-15mm	Nonflush	Metal	Wire Connection(2m)	PNP-NO
SCM30NM1PSX	Cylinder 30	10-30 V DC	3-15mm	Nonflush	Metal	M12 Connector	PNP-NO
SCM30NM1RC2	Cylinder 30	10-30 V DC	3-15mm	Nonflush	Metal	Wire Connection(2m)	PNP-NC
SCM30NM1RSX	Cylinder 30	10-30 V DC	3-15mm	Nonflush	Metal	M12 Connector	PNP-NC
SCM30NP1NC2	Cylinder 30	10-30 V DC	3-15mm	Nonflush	Plastic	Wire Connection(2m)	NPN-NO
SCM30NP1NSX	Cylinder 30	10-30 V DC	3-15mm	Nonflush	Plastic	M12 Connector	NPN-NO
SCM30NP1OC2	Cylinder 30	10-30 V DC	3-15mm	Nonflush	Plastic	Wire Connection(2m)	NPN-NC
SCM30NP1OSX	Cylinder 30	10-30 V DC	3-15mm	Nonflush	Plastic	M12 Connector	NPN-NC
SCM30NP1PC2	Cylinder 30	10-30 V DC	3-15mm	Nonflush	Plastic	Wire Connection(2m)	PNP-NO
SCM30NP1PSX	Cylinder 30	10-30 V DC	3-15mm	Nonflush	Plastic	M12 Connector	PNP-NO
SCM30NP1RC2	Cylinder 30	10-30 V DC	3-15mm	Nonflush	Plastic	Wire Connection(2m)	PNP-NC
SCM30NP1RSX	Cylinder 30	10-30 V DC	3-15mm	Nonflush	Plastic	M12 Connector	PNP-NC



SCB22MP1NC1

**Capacitive Button, IP67**

Code	Body Type	Voltage	Sensing Distance	Mounting Type	Body Material	Connection	Output
SCB22MP1NC1	Dia 22 mm	10-30 V DC	Touch	Button	Plastic	1 Metre Cable	NPN-NO
SCB22MP1NSX	Dia 22 mm	10-30 V DC	Touch	Button	Plastic	M12 Connector	NPN-NO
SCB22MP1OC1	Dia 22 mm	10-30 V DC	Touch	Button	Plastic	1 Metre Cable	NPN-NC
SCB22MP1OSX	Dia 22 mm	10-30 V DC	Touch	Button	Plastic	M12 Connector	NPN-NC
SCB22MP1PC1	Dia 22 mm	10-30 V DC	Touch	Button	Plastic	1 Metre Cable	PNP-NO
SCB22MP1PSX	Dia 22 mm	10-30 V DC	Touch	Button	Plastic	M12 Connector	PNP-NO
SCB22MP1RC1	Dia 22 mm	10-30 V DC	Touch	Button	Plastic	1 Metre Cable	PNP-NC
SCB22MP1RSX	Dia 22 mm	10-30 V DC	Touch	Button	Plastic	M12 Connector	PNP-NC
SCB22MP5NC1	Dia 22 mm	10-30 V DC, Stay Put	Touch	Button	Plastic	1 Metre Cable	NPN-NO
SCB22MP5NSX	Dia 22 mm	10-30 V DC, Stay Put	Touch	Button	Plastic	M12 Connector	NPN-NO
SCB22MP5OC1	Dia 22 mm	10-30 V DC, Stay Put	Touch	Button	Plastic	1 Metre Cable	NPN-NC
SCB22MP5OSX	Dia 22 mm	10-30 V DC, Stay Put	Touch	Button	Plastic	M12 Connector	NPN-NC
SCB22MP5PC1	Dia 22 mm	10-30 V DC, Stay Put	Touch	Button	Plastic	1 Metre Cable	PNP-NO
SCB22MP5PSX	Dia 22 mm	10-30 V DC, Stay Put	Touch	Button	Plastic	M12 Connector	PNP-NO
SCB22MP5RC1	Dia 22 mm	10-30 V DC, Stay Put	Touch	Button	Plastic	1 Metre Cable	PNP-NC
SCB22MP5RSX	Dia 22 mm	10-30 V DC, Stay Put	Touch	Button	Plastic	M12 Connector	PNP-NC



SPM18DP4DC2

**Photoelectric Proximity Switches (4 Wire), IP65**

Code	Body Type	Voltage	Sensing Distance	Operating Type	Response Time	Connection	Output
SPM18DP4DC2	Cylinder 18	10-30 V DC	400mm	Diffuse Reflection	2ms	Wire Connection(2m)	PNP 1NO+1NC
SPM18DP4EC2	Cylinder 18	10-30 V DC	400mm	Diffuse Reflection	2ms	Wire Connection(2m)	NPN 1NO+1NC



**Magnetic Switch, IP68**

Code	Body Type	Contact Type	Mounting-Type	Connection	Features	Sensing Distance	Box/Pcs
SMB10LC2-B1*	Rectangular 78 mm	1NC+1NO	Left Exit	Wire Connection (2m)		5 mm / 8 mm	1
SMB10LSZ-B1*	Rectangular 78 mm	1NC+1NO	Left Exit	M8*4 Connection		5 mm / 8 mm	1
SMB10MC2-B1*	Rectangular 78 mm	1NC+1NO	Upright Exit	Wire Connection (2m)		5 mm / 8 mm	1
SMB10MSZ-B1*	Rectangular 78 mm	1NC+1NO	Upright Exit	M8*4 Connection		5 mm / 8 mm	1
SMB10RC2-B1*	Rectangular 78 mm	1NC+1NO	Right Exit	Wire Connection (2m)		5 mm / 8 mm	1
SMB10RSZ-B1*	Rectangular 78 mm	1NC+1NO	Right Exit	M8*4 Connection		5 mm / 8 mm	1
SMB11LC2-B1*	Rectangular 78 mm	1NC+1NO	Left Exit	Wire Connection (2m)	LED	5 mm / 8 mm	1
SMB11LSX-B1*	Rectangular 78 mm	1NC+1NO	Left Exit	M12*8 Connection	LED	5 mm / 8 mm	1
SMB11MC2-B1*	Rectangular 78 mm	1NC+1NO	Upright Exit	Wire Connection (2m)	LED	5 mm / 8 mm	1
SMB11MSX-B1*	Rectangular 78 mm	1NC+1NO	Upright Exit	M12*8 Connection	LED	5 mm / 8 mm	1
SMB11RC2-B1*	Rectangular 78 mm	1NC+1NO	Right Exit	Wire Connection (2m)	LED	5 mm / 8 mm	1
SMB11RSX-B1*	Rectangular 78 mm	1NC+1NO	Right Exit	M12*8 Connection	LED	5 mm / 8 mm	1
SMB20LC2-B2*	Rectangular 78 mm	2NC	Left Exit	Wire Connection (2m)		5 mm / 8 mm	1
SMB20LSZ-B2*	Rectangular 78 mm	2NC	Left Exit	M8*4 Connection		5 mm / 8 mm	1
SMB20MC2-B2*	Rectangular 78 mm	2NC	Upright Exit	Wire Connection (2m)		5 mm / 8 mm	1
SMB20MSZ-B2*	Rectangular 78 mm	2NC	Upright Exit	M8*4 Connection		5 mm / 8 mm	1
SMB20RC2-B2*	Rectangular 78 mm	2NC	Right Exit	Wire Connection (2m)		5 mm / 8 mm	1
SMB20RSZ-B2*	Rectangular 78 mm	2NC	Right Exit	M8*4 Connection		5 mm / 8 mm	1
SMB21LC2-B2*	Rectangular 78 mm	2NC	Left Exit	Wire Connection (2m)	LED	5 mm / 8 mm	1
SMB21LSX-B2*	Rectangular 78 mm	2NC	Left Exit	M12*8 Connection	LED	5 mm / 8 mm	1
SMB21MC2-B2*	Rectangular 78 mm	2NC	Upright Exit	Wire Connection (2m)	LED	5 mm / 8 mm	1
SMB21MSX-B2*	Rectangular 78 mm	2NC	Upright Exit	M12*8 Connection	LED	5 mm / 8 mm	1
SMB21RC2-B2*	Rectangular 78 mm	2NC	Right Exit	Wire Connection (2m)	LED	5 mm / 8 mm	1
SMB21RSX-B2*	Rectangular 78 mm	2NC	Right Exit	M12*8 Connection	LED	5 mm / 8 mm	1
SMB30LC2-B3*	Rectangular 78 mm	2NC+NO	Left Exit	Wire Connection (2m)		5 mm / 8 mm	1
SMB30LSX-B3*	Rectangular 78 mm	2NC+NO	Left Exit	M12*8 Connection		5 mm / 8 mm	1
SMB30MC2-B3*	Rectangular 78 mm	2NC+NO	Upright Exit	Wire Connection (2m)		5 mm / 8 mm	1
SMB30MSX-B3*	Rectangular 78 mm	2NC+NO	Upright Exit	M12*8 Connection		5 mm / 8 mm	1
SMB30RC2-B3*	Rectangular 78 mm	2NC+NO	Right Exit	Wire Connection (2m)		5 mm / 8 mm	1
SMB30RSX-B3*	Rectangular 78 mm	2NC+NO	Right Exit	M12*8 Connection		5 mm / 8 mm	1
SMB31LC2-B3*	Rectangular 78 mm	2NC+NO	Left Exit	Wire Connection (2m)	LED	5 mm / 8 mm	1
SMB31LSX-B3*	Rectangular 78 mm	2NC+NO	Left Exit	M12*8 Connection	LED	5 mm / 8 mm	1
SMB31MC2-B3*	Rectangular 78 mm	2NC+NO	Upright Exit	Wire Connection (2m)	LED	5 mm / 8 mm	1
SMB31MSX-B3*	Rectangular 78 mm	2NC+NO	Upright Exit	M12*8 Connection	LED	5 mm / 8 mm	1
SMB31RC2-B3*	Rectangular 78 mm	2NC+NO	Right Exit	Wire Connection (2m)	LED	5 mm / 8 mm	1
SMB31RSX-B3*	Rectangular 78 mm	2NC+NO	Right Exit	M12*8 Connection	LED	5 mm / 8 mm	1
SMS10LC2-S1*	Rectangular 22 mm	1NC+1NO	Left Exit	Wire Connection (2m)		5 mm / 8 mm	1
SMS10LSZ-S1*	Rectangular 22 mm	1NC+1NO	Left Exit	M8*4 Connection		5 mm / 8 mm	1
SMS10RC2-S1*	Rectangular 22 mm	1NC+1NO	Right Exit	Wire Connection (2m)		5 mm / 8 mm	1
SMS10RSZ-S1*	Rectangular 22 mm	1NC+1NO	Right Exit	M8*4 Connection		5 mm / 8 mm	1
SMS11LC2-S1*	Rectangular 22 mm	1NC+1NO	Left Exit	Wire Connection (2m)	LED	5 mm / 8 mm	1
SMS11LSX-S1*	Rectangular 22 mm	1NC+1NO	Left Exit	M12*8 Connection	LED	5 mm / 8 mm	1
SMS11RC2-S1*	Rectangular 22 mm	1NC+1NO	Right Exit	Wire Connection (2m)	LED	5 mm / 8 mm	1
SMS11RSX-S1*	Rectangular 22 mm	1NC+1NO	Right Exit	M12*8 Connection	LED	5 mm / 8 mm	1
SMS20LC2-S2*	Rectangular 22 mm	2NC	Left Exit	Wire Connection (2m)		5 mm / 8 mm	1
SMS20LSZ-S2*	Rectangular 22 mm	2NC	Left Exit	M8*4 Connection		5 mm / 8 mm	1

Note 1: SMB10LC2-B1\* code means Actuator and Switch together. Switch code is SMB10LC2, Actuator code is SMB15.

Note 2 : \* Refers to Sensing Distance, If it is 5, it means 5 mm sensing distance. If it is 8, it means 8 mm sensing distance.



### Magnetic Switch, IP68

Code	Body Type	Contact Type	Mounting-Type	Connection	Features	Sensing Distance	Box/Pcs
SMS20RC2-S2*	Rectangular 22 mm	2NC	Right Exit	Wire Connection (2m)		5 mm / 8 mm	1
SMS20RSZ-S2*	Rectangular 22 mm	2NC	Right Exit	M8*4 Connection		5 mm / 8 mm	1
SMS21LC2-S2*	Rectangular 22 mm	2NC	Left Exit	Wire Connection (2m)	LED	5 mm / 8 mm	1
SMS21LSX-S2*	Rectangular 22 mm	2NC	Left Exit	M12*8 Connection	LED	5 mm / 8 mm	1
SMS21RC2-S2*	Rectangular 22 mm	2NC	Right Exit	Wire Connection (2m)	LED	5 mm / 8 mm	1
SMS21RSX-S2*	Rectangular 22 mm	2NC	Right Exit	M12*8 Connection	LED	5 mm / 8 mm	1
SMS30LC2-S3*	Rectangular 22 mm	2NC+NO	Left Exit	Wire Connection (2m)		5 mm / 8 mm	1
SMS30LSX-S3*	Rectangular 22 mm	2NC+NO	Left Exit	M12*8 Connection		5 mm / 8 mm	1
SMS30RC2-S3*	Rectangular 22 mm	2NC+NO	Right Exit	Wire Connection (2m)		5 mm / 8 mm	1
SMS30RSX-S3*	Rectangular 22 mm	2NC+NO	Right Exit	M12*8 Connection		5 mm / 8 mm	1
SMS31LC2-S3*	Rectangular 22 mm	2NC+NO	Left Exit	Wire Connection (2m)	LED	5 mm / 8 mm	1
SMS31LSX-S3*	Rectangular 22 mm	2NC+NO	Left Exit	M12*8 Connection	LED	5 mm / 8 mm	1
SMS31RC2-S3*	Rectangular 22 mm	2NC+NO	Right Exit	Wire Connection (2m)	LED	5 mm / 8 mm	1
SMS31RSX-S3*	Rectangular 22 mm	2NC+NO	Right Exit	M12*8 Connection	LED	5 mm / 8 mm	1

Note 1: SMB10LC2-B1\* code means Actuator and Switch together. Switch code is SMB10LC2, Actuator code is SMB15.

Note 2 : \* Refers to Sensing Distance, If it is 5, it means 5 mm sensing distance. If it is 8, it means 8 mm sensing distance.



### Sensor Test Device

#### Code

Sensor Tester



A54B1H10



A54B1Y10



PTM111



PTM110



A71B1K11



A14B4K11



PTM122



MN3KIM1



BS1010TX1

# Basic Switches



MN1KIM1



MN1MIM2



MN1MUM3

### MN1 Series Mini Switch

Code	Contact Type	Actuator	Actuator Material	Box/Pcs
MN1KIM1	1 CO	Lever	Metal	10
MN1KIM2	1 CO	Lever	Metal	10
MN1KIM3	1 CO	Lever	Metal	10
MN1MIM1	1 CO	Roller Lever	Metal	10
MN1MIM1Y	1 CO	Roller Lever	Metal	10
MN1MIM2	1 CO	Roller Lever	Metal	10
MN1MUM3	1 CO	Roller Plunger	Metal	10
MN1MUM8	1 CO	Roller Plunger	Metal	10
MN1MUM9	1CO	Roller Plunger	Metal	10
MN1PUM1	1 CO	Plunger	Metal	10
MN1PUM3	1 CO	Plunger	Metal	10
MN1PUM7	1 CO	Plunger	Metal	10
MN1PUM9	1 CO	Plunger	Metal	10
MN1PUM9U	1 CO	Plunger	Metal	10
MN1YKAP		Protection Cover	MN1, MN2	100



MN2TIP11



MN2TIP11Y



MN2MIM1Y



MN2PUM9

### MN2 Series Mini Switch

Code	Contact Type	Actuator	Actuator Material	Box/Pcs
MN2TIP11	1 NO	Handle	Plastic	10
MN2TIP11Y*	1 NO	Handle	Plastic	10
MN2TIP1	1 CO	Handle	Plastic	10
MN2KIM1	1 CO	Lever	Metal	10
MN2KIM2	1 CO	Lever	Metal	10
MN2KIM3	1 CO	Lever	Metal	10
MN2MIM1	1 CO	Roller Lever	Metal	10
MN2MIM1Y	1 CO	Roller Lever	Metal	10
MN2MIM2	1 CO	Roller Lever	Metal	10
MN2MUM3	1 CO	Roller Plunger	Metal	10
MN2MUM8	1 CO	Roller Plunger	Metal	10
MN2PUM1	1 CO	Plunger	Metal	10
MN2PUM3	1 CO	Plunger	Metal	10
MN2PUM7	1 CO	Plunger	Metal	10
MN2PUM9	1 CO	Plunger	Metal	10

\* Hardened spring and green button.

NEW



MN3KIM1

NEW



MN3PUM9

### MN3 Series Mini Switch (Metal), IP65

Code	Contact Type	Actuator	Actuator Material	Box/Pcs
MN3KIM1	1 CO	Lever	Metal	10
MN3KIM2	1 CO	Lever	Metal	10
MN3MIM1	1 CO	Roller Lever	Metal	10
MN3MIM2	1 CO	Roller Lever	Metal	10
MN3MUM3	1 CO	Roller Plunger	Metal	10
MN3PUM1	1 CO	Plunger	Metal	10
MN3PUM3	1 CO	Plunger	Metal	10
MN3PUM7	1 CO	Plunger	Metal	10
MN3PUM9	1 CO	Plunger	Metal	10



MN4KIM2



MN4MUM3



MN4PUP1

## MN4 Series Mini Switch

Code	Contact Type	Actuator	Actuator Material	Box/Pcs
MN4KIM1	1 NC+1 NO	Lever	Metal	10
MN4KIM2	1 NC+1 NO	Lever	Metal	10
MN4KIM3	1 NC+1 NO	Lever	Metal	10
MN4MIM1	1 NC+1 NO	Roller Lever	Metal	10
MN4MIM1Y	1 NC+1 NO	Roller Lever	Metal	10
MN4MIM2	1 NC+1 NO	Roller Lever	Metal	10
MN4MUM3	1 NC+1 NO	Roller Plunger	Metal	10
MN4MUM8	1 NC+1 NO	Roller Plunger	Metal	10
MN4PUP1	1 NC+1 NO	Plunger	Plastic	10
MN4PUM7	1 NC+1 NO	Plunger	Metal	10
MN4PUM9	1 NC+1 NO	Plunger	Metal	10



MK1PUP1



MK1KIM1



MK1KIM5



MK1MIP3



MK1PUM9



MK1KIM31A

## Micro Switch

Code	Contact Type	Actuator	Actuator Material	Box/Pcs
MK1PUM9	1 CO	Plunger	Metal	10
MK1PUP1	1 CO	Plunger	Plastic	50
MK1PUP1Y	1 CO	Plunger	Soft Plastic	50
MK1KIM1	1 CO	Lever	Metal	50
MK1KIM2	1 CO	Lever	Metal	50
MK1KIM3	1 CO	Lever	Metal	50
MK1KIM31A	1 NC	Lever	Metal	50
MK1KIM4	1 CO	Lever	Metal	50
MK1KIM5	1 CO	Lever	Metal	40
MK1MIM1	1 CO	Roller Lever	Metal	40
MK1MIM2	1 CO	Roller Lever	Metal	40
MK1MIP1	1 CO	Roller Lever	Metal	50
MK1MIP2	1 CO	Roller Lever	Plastic	40
MK1MIP3	1 CO	Roller Lever	Plastic	40



BS1022



BS1012



BS1010E



BS1012E

## Button Switch, IP50

Code	Contact Type	Actuator	Actuator Material	Box/Pcs
BS1010	1 NO, Snap Action	Plunger	Plastic	20
BS1010E	1 NO, Snap Action	Plunger	Plastic with Silicon Cover	16
BS1011	1 NC, Snap Action	Plunger	Plastic	20
BS1011E	1 NC, Snap Action	Plunger	Plastic with Silicon Cover	16
BS1012	1NO+1NC, Snap Action	Plunger	Plastic	20
BS1012E	1NO+1NC, Snap Action	Plunger	Plastic with Silicon Cover	16
BS1020	1 NO, Slow Action	Plunger	Plastic	20
BS1021	1 NC, Slow Action	Plunger	Plastic	20
BS1022	1NO+1NC, Snap Action	Plunger	Plastic	20



BS1010TX1

## Button Switches, IP 67

Code	Contact Type	Cable Length	Actuator	Actuator Material	Box/Pcs
BS1010TX1	1NO, Snap Action	1m	Plunger	Plastic, With Silicon Cap	1
BS1011TX1	1NC, Snap Action	1m	Plunger	Plastic, With Silicon Cap	1
BS1012TX1	Double Circuit, Snap Action	1m	Plunger	Plastic, With Silicon Cap	1





MA111



MA121



MA111K



MAK

## Toggle Switch

Code	Contact Type	Cable Connection	Actuator Material	Plate	Box/Pcs
MA111	1 NO	2 Screws	Metal	On-Off	10
MA111L	1 NO	2 Soldering Terminals	Metal	On-Off	10
MA111T	1 NO	2 Terminals	Metal	On-Off	10
MA111TT	1 NO	2 Terminals	Metal	On-Off (Black)	10
MA112	1 NO, 1 NC	3 Screws	Metal	On-On	10
MA113	1 NO, 1 NO	3 Screws	Metal	On-Off-On	10
MA121	2 NO	4 Screws	Metal	On-Off	6
MA122	2 NO + 2 NC	6 Screws	Metal	On-On	6
MA123	2 NO + 2 NO	6 Screws	Metal	On-Off-On	6
MA211	1 NO	2 Screws	Metal, Plastic Covered	On-Off	10
MA212	1 NO + 1 NC	3 Screws	Metal, Plastic Covered	On-On	10
MA212T	1 NO + 1 NC	3 Terminals	Metal, Plastic Covered	On-On	10
MA213	1 NO + 1 NO	3 Screws	Metal, Plastic Covered	On-Off-On	10
MA213T	1 NO + 1 NO	3 Terminals	Metal, Plastic Covered	On-Off-On	10
MA221	2 NO	4 Screws	Metal, Plastic Covered	On-Off	6
MA222	2 NO + 2 NC	6 Screws	Metal, Plastic Covered	On-On	6
MA222T	2 NO + 2 NC	6 Terminals	Metal, Plastic Covered	On-On	6
MA223	2 NO + 2 NO			On-Off-On	6
MA513T	1 NO + 1 NO	3 Terminals	Plastic	On-Off-On	10
MA513V	1 NO + 1 NO	3 Screws	Plastic	On-Off-On	10
MAK	-	-	Plastic	-	10



MAY111



MAY121



MAY123



MAY222

## Toggle Switch, Spring Return

Code	Contact Type	Cable Connection	Actuator Material	Plate	Box/Pcs
MAY111	1 NO	2 Screws	Metal	On-Off	10
MAY111L	1 NO	2 Soldering Terminals	Metal	On-Off	10
MAY111T	1 NO	2 Terminals	Metal	On-Off	10
MAY111TT	1 NO	2 Terminals	Metal	On-Off (Black)	10
MAY112	1 NO, 1 NC	3 Screws	Metal	On-On	10
MAY113	1 NO, 1 NO	3 Screws	Metal	On-Off-On	10
MAY121	2 NO	4 Screws	Metal	On-Off	6
MAY122	2 NO + 2 NC	6 Screws	Metal	On-On	6
MAY123	2 NO + 2 NO	6 Screws	Metal	On-Off-On	6
MAY211	1 NO	2 Screws	Metal, Plastic Covered	On-Off	10
MAY212	1 NO + 1 NC	3 Screws	Metal, Plastic Covered	On-On	10
MAY212T	1 NO + 1 NC	3 Terminals	Metal, Plastic Covered	On-On	10
MAY213	1 NO + 1 NO	3 Screws	Metal, Plastic Covered	On-Off-On	10
MAY213T	1 NO + 1 NO	3 Terminals	Metal, Plastic Covered	On-Off-On	10
MAY221	2 NO	4 Screws	Metal, Plastic Covered	On-Off	6
MAY222	2 NO + 2 NC	6 Screws	Metal, Plastic Covered	On-On	6
MAY222T	2 NO + 2 NC	6 Terminals	Metal, Plastic Covered	On-On	6
MA223	2 NO + 2 NO			On-Off-On	6



K25001T



K25011V

### Medium Voltage Cell Switches

Code	Contact Type	Terminal Type	Box/Pcs
K25001T	2 NC, 1 NO	6 Terminals	10
K25001V	2 NC, 1 NO	6 Screws	10
K25011T	1 NC, 2 NO	6 Terminals	10
K25011V	1 NC, 2 NO	6 Screws	10



Z70



Z71

### Elevator Door Switches

Code	Type	Box/Pcs
Z70	Plug	16
Z71	Socket Single Entry	16
Z72	Socket Double Entry	16
Z73	Plug	16
Z74	Socket Single Entry	16



Z72



Z73



Z74



A21B1K11



A12W1K11



A54B1H10



A14B1K11



A54B1Y11



A71B1K11

## Illuminated Rocker Switch

Code	Housing Type	Housing Colour	Feature	Contact Type	Plate	Button Colour	Cable Connection	Box/Pcs
A12B1H10	30*22mm	Black	WO/Illumination	1NO + 1NO	0-1	H	Terminal	50
A12B1K11	30*22mm	Black	W/Illumination	1NO + 1NO	0-1	K	Terminal	50
A12B1S11	30*22mm	Black	W/Illumination	1NO + 1NO	0-1	S	Terminal	50
A12B1Y11	30*22mm	Black	W/Illumination	1NO + 1NO	0-1	Y	Terminal	50
A12B5H10	30*22mm	Black	WO/Illumination	1NO + 1NO	0-1	H	Bridge	50
A12B5K11	30*22mm	Black	W/Illumination	1NO + 1NO	0-1	K	Bridge	50
A12B5S11	30*22mm	Black	W/Illumination	1NO + 1NO	0-1	S	Bridge	50
A12B5Y11	30*22mm	Black	W/Illumination	1NO + 1NO	0-1	Y	Bridge	50
A12W1H10	30*22mm	White	WO/Illumination	1NO + 1NO	0-1	H	Terminal	50
A12W1K11	30*22mm	White	W/Illumination	1NO + 1NO	0-1	K	Terminal	50
A12W1S11	30*22mm	White	W/Illumination	1NO + 1NO	0-1	S	Terminal	50
A12W1Y11	30*22mm	White	W/Illumination	1NO + 1NO	0-1	Y	Terminal	50
A14B1H10	30*22mm	Black	WO/Illumination	2NO	0-1	H	Terminal	50
A14B1K11	30*22mm	Black	W/Illumination	2NO	0-1	K	Terminal	50
A14B1S11	30*22mm	Black	W/Illumination	2NO	0-1	S	Terminal	50
A14B1Y11	30*22mm	Black	W/Illumination	2NO	0-1	Y	Terminal	50
A14B4H10	30*22mm	Black	WO/Illumination	2NO	0-1	H	Screw	50
A14B4K11	30*22mm	Black	W/Illumination	2NO	0-1	K	Screw	50
A14B4S11	30*22mm	Black	W/Illumination	2NO	0-1	S	Screw	50
A14B4Y11	30*22mm	Black	W/Illumination	2NO	0-1	Y	Screw	50
A14B5H10	30*22mm	Black	WO/Illumination	2NO	0-1	H	Bridge	50
A14B5K11	30*22mm	Black	W/Illumination	2NO	0-1	K	Bridge	50
A14B5S11	30*22mm	Black	W/Illumination	2NO	0-1	S	Bridge	50
A14B5Y11	30*22mm	Black	W/Illumination	2NO	0-1	Y	Bridge	50
A14B6H10	30*22mm	Black	WO/Illumination	2NO	0-1	H	Protected Screw	50
A14B6K11	30*22mm	Black	W/Illumination	2NO	0-1	K	Protected Screw	50
A14B6S11	30*22mm	Black	W/Illumination	2NO	0-1	S	Protected Screw	50
A14B6Y11	30*22mm	Black	W/Illumination	2NO	0-1	Y	Protected Screw	50
A14W1K11	30*22mm	White	W/Illumination	2NO	0-1	K	Terminal	50
A14W1S11	30*22mm	White	W/Illumination	2NO	0-1	S	Terminal	50
A14W1Y11	30*22mm	White	W/Illumination	2NO	0-1	Y	Terminal	50
A21B1H10	30*11mm	Black	WO/Illumination	1NO	0-1	H	Terminal	50
A21B1K11	30*11mm	Black	W/Illumination	1NO	0-1	K	Terminal	50
A21B1S11	30*11mm	Black	W/Illumination	1NO	0-1	S	Terminal	50
A21B1Y11	30*11mm	Black	W/Illumination	1NO	0-1	Y	Terminal	50
A21W1K11	30*11mm	White	W/Illumination	1NO	0-1	K	Terminal	50
A21W1S11	30*11mm	White	W/Illumination	1NO	0-1	S	Terminal	50
A21W1Y11	30*11mm	White	W/Illumination	1NO	0-1	Y	Terminal	50
A54B1H10	30*22mm	Black	WO/Illumination IP65	2NO	0-1	H	Terminal	50
A54B1K11	30*22mm	Black	W/Illumination IP65	2NO	0-1	K	Terminal	50
A54B1S11	30*22mm	Black	W/Illumination IP65	2NO	0-1	S	Terminal	50
A54B1Y11	30*22mm	Black	W/Illumination IP65	2NO	0-1	Y	Terminal	50
A71B1H10	Dia 22mm	Black	WO/Illumination	1NO	0-1	H	Terminal	50
A71B1K11	Dia 22mm	Black	W/Illumination	1NO	0-1	K	Terminal	50
A71B1S11	Dia 22mm	Black	W/Illumination	1NO	0-1	S	Terminal	50
A71B1Y11	Dia 22mm	Black	W/Illumination	1NO	0-1	Y	Terminal	50

Code	Type	Box/Pcs
EK1	Silicon Cover, Tight	100
EK2	Silicon Cover, Wide	100



EK1



EK2



PTM110



PTM111



PTM122

## Panel Thermostats

Code	Operation	Type	Contact	Box/Pcs
PTM110	Mechanical	Panel Type Single	NC (Heating-Red)	1
PTM111	Mechanical	Panel Type Single	NO (Cooling-Blue)	1
PTM122	Mechanical	Panel Type Double	NC (Heating-Red)+NO (Cooling-Blue)	1



PSA020AK131K



PSA020AK131AQ



PSR2



PSA020KS134Q

PSA080AK231S



PSA080AK241E



PSA020KS133Q



PSK32



PSK31

# Rotary Cam Switches

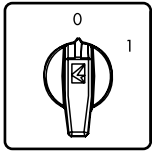

PSA020AK131S

## "0-1" On-Off Cam Switches - 60°

Code	Poles	Rated Thermal Current (A)	Enclosure	Key Operated	Quick Installation	Scheme
PSA010AK131S	1 Pole	10	PSK11	✓	✓	
PSA016AK131S	1 Pole	16	PSK11	✓	✓	
PSA020AK131S	1 Pole	20	PSK11	✓	✓	
PSA025AK131S	1 Pole	25	PSK11	✓	✓	
PSA032AK131S	1 Pole	32	PSK21			
PSA040AK131S	1 Pole	40	PSK21			
PSA050AK131S	1 Pole	50	PSK31			
PSA063AK131S	1 Pole	63	PSK31			
PSA080AK131S	1 Pole	80	-			
PSA120AK131S	1 Pole	120	-			



PSA020AK231S

PSA010AK231S	2 Poles	10	PSK11	✓	✓	
PSA016AK231S	2 Poles	16	PSK11	✓	✓	
PSA020AK231S	2 Poles	20	PSK11	✓	✓	
PSA025AK231S	2 Poles	25	PSK11	✓	✓	
PSA032AK231S	2 Poles	32	PSK21			
PSA040AK231S	2 Poles	40	PSK21			
PSA050AK231S	2 Poles	50	PSK31			
PSA063AK231S	2 Poles	63	PSK31			
PSA080AK231S	2 Poles	80	-			
PSA120AK231S	2 Poles	120	-			



PSA020AK331S

PSA010AK331S	3 Poles	10	PSK11	✓	✓	
PSA016AK331S	3 Poles	16	PSK11	✓	✓	
PSA020AK331S	3 Poles	20	PSK11	✓	✓	
PSA025AK331S	3 Poles	25	PSK11	✓	✓	
PSA032AK331S	3 Poles	32	PSK21			
PSA040AK331S	3 Poles	40	PSK21			
PSA050AK331S	3 Poles	50	PSK31			
PSA063AK331S	3 Poles	63	PSK31			
PSA080AK331S	3 Poles	80	-			
PSA120AK331S	3 Poles	120	-			



PSA020AK431S

PSA010AK431S	4 Poles	10	PSK11	✓	✓	
PSA016AK431S	4 Poles	16	PSK11	✓	✓	
PSA020AK431S	4 Poles	20	PSK11	✓	✓	
PSA025AK431S	4 Poles	25	PSK11	✓	✓	
PSA032AK431S	4 Poles	32	PSK21			
PSA040AK431S	4 Poles	40	PSK21			
PSA050AK431S	4 Poles	50	PSK31			
PSA063AK431S	4 Poles	63	PSK31			
PSA080AK431S	4 Poles	80	-			
PSA120AK431S	4 Poles	120	-			

PSA010AK531S	5 Poles	10	PSK12	✓	✓	
PSA016AK531S	5 Poles	16	PSK12	✓	✓	
PSA020AK531S	5 Poles	20	PSK12	✓	✓	
PSA025AK531S	5 Poles	25	PSK12	✓	✓	
PSA032AK531S	5 Poles	32	PSK22			
PSA040AK531S	5 Poles	40	PSK22			
PSA050AK531S	5 Poles	50	PSK32			
PSA063AK531S	5 Poles	63	PSK32			
PSA080AK531S	5 Poles	80	-			
PSA120AK531S	5 Poles	120	-			

\* Can be supplied with Red-Yellow head w/o extra charge, in this case please replace "S" at the end with "E".

\*\* 10-25A Cam Switches can be supplied with big frame (64 x 64) with extra charge, In this case please replace the "S" at the end with "B".

\*\*\* Products are in the key operated columns are suitable for Quick Installation key head with extra charge. In this case, replace "S" letter at the end of the code with "AQ".

\*\*\*\* Please replace "S" letter at the end of the code with "K" for Lockable Handle model (with extra charge)

\*\*\*\*\* Please replace "S" letter at the end of the code with "Q" for Quick Installation model (with extra charge)





PSA020AK831S

## "0-1" On-Off Cam Switches - 60°

Code	Poles	Rated Thermal Current (A)	Enclosure	Key Operated	Quick Installation	Scheme
PSA010AK831S	3 Poles+Neutral	10	PSK11	✓	✓	
PSA016AK831S	3 Poles+Neutral	16	PSK11	✓	✓	
PSA020AK831S	3 Poles+Neutral	20	PSK11	✓	✓	
PSA025AK831S	3 Poles+Neutral	25	PSK11	✓	✓	
PSA032AK831S	3 Poles+Neutral	32	PSK21			
PSA040AK831S	3 Poles+Neutral	40	PSK21			
PSA050AK831S	3 Poles+Neutral	50	PSK31			
PSA063AK831S	3 Poles+Neutral	63	PSK31			
PSA080AK831S	3 Poles+Neutral	80	-			
PSA120AK831S	3 Poles+Neutral	120	-			

\* Can be supplied with Red-Yellow head w/o extra charge, in this case please replace "S" at the end with "E".

\*\* 10-25A Cam Switches can be supplied with big frame (64 x 64) with extra charge, In this case please replace the "S" at the end with "B".

\*\*\* Products are in the key operated columns are suitable for Quick Installation key head with extra charge. In this case, replace "S" letter at the end of the code with "AQ".

\*\*\*\* Please replace "S" letter at the end of the code with "K" for Lockable Handle model (with extra charge)

\*\*\*\*\* Please replace "S" letter at the end of the code with "Q" for Quick Installation model (with extra charge)

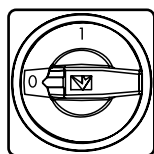

PSA020AK141E

## "0-1" Safety On-Off Cam Switches - 90°

Code	Poles	Rated Thermal Current (A)	Enclosure	Key Operated	Quick Installation	Scheme
PSA010AK141E	1 Pole	10	PSK11		✓	
PSA016AK141E	1 Pole	16	PSK11		✓	
PSA020AK141E	1 Pole	20	PSK11		✓	
PSA025AK141E	1 Pole	25	PSK11		✓	
PSA032AK141E	1 Pole	32	PSK21			
PSA040AK141E	1 Pole	40	PSK21			
PSA050AK141E	1 Pole	50	PSK31			
PSA063AK141E	1 Pole	63	PSK31			
PSA080AK141E	1 Pole	80	-			
PSA120AK141E	1 Pole	120	-			



PSA020AK241E

PSA010AK241E	2 Poles	10	PSK11		✓	
PSA016AK241E	2 Poles	16	PSK11		✓	
PSA020AK241E	2 Poles	20	PSK11		✓	
PSA025AK241E	2 Poles	25	PSK11		✓	
PSA032AK241E	2 Poles	32	PSK21			
PSA040AK241E	2 Poles	40	PSK21			
PSA050AK241E	2 Poles	50	PSK31			
PSA063AK241E	2 Poles	63	PSK31			
PSA080AK241E	2 Poles	80	-			
PSA120AK241E	2 Poles	120	-			



PSA020AK341E

PSA010AK341E	3 Poles	10	PSK11		✓	
PSA016AK341E	3 Poles	16	PSK11		✓	
PSA020AK341E	3 Poles	20	PSK11		✓	
PSA025AK341E	3 Poles	25	PSK11		✓	
PSA032AK341E	3 Poles	32	PSK21			
PSA040AK341E	3 Poles	40	PSK21			
PSA050AK341E	3 Poles	50	PSK31			
PSA063AK341E	3 Poles	63	PSK31			
PSA080AK341E	3 Poles	80	-			
PSA120AK341E	3 Poles	120	-			



PSA020AK441E

## "0-1" Safety On-Off Cam Switches - 90°

Code	Poles	Rated Thermal Current (A)	Enclosure	Key Operated	Quick Installation	Scheme
PSA010AK441E	4 Poles	10	PSK11		✓	
PSA016AK441E	4 Poles	16	PSK11		✓	
PSA020AK441E	4 Poles	20	PSK11		✓	
PSA025AK441E	4 Poles	25	PSK11		✓	
PSA032AK441E	4 Poles	32	PSK21			
PSA040AK441E	4 Poles	40	PSK21			
PSA050AK441E	4 Poles	50	PSK31			
PSA063AK441E	4 Poles	63	PSK31			
PSA080AK441E	4 Poles	80	-			
PSA120AK441E	4 Poles	120	-			

PSA010AK541E	5 Poles	10	PSK12		✓	
PSA016AK541E	5 Poles	16	PSK12		✓	
PSA020AK541E	5 Poles	20	PSK12		✓	
PSA025AK541E	5 Poles	25	PSK12		✓	
PSA032AK541E	5 Poles	32	PSK22			
PSA040AK541E	5 Poles	40	PSK22			
PSA050AK541E	5 Poles	50	PSK32			
PSA063AK541E	5 Poles	63	PSK32			
PSA080AK541E	5 Poles	80	-			
PSA120AK541E	5 Poles	120	-			

PSA010AK641E	6 Poles	10	PSK12		✓	
PSA016AK641E	6 Poles	16	PSK12		✓	
PSA020AK641E	6 Poles	20	PSK12		✓	
PSA025AK641E	6 Poles	25	PSK12		✓	
PSA032AK641E	6 Poles	32	PSK22			
PSA040AK641E	6 Poles	40	PSK22			
PSA050AK641E	6 Poles	50	PSK32			
PSA063AK641E	6 Poles	63	PSK32			
PSA080AK641E	6 Poles	80	-			
PSA120AK641E	6 Poles	120	-			



PSA020AK941E

PSA010AK941E	3 Poles+Neutral	10	PSK11		✓	
PSA016AK941E	3 Poles+Neutral	16	PSK11		✓	
PSA020AK941E	3 Poles+Neutral	20	PSK11		✓	
PSA025AK941E	3 Poles+Neutral	25	PSK11		✓	
PSA032AK941E	3 Poles+Neutral	32	PSK21			
PSA040AK941E	3 Poles+Neutral	40	PSK21			
PSA050AK941E	3 Poles+Neutral	50	PSK31			
PSA063AK941E	3 Poles+Neutral	63	PSK31			
PSA080AK941E	3 Poles+Neutral	80	-			
PSA120AK941E	3 Poles+Neutral	120	-			

\*10-25A Cam Switches can be supplied with big frame (64 x 64) with extra charge, in this case please replace the "E" at the end with "F"

\*\* Please replace "E" letter at the end of the code with "P" for Quick Installation model (with extra charge)

## 1-2 Changeover Cam Switches - 60°

Code	Poles	Rated Thermal Current (A)	Enclosure	Key Operated	Quick Installation	Scheme
PSA010KD133S	1 Pole	10	PSK11	✓	✓	
PSA016KD133S	1 Pole	16	PSK11	✓	✓	
PSA020KD133S	1 Pole	20	PSK11	✓	✓	
PSA025KD133S	1 Pole	25	PSK11	✓	✓	
PSA032KD133S	1 Pole	32	PSK21			
PSA040KD133S	1 Pole	40	PSK21			
PSA050KD133S	1 Pole	50	PSK31			
PSA063KD133S	1 Pole	63	PSK31			
PSA080KD133S	1 Pole	80	-			
PSA120KD133S	1 Pole	120	-			

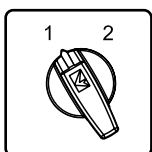

PSA020KD133S

## "1-2" Changeover Cam Switches - 60°

Code	Poles	Rated Thermal Current (A)	Enclosure	Key Operated	Quick Installation	Scheme
PSA010KD233S	2 Poles	10	PSK11	✓	✓	
PSA016KD233S	2 Poles	16	PSK11	✓	✓	
PSA020KD233S	2 Poles	20	PSK11	✓	✓	
PSA025KD233S	2 Poles	25	PSK11	✓	✓	
PSA032KD233S	2 Poles	32	PSK31			
PSA040KD233S	2 Poles	40	PSK31			
PSA050KD233S	2 Poles	50	-			
PSA063KD233S	2 Poles	63	-			
PSA080KD233S	2 Poles	80	-			
PSA120KD233S	2 Poles	120	-			



PSA020KD333S

PSA010KD333S	3 Poles	10	PSK12	✓	✓	
PSA016KD333S	3 Poles	16	PSK12	✓	✓	
PSA020KD333S	3 Poles	20	PSK12	✓	✓	
PSA025KD333S	3 Poles	25	PSK12	✓	✓	
PSA032KD333S	3 Poles	32	PSK31			
PSA040KD333S	3 Poles	40	PSK31			
PSA050KD333S	3 Poles	50	-			
PSA063KD333S	3 Poles	63	-			
PSA080KD333S	3 Poles	80	-			
PSA120KD333S	3 Poles	120	-			

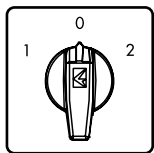

PSA020KD134S

## "1-0-2" Changeover Cam Switches - 60°

Code	Poles	Rated Thermal Current (A)	Enclosure	Key Operated	Quick Installation	Scheme
PSA010KD134S	1 Pole	10	PSK11	✓	✓	
PSA016KD134S	1 Pole	16	PSK11	✓	✓	
PSA020KD134S	1 Pole	20	PSK11	✓	✓	
PSA025KD134S	1 Pole	25	PSK11	✓	✓	
PSA032KD134S	1 Pole	32	PSK21			
PSA040KD134S	1 Pole	40	PSK21			
PSA050KD134S	1 Pole	50	PSK31			
PSA063KD134S	1 Pole	63	PSK31			
PSA080KD134S	1 Pole	80	-			
PSA120KD134S	1 Pole	120	-			



PSA020KD234S

PSA010KD234S	2 Poles	10	PSK11	✓	✓	
PSA016KD234S	2 Poles	16	PSK11	✓	✓	
PSA020KD234S	2 Poles	20	PSK11	✓	✓	
PSA025KD234S	2 Poles	25	PSK11	✓	✓	
PSA032KD234S	2 Poles	32	PSK21			
PSA040KD234S	2 Poles	40	PSK21			
PSA050KD234S	2 Poles	50	PSK31			
PSA063KD234S	2 Poles	63	PSK31			
PSA080KD234S	2 Poles	80	-			
PSA120KD234S	2 Poles	120	-			



PSA020KD334S

PSA010KD334S	3 Poles	10	PSK12	✓	✓	
PSA016KD334S	3 Poles	16	PSK12	✓	✓	
PSA020KD334S	3 Poles	20	PSK12	✓	✓	
PSA025KD334S	3 Poles	25	PSK12	✓	✓	
PSA032KD334S	3 Poles	32	PSK22			
PSA040KD334S	3 Poles	40	PSK22			
PSA050KD334S	3 Poles	50	PSK32			
PSA063KD334S	3 Poles	63	PSK32			
PSA080KD334S	3 Poles	80	-			
PSA120KD334S	3 Poles	120	-			

\* Can be supplied with Red-Yellow head w/o extra charge, in this case please replace "S" at the end with "E".

\*\* 10-25A Cam Switches can be supplied with big frame (64 x 64) with extra charge, In this case please replace the "S" at the end with "B"

\*\*\* Products are in the key operated columns are suitable for Quick Installation key head with extra charge. In this case, replace "S" letter at the end of the code with "AQ".

\*\*\*\* Please replace "S" letter at the end of the code with "Q" for Quick Installation model (with extra charge)



PSA020KD434S

Code	Poles	Rated Thermal Current (A)	Enclosure	Key Operated	Quick Installation	Scheme
PSA010KD434S	4 Poles	10	PSK12	✓	✓	
PSA016KD434S	4 Poles	16	PSK12	✓	✓	
PSA020KD434S	4 Poles	20	PSK12	✓	✓	
PSA025KD434S	4 Poles	25	PSK12	✓	✓	
PSA032KD434S	4 Poles	32	PSK22			
PSA040KD434S	4 Poles	40	PSK22			
PSA050KD434S	4 Poles	50	PSK32			
PSA063KD434S	4 Poles	63	PSK32			
PSA080KD434S	4 Poles	80	-			
PSA120KD434S	4 Poles	120	-			

### Step Cam Switches - 1 Pole

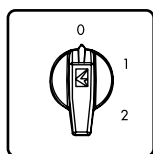

PSA020KS132S

Code	Poles	Rated Thermal Current (A)	Enclosure	Key Operated	Quick Installation	Scheme
PSA010KS132S	0-1-2	10	PSK11	✓	✓	
PSA016KS132S	0-1-2	16	PSK11	✓	✓	
PSA020KS132S	0-1-2	20	PSK11	✓	✓	
PSA025KS132S	0-1-2	25	PSK11	✓	✓	
PSA032KS132S	0-1-2	32	PSK21			
PSA040KS132S	0-1-2	40	PSK21			
PSA050KS132S	0-1-2	50	PSK31			
PSA063KS132S	0-1-2	63	PSK31			
PSA080KS132S	0-1-2	80	-			
PSA120KS132S	0-1-2	120	-			

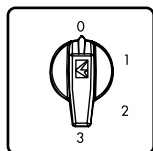

PSA020KS133S

PSA010KS133S	0-3	10	PSK11	✓	✓
PSA016KS133S	0-3	16	PSK11	✓	✓
PSA020KS133S	0-3	20	PSK11	✓	✓
PSA025KS133S	0-3	25	PSK11	✓	✓
PSA032KS133S	0-3	32	PSK21		
PSA040KS133S	0-3	40	PSK21		
PSA050KS133S	0-3	50	PSK31		
PSA063KS133S	0-3	63	PSK32		
PSA080KS133S	0-3	80	-		
PSA120KS133S	0-3	120	-		

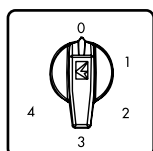

PSA020KS134S

PSA010KS134S	0-4	10	PSK12	✓	✓
PSA016KS134S	0-4	16	PSK12	✓	✓
PSA020KS134S	0-4	20	PSK12	✓	✓
PSA025KS134S	0-4	25	PSK12	✓	✓
PSA032KS134S	0-4	32	PSK22		
PSA040KS134S	0-4	40	PSK22		
PSA050KS134S	0-4	50	PSK32		
PSA063KS134S	0-4	63	PSK32		
PSA080KS134S	0-4	80	-		
PSA120KS134S	0-4	120	-		

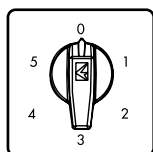

PSA020KS135S

PSA010KS135S	0-5	10	PSK12	✓	✓
PSA016KS135S	0-5	16	PSK12	✓	✓
PSA020KS135S	0-5	20	PSK12	✓	✓
PSA025KS135S	0-5	25	PSK12	✓	✓
PSA032KS135S	0-5	32	PSK22		
PSA040KS135S	0-5	40	PSK22		
PSA050KS135S	0-5	50	PSK32		
PSA063KS135S	0-5	63	PSK32		
PSA080KS135S	0-5	80	-		
PSA120KS135S	0-5	120	-		

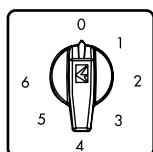

PSA020KS126S

PSA010KS126S	0-6	10	PSK12	✓	✓
PSA016KS126S	0-6	16	PSK12	✓	✓
PSA020KS126S	0-6	20	PSK12	✓	✓
PSA025KS126S	0-6	25	PSK12	✓	✓
PSA032KS126S	0-6	32	PSK22		
PSA040KS126S	0-6	40	PSK22		
PSA050KS126S	0-6	50	PSK32		
PSA063KS126S	0-6	63	PSK32		
PSA080KS126S	0-6	80	-		
PSA120KS126S	0-6	120	-		

\* Can be supplied with Red-Yellow head w/o extra charge, in this case please replace "S" at the end with "E".

\*\* 10-25A Cam Switches can be supplied with big frame (64 x 64) with extra charge, In this case please replace the "S" at the end with "B"

\*\*\* Products are in the key operated columns are suitable for Quick Installation key head with extra charge. In this case, replace "S" letter at the end of the code with "AQ".

\*\*\*\* Please replace "S" letter at the end of the code with "Q" for Quick Installation model (with extra charge)

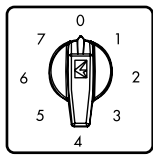

PSA020KS127S

Code	Steps	Rated Thermal Current (A)	Enclosure	Key Operated	Quick Installation	Scheme
PSA010KS127S	0-7	10	PSK12	✓	✓	
PSA016KS127S	0-7	16	PSK12	✓	✓	
PSA020KS127S	0-7	20	PSK12	✓	✓	
PSA025KS127S	0-7	25	PSK12	✓	✓	
PSA032KS127S	0-7	32	PSK22			
PSA040KS127S	0-7	40	PSK22			
PSA050KS127S	0-7	50	PSK32			
PSA063KS127S	0-7	63	PSK32			
PSA080KS127S	0-7	80	-			
PSA120KS127S	0-7	120	-			

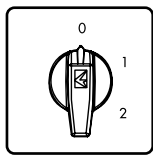

PSA020KT132S

Step Cam Switches - 60°							
Code	Poles	Rated Thermal Current (A)	Steps	Enclosure	Key Operated	Quick Installation	Scheme
PSA010KT132S	1 Pole	10	0-1-2	PSK11	✓	✓	
PSA016KT132S	1 Pole	16	0-1-2	PSK11	✓	✓	
PSA020KT132S	1 Pole	20	0-1-2	PSK11	✓	✓	
PSA025KT132S	1 Pole	25	0-1-2	PSK11	✓	✓	
PSA010KT332S	3 Poles	10	0-1-2	PSK12	✓		
PSA016KT332S	3 Poles	16	0-1-2	PSK12	✓		

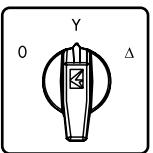

PSA020MS335S

Star-Delta Cam Switches - 60°							
Code	Steps	Rated Thermal Current (A)	Enclosure	Key Operated	Quick Installation	Scheme	
PSA010MS335S	3 Phase	10	PSK12	✓	✓		
PSA016MS335S	3 Phase	16	PSK12	✓	✓		
PSA020MS335S	3 Phase	20	PSK12	✓	✓		
PSA025MS335S	3 Phase	25	PSK12	✓	✓		
PSA032MS335S	3 Phase	32	PSK22				
PSA040MS335S	3 Phase	40	PSK22				
PSA050MS335S	3 Phase	50	PSK32				
PSA063MS335S	3 Phase	63	PSK32				
PSA080MS335S	3 Phase	80	-				
PSA120MS335S	3 Phase	120	-				

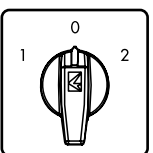

PSA020MS134S

1 Pole Change Over Cam Switches "1-0-2"							
Code	Poles	Rated Thermal Current (A)	Steps	Enclosure	Key Operated	Quick Installation	Scheme
PSA010MS134S	1 Phase	10	1-0-2	PSK11	✓	✓	
PSA016MS134S	1 Phase	16	1-0-2	PSK11	✓	✓	
PSA020MS134S	1 Phase	20	1-0-2	PSK11	✓	✓	
PSA025MS134S	1 Phase	25	1-0-2	PSK11	✓	✓	
PSA032MS134S	1 Phase	32	1-0-2	PSK21			
PSA040MS134S	1 Phase	40	1-0-2	PSK21			
PSA050MS134S	1 Phase	50	1-0-2	PSK31			
PSA063MS134S	1 Phase	63	1-0-2	PSK31			
PSA080MS134S	1 Phase	80	1-0-2	-			
PSA120MS134S	1 Phase	120	1-0-2	-			

\* Can be supplied with Red-Yellow head w/o extra charge, in this case please replace "S" at the end with "E".

\*\* 10-25A Cam Switches can be supplied with big frame (64 x 64) with extra charge, In this case please replace the "S" at the end with "B"

\*\*\* Products are in the key operated columns are suitable for Quick Installation key head with extra charge. In this case, replace "S" letter at the end of the code with "AQ".

\*\*\*\* Please replace "S" letter at the end of the code with "Q" for Quick Installation model (with extra charge)



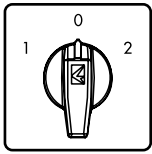

PSA020MS334S

### 3 Poles Change Over Cam Switches "1-0-2"

Code	Poles	Rated Thermal Current (A)	Steps	Enclosure	Key Operated	Quick Installation	Scheme																																			
PSA010MS334S	3 Phase	10	1-0-2	PSK12	✓	✓	<table border="1"> <tr><td>1</td><td>3</td><td>5</td><td>7</td><td>9</td></tr> <tr><td>U</td><td>V</td><td>W</td><td></td><td></td></tr> <tr><td>L1</td><td>L2</td><td>L3</td><td></td><td></td></tr> <tr><td>2</td><td>4</td><td>6</td><td>8</td><td>10</td></tr> <tr><td>1</td><td>X</td><td>X</td><td>X</td><td></td></tr> <tr><td>0</td><td></td><td></td><td></td><td></td></tr> <tr><td>2</td><td>X</td><td></td><td>X</td><td>X</td></tr> </table>	1	3	5	7	9	U	V	W			L1	L2	L3			2	4	6	8	10	1	X	X	X		0					2	X		X	X
1	3	5	7	9																																						
U	V	W																																								
L1	L2	L3																																								
2	4	6	8	10																																						
1	X	X	X																																							
0																																										
2	X		X	X																																						
PSA016MS334S	3 Phase	16	1-0-2	PSK12	✓	✓																																				
PSA020MS334S	3 Phase	20	1-0-2	PSK12	✓	✓																																				
PSA025MS334S	3 Phase	25	1-0-2	PSK12	✓	✓																																				
PSA032MS334S	3 Phase	32	1-0-2	PSK22																																						
PSA040MS334S	3 Phase	40	1-0-2	PSK22																																						
PSA050MS334S	3 Phase	50	1-0-2	PSK32																																						
PSA063MS334S	3 Phase	63	1-0-2	PSK32																																						
PSA080MS334S	3 Phase	80	1-0-2	-																																						
PSA120MS334S	3 Phase	120	1-0-2	-																																						

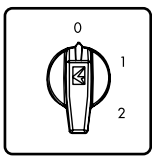

PSA016CD332S

### 3 Phase Double Cycle Cam Switches (0-1-2)

Code	Steps	Rated Thermal Current (A)	Enclosure	Key Operated	Quick Installation	Scheme																																																								
PSA010CD332S	3 Phase	10	PSK12	✓	✓	<table border="1"> <tr><td>1</td><td>3</td><td>5</td><td>7</td><td>9</td><td>11</td><td>13</td><td>15</td></tr> <tr><td>X</td><td>U</td><td>L2</td><td>W</td><td>Z</td><td></td><td></td><td></td></tr> <tr><td>L1</td><td>Y</td><td>V</td><td>L3</td><td></td><td></td><td></td><td></td></tr> <tr><td>2</td><td>4</td><td>6</td><td>8</td><td>10</td><td>12</td><td>14</td><td>16</td></tr> <tr><td>0</td><td></td><td></td><td></td><td></td><td></td><td></td><td></td></tr> <tr><td>1</td><td>X</td><td></td><td>X</td><td>X</td><td>X</td><td></td><td></td></tr> <tr><td>2</td><td>X</td><td>X</td><td>X</td><td>X</td><td>X</td><td>X</td><td></td></tr> </table>	1	3	5	7	9	11	13	15	X	U	L2	W	Z				L1	Y	V	L3					2	4	6	8	10	12	14	16	0								1	X		X	X	X			2	X	X	X	X	X	X	
1	3	5	7	9	11		13	15																																																						
X	U	L2	W	Z																																																										
L1	Y	V	L3																																																											
2	4	6	8	10	12		14	16																																																						
0																																																														
1	X		X	X	X																																																									
2	X	X	X	X	X		X																																																							
PSA016CD332S	3 Phase	16	PSK12	✓	✓																																																									
PSA020CD332S	3 Phase	20	PSK12	✓	✓																																																									
PSA025CD332S	3 Phase	25	PSK12	✓	✓																																																									
PSA032CD332S	3 Phase	32	PSK22																																																											
PSA040CD332S	3 Phase	40	PSK22																																																											
PSA050CD332S	3 Phase	50	PSK32																																																											
PSA063CD332S	3 Phase	63	PSK32																																																											
PSA080CD332S	3 Phase	80	-																																																											
PSA120CD332S	3 Phase	120	-																																																											

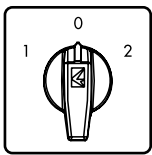

PSA016CD334S

### 3 Phase Double Cycle Cam Switches (1-0-2)

Code	Steps	Rated Thermal Current (A)	Enclosure	Key Operated	Quick Installation	Scheme																																																								
PSA010CD334S	3 Phase	10	PSK12	✓	✓	<table border="1"> <tr><td>1</td><td>3</td><td>5</td><td>7</td><td>9</td><td>11</td><td>13</td><td>15</td></tr> <tr><td>X</td><td>U</td><td>L2</td><td>W</td><td>Z</td><td></td><td></td><td></td></tr> <tr><td>L1</td><td>Y</td><td>V</td><td>L3</td><td></td><td></td><td></td><td></td></tr> <tr><td>2</td><td>4</td><td>6</td><td>8</td><td>10</td><td>12</td><td>14</td><td>16</td></tr> <tr><td>1</td><td>X</td><td></td><td>X</td><td>X</td><td>X</td><td></td><td></td></tr> <tr><td>0</td><td></td><td></td><td></td><td></td><td></td><td></td><td></td></tr> <tr><td>2</td><td>X</td><td>X</td><td>X</td><td>X</td><td>X</td><td>X</td><td></td></tr> </table>	1	3	5	7	9	11	13	15	X	U	L2	W	Z				L1	Y	V	L3					2	4	6	8	10	12	14	16	1	X		X	X	X			0								2	X	X	X	X	X	X	
1	3	5	7	9	11		13	15																																																						
X	U	L2	W	Z																																																										
L1	Y	V	L3																																																											
2	4	6	8	10	12		14	16																																																						
1	X		X	X	X																																																									
0																																																														
2	X	X	X	X	X		X																																																							
PSA016CD334S	3 Phase	16	PSK12	✓	✓																																																									
PSA020CD334S	3 Phase	20	PSK12	✓	✓																																																									
PSA025CD334S	3 Phase	25	PSK12	✓	✓																																																									
PSA032CD334S	3 Phase	32	PSK22																																																											
PSA040CD334S	3 Phase	40	PSK22																																																											
PSA050CD334S	3 Phase	50	PSK32																																																											
PSA063CD334S	3 Phase	63	PSK32																																																											
PSA080CD334S	3 Phase	80	-																																																											
PSA120CD334S	3 Phase	120	-																																																											

\* Can be supplied with Red-Yellow head w/o extra charge, in this case please replace "S" at the end with "E".

\*\* 10-25A Cam Switches can be supplied with big frame (64 x 64) with extra charge, In this case please replace the "S" at the end with "B"

\*\*\* Products are in the key operated columns are suitable for Quick Installation key head with extra charge. In this case, replace "S" letter at the end of the code with "AQ".

\*\*\*\* Please replace "S" letter at the end of the code with "Q" for Quick Installation model (with extra charge)

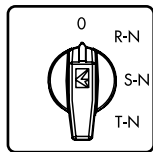

PSA0200K421S

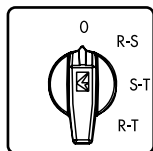

PSA0200K422S

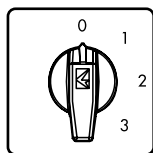

PSA0200K426S

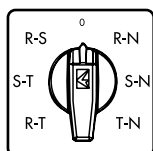

PSA0200K723S

## Measuring Cam Switches - 45°

Code	Type	Rated Thermal Current (A)	Position	Enclosure	Key Operated	Quick Installation	Scheme
PSA0100K421S	4	10	Voltmeter	PSK11	✓	✓	
PSA0160K421S	4	16	Voltmeter	PSK11	✓	✓	
PSA0200K421S	4	20	Voltmeter	PSK11	✓	✓	
PSA0100K422S	4	10	Phase - Phase Voltmeter	PSK11	✓	✓	
PSA0160K422S	4	16	Phase - Phase Voltmeter	PSK11	✓	✓	
PSA0200K422S	4	20	Phase - Phase Voltmeter	PSK11	✓	✓	
PSA0100K426S	4	10	Amperemeter	PSK12	✓	✓	
PSA0160K426S	4	16	Amperemeter	PSK12	✓	✓	
PSA0200K426S	4	20	Amperemeter	PSK12	✓	✓	
PSA0100K723S	7	10	Voltmeter	PSK12	✓	✓	
PSA0160K723S	7	16	Voltmeter	PSK12	✓	✓	
PSA0200K723S	7	20	Voltmeter	PSK12	✓	✓	

\* Please replace "S" letter at the end of the code with "Q" for Quick Installation model (with extra charge)



PSR1



PSR2

## Accessories

Code	Type	Features	Material
PSR1	Rail Mounting Interface	Between 10 - 40 A	Plastic
PSR2	Rail Mounting Interface	Between 50 - 63 A	Plastic



PSK11



PSK12



PSK21



PSK22

## Cam Switch Boxes

Code	Material	Features
PSK11	Plastic	IP54
PSK12	Plastic	IP54
PSK21	Plastic	IP54
PSK22	Plastic	IP54
PSK31	Plastic	IP54
PSK32	Plastic	IP54
PSK11E	Plastic	IP65
PSK12E	Plastic	IP65
PSK21E	Plastic	IP65
PSK22E	Plastic	IP65
PSK31E	Plastic	IP65
PSK32E	Plastic	IP65



PSK31



PSK32



PSA020AK131AQ



PSA010KD134Q



PSA020AK131K



# Industrial Plugs & Sockets



EB004CF00



EB004CP00



EBP04FE41



EBP04FU30



EBP05FU30



EBP05PU30



EBP05PU36



EBP05PE41



EBA05TK



EBM04FE46



EBM04FU10



EBM04FU30



EBM04PE46



EBM04PM46

## Plastic Series

### 4 Poles, 10 A (PG 11)

Code	Type	Entry	Handle	Box/Pcs
EB004CF00	Male Insert			100
EB004CP00	Female Insert			100
EBP04FE41	Sloped Hood with Male Insert	Bottom	✓	50
EBP04FU30	Hood with Male Insert	Top		50
EBP04GE41	Hood for Bulkhead Mounting	Bottom	✓	50
EBP04GM41	Hood for Bulkhead Mounting	Bottom	✓	50
EBP04GU30	Hood	Top		50
EBP04PE41	Sloped Hood with Male Insert	Bottom	✓	50
EBP04PM41	Bulkhead Mounting Male Insert	Bottom	✓	50
EBP04PU30	Hood with Female Insert	Top		50
EBP04PU31	Hood with Female Insert	Top	✓	50

### 5 Poles, 10 A (PG 11)

Code	Type	Entry	Handle	Box/Pcs
EB005CF00	Male Insert			100
EB005CP00	Female Insert			100
EBP05GU30*	Hood	Top		50
EBP05GM41*	Hood for bulkhead mounting	Bottom	✓	50
EBP05GE41*	Hood for bulkhead mounting	Bottom	✓	50
EBP05FU30*	Hood with male insert	Top		50
EBP05PU30*	Hood with female insert	Top		50
EBP05PM41*	Bulkhead mounting, female insert	Bottom	✓	50
EBP05FE41*	Sloped hood with male insert	Bottom	✓	50
EBP05PE41*	Sloped hood with female insert	Bottom	✓	50
EBP05PU31*	Hood with female insert	Top	✓	50
EBA05TK	Cap			50

Product is Grey colour. Please add H to end of the code in order to change the colour to Black.  
For Metal Handle, replace 1 at the end with 6.

## Metal Series

### 4 Poles, 10 A (PG 11)

Code	Type	Entry	Handle	Box/Pcs
EB004CF00	Male Insert			100
EB004CP00	Female Insert			100
EBM04FE46	Sloped Hood with Male Insert	Bottom	✓	50
EBM04FU10	Hood with Male Insert	Side		50
EBM04FU30	Hood with Male Insert	Top		50
EBM04PE46	Sloped Hood with Male Insert	Bottom	✓	50
EBM04PM46	Bulkhead Mounting Female Insert	Bottom	✓	50
EBM04PU10	Hood with Female Insert	Side		50
EBM04PU30	Hood with Female Insert	Top		50
EBM04PU36	Hood with Female Insert	Top	✓	50



EBM04PU10



EBM04PU30



EBM04PU36

NOTE: IP65 Protection Level in combination with appropriate cable gland.



## Metal Series

### 5 Poles, 10 A (PG 11)



Code	Type	Entry	Handle	Box/Pcs
EB005CF00	Male Insert			100
EB005CP00	Female Insert			100
EBM05GU30	Hood	Top		50
EBM05GU36	Hood	Top	✓	50
EBM05GM46	Hood for bulkhead mounting	Bottom	✓	50
EBM05GE46	Sloped hood	Bottom	✓	50
EBM05FU10	Hood with male insert	Top		50
EBM05FU30	Hood with male insert	Side		50
EBM05PU30	Hood with female insert	Top		50
EBM05PU36	Hood with female insert	Top	✓	50
EBM05PM46	Bulkhead mounting, Housing with female insert	Bottom	✓	50
EBM05FE46	Sloped hood with male insert	Bottom	✓	50
EBM05PE46	Sloped hood with female insert	Bottom	✓	50
EBM05PU10	Hood with female insert	Side		50
EBM05PE56	Sloped hood with female insert	Bottom+Side	✓	50
EBA05TK	Cap			50

For Plastic handle models, replace "1" instead of "6".

### 6 Poles, 16 A (PG 16)



Code	Type	Entry	Handle	Box/Pcs
EB006CF00	Male Insert			50
EB006CP00	Female Insert			50
EBM06GU10	Hood	Side		20
EBM06GU30	Hood	Top		20
EBM06GU32	Hood	Top	✓	15
EBM06GM42	Hood for bulkhead mounting	Bottom	✓	20
EBM06FU10	Hood with male insert	Side		20
EBM06FU30	Hood with male insert	Top		20
EBM06PU10	Hood with female insert	Side		20
EBM06PU30	Hood with female insert	Top		20
EBM06PU32	Hood with female insert	Top	✓	20
EBM06FM42	Bulkhead mounting, Housing with Male Insert	Bottom	✓	20
EBM06PM42	Bulkhead mounting, Housing with Female Insert	Bottom	✓	20
EBM06FD12	Surface mounting, Housing with Male Insert	Side	✓	15
EBM06PD12	Surface mounting, Housing with Female Insert	Side	✓	15
EBA06TK	Cap			50

\* For Metal Handle, replace "2" at the end with "6"

### 10 Poles, 16 A (PG 16)



Code	Type	Option	Entry	Handle	Box/Pcs
EB010CF00	Male Insert				50
EB010CP00	Female Insert				50
EBM10GU10	Hood		Side		15
EBM10GU30	Hood	**	Top		15
EBM10GU34*	Hood		Top	✓	10
EBM10GM44*	Hood for bulkhead mounting		Bottom	✓	20
EBM10GD14*	Surface Mounting Head		Side	✓	10
EBM10GD24*	Surface Mounting Head		Both Side	✓	10
EBM10FU10	Hood with male insert	**	Side		15
EBM10FU30	Hood with male insert		Top		15
EBM10PU10	Hood with female insert	**	Side		15
EBM10PU14	Hood with female insert		Side	✓	10
EBM10PU30	Hood with female insert		Top		15
EBM10PU34*	Hood with female insert		Top	✓	10
EBM10FM44*	Bulkhead Mounting, Housing with Male Insert		Bottom	✓	20
EBM10PM44*	Bulkhead Mounting, Housing with Female Insert		Bottom	✓	20
EBM10FD14*	Surface mounting, Housing with Male Insert		Side	✓	10
EBM10FD24*	Surface mounting, Housing with Male Insert		Both Side	✓	10
EBM10PD14*	Surface mounting, Housing with Female Insert		Side	✓	10
EBM10PD24*	Surface mounting, Housing with Female Insert	**	Both Side	✓	10
EBM10PD27	Surface mounting, Housing with female insert		Both Side	✓	10
EBM10TABAN	Base				10
EBA10TK	Cap				50

\* For Metal Handle, replace "4" at the end with "7". Standard PG16, please add PG21 to the end of the code in order to order PG21 hole.

IP65 Protection Level in combination with appropriate cable gland.





EBM16CP00



EBM16CF00



EBM16FU10



EBM16FM44



EBM16PD14



EBM16FD24



EBA24TK



EBA16TK



EBM24CP00



EBM24CF00



EBM24FU10



EBM24PU10



EBM24FD24



EBM24PM44



EBM32FU10



EBM32PU10



EBM32PM44



EBM32FM44



EBA48TK



EBA32TK

## 16 Poles, 16 A (PG 21)

Code	Type	Entry	Handle	Box/Pcs
EB016CF00	Male Insert			50
EB016CP00	Female Insert			50
EBM16GU10	Hood	Side		10
EBM16GU30	Hood	Top		10
EBM16GU34*	Hood	Top	✓	8
EBM16GM44*	Hood for bulkhead mounting	Bottom	✓	15
EBM16GD14*	Surface mounting hood	Side	✓	8
EBM16GD24*	Surface mounting hood	Both Side	✓	8
EBM16FU10	Hood with male insert	Side		10
EBM16FU30	Hood with male insert	Top		10
EBM16PU10	Hood with female insert	Side		10
EBM16PU14	Hood with female insert	Top	✓	10
EBM16PU30	Hood with female insert	Top		10
EBM16PU34*	Bulkhead Mounting, Housing with Male Insert	Bottom	✓	8
EBM16FM44*	Bulkhead Mounting, Housing with Female Insert	Bottom	✓	15
EBM16PM44*	Surface mounting, Housing with Male Insert	Side	✓	15
EBM16FD14*	Surface mounting, Housing with Male Insert	Both Side	✓	8
EBM16FD24*	Surface mounting, Housing with Female Insert	Side	✓	8
EBM16PD14*	Surface mounting, Housing with Female Insert	Both Side	✓	8
EBM16PD24*	Surface mounting, Housing with female insert	Bottom	✓	8
EBM16PD27	Surface mounting, Housing with female insert	Both Side	✓	8
EBA16TK	Cap			50

\* For Metal Handle, replace "4" at the end with "7".

## 24 Poles, 16 A (PG 21)

Code	Type	Entry	Handle	Box/Pcs
EB024CF00	Male Insert			30
EB024CP00	Female Insert			30
EBM24GU10	Hood	Side		10
EBM24GU30	Hood	Top		10
EBM24GU34*	Hood	Top	✓	8
EBM24GM44*	Hood for bulkhead mounting	Bottom	✓	15
EBM24GD14*	Surface mounting hood	Side	✓	8
EBM24GD24*	Surface mounting hood	Both Side	✓	8
EBM24FU10	Hood with male insert	Side		10
EBM24FU30	Hood with male insert	Top		10
EBM24PU10	Hood with female insert	Side		10
EBM24PU14	Hood with female insert	Side	✓	10
EBM24PU30	Hood with female insert	Top		10
EBM24PU34*	Hood with female insert	Top	✓	8
EBM24FM44*	Bulkhead Mounting, Housing with Male Insert	Bottom	✓	15
EBM24PM44*	Bulkhead Mounting, Housing with Female Insert	Bottom	✓	15
EBM24PM47	Bulkhead mounting, Housing with female insert	Bottom	✓	15
EBM24FD14*	Surface mounting, Housing with Male Insert	Side	✓	8
EBM24FD24*	Surface mounting, Housing with Male Insert	Both Side	✓	8
EBM24PD14*	Surface mounting, Housing with Female Insert	Side	✓	8
EBM24PD24*	Surface mounting, Housing with Female Insert	Both Side	✓	8
EBA24TK	Cap			50

\* For Metal Handle, replace "4" at the end with "7".

## 32 Poles, 16 A (PG 21)

Code	Type	Option	Entry	Handle	Box/Pcs
EB016CF00	Male Insert (1-16)				50
EB016CP00	Female Insert (1-16)				50
EB032CF00	Male Insert (17-32)				30
EB032CP00	Female Insert (17-32)				30
EBM32GU10	Hood	**	Side		6
EBM32GU30	Hood	**	Top		6
EBM32GM44*	Hood for bulkhead mounting		Bottom	✓	10
EBM32FU10	Hood with male insert	**	Side		6
EBM32FU30	Hood with male insert	**	Top		6
EBM32PU10	Hood with female insert	**	Side		6
EBM32PU30	Hood with female insert	**	Top		6
EBM32FM44*	Bulkhead Mounting, Housing with Male Insert		Bottom	✓	10
EBM32PM44*	Bulkhead Mounting, Housing with Female Insert		Bottom	✓	10
EBM32PU14	Hood with female insert		Side	✓	6
EBM32PU34	Hood with female insert		Top	✓	6
EBM32TABAN	Base				6
EBA32TK	Cap				40

\* For Metal Handle, replace "4" at the end with "8". Standard PG21, please add PG29 to the end of the code in order to order PG29 hole.

IP65 Protection Level in combination with appropriate cable gland.



EBM48PU10



EBM48FU10



EBM48FU30



EBM48PM44



EB0606CP00



EB0606CF00



EBM606FU10



EBM606PD14



EBA16TK



EBM612PU10



EBM612PM44



EBA32TK



EB0806CF00



EB0806CP00



EBM806FU10



EBM806PD14



EBA16TK

## 48 Poles, 16 A (PG 29)

Code	Type	Entry	Handle	Box/Pcs
EB024CF00	Male Insert (1-24)			30
EB024CP00	Female Insert (1-24)			30
EB048CF00	Male Insert (25-48)			30
EB048CP00	Female Insert (25-48)			30
EBM48GU10	Hood	Side		4
EBM48GU30	Hood	Top		4
EBM48GM44*	Hood for bulkhead mounting	Bottom	✓	8
EBM48FU10	Hood with male insert	Side		4
EBM48FU30	Hood with male insert	Top		4
EBM48PU10	Hood with female insert	Side		4
EBM48PU30	Hood with female insert	Top		4
EBM48FM44*	Bulkhead Mounting, Housing with Male Insert	Bottom	✓	8
EBM48PM44*	Bulkhead Mounting, Housing with Female Insert	Bottom	✓	8
EBM48PU14	Hood with female insert	Side	✓	4
EBM48PU34	Hood with female insert	Top	✓	4
EBM48TABAN	Base			4
EBA48TK	Cap			40

\* For Metal Handle, replace "4" at the end with "8".

## 6 Poles, 35 A (PG 21)

Code	Type	Entry	Handle	Box/Pcs
EB0606CF00	Male Insert			50
EB0606CP00	Female Insert			50
EBM606FU10	Hood with male insert	Side		10
EBM606FU30	Hood with male insert	Top		10
EBM606PU10	Hood with female insert	Side		50
EBM606PU30	Hood with female insert	Top		10
EBM606PU34*	Hood with female insert	Top	✓	8
EBM606FM44*	Bulkhead Mounting, Housing with Male Insert	Bottom	✓	15
EBM606PM44*	Bulkhead Mounting, Housing with Female Insert	Bottom	✓	15
EBM606FD14*	Surface mounting, Housing with Male Insert	Side	✓	8
EBM606FD24*	Surface mounting, Housing with Male Insert	Both Side	✓	8
EBM606PD14*	Surface mounting, Housing with Female Insert	Side	✓	8
EBM606PD24*	Surface mounting, Housing with Female Insert	Both Side	✓	8
EBA16TK	Cap			50

\* For Metal Handle, replace "4" at the end with "7".

## 12 Poles, 35 A (PG 21)

Code	Type	Entry	Handle	Box/Pcs
EB0606CF00	Male Insert (1-6)			50
EB0606CP00	Female Insert (1-6)			50
EB0612CF00	Male Insert (7-12)			50
EB0612CP00	Female Insert (7-12)			50
EBM612FU10	Hood with male insert	Side		6
EBM612FU30	Hood with male insert	Top		6
EBM612PU10	Hood with female insert	Side		6
EBM612PU30	Hood with female insert	Top		6
EBM612FM44*	Bulkhead Mounting, Housing with Male Insert	Bottom	✓	10
EBM612PM44*	Bulkhead Mounting, Housing with Female Insert	Bottom	✓	10
EBA32TK	Cap			40

\* For Metal Handle, replace "4" at the end with "8".

## 6 Poles (4 x 80A + 2 x 16A) (PG21)

Code	Type	Entry	Handle	Box/Pcs
EB0806CF00	Male Insert			50
EB0806CP00	Female Insert			40
EBM806FU10	Hood with male insert	Side		10
EBM806FU30	Hood with male insert	Top		10
EBM806FM44*	Bulkhead mounting, housing with male insert with 4 roller handle	Bottom	✓	15
EBM806FD14*	Surface mounting, housing with male insert	Side	✓	8
EBM806FD24*	Surface mounting, housing with male insert	Both Side	✓	8
EBM806PM44*	Bulkhead mounting, housing with female insert with 4 roller handle	Bottom	✓	15
EBM806PU10	Hood with female insert	Side		10
EBM806PU30	Hood with female insert	Top		10
EBM806PD14*	Surface mounting, housing with male insert	Side	✓	8
EBM806PD24*	Surface mounting, housing with female insert	Both Side	✓	8
EBA16TK	Cap			50

\* For Metal Handle, replace "4" at the end with "7".

IP65 Protection Level in combination with appropriate cable gland.



EBM812FU30



EBM812PM44



EBA32TK

## 12 Poles, 2 x (4 x 80A + 2 x 16A) (PG 21)

Code	Type	Entry	Handle	Box/Pcs
EB0806CF00	Male Insert (1-6)			50
EB0806CP00	Female Insert (1-6)			50
EB0812CF00	Male Insert (7-12)			50
EB0812CP00	Female Insert (7-12)			50
EBM812FU10	Hood with male insert	Side		6
EBM812FU30	Hood with male insert	Top		6
EBM812FM44 *	Bulkhead Mounting, Housing with Male Insert with 4 Roller Handle	Bottom	✓	8
EBM812PM44*	Bulkhead Mounting, Housing with Female Insert with 4 Roller Handle	Bottom	✓	10
EBM812PU10	Hood with male insert	Side		6
EBM812PU30	Hood with female insert	Top		6
EBA32TK	Cap			40

\* For Metal Handle, replace "4" at the end with "7".

IP65 Protection Level in combination with appropriate cable gland.



EBMKE



EBMKD

## Accessories

Code	Features	Box/Pcs
EBMKD	Marking Pin - Female	10
EBMKE	Marking Pin - Male	10



EPREU1M



EPRUS1H



EPREU2G



EPRFR2K



EPREU2GL

## Panel Type Sockets

Code	Features	Colour	Box/Pcs
EPREU1M	European Schuko Type 1		100
EPRUS1H	American, Type1		100
EPREU2G	Rail Types		10
EPREU2GL	Rail Types, with LED		10
EPRFR2K	Panel Socket, UPS Socket (French Type)		100
EPRFR2G	Rail Type, UPS Socket (French Type)		10

NEW

## Rubber Type Plugs & Sockets

Code	Type	Features	Box/Pcs
EKS116F	Plug	1 x 16 A	40
EKS116P	Socket	1 x 16 A	30
EKS116PG1	Wall Socket	1 x 16 A	20
EKS116PG3	Group Socket - 3 Way	3x (1 x 16 A)	6
EKS325F	Plug	3 x 25 A	30
EKS325P	Socket	3 x 25 A	20
EKS325PGP30	Group Socket - 3 Way	3 x (3 x 25) A	4
EKS325PG21	Group Socket - 3 Way	2 x (3x25) A + 1 (1x16) A	4
EKS325PG12	Group Socket - 3 Way	1 x (3x25) A + 2 (1x16) A	4



EKS116PG3



EKS325F



EKS116F



EKS116PG1





IK53L024XM03



IT120Y024



IT120R024



IT120R024Z



IF5T024ZM05



IF5Y024XM05



IF6P024ZM05



# Signalling Devices

## IK Series

Light Towers can be purchased as complete or modular. Mounting system is easy with plug and turn system without any mounting equipment.

### COMPLETE LIGHT TOWER Dia 50 mm ( with 100 mm Aluminium connection, body and Lamps)

LED	LED Flasher	Single Level Buzzer
IK51 L * X M 03	IK51 F * X M 03	IK50X*ZM03
IK52 L * X M 03	IK52 F * X M 03	
IK53 L * X M 03	IK53 F * X M 03	
IK54 L * X M 03	IK54 F * X M 03	
IK55 L * X M 03	IK55 F * X M 03	



### COMPLETE LIGHT TOWER Dia 70 mm (100 mm Plastic connection, body and Lamps)

LED	LED Flasher	Single Level Buzzer
IK71 L * X M 01	IK71 F * X M 01	IK70X*ZM01
IK72 L * X M 01	IK72 F * X M 01	
IK73 L * X M 01	IK73 F * X M 01	
IK74 L * X M 01	IK74 F * X M 01	
IK75 L * X M 01	IK75 F * X M 01	



\*Shows the voltage of the lamp. When it is written "024", it means that it is 24V AC/DC, when it is written "220", it means that it is 220VACType

\*\*\* Shows the connection type. Please check the connection Module Part for detail. "X" is replaced with "Z" for Buzzer with extra charge.

For IP65 please add E letter to the end of the code. (Excluding buzzer versions)

## MODULES

Each Light Tower consists of below components.

1. Body and Cover
2. Signal Modules (5 Colour)
3. Buzzer module
4. LED, Flashing LED
5. Connection

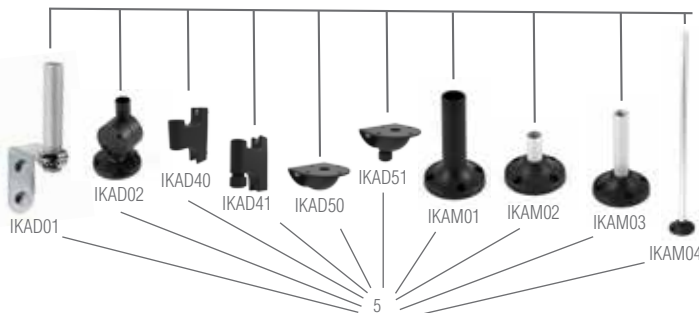
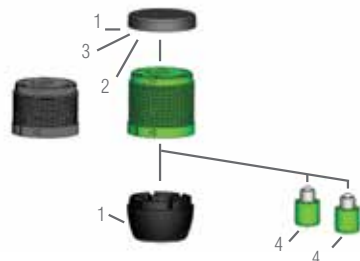

### 1-Body and Cover

IKM 5 Dia 50 mm



### 1-Body and Cover

IKM 7 Dia 70 mm



\* Maximum up to 5 modules can be mounted

### 2- Signal Modules

Heat resistant polycarbonate material

IKM 5 50 mm



### 2- Signal Modules

Heat resistant polycarbonate material

IKM 7 70 mm



### 3- Buzzer Modules

IKM 5Z 024  
50 mm / 90 dB  
IKM 5Z 220  
50 mm / 90 dB



### 3- Buzzer Modules

IKM 7Z 024  
70 mm / 90 dB  
IKM 7Z 220  
70 mm / 90 dB



## LAMPS

4	with LED		with Flashing LED	
24 VDC	IKM L 024		IKM F 024	
	IKM L 024		IKM F 024	
	IKM L 024		IKM F 024	
	IKM L 024		IKM F 024	
	IKM L 024		IKM F 024	
220 VAC	IKM L 220		IKM F 220	
	IKM L 220		IKM F 220	
	IKM L 220		IKM F 220	
	IKM L 220		IKM F 220	
	IKM L 220		IKM F 220	

Note. One lamp should be added for each Signal module.

## 5- Mounting Options

IKA M 01	100 mm Plastic base (Standard for Dia.70 mm, not applicable for Dia 50 )
IKA M 02	20 mm Aluminium base
IKA M 03	100 mm Aluminium base (Standart for Dia 50 mm)
IKA M 04	500 mm Aluminium base
IKA D 01	Wall Connection, 100 mm Aluminium tube
IKA D 02	Adjustable wall elbow
IKAD40	Wall connection with tube - Side Entry
IKAD41	Wall connection with tube - Bottom Entry ( with cable gland )
IKAD50	Wall connection with base - Side Entry
IKAD51	Wall connection with base - Bottom Entry ( with cable gland )
IKA B 10	100mm Aluminium Tube



## IF Series Multi Colour Beacons with Ø 22 mm connection, IP65



### IF Series

- Single body, multi colour
- Ø22 mm Connection
- Flashing and normal LED mode available in same module.
- 90 dB Buzzer



IF5T024ZM05

IF5M220ZM05

IF6P024WM05

IFAB01

IFAB03

IKAM02

IKAD03

Code	Illumination	Features	Nominal Voltage	Box/Pcs
IF5*024XM05	LED	Single Colour	24V AC/DC	1
IF5*024XM05	LED	Single Colour, Rotational	24V AC/DC	1
IF5*024ZM05	LED	Single Colour, With Buzzer	24V AC/DC	1
IF5*024ZRM05	LED	Single Colour, With Buzzer, Rotational	24V AC/DC	1
IF5*220XM05	LED	Single Colour	220V AC	1
IF5*220XRM05	LED	Single Colour, Rotational	220V AC	1
IF5*220ZM05	LED	Single Colour, With Buzzer	220V AC	1
IF5*220ZRM05	LED	Single Colour, With Buzzer, Rotational	220V AC	1
IF5M012XM05	LED	5 Colours	12V AC/DC	1
IF5M012ZM05	LED	5 Colours, With Buzzer	12V AC/DC	1
IF5M024XM05	LED	5 Colours	24V AC/DC	1
IF5M024ZM05	LED	5 Colours, With Buzzer	24V AC/DC	1
IF5M110XM05	LED	5 Colours	110V AC	1
IF5M110ZM05	LED	5 Colours, With Buzzer	110V AC	1
IF5M220XM05	LED	5 Colours	220V AC	1
IF5M220ZM05	LED	5 Colours, With Buzzer	220V AC	1
IF5P024XM05	LED	5 Colours, PLC Harmonized	24V DC	1
IF5P024ZM05	LED	5 Colours, PLC Harmonized, With Buzzer	24V DC	1
IF5T024XM05	LED	3 Layers in Single Body, 3 Colours, PLC Harmonized	24V DC	1
IF5T024ZM05	LED	3 Layers in Single Body, 3 Colours, PLC Harmonized+with Buzzer	24V DC	1
IF6P024WM05	LED	PLC Harmonized, 5 Colours, with Self-Adjusted Buzzer**	24V DC	1
IFAB01		Pipe Adaptation Part, Silver		1
IFAB03		Pipe Adaptation Part, Black		1
IKAD03		Adjustable, wall support, with tube		1
IKAM02		20 mm aluminium with base (usable with IFAB01)		1

Note: For base options, please choose metal bases from page 63. Should be used with IFAB01 or IFAB03.

\*Single Colour

\*\* If the environment noise is less than 80dB the beacon will sound at 90dB. If the environment noise is greater than 80dB the beacon automatically changes the sound to 105dB.

R: Red, G: Green, Y: Yellow, B: Blue, W: White

## IF Series Multi Colour Beacons with $\varnothing 22$ mm Connection, IP65

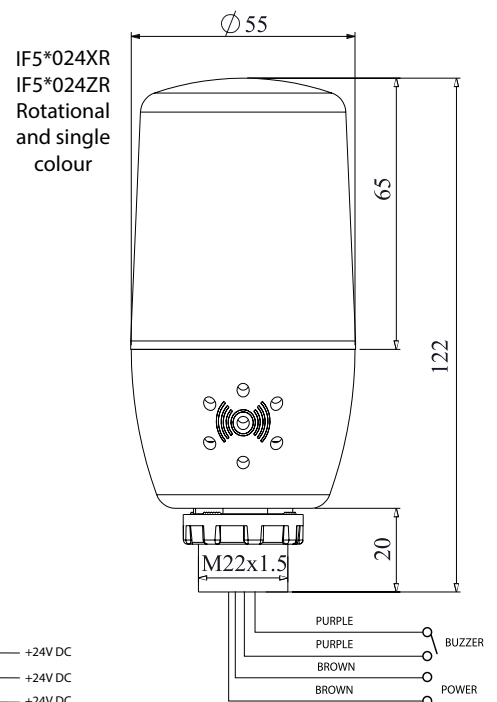
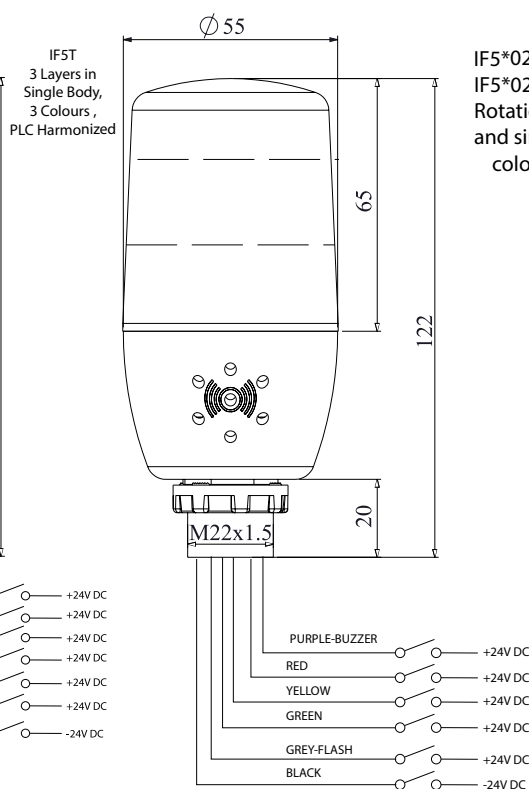
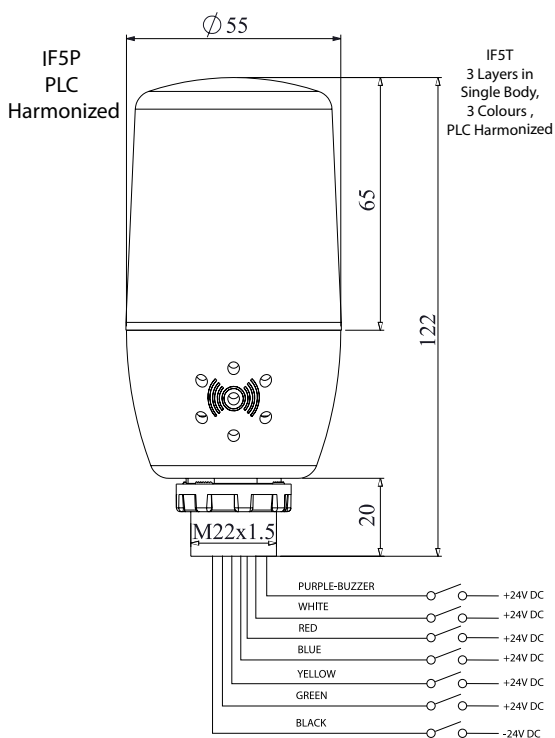
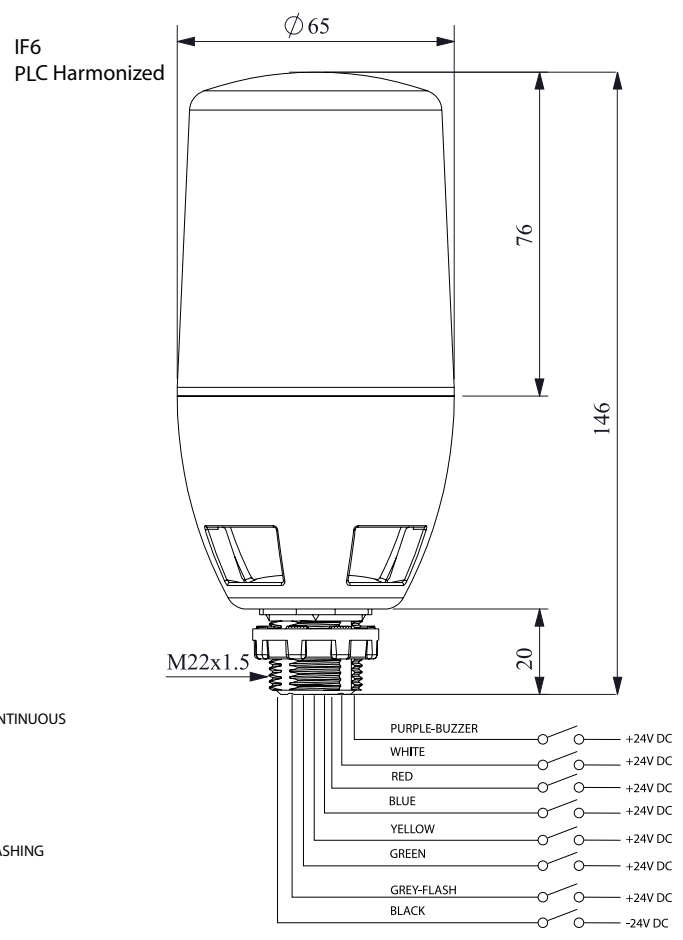
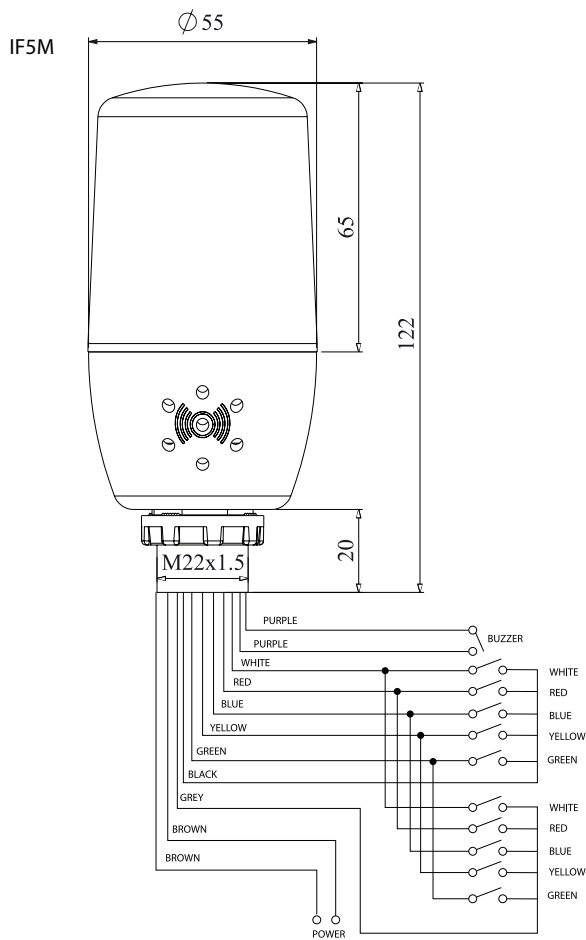

## IT Series, IP67



IT120R024

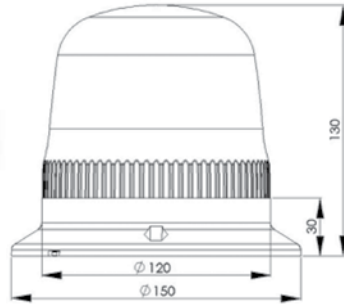

IT120R024Z

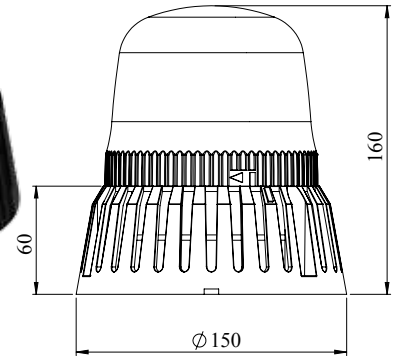

MODE name	1	2	3	4
Rotation 100 RPM	↑	↑	↑	X
One Flash	↑	↑	↓	X
Three Flash	↑	↓	↑	X
Six Flash	↑	↓	↓	X
Blink	↓	↑	↑	X
Continuous Flash*	↓	↑	↓	X
Right-Left Flash	↓	↓	↑	X
Rotation 160 RPM	↓	↓	↓	X

X = Not used

↑ = Up

↓ = Down

\* In 220V AC models, this mode is off.

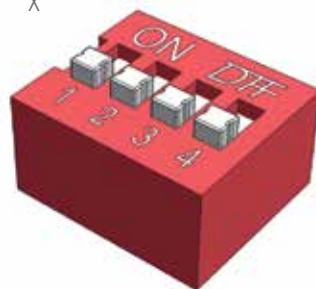

### Beacon

#### General Specification;

- Fireproof plastic body
- Polycarbonate lens
- Base and wall-mount
- Unaffected by water, dust, heat and UV.
- Wear-free due to the absence of moving components
- Long life
- 8 Different signal effects
- IP 67 rating (IP68 rating in Buzzer type)

#### Technical Specification;

- Operating Voltage: 12-24V AC/DC, 48-110- 220V AC,
- Current consumption: 3,4W (at 24 V DC by rotating mode)
- Operating temperature: -20 / +50 C°
- Storage temperature: -20 / +70 C°
- 105dB Buzzer

Code	Light	Colour	Features	Voltage	Box/Pcs
IT120R024	LED	R		12-24V AC/DC	1
IT120R024Z	LED	R	With Buzzer	12-24V AC/DC	1
IT120R048	LED	R		48V AC	1
IT120R220	LED	R		110-220V AC	1
IT120R220Z	LED	R	With Buzzer	110-220V AC	1
IT120Y024	LED	Y		12-24V AC/DC	1
IT120Y024Z	LED	Y	With Buzzer	12-24V AC/DC	1
IT120Y048	LED	Y		48V AC	1
IT120Y220	LED	Y		110-220V AC	1
IT120Y220Z	LED	Y	With Buzzer	110-220V AC	1
IT120G024	LED	G		12-24V AC/DC	1
IT120G024Z	LED	G	With Buzzer	12-24V AC/DC	1
IT120G048	LED	G		48V AC	1
IT120G220	LED	G		110-220V AC	1
IT120G220Z	LED	G	With Buzzer	110-220V AC	1



MKS1-KES



TSP-0.32



MKS1TM-0.40

# Motor Protection Circuit Breakers



MKS1TM-0.40

## Thermic & Magnetic Protection

Code	Current Calibration Interval (A)	Fuse Selection Table (A)				Switching Capacity (kA)				Box/Pcs
		230V	400V	500V	690V	230V	400V	500V	690V	
MKS1TM-0.16	0.10 - 0.16	-	-	-	-	100	100	100	100	1
MKS1TM-0.25	0.16 - 0.25	-	-	-	-	100	100	100	100	1
MKS1TM-0.40	0.25 - 0.40	-	-	-	-	100	100	100	100	1
MKS1TM-0.63	0.40 - 0.63	-	-	-	-	100	100	100	100	1
MKS1TM-1	0.63 - 1.00	-	-	-	-	100	100	100	100	1
MKS1TM-1.6	1.00 - 1.60	-	-	-	-	6	6	3	2,5	1
MKS1TM-2.5	1.60 - 2.50	-	-	25	20	6	6	3	2,5	1
MKS1TM-4	2.50 - 4.00	-	-	35	25	6	6	3	2,5	1
MKS1TM-6.3	4.00 - 6.30	-	-	50	35	6	6	2,5	2	1
MKS1TM-10	6.30 - 10.0	-	80	50	35	6	6	2,5	2	1
MKS1TM-16	10.0 - 16.0	80	80	63	35	6	6	2,5	2	1
MKS1TM-20	16.0 - 20.0	80	80	63	50	6	6	2,5	2	1
MKS1TM-25	20.0 - 25.0	80	80	63	50	6	6	2,5	2	1

## Thermic & Magnetic Protection Boxes



MKS1-K

### MKS-Box Type

Code	Current Calibration Interval (A)	Mounting	Button Case	Box/Pcs
MKS1TMK-0.16	0.10 - 0.16	Surface	IP65	1
MKS1TMK-0.25	0.16 - 0.25	Surface	IP65	1
MKS1TMK-0.40	0.25 - 0.40	Surface	IP65	1
MKS1TMK-0.63	0.40 - 0.63	Surface	IP65	1
MKS1TMK-1	0.63 - 1.00	Surface	IP65	1
MKS1TMK-1.6	1.00 - 1.60	Surface	IP65	1
MKS1TMK-2.5	1.60 - 2.50	Surface	IP65	1
MKS1TMK-4	2.50 - 4.00	Surface	IP65	1
MKS1TMK-6.3	4.00 - 6.30	Surface	IP65	1
MKS1TMK-10	6.30 - 10.0	Surface	IP65	1
MKS1TMK-16	10.0 - 16.0	Surface	IP65	1
MKS1TMK-20	16.0 - 20.0	Surface	IP65	1
MKS1TMK-25	20.0 - 25.0	Surface	IP65	1



MKS1-KES

### Accessories

Code	Type	Features	Box/Pcs
MKS1-K	MKS Box	Empty	1
MKS1-KE	MKS Box	With Emergency Stop Button	1
MKS1-KES	MKS Box	With Emergency Stop Button and Signal	1
MKS1-YKD00	Auxiliary Contact	2 NC	4
MKS1-YKD01	Auxiliary Contact	1 NO + 1 NC	4
MKS1-YKD11	Auxiliary Contact	2 NO	4
MKS1-DGR-4	Undervoltage Release	110V	1
MKS1-DGR-5	Undervoltage Release	220V	1
MKS1-DGR-6	Undervoltage Release	400V	1
MKS1-AR-5	Shunt Release	220V	1
MKS1-AR-6	Shunt Release	400V	1



MKS1-YKD00



MKS1-DGR-5



## Thermic Protection



TSP-0.32

### TSP-with Box

Code	Current Calibration Interval (A)	Mounting	Protection	Box/Pcs
TSP-0.32	0.18 - 0.32	Surface	IP65	1
TSP-0.55	0.30 - 0.55	Surface	IP65	1
TSP-0.70	0.40 - 0.70	Surface	IP65	1
TSP-1.00	0.60 - 1.00	Surface	IP65	1
TSP-1.60	0.90 - 1.60	Surface	IP65	1
TSP-2.50	1.50 - 2.50	Surface	IP65	1
TSP-3.50	2.40 - 3.50	Surface	IP65	1
TSP-5.50	3.20 - 5.50	Surface	IP65	1
TSP-8.50	5.00 - 8.50	Surface	IP65	1
TSP-13.0	8.00 - 13.00	Surface	IP65	1
TSP-16.0	11.00 - 16.00	Surface	IP65	1



TSG-0.32

### TSG-Flush Type

Code	Current Calibration Interval (A)	Mounting	Protection	Box/Pcs
TSG-0.32	0.18 - 0.32	Flush	IP65	1
TSG-0.55	0.30 - 0.55	Flush	IP65	1
TSG-0.70	0.40 - 0.70	Flush	IP65	1
TSG-1.00	0.60 - 1.00	Flush	IP65	1
TSG-1.60	0.90 - 1.60	Flush	IP65	1
TSG-2.50	1.50 - 2.50	Flush	IP65	1
TSG-3.50	2.40 - 3.50	Flush	IP65	1
TSG-5.50	3.20 - 5.50	Flush	IP65	1
TSG-8.50	5.00 - 8.50	Flush	IP65	1
TSG-13.0	8.00 - 13.00	Flush	IP65	1
TSG-16.0	11.00 - 16.00	Flush	IP65	1



# Level Control Float Switches



SKF

<b>Cobra</b>		
Code	Poles	Cable Length (m)
SKF-0.5	1	0,50
SKF	1	1,75
SKF-3	1	3
SKF-5	1	5
SKF-10	1	10
SKF-15	1	15
SKF-20	1	20
SKF-35	1	35



SKF1A

<b>Bulb</b>		
Code	Poles	Cable Length (m)
SKF1A-1*	1	1
SKF1A*	1	1,75
SKF1A-3*	1	3
SKF1A-5*	1	5
SKF1A-10*	1	10
SKF1A-15*	1	15
SKF1A-20*	1	20
SKF1A-30*	1	30

\* For Neoprene cable, please add "N" letter to end of the code (Please ask prices)



SK5P

<b>Switch Actuated</b>		
Code	Remote Control	Stainless Float
SK5P	√	



HNY11



HJ12X09UB



HJ11A09UG

# Contactors

## HN Series Contactors



HN0901NU



HN1301NU



HN40NU

Code	Rated Current (A) 380V AC3	Rated Thermal Current (A) Ith	Auxiliary Con- tacts	Power (kW)			Box/Pcs
				220-240V	380-415V	660V	
HN0901N*	9	20	1 NC	2,2	4	4,5	1
HN0910N*	9	20	1 NO	2,2	4	4,5	1
HN1301N*	13	20	1 NC	3,2	6	6,5	1
HN1310N*	13	20	1 NO	3,2	6	6,5	1
HN1701N*	17	30	1 NC	4	7,5	8,5	1
HN1710N*	17	30	1 NO	4	7,5	8,5	1
HN2501N*	25	30	1 NC	6	11	12,5	1
HN2510N*	25	30	1 NO	6	11	12,5	1
HN33N*	33	45		7,5	15	18,5	1
HN40N*	40	45		11	22	30	1



HNMK1



HNYU22



HNYB11

Accessories			
Code	Features	Contact Block	Box/Pcs
HNMK1	9-13 A Mechanical Interlock		1
HNYU04	9-65 A Auxiliary Contact Block	4 NC	1
HNYU40	9-65 A Auxiliary Contact Block	4 NO	1
HNYU13	9-65 A Auxiliary Contact Block	1 NO + 3 NC	1
HNYU31	9-65 A Auxiliary Contact Block	3 NO + 1 NC	1
HNYU22	9-65 A Auxiliary Contact Block	2 NO + 2 NC	1
HNYU20	9-65 A Auxiliary Contact Block	2 NO	1
HNYU02	9-65 A Auxiliary Contact Block	2 NC	1
HNYU11	9-65 A Auxiliary Contact Block	1 NO + 1 NC	1
HNYB11	17-65 A Auxiliary Contact Block	1 NO + 1 NC	5

Contactor Coil		
Code	Features	Box/Pcs
IH13*	HN09-HN13	1
IH25*	HN17-HN40	1



IH13U

Code	Voltage
B	440V / 50 HZ
C	366V / 50 HZ
D	110-115V / 50-60 HZ
F	24V / 50-60 HZ
G	48V / 50HZ
U	220-230V / 50-60 HZ
W	380-400V / 50-60 HZ
X	220-240V / 50 HZ
Z	480-500V / 50 HZ

\* For Voltage selection, please use below codes.



## Thermal Relay



JA25A

Code	Current Calibration Interval (A)	Box/Pcs
JA25A	0.15 - 0.25	1
JA25B	0.22 - 0.33	1
JA25C	0.30 - 0.45	1
JA25D	0.42 - 0.63	1
JA25E	0.60 - 0.90	1
JA25F	0.85 - 1.27	1
JA25G	1.20 - 1.75	1
JA25H	1.70 - 2.60	1
JA25I	2.50 - 3.70	1
JA25L	3.60 - 5.40	1
JA25M	5.30 - 7.50	1
JA25N	7.30 - 10.2	1
JA25O	10.0 - 15.0	1
JA25P	13.5 - 20.0	1
JA25Q	18.0 - 26.0	1

## Direct Starters with Contactor and Thermal Relay



HJ12X09UB

### HJ12- HJ22 with Box

Code	Type	Current Calibration Interval (A)	Contactor Rated Current (A) 380V	Power (kW) 380 - 415V	Box Size
HJ12X09UA	Box with Start and Reset Buttons	0.15 - 0.25	9	0,06	2. Size
HJ12X09UB*	Box with Start and Reset Buttons	0.22 - 0.33	9	0,09	2. Size
HJ12X09UC*	Box with Start and Reset Buttons	0.30 - 0.45	9	0,12	2. Size
HJ12X09UD*	Box with Start and Reset Buttons	0.42 - 0.63	9	0,15	2. Size
HJ12X09UE*	Box with Start and Reset Buttons	0.60 - 0.90	9	0,24	2. Size
HJ12X09UF*	Box with Start and Reset Buttons	0.85 - 1.27	9	0,37	2. Size
HJ12X09UG*	Box with Start and Reset Buttons	1.20 - 1.75	9	0,55	2. Size
HJ12X09UH*	Box with Start and Reset Buttons	1.70 - 2.60	9	1,1	2. Size
HJ12X09UI*	Box with Start and Reset Buttons	2.50 - 3.70	9	1,5	2. Size
HJ12X09UL*	Box with Start and Reset Buttons	3.60 - 5.40	9	2,2	2. Size
HJ12X09UM*	Box with Start and Reset Buttons	5.30 - 7.50	9	3	2. Size
HJ12X13UN*	Box with Start and Reset Buttons	7.30 - 10.2	13	4	2. Size
HJ22X17UO*	Box with Start and Reset Buttons	10.0 - 15.0	17	5,5	4. Size
HJ22X25UP*	Box with Start and Reset Buttons	13.5 - 20.0	25	7,5	4. Size
HJ22X25UQ*	Box with Start and Reset Buttons	18.0 - 26.0	25	11	4. Size

\* If you require Signal included in the box, you can put "S" to end of the code. In that case, S100NK's Signal price will be added.

### HJ11- HJ 21 with Box



HJ11A09UG

Code	Type	Current Calibration Interval (A)	Contactor Rated Current (A) 380V	Power (kW) 380 - 415V	Box Size
HJ11A09UG	with illuminated on-off switch + with reset button + with 10 mm Signal lamp	1.20 - 1.75	9	0.55	1. Size
HJ11A09UH		1.70 - 2.60	9	1.10	1. Size
HJ11A09UI		2.50 - 3.70	9	1.50	1. Size
HJ11A09UL		3.60 - 5.40	9	2.20	1. Size
HJ11A09UM		5.30 - 7.50	9	3.00	1. Size
HJ11A13UN		7.30 - 10.2	13	4.00	1. Size
HJ21A17UO		10.0 - 15.0	17	5,50	3. Size
HJ21A25UP		13.5 - 20.0	25	7,50	3. Size
HJ21A25UQ		18.0 - 26.0	25	11.00	3. Size

### Empty Box

Code	Type	Box/Pcs
HJ11	1. Size	1
HJ12	2. Size	1
HJ21	3. Size	1
HJ22	4. Size	1



RS1P08G1



RE1P08DC024

# Industrial Relays & Sockets



RE1P08DC024

## Industrial Relays

Code	Number of Pins	Coil Voltage	Number of Contacts	Box/Pcs
RE1P08AC012	8 pins	12V AC	2 Changeover Contacts	25
RE1P08AC024	8 pins	24V AC	2 Changeover Contacts	25
RE1P08AC048	8 pins	48V AC	2 Changeover Contacts	25
RE1P08AC110	8 pins	110V AC	2 Changeover Contacts	25
RE1P08AC220	8 pins	230V AC	2 Changeover Contacts	25
RE1P08DC012	8 pins	12V DC	2 Changeover Contacts	25
RE1P08DC024	8 pins	24V DC	2 Changeover Contacts	25
RE1P08DC048	8 pins	48V DC	2 Changeover Contacts	25
RE1P08DC110	8 pins	110V DC	2 Changeover Contacts	25
RE1P11AC012	11 pins	12V AC	3 Changeover Contacts	25
RE1P11AC024	11 pins	24V AC	3 Changeover Contacts	25
RE1P11AC048	11 pins	48V AC	3 Changeover Contacts	25
RE1P11AC110	11 pins	110V AC	3 Changeover Contacts	25
RE1P11AC220	11 pins	230V AC	3 Changeover Contacts	25
RE1P11DC012	11 pins	12V DC	3 Changeover Contacts	25
RE1P11DC024	11 pins	24V DC	3 Changeover Contacts	25
RE1P11DC048	11 pins	48V DC	3 Changeover Contacts	25
RE1P11DC110	11 pins	110V DC	3 Changeover Contacts	25



RS1P08G1

## Relay Sockets

Code	Number of Pins	Colour*	Box/Pcs
RS1P08*1	8 pins		10
RS1P11*1	11 pins		10

\*Colour; M: Blue, H: Black, G: Grey

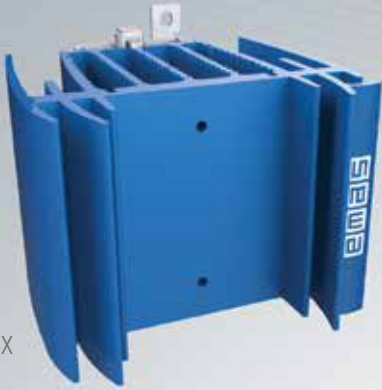

SSS5X



SSRP1DB012



RR3VP01



RZ3A1A60S2



RR3MP4FP



RR3MP1N



RZ4A3M708P



RZ4D1S208K



RR3ZTS30

# Electronic Products

## Solid State Relays



SSRP1DB040



SSRP1DA025

Code	Control Voltage	Mounting	Phase	Load Voltage Range	Max Load Current	Box/Pcs
SSRP1DA012	4 - 32 VDC	Base Mount	1 Phase	24-320V AC	12A	1
SSRP1DA025	4 - 32 VDC	Base Mount	1 Phase	24-320V AC	25A	1
SSRP1DA040	4 - 32 VDC	Base Mount	1 Phase	24-320V AC	40A	1
SSRP1DB012	4 - 32 VDC	Base Mount	1 Phase	50-480V AC	12A	1
SSRP1DB025	4 - 32 VDC	Base Mount	1 Phase	50-480V AC	25A	1
SSRP1DB040	4 - 32 VDC	Base Mount	1 Phase	50-480V AC	40A	1
SSRP1DC050	4 - 32 VDC	Base Mount	1 Phase	50-640V AC	50A	1
SSRP1DC070	4 - 32 VDC	Base Mount	1 Phase	50-640V AC	70A	1
SSRP1DC100	4 - 32 VDC	Base Mount	1 Phase	50-640V AC	100A	1
SSRP1DC120	4 - 32 VDC	Base Mount	1 Phase	50-640V AC	120A	1

## SSS Series Solid State Heat Sinks



SSS1X



SSS5X

Code	Installation	Dimension	Feature	Box/Pcs
SSS1X	Rail Type	45 x 75 mm	W/O Fan	1
SSS2X	Rail Type	45 x 100 mm	W/O Fan	1
SSS2F	Rail Type	45 x 100 mm	With Fan	1
SSS4X	Rail Type	100 x 75 mm	W/O Fan	1
SSS4F	Rail Type	100 x 75 mm	With Fan	1
SSS5X	Rail Type	100 x 100 mm	W/O Fan	1
SSS5F	Rail Type	100 x 100 mm	With Fan	1

## Rail Type Electronic Relays



SSS5F



RR3ZTS30

### Time Relays

Code	Operating Voltage	Time Range	Function				Control Output	Box/Pcs
			F1	F2	F3	F4		
RR3ZTC01	24 VDC/VAC-220VAC	0,06 sec. - 30 hour	√	√	√	√	1 Changeover Relay 10A/250V AC	10
RR3ZTC02*		0,6 sec. - 10 hour			√*	√*	1 Changeover Relay 10A/250V AC	10
RR3ZTS30		0,1-30 sec.adj			√		1 Changeover Relay 10A/250V AC	10
RR3ZTS60		0,1-60 sec.adj			√		1 Changeover Relay 10A/250V AC	10

F1.Delay ON Function / F2. Delay OFF Function / F3. ON Flasher Function / F4. OFF Flasher Function / F5. Bypass

\*In this model on-off times are separately adjustable.

### Voltage Protection



RR3VP01

Code	Operating Voltage	Time Delay Adjustment	Over Voltage Protection Level	Under Voltage Protection Level	Phase Sequence & Phase Loss Protection	Control Output	Box/Pcs
RR3VP01	220 VAC	0,1 - 20 sec.	230-300 VAC	150-210 VAC	Single Phase	1 Changeover Relay 10A/250VAC	10
RR3VP02		Adjustable	Adjustable	Adjustable	Three Phase	1 Changeover Relay 10A/250VAC	10

### Liquid Level Control



RR3LL01

Code	Operating Voltage	Electrode	Adjustment Sensitivity(kΩ)	Control Output	Box/Pcs
RR3LL01	220 VAC	Base, Bottom, Top	2 - 50	1 Changeover Relay 10A/250VAC	10

### Photocell Relay



RR3FR01

Code	Operating Voltage	Lux Scale	Time delay	Control	Protection	Control Output	Box/Pcs
RR3FR01	220 VAC	1-10 LUX	25s-40s	Automatic	-	1 changeover Relay 10A/250V AC	10
RR3FR02		1-10 LUX	25s-40s	Automatic or Manual	Fuse	1 changeover Relay 10A/250V AC	10

### Motor Protection

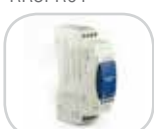

RR3MP1N

Code	Operating Voltage	Voltage Asymmetry	Phase Loss / Phase sequence	Thermal Protection	Control Output	Box/Pcs	
RR3MP1N	220V AC	%20	√		1 Changeover Relay 10A/250VAC	10	
RR3MP2N		%40	√		1 Changeover Relay 10A/250VAC	10	
RR3MP2F		%40	√	√		1 Changeover Relay 10A/250VAC	10
RR3MP2FP		%40	√	√	√	1 Changeover Relay 10A/250VAC	10
RR3MP4F		%5-15	√	√		1 Changeover Relay 10A/250VAC	10
RR3MP4FP		%5-15	√	√	√	1 Changeover Relay 10A/250VAC	10



RR3MP4FP



## Star Delta Relay

Code	Operating Voltage	Time Range	Function	Control Output	Box/Pcs
RR3YU01	220V AC	Star:3-30s, Star->Delta:50-500m	Star Delta	2NO relay 10A/250VAC	10
RR3YU02		Star:3-30s,Star-Delta:50-500ms, Right-Left:0.6s-5min	Star Delta & Right Left Relay	2NO relay 10A/250VAC	10



RZ3A1A30S2



RZ3A1A60S2

## Ø22 mm Electronic Time Relays

### Analog Time Relays

Code	Function	Time Range	Operating Voltage	Number of Contacts	Box/Pcs
RZ3A1A30M2	Delay On	0,5-30 min.	10-30V DC	PNP Transistor Output	1
RZ3A1A60M2	Delay On	1-60 min.	10-30V DC	PNP Transistor Output	1
RZ3A1A30S2	Delay On	0,1-30 sec.	10-30V DC	PNP Transistor Output	1
RZ3A1A60S2	Delay On	0,1-60 sec.	10-30V DC	PNP Transistor Output	1

## 36x36 mm Electronic Relays

### Analog Time Relays

#### With Single Relay



RZ1A1A12S-25

Code	Function	Time Range	Operating Voltage	Number of Contacts	Box/Pcs
RZ1A1A03*-1	Delay On	0.3 - 3 sec/m	12V AC/DC	1 Changeover Contact	1
RZ1A1A03*-25	Delay On	0.3 - 3 sec/m	24V AC/DC - 220V AC	1 Changeover Contact	1
RZ1A1A06*-1	Delay On	0.6 - 6 sec/m	12V AC/DC	1 Changeover Contact	1
RZ1A1A06*-25	Delay On	0.6 - 6 sec/m	24V AC/DC - 220V AC	1 Changeover Contact	1
RZ1A1A12*-1	Delay On	1.2 - 12 sec/m	12V AC/DC	1 Changeover Contact	1
RZ1A1A12*-25	Delay On	1.2 - 12 sec/m	24V AC/DC - 220V AC	1 Changeover Contact	1
RZ1A1A30*-1	Delay On	3 - 30 sec/m	12V AC/DC	1 Changeover Contact	1
RZ1A1A30*-25	Delay On	3 - 30 sec/m	24V AC/DC - 220V AC	1 Changeover Contact	1
RZ1A1A60S-1	Delay On	6 - 60 sec/m	12V AC/DC	1 Changeover Contact	1
RZ1A1A60S-25	Delay On	6 - 60 sec/m	24V AC/DC - 220V AC	1 Changeover Contact	1
RZ1A1B03*-1	Delay Off	0.3 - 3 sec/m	12V AC/DC	1 Changeover Contact	1
RZ1A1B03*-25	Delay Off	0.3 - 3 sec/m	24V AC/DC - 220V AC	1 Changeover Contact	1
RZ1A1B06*-1	Delay Off	0.6 - 6 sec/m	12V AC/DC	1 Changeover Contact	1
RZ1A1B06*-25	Delay Off	0.6 - 6 sec/m	24V AC/DC - 220V AC	1 Changeover Contact	1
RZ1A1B12*-1	Delay Off	1.2 - 12 sec/m	12V AC/DC	1 Changeover Contact	1
RZ1A1B12*-25	Delay Off	1.2 - 12 sec/m	24V AC/DC - 220V AC	1 Changeover Contact	1
RZ1A1B30*-1	Delay Off	3 - 30 sec/m	12V AC/DC	1 Changeover Contact	1
RZ1A1B30*-25	Delay Off	3 - 30 sec/m	24V AC/DC - 220V AC	1 Changeover Contact	1
RZ1A1B60S-1	Delay Off	6 - 60 sec/m	12V AC/DC	1 Changeover Contact	1
RZ1A1B60S-25	Delay Off	6 - 60 sec/m	24V AC/DC - 220V AC	1 Changeover Contact	1



RZ1A2C06S-2

#### With Double Relay

Code	Function	Time Range	Operating Voltage	Number of Contacts	Box/Pcs
RZ1A2C03*-1	Delay On & Delay Off	0.3 - 3 sec/m	12V AC/DC	1 Changeover Contact + 1Normally Open Contact	1
RZ1A2C03*-2	Delay On & Delay Off	0.3 - 3 sec/m	24V AC/DC	1 Changeover Contact + 1Normally Open Contact	1
RZ1A2C03*-5	Delay On & Delay Off	0.3 - 3 sec/m	220V AC	1 Changeover Contact + 1Normally Open Contact	1
RZ1A2C06*-1	Delay On & Delay Off	0.6 - 6 sec/m	12V AC/DC	1 Changeover Contact + 1Normally Open Contact	1
RZ1A2C06*-2	Delay On & Delay Off	0.6 - 6 sec/m	24V AC/DC	1 Changeover Contact + 1Normally Open Contact	1
RZ1A2C06*-5	Delay On & Delay Off	0.6 - 6 sec/m	220V AC	1 Changeover Contact + 1Normally Open Contact	1
RZ1A2C12*-1	Delay On & Delay Off	1.2 - 12 sec/m	12V AC/DC	1 Changeover Contact + 1Normally Open Contact	1
RZ1A2C12*-2	Delay On & Delay Off	1.2 - 12 sec/m	24V AC/DC	1 Changeover Contact + 1Normally Open Contact	1
RZ1A2C12*-5	Delay On & Delay Off	1.2 - 12 sec/m	220V AC	1 Changeover Contact + 1Normally Open Contact	1
RZ1A2C30*-1	Delay On & Delay Off	3 - 30 sec/m	12V AC/DC	1 Changeover Contact + 1Normally Open Contact	1
RZ1A2C30*-2	Delay On & Delay Off	3 - 30 sec/m	24V AC/DC	1 Changeover Contact + 1Normally Open Contact	1
RZ1A2C30*-5	Delay On & Delay Off	3 - 30 sec/m	220V AC	1 Changeover Contact + 1Normally Open Contact	1
RZ1A2C60S-1	Delay On & Delay Off	6 - 60 sec/m	12V AC/DC	1 Changeover Contact + 1Normally Open Contact	1
RZ1A2C60S-2	Delay On & Delay Off	6 - 60 sec/m	24V AC/DC	1 Changeover Contact + 1Normally Open Contact	1
RZ1A2C60S-5	Delay On & Delay Off	6 - 60 sec/m	220V AC	1 Changeover Contact + 1Normally Open Contact	1

\*Time Mode: S: second (sec); M: minute (m)

Note 1: 48x48 adaptor will be supplied free of charge whenever needed.

Note 2: All electronic relays must be used together with RS1P08 Sockets



RZ1D1B-1

Digital Time Relay														
Code	Operating Voltage	Number of Contacts	Time Range	Function*								Box/Pcs		
				A	B	F1	F2	S1	S2	S3	S4		I	P
RZ1D1S-1	12V AC/DC	1 Changeover Contact	0.1-99.59sn.	√	√	√	√	√	√	√	√	√	√	1
RZ1D1S-2	24V AC/DC	1 Changeover Contact	0.1-99.59sn.	√	√	√	√	√	√	√	√	√	√	1
RZ1D1S-4	110V AC	1 Changeover Contact	0.1-99.59sn.	√	√	√	√	√	√	√	√	√	√	1
RZ1D1S-5	220V AC	1 Changeover Contact	0.1-99.59sn.	√	√	√	√	√	√	√	√	√	√	1
RZ1D1B-1	12V AC/DC	1 Changeover Contact	0.1-99.59sn.	√	√	√	√	√	√	√	√	√	√	1
RZ1D1B-2	24V AC/DC	1 Changeover Contact	0.1-99.59sn.	√	√	√	√	√	√	√	√	√	√	1
RZ1D1B-5	220V AC	1 Changeover Contact	0.1-99.59sn.	√	√	√	√	√	√	√	√	√	√	1
RZ1D1R-1	12V AC/DC	1 Changeover Contact	0.1-99.59sn.	√	√	√	√	√	√	√	√	√	√	1
RZ1D1R-2	24V AC/DC	1 Changeover Contact	0.1-99.59sn.	√	√	√	√	√	√	√	√	√	√	1
RZ1D1R-5	220V AC	1 Changeover Contact	0.1-99.59sn.	√	√	√	√	√	√	√	√	√	√	1



RZ1D1C-5

Digital Counters					
Code	Operating Voltage	Number of Contacts	Counter Entry	Reset Entry	Box/Pcs
RZ1D1C-2	24V AC/DC	1 Changeover Contact	12-30V DC Pals	12-30V DC Pals	1
RZ1D1C-5	220V AC	1 Changeover Contact	12-30V DC Pals	12-30V DC Pals	1



RDA1A

Digital Panelmeters					
Code	Type	Operating Voltage	Number of Contacts	Counter Entry	Box/Pcs
RDA1A	Ampermeter	220/230V AC	1 Changeover Contact	0-5 A	1
RDV1A	Voltmeter	220/230V AC	1 Changeover Contact	0-600V AC	1
RDH1A	Frequencymeter	220/230V AC	1 Changeover Contact	100-250V AC / 30-70 Hz	1



RAM1S

RZ4A3M708P

Motor Protection Relay					
Code	Operating Voltage	Number of Contacts	Protection Phase Sequence	Protection Phase Loss	Box/Pcs
RAM1S	3x380V AC	1 Changeover Contact	√	√	1

## 48x48 mm Electronic Relays



RZ4A3M708P

Analog Time Relays															
Code	Operating Voltage	Number of Contacts	Time Range	Function*								Box/Pcs			
				B	F1	F2	S1	S2	S3	S4	I		P	R	
RZ4A3M708P	24/240V AC/DC	2 Changeover Contact	0.05 sec-100 hour	√	√	√	√								1
RZ4A3M708K	24/240V AC/DC	2 Changeover Contact	0.05 sec-100 hour	√	√	√	√								1

## Digital Time Relays

Code	Operating Voltage	Number of Contacts	Time Range	Function*										Box/Pcs		
				A	B	F1	F2	S1	S2	S3	S4	I	P		R	
RZ4D1S108P	12V AC/DC	1 Changeover Contact	0.1 sec-99 h.59 min	√	√	√	√	√	√	√	√	√	√	√	√	1
RZ4D1S208P	24V AC/DC	1 Changeover Contact	0.1 sec-99 h.59 min	√	√	√	√	√	√	√	√	√	√	√	√	1
RZ4D1S408P	110V AC	1 Changeover Contact	0.1 sec-99 h.59 min	√	√	√	√	√	√	√	√	√	√	√	√	1
RZ4D1S508P	230V AC	1 Changeover Contact	0.1 sec-99 h.59 min	√	√	√	√	√	√	√	√	√	√	√	√	1
RZ4D1S108K	12V AC/DC	1 Changeover Contact	0.1 sec-99 h.59 min	√	√	√	√	√	√	√	√	√	√	√	√	1
RZ4D1S208K	24V AC/DC	1 Changeover Contact	0.1 sec-99 h.59 min	√	√	√	√	√	√	√	√	√	√	√	√	1
RZ4D1S408K	110V AC	1 Changeover Contact	0.1 sec-99 h.59 min	√	√	√	√	√	√	√	√	√	√	√	√	1
RZ4D1S508K	230V AC	1 Changeover Contact	0.1 sec-99 h.59 min	√	√	√	√	√	√	√	√	√	√	√	√	1
RZ4D1B108P	12V AC/DC	1 Changeover Contact	0.1 sec-99 h.59 min	√	√	√	√	√	√	√	√	√	√	√	√	1
RZ4D1B208P	24V AC/DC	1 Changeover Contact	0.1 sec-99 h.59 min	√	√	√	√	√	√	√	√	√	√	√	√	1
RZ4D1B508P	230V AC	1 Changeover Contact	0.1 sec-99 h.59 min	√	√	√	√	√	√	√	√	√	√	√	√	1
RZ4D1B108K	12V AC/DC	1 Changeover Contact	0.1 sec-99 h.59 min	√	√	√	√	√	√	√	√	√	√	√	√	1
RZ4D1B208K	24V AC/DC	1 Changeover Contact	0.1 sec-99 h.59 min	√	√	√	√	√	√	√	√	√	√	√	√	1
RZ4D1B508K	230V AC	1 Changeover Contact	0.1 sec-99 h.59 min	√	√	√	√	√	√	√	√	√	√	√	√	1
RZ4D1R108P	12V AC/DC	1 Changeover Contact	0.1 sec-99 h.59 min	√	√	√	√	√	√	√	√	√	√	√	√	1
RZ4D1R208P	24V AC/DC	1 Changeover Contact	0.1 sec-99 h.59 min	√	√	√	√	√	√	√	√	√	√	√	√	1
RZ4D1R508P	230V AC	1 Changeover Contact	0.1 sec-99 h.59 min	√	√	√	√	√	√	√	√	√	√	√	√	1
RZ4D1R108K	12V AC/DC	1 Changeover Contact	0.1 sec-99 h.59 min	√	√	√	√	√	√	√	√	√	√	√	√	1
RZ4D1R208K	24V AC/DC	1 Changeover Contact	0.1 sec-99 h.59 min	√	√	√	√	√	√	√	√	√	√	√	√	1
RZ4D1R508K	230V AC	1 Changeover Contact	0.1 sec-99 h.59 min	√	√	√	√	√	√	√	√	√	√	√	√	1



RZ4D1S208K

## Digital Counters

Code	Operating Voltage	Number of Contacts	Counter Entry	Reset Entry	Box/Pcs
RZ4D1C208P	24V AC/DC	1 Changeover Contact	12-30V Dc Pals	12-30V Dc Pals	1
RZ4D1C508P	230V AC	1 Changeover Contact	12-30V Dc Pals	12-30V Dc Pals	1
RZ4D1C208K	24V AC/DC	1 Changeover Contact	12-30V Dc Pals	12-30V Dc Pals	1
RZ4D1C508K	230V AC	1 Changeover Contact	12-30V Dc Pals	12-30V Dc Pals	1



RZ4D1S208P

### \*Functions

A: Delay On
B: Delay Off
F1: Flasher with delay on energy
F2: Flasher with delay off energy
S1: Timing on energy with start input
S2: Delay on energy with start input
S3: Timing on energy with start input break
S4: Delay on energy with start input (2)
I: Waiting (Inhibit)
P: Start possibility from front panel
R: Reserve

## ECKR Electrical Device Protection Relay Protection against voltage changes after power cuts.

### ECKR Technical Features

Technical Information	
Mechanical Life	500.000
Electronic Life	10.000
Operating Temperature	-5/+40 °C
Insulation Class	IP 20
Operating Voltage	150-260V AC
Nominal Contact Current	40 A
Minimum, Maximum Voltage	150-260V AC
Maximum Contact Strength	10.500 VA
Operating Frequency	50 Hz
Operating Power	2 W
Maximum Peak Current	4500 A
Maximum Peak Voltage	6000 V
Weight	ECKR1D 147±5 gr. ECKR1A 140±5 gr.
Response Time	8 - 20 µs
Clamping Voltage	775 V
Clamping Current	I <sub>p</sub> 50 Amp.
Protection Capacity	125 J (joules)
Standard	TS EN 60255

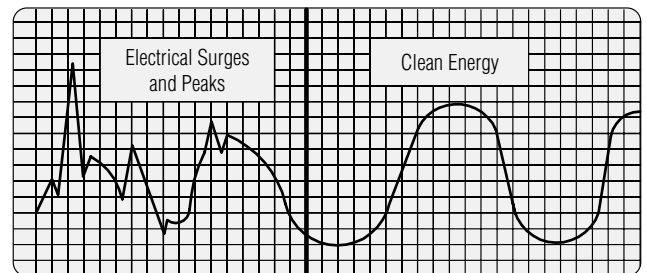

### ECKR APPLICATION SCHEME

ECKR1D-ECKR1A

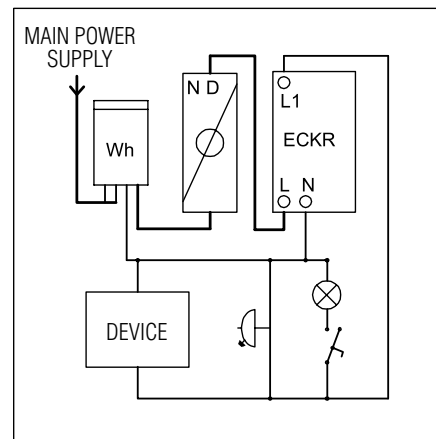
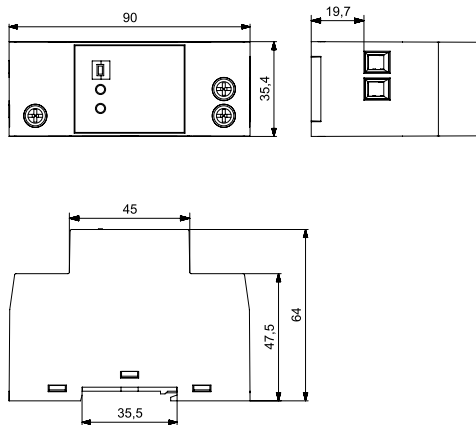

ECKR1A



ECKR1D

Code	Features	Nominal Voltage	Box/Pcs
ECKR1A	Analog	220V AC	1
ECKR1D	Digital (with Voltage display)	220V AC	1



L51K23LUM324

# Safety Products





CP200EP



CP200EA30

## Emergency Stop Button

### CP/CM Series Emergency Stop

Code	Type	Contact Block	Dia (mm)	Colour	Box/Pcs
CP200E30		1 NC	30	●	10
CP200ES30	With Signal	1 NC	30	●	10
CP200EA30	Key Operated	1 NC	30	●	10
CP200ECN30	Pull to Release	1 NC	30	●	10
CP200ECS30	With Signal, Pull to Release	1 NC	30	●	10
CP200EE	Turn to Release	1 NC	40	●	10
CP200EE	Turn to Release, With Label	1 NC	40	●	10
CP200EK30	Turn to Release	1 NC	30	●	10
CP200EP	With Window	1 NC	40	●	10
CM200E	Mushroom	1 NC	40	●	10
CM200EE	Turn to release with Label	1 NC	40	●	10



B200E30



B200EE

### B Series Emergency Stop

Code	Type	Contact Block	Dia (mm)	Colour	Box/Pcs
B200E30		1 NC	30	●	10
B102E30		1 NO + 1 NC	30	●	10
B200E		1 NC	40	●	10
B200EE	With Plate	1 NC	40	●	10
B102E		1 NO + 1 NC	40	●	10
B200E60		1 NC	60	●	5
B102E60		1 NO + 1 NC	60	●	5
B200EG		1NC	40	●	10



KB12E

### KB Series Emergency Stop

Code	Contact Block	Colour	Box/Pcs
KB12E	1 NC	●	10
KB14E	1 NO + 1 NC	●	10



H200EE

### H Series Emergency Stop (30 mm)

Code	Type	Contact Block	Dia (mm)	Colour	Box/Pcs
H200EE	Turn to release with label	1 NC	40	●	10



PK1SE

## Emergency Stop Control Box

### PK Series

Code	Button Qty	Features	Box Colour	Box/Pcs
PK1SE	Single	With Emergency Stop Button	Yellow-Black	1



P1EC400E40K



P1C400E72

### P Series (Plastic Enclosed)

Code	Button Qty	Features	Box Colour	Box/Pcs
P1EC400E40	Single	Emergency Stop	Yellow-Black	1
P1EC400E40K	Single	Emergency Stop, With Plate	Yellow-Black	1
P1C400E72	Single	72mm. Emergency Stop	Grey-Black	1
PA304E40LED1	Single	Emergency Stop, With LED Label	Yellow-Black	1



M1C200E40

### M Series (Metal Enclosed)

Code	Button Qty	Features	Box Colour	Box/Pcs
M1C200E40	Single	Emergency Stop	Yellow-Grey	1
M1C200EE	Single	Emergency Stop, With Label	Yellow-Grey	1



L5K23LEM411



L5K23BEM621



L5K23LUM324



L5K23LUM323

## Limit Switches

### L5 Series, Plastic Body Slow Action

Code	Actuator	Actuator Type	End Unit Material	Box/Pcs
L5K23LEM411*	Hinge	Plastic	Metal	1
L5K23LEM412*	Hinge	Plastic	Metal	1
L5K23LEM511*	Hinge	Plastic	Metal	1
L5K23LEM621*	Hinge	Plastic	Metal	1
L5K23LEM622*	Hinge	Plastic	Metal	1
L5K23BEM621*	Rotational Tube	Plastic	Metal	1
L5K23LUM321*	Curved Key	Plastic	Metal	1
L5K23LUM322*	Straight Key	Plastic	Metal	1
L5K23LUM323*	Movable Key	Plastic	Metal	1
L5K23LUM324*	Movable Key	Plastic	Metal	1
L5K23CPDE*	Emergency Stop	Plastic	Plastic	1



L51K23LUM321



L51K23HUM112

### L51 Series, Metal Body, Slow Action

Code	Actuator	Actuator Type	End Unit Material	Box/Pcs
L51K23LUM321*	Curved Key	Metal	Metal	1
L51K23LUM322*	Straight Key	Metal	Metal	1
L51K23LUM323*	Movable Key	Metal	Metal	1
L51K23LUM324*	Movable Key	Metal	Metal	1
L51K23HUM111*	Metal Ring	Metal	Metal	1
L51K23HUM112*	Metal Ring, with Reset	Metal	Metal	1



L52K23HUM111



L52K23HUM112

### L52 Series, Metal Body, Slow Action

Code	Actuator	Actuator Type	End Unit Material	Box/Pcs
L52K23LUM321*	Curved Key	Metal	Metal	1
L52K23LUM322*	Straight Key	Metal	Metal	1
L52K23LUM323*	Movable Key	Metal	Metal	1
L52K23LUM324*	Movable Key	Metal	Metal	1
L52K23HUM111*	Metal Ring	Metal	Metal	1
L52K23HUM112*	Metal Ring, with Reset	Metal	Metal	1

\* Positive Opening Function →



CEKPB



CEKPAB

### Two Hand Control Panel

Code	Description	Base
CEKP3	2 Sides, 3 Middle Hole	
CEKP3G	2 Sides, 3 Middle Hole, Grey	
CEKP5	2 Sides, 5 Middle Hole	
CEKPA	2 Sides, 1 Middle Hole	✓
CEKPB	1 pcs CM200E (middle), 2 pcs CM200MY (2 sides)	
CEKPAB	1 pcs CM200E (middle), 2 pcs CM200MY (2 sides)	✓

Code	Accessories
CEKA	Base For Two Hand Panel



CSM02

VT2050

VTKAMD

VTKAMA

CSM10

# Crane Products

## Crane Control Boxes



PVK2E



PVK4E

### PVK Series IP 65

Code	Button Qty	Box Colour	Box/Pcs
PVK2E	2	Yellow-Black	1
PVK3E	3	Yellow-Black	1
PVK4E	4	Yellow-Black	1
PVK5E	5	Yellow-Black	1
PVK6E	6	Yellow-Black	1
PVK7E	7	Yellow-Black	1
PVK8E	8	Yellow-Black	1



PV3E30B4



PV5T144

### PV Series IP 65

Code	Button Qty	Speed	Box Colour	Box/Pcs
PV3T12	2	Single Speed	Yellow-Black	1
PV3T14	2	Double Speed	Yellow-Black	1
PV3E30B2	3	Single Speed	Yellow-Black	1
PV3E30B4	3	Double Speed	Yellow-Black	1
PV4Z22	4	Single Speed	Yellow-Black	1
PV4Z42	4	Double-Single Speed	Yellow-Black	1
PV4Z44	4	Double Speed	Yellow-Black	1
PV5T122	4	Single Speed	Yellow-Black	1
PV5T144	4	Double Speed	Yellow-Black	1
PV5E30B22	5	Single Speed	Yellow-Black	1
PV5E30B42	5	Double-Single Speed	Yellow-Black	1
PV5E30B44	5	Double Speed	Yellow-Black	1
PV7T1222	6	Single Speed	Yellow-Black	1
PV7T1444	6	Double Speed	Yellow-Black	1
PV7E30B222	7	Single Speed	Yellow-Black	1
PV7E30B444	7	Double Speed	Yellow-Black	1
PV9T12222	8	Single Speed	Yellow-Black	1
PV9T14444	8	Double Speed	Yellow-Black	1
PV9E30B2222	9	Single Speed	Yellow-Black	1
PV9E30B222AA20	8	Single Speed	Yellow-Black	1
PV9E30B4444	9	Double Speed	Yellow-Black	1



PV7E30B444



PV9E30B4444



PV9E30B222AA20



PVCHBD - PVCHSD - PVTHBD - PVTHSD

### PV Series Spare Parts

Code	Type	Speed	Colour	Box/Pcs
PVB1	Start Contact Block	-	●	20
PVB2	Stop Contact Block	-	●	20
PVCHBD	Button	Double Speed	○	20
PVCHSD	Button	Double Speed	●	20
PVTHBD	Button	Single Speed	○	20
PVTHSD	Button	Single Speed	●	20

NEW



CSM10



CSM02

## Cross Limit Switch, Metal Body, IP 65

Code	Features	Box/Pcs
CSM02	1 forward step, 1 reverse step	1
CSM04	2 forward steps, 2 reverse steps	1
CSM10	Eternal	1

CSM02

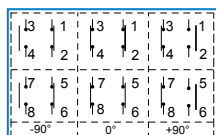

CSM04

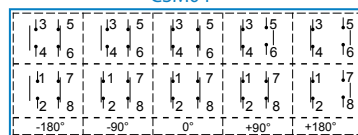

CSM10

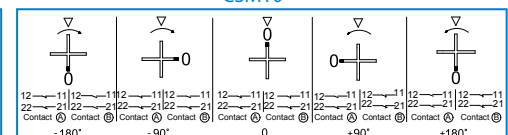



VT2050



VT4300

## Rotational Limit Switch, IP67

Code	Switch Quantity	Cam Degree	Box/Pcs
VT2***	2	20°	1
VT3***	3	20°	1
VT4***	4	20°	1
VT2***D	2	60°	1
VT3***D	3	60°	1
VT4***D	4	60°	1

Note: Ratios are 1/50, 1/75, 1/100, 1/150, 1/200, 1/300  
 For ratios, please fill 3 digit number instead of \*\*\*  
 i.e.: VT2050 means 2 switch qty and 050 ratios

## Accessories for Rotational Limit Switch



Code	Cam Degree
VTKAMA	20°
VTKAMD	60°
VTKAPLİN	



VTKAMA



VTKAMD





PA1E40K



PA2E40P1

# Lift Products

## Lift Push Button Stations

Code	Number of Holes	Features	Box Colour	Box/Pcs
PA1BOS	1	1 Hole Empty Plastic Enclosure	Yellow-Black	1
PA1E40K	1	1 pcs. Emergency Stop, with plastic 60mm Emergency Stop Legend Plate	Yellow-Black	1
PA2BOS	2	2 Hole Empty Plastic Enclosure	Yellow-Black	1
PA2E40P1	1	1 pcs. Emergency Stop, European Schuko Type Socket	Yellow-Grey	1
PA3311	3	1 pcs. Emergency, 1 pcs. Double Push Button, 1pcs. European Schuko Type Socket	Yellow-Grey	1
PA3BOS	3	3 Hole Empty Plastic Enclosure	Yellow-Black	1
PA4401	4	1 pcs. Emergency Stop, 1 pcs. Flush Push Button (Arrow Signed), 1 pcs. Double Push Button (Arrow Signed), 1 pcs. Rotary Cam Switch	Yellow-Black	1
PA4403	4	1 pcs. Emergency Stop, 1 pcs. Flush Push Button (Arrow Signed), 1 pcs. Double Push Button (Arrow Signed), 1 pcs. Rotary Cam Switch	Yellow-Black	1
PA4404	4	1 pcs. Emergency Stop, 1 pcs. Flush Push Button (Arrow Signed), 1 pcs. Double Push Button (Arrow Signed), 1 pcs. Rotary Cam Switch, 1 Cable Gland	Yellow-Black	1
PA4405	4	1 pcs. Emergency Stop, 1 pcs. Flush Push Button (Arrow Signed), 1 pcs. Double Push Button (Arrow Signed), 1 pcs. Rotary Cam Switch, 1 pcs. Cable Gland	Yellow-Black	1
PA4406	4	1 pcs. Emergency Stop with Window, 2 pcs. Flush Push Button (Arrow Signed), 1 pcs. Rotary Cam Switch	Yellow-Black	1
PA4411	4	1 pcs. Emergency Stop, 1 pcs. Selector, 1 pcs. Flush Push Button, 1 pcs. Plug	Yellow-Black	1
PA4412	4	1 pcs. Emergency Stop, 1 pcs. Flush Push Button (Bell Signed), 1 pcs. Flush Push Button (Light Signed), 1 pcs. Rotary Cam Switch	Yellow-Black	1
PA4443	4	1 pcs. Emergency Stop with Window, 1 pcs. Double Push Button (Arrow Signed), 1 pcs. Double Push Button (Bell and Lamp Signed), 1 pcs. Rotary Cam Switch	Yellow-Black	1
PA4BOS	4	4 Hole Empty Plastic Enclosure	Yellow-Black	1
PA5501	5	2 pcs. Arrow Signed, 1 pcs. Emergency Stop, 1 pcs. Rotary Cam Switch, 1 pcs. Signal, 1 pcs. European Schuko Type Socket	Yellow-Black	1
PA5BOS	5	5 Hole Empty Plastic Enclosure	Yellow-Black	1
PA6601	6	1 pcs. Emergency Stop, 1 pcs. Double Push Button, 2 pcs. Selector, 1 pcs. Rotary Cam Switch, 1 pcs. Flush Push Button	Yellow-Black	1
PA6BOS	6	6 Hole Empty Plastic Enclosure	Yellow-Black	1
PA8801	8	1 pcs. Arrow Signed, 1 pcs. Flush Push Button, 1 pcs. Rotary Cam Switch, 1 pcs. Double Push Button, 2 pcs. Selector, 1 pcs. Emergency Stop	Yellow-Black	1
PA8BOS	8	8 Hole Empty Plastic Enclosure	Yellow-Black	1
PA9BOS	9	9 Hole Empty Plastic Enclosure	Yellow-Black	1
PA9E40P2	9	4 pcs. Start Push Button, 1 pcs. European Schuko Type Socket, 1 pcs. Emergency Stop, 1 pcs. Selector	Yellow-Black	1
PARK4B	3	2 pcs. Arrow Signed Flush Push Button Push Button, 1 pcs. Emergency Stop (B Type)	Yellow-Black	1
PARK4SB	4	2 pcs. Arrow Signed Flush Push Button Push Button, 1 pcs. Emergency Stop, 1 pcs. Selector (B Type)	Yellow-Black	1
PARKBOS	0		Yellow-Black	1
PY4ASB2	4	2 pcs. Arrow Signed Flush Push Button, 1 pcs. Emergency Stop, 1 pcs. Selector, 8 Contact (B Type)	Yellow-Black	1
PY4ASM1	4	2 pcs. Arrow Signed Flush Push Button, 1 pcs. Emergency Stop, 1 pcs. Selector, 4 Contact (Monoblock)	Yellow-Black	1
PY4ASM2	4	2 pcs. Arrow Signed Flush Push Button, 1 pcs. Emergency Stop, 1 pcs. Selector, 7 Contact (Monoblock)	Yellow-Black	1

Note: Control Boxes have IP65 protection degree, but the minimum IP of the button is accepted for the complete product.



PARK4SB



PA1BOS



PA1E40K



PA2BOS



PA2E40P1



PA3BOS



PA3311



PA4BOS



PA4411



PA4412



PA4401



PA4402



PA4443



PA5BOS



PA5501



PA6BOS



PA6601



PA8BOS



PA8801



PA9BOS



PA9E40P2



PY4ASB2



Z70



Z71

## Elevator Door Switches

Code	Type	Box/Pcs
Z70	Plug	16
Z71	Socket-Single Entry	16
Z72	Socket-Double Entry	16
Z73	Plug	16
Z74	Socket-Single Entry	16



Z73



Z74

## Limit Switches

Code	Actuator	Actuator Type	End Unit Material
L5K13MEL123*	Angular Action Roller Two Way	Plastic	Rubber
L5K13MEL123A*	Angular Action Roller Two Way	Plastic	Rubber
L5K13MEL123R	Angular Action Roller Two Way, Adjustable	Plastic	Rubber
L5K23MUM331R*	Linear Roller, with Reset	Plastic	Metal
L5K23MUM332R*	Linear Roller, with Reset	Plastic	Metal
L51K13MEL123*	Angular Action Roller Two Way	Metal	Rubber
L51K13MEL123A*	Angular Action Roller Two Way	Metal	Rubber
L51K23MUM331R*	Linear Roller, with Reset	Metal	Metal
L51K23MUM332R*	Linear Roller, with Reset	Metal	Metal

\* Positive Opening Features



L5K23MUM332R



L5K13MEL123A

## ByPass Cam Switches

Code	Rated Thermal Current (A)	Place of Usage	Scheme
PSA010ZL123S	10A	-	
PSA010ZL123AR	10A	-	
PSA010ZR221S	10A	-	
PSA010ZR221AR	10A	-	
PSA020KD340AR	20A	PA4401, PA4402, PA5501, PA6601, PA8801	
PSA020ZA431AR	20A	PA8811	
PSA020ZT332AR	20A	PA4405	
PSA020ZS332AR	20A	PA4403, PA4404, PA4443	



HKP040060R5A



HKP020025ZEA



HKP015015R1A



HKP020025R3A



HKP020025ZKA

# Cable Carriers



HKP015015R1A



HKP020025R3A



HKP040060R5A



HKP015015ZDA



HKP015015ZEA

Code	Material	Inner Height	Inner Width	Bending Radius	Type	Box/Pcs
HKP015015R1A	Plastic	15 mm	15 mm	25 mm	Open	1 x 1 m
HKP020025R3A	Plastic	20 mm	25 mm	40 mm	Open	1 x 1 m
HKP040060R5A	Plastic	40 mm	60 mm	100 mm	Open	1 x 1 m

Code	Material	Inner Height	Inner Width	Features	Box/Pcs
HKP015015ZDA	Plastic	15 mm	15 mm	Internal Connection	10
HKP015015ZEA	Plastic	15 mm	15 mm	External Connection	10
HKP015015ZKA	Plastic	15 mm	15 mm	Upper	100
HKP020025ZDA	Plastic	20 mm	25 mm	Internal Connection	10
HKP020025ZEA	Plastic	20 mm	25 mm	External Connection	10
HKP020025ZKA	Plastic	20 mm	25 mm	Upper	100
HKP040060ZDA	Plastic	40 mm	60 mm	Internal Connection	1
HKP040060ZEA	Plastic	40 mm	60 mm	External Connection	1
HKP040060ZKA	Plastic	40 mm	60 mm	Upper	20
HKP040060ZSA	Plastic	40 mm	-	Separator	20



HKP020025ZDA



HKP020025ZEA



HKP020025ZKA



HKP040060ZSA



## B Series Control Units Selection Table

Series	Contact Block Combination			Button Type	Colour	Pad Printing
<b>B</b>	<b>1</b>	<b>K</b>	<b>2</b>	<b>D</b>	<b>K</b>	<b>1</b>
<b>B</b> B Series Ø 22 mm Control Units	<b>Contact Block Type</b> <b>1</b> Start - For Button <b>2</b> Stop - For Button	<b>Contact Block Type</b> <b>0</b> Empty <b>1</b> Start - For Button <b>2</b> Stop - For Button	<b>Illumination Block Type</b> <b>0</b> Empty <b>B</b> 100-230 V AC/DC With White LED <b>K</b> 100-230 V AC/DC With Red LED <b>M</b> 100-230 V AC/DC With Blue LED <b>S</b> 100-230 V AC/DC With Yellow LED <b>Y</b> 100-230 V AC/DC With Green LED <b>5</b> 12-30 V AC/DC With White LED <b>6</b> 12-30 V AC/DC With Red LED <b>7</b> 12-30 V AC/DC With Blue LED <b>8</b> 12-30 V AC/DC With Yellow LED <b>9</b> 12-30 V AC/DC With Green LED <b>Q</b> 48 V AC/DC With White LED <b>X</b> 48 V AC/DC With Red LED <b>V</b> 48 V AC/DC With Blue LED <b>W</b> 48 V AC/DC With Yellow LED <b>Z</b> 48 V AC/DC With Green LED <b>C</b> 110 V AC/DC With White LED <b>D</b> 110 V AC/DC With Red LED <b>E</b> 110 V AC/DC With Blue LED <b>F</b> 110 V AC/DC With Yellow LED <b>G</b> 110 V AC/DC With Green LED <b>3*</b> Illumination Block Suitable for Ba9S Bulbs	<b>Spring Type</b> <b>D</b> Flush <b>F</b> Stay Put <b>H</b> Extended <b>M</b> Mushroom Ø 40 mm <b>Key Operated Type</b> <b>AA20</b> 2 Position, Stay Put (0-I) ↕ <b>AA21</b> 2 Position, Spring Return (0-I) ↕ <b>AA30</b> 3 Position, Stay Put (II-0-I) ↕ <b>AA31</b> 3 Position, Single Spring Return (II-0-I) ↕ <b>AA32</b> 3 Position, Double Spring Return (II-0-I) ↕ <b>AC20</b> 2 Position, Stay Put (II-0-I) ↕ <b>AC30</b> 3 Position, Stay Put (II-0-I) ↕ Ω Taking key out position <b>Selector Type</b> <b>S20</b> 2 Position, Stay Put (0-I), 60° ↙ <b>S21</b> 2 Position, Spring Return (0-I), 60° ↗ <b>S30</b> 3 Position, Stay Put (II-0-I), 60° ↘ <b>S31</b> 3 Position, Single Spring Return (II-0-I), 60° ↘ <b>S32</b> 3 Position, Double Spring Return (II-0-I), 60° ↘ <b>SL20</b> 2 Position, Illuminated Stay Put (0-I) ↙ <b>SL21</b> 2 Position, Illuminated Spring Return (0-I) ↗ <b>SL30</b> 3 Position, Illuminated Stay Pu (II-0-I) ↘ <b>SL31</b> 3 Position, Illuminated Single Spring Return (II-0-I) ↘ <b>SL32</b> 3 Position, Illuminated Double Spring Return (II-0-I) ↘ <b>T20</b> 2 Position, Stay Put (0-I), 90° ∨ <b>T21</b> 2 Position, Spring Return (0-I), 90° ∨ <b>R20</b> 2 Position, Stay Put (0-I), 45° ↙ <b>R21</b> 2 Position, Spring Return (0-I), 45° ↗ <b>C</b> Handle Switch <b>Emergency Stop Type</b> <b>E30</b> Ø 30 mm, Turn to Release <b>E</b> Ø 40 mm, Turn to Release <b>EE</b> Ø 40 mm, With Label, Turn to Release <b>E60</b> Ø 60 mm, Turn to Release <b>EG</b> Ø 40 mm With Position Curser Turn to Release <b>Double Type</b> <b>K20</b> Flush <b>K21</b> Flush, Single Extender <b>K22</b> Flush, Double Extender <b>B20</b> Big Double Flush <b>B30</b> Triple Signle Extended Stop <b>X</b> Pilots	<b>Colour</b> <b>B</b> White <b>K</b> Red <b>M</b> Blue <b>S</b> Yellow <b>Y</b> Green <b>H</b> Black Mat	<b>0</b> 0 Printed <b>10</b> I-0 Printed <b>1</b> I Printed <b>2</b> II Printed <b>12</b> I-II Printed <b>L</b> LIGHT Printed <b>OD</b> OK Vertical Printed <b>OY</b> OK Horizontal Printed <b>OK</b> OK Special Printed <b>OO</b> OK Special Printed <b>S</b> Siren Sign <b>Z</b> Bell Sign

\*Only for B Series

**Example:** B1K2DK → B series, start, stop, 100 - 230V AC, With Red LED, red flush type control unit has been selected.

## C Series Control Units Selection Table

Series Material		Contact Block Combination			Button Type	Colour	Pad Printing
<b>CM</b>		<b>1</b>	<b>K</b>	<b>2</b>	<b>D</b>	<b>K</b>	<b>1</b>

<p><b>CP</b> CP Series Plastic Ø 22 mm Control Units</p> <p><b>CM</b> CM Series Metal Ø 22 mm Control Units</p>	<p><b>0</b> Empty</p> <p><b>1</b> Start For Button</p> <p><b>2</b> Stop For Button</p> <p><b>3</b> Tandem Start - Start</p> <p><b>4</b> Tandem Start - Stop</p> <p><b>5</b> Tandem Stop - Stop</p>	<p><b>Illumination Block Type</b></p> <p><b>0</b> Empty</p> <p><b>B</b> 100-230 V AC/DC With White LED</p> <p><b>K</b> 100-230 V AC/DC With Red LED</p> <p><b>M</b> 100-230 V AC/DC With Blue LED</p> <p><b>S</b> 100-230 V AC/DC With Yellow LED</p> <p><b>Y</b> 100-230 V AC/DC With Green LED</p> <p><b>5</b> 12-30 V AC/DC With White LED</p> <p><b>6</b> 12-30 V AC/DC With Red LED</p> <p><b>7</b> 12-30 V AC/DC With Blue LED</p> <p><b>8</b> 12-30 V AC/DC With Yellow LED</p> <p><b>9</b> 12-30 V AC/DC With Green LED</p> <p><b>Q</b> 48 V AC/DC With White LED</p> <p><b>X</b> 48 V AC/DC With Red LED</p> <p><b>V</b> 48 V AC/DC With Blue LED</p> <p><b>W</b> 48 V AC/DC With Yellow LED</p> <p><b>Z</b> 48 V AC/DC With Green LED</p> <p><b>C</b> 110 V AC/DC With White LED</p> <p><b>D</b> 110 V AC/DC With Red LED</p> <p><b>E</b> 110 V AC/DC With Blue LED</p> <p><b>F</b> 110 V AC/DC With Yellow LED</p> <p><b>G</b> 110 V AC/DC With Green LED</p> <p><b>N</b> 220V DC With White LED</p> <p><b>O</b> 220V DC With Red LED</p> <p><b>P</b> 220V DC With Blue LED</p> <p><b>R</b> 220V DC With Yellow LED</p> <p><b>T</b> 220V DC With Green LED</p>	<p><b>Spring Type</b></p> <p><b>D</b> Flush</p> <p><b>F</b> Stay Put</p> <p><b>M</b> Mushroom Ø 40 mm</p> <p><b>H</b> Extended</p> <p><b>Key Operated Type Buttons</b></p> <p><b>AA20</b> 2 Position, Stay Put (0-I) ↕</p> <p><b>AA21</b> 2 Position, Spring Return (0-I) ↕↗</p> <p><b>AA30</b> 3 Position, Stay Put (II-0-I) ↕</p> <p><b>AA31</b> 3 Position, Single Spring Return (II-0-I) ↕↗</p> <p><b>AA32</b> 3 Position, Double Spring Return (II-0-I) ↕↗↘</p> <p><b>AC20</b> 2 Position, Stay Put (II-0-I) ↕↗</p> <p><b>AC30</b> 3 Position, Stay Put (II-0-I) ↕↗↘</p> <p>Ω Taking key out position</p> <p><b>Selector Type</b></p> <p><b>S20</b> 2 Position, Stay Put (0-I), 60° ↘</p> <p><b>S21</b> 2 Position, Spring Return (0-I), 60° ↗</p> <p><b>S30</b> 3 Position, Stay Put (II-0-I), 60° ↘</p> <p><b>S31</b> 3 Position, Single Spring Return (II-0-I), 60° ↗↘</p> <p><b>S32</b> 3 Position, Double Spring Return (II-0-I), 60° ↗↘↘</p> <p><b>Joystick</b></p> <p><b>DJ20</b> 2 Position, Stay Put</p> <p><b>DJ21</b> 2 Position, Spring Return</p> <p><b>DJ40</b> 4 Position, Stay Put</p> <p><b>DJ41</b> 4 Position, Spring Return</p> <p><b>Emergency Stop Type (Only CP Plastic Series)</b></p> <p><b>E30</b> Ø 30 mm, Turn to Release*</p> <p><b>EK30</b> Ø 30 mm, Short, Turn to Release*</p> <p><b>EA30</b> Ø 30 mm, Key Operated, Turn to Release*</p> <p><b>ES30</b> Ø 30 mm, With Signal, Turn to Release*</p> <p><b>ECN30</b> Ø 30 mm, Pull to Release*</p> <p><b>ECS30</b> Ø 30 mm, With Signal, Pull to Release*</p> <p><b>E</b> Ø 40 mm, Turn to Release</p> <p><b>EC</b> Ø 40 mm, Pull to Release</p> <p><b>EE</b> Ø 40 mm, Turn to Release, With Label</p> <p><b>EP</b> Ø 40 mm, With Window, Pull to Release</p> <p>* Snap Locked</p> <p><b>Double Head Buttons</b></p> <p><b>K20</b> Flush</p> <p><b>K21</b> Single Extended</p> <p><b>X</b> Pilots</p>	<p><b>Colour</b></p> <p><b>B</b> White</p> <p><b>K</b> Red</p> <p><b>M</b> Blue</p> <p><b>S</b> Yellow</p> <p><b>Y</b> Green</p> <p><b>H</b> Black Mat</p>	<p><b>0</b> 0 Printed</p> <p><b>10</b> I-0 Printed</p> <p><b>1</b> I Printed</p> <p><b>2</b> II Printed</p> <p><b>12</b> I-II Printed</p> <p><b>L</b> LIGHT Printed</p> <p><b>OD</b> OK Vertical Printed</p> <p><b>OY</b> OK Horizontal Printed</p> <p><b>OK</b> OK Special Printed</p> <p><b>OO</b> OK Special Printed</p> <p><b>S</b> Siren Sign</p> <p><b>Z</b> Bell Sign</p>
---	--	---	---	--	--

**Example:** CM1K2DK → C Series, Metal, start, stop, 100 - 230V AC, with red LED, red flush type control unit has been selected.

## D Series Control Units Selection Table

Series	Contact Block Combination			Button Shape	Button Type	Colour
<b>D</b>	<b>1</b>	<b>6</b>	<b>2</b>	<b>D</b>	<b>D</b>	<b>K</b>
<b>Series</b> <b>D</b> D Series Ø 16 mm Control Units	<b>Button Shape</b> <b>0</b> Empty <b>1</b> Start For Button <b>2</b> Stop For Button			<b>Button Type</b> <b>D</b> Flush <b>M30</b> Mushroom Ø 30 mm	<b>Colour</b> <b>K</b>	<b>Contact Block Type</b> <b>0</b> Empty <b>1</b> Start For Button <b>2</b> Stop For Button
<b>Button Shape</b> <b>0</b> Empty <b>1</b> Start For Button <b>2</b> Stop For Button	<b>Contact Block Type</b> <b>D</b> Rectangle <b>K</b> Square <b>Y</b> Round			<b>Spring Type</b> <b>D</b> Flush <b>M30</b> Mushroom Ø 30 mm	<b>Selector Type</b> <b>S20</b> 2 Position Stay Put (0-I) 60° ↙ <b>S21</b> 2 Position Stay Return (0-I) 60° ↘ <b>S30</b> 3 Position Stay Put (II-0-I) 60° ↙ <b>S31</b> 3 Position Single Stay Return (II-0-I) 60° ↘ <b>S32</b> 3 Position Double Stay Return (II-0-I) 60° ↕	<b>Emergency Stop Type</b> <b>E30</b> Ø 30mm Turn to Release
<b>Illumination Block Type</b> <b>0</b> Empty <b>5</b> 12 - 24V AC/DC With White LED <b>6</b> 12 - 24V AC/DC With Red LED <b>7</b> 12 - 24V AC/DC With Blue LED <b>8</b> 12 - 24V AC/DC With Yellow LED <b>9</b> 12 - 24V AC/DC With Green LED	<b>Pilots</b> <b>X</b> Pilots			<b>Colour</b> <b>B</b> White <b>K</b> Red <b>M</b> Blue <b>S</b> Yellow <b>Y</b> Green <b>H</b> Black Mat		

**Example:** D162DDK—→D Series, start,stop,12 - 24V AC/DC, With Red LED, Red Rectangle flush type control unit has been selected.

## MB Series Monoblock Ø22 mm Control Units Selection Table

Series	Contact Combination			Button Type	Colour	Pad Printing
<b>MB</b>	<b>1</b>	<b>0</b>	<b>2</b>	<b>D</b>	<b>K</b>	<b>1</b>

**Series**

**MB** Series Monoblock Ø 22mm Control Units

**Contact Block Type**

**1** Start For Button

**2** Stop For Button

**Contact Block Type**

**1** Start For Button

**2** Stop For Button

**Illumination Block Type**

**0** Empty

**Button Type**

**Spring Type**

- D** Flush
- F** Stay Put
- H** Extended
- M** Mushroom Ø 40 mm

**Selector Type**

<b>S20</b>	2 Position	Stay Put	(0-I)	60°	↙
<b>S21</b>	2 Position	Spring Return	(0-I)	60°	↘
<b>S30</b>	3 Position	Stay Put	(II-0-I)	60°	↙
<b>S31</b>	3 Position	Single Spring Return	(II-0-I)	60°	↘
<b>S32</b>	3 Position	Double Spring Return	(II-0-I)	60°	↘↙

**Emergency Stop Type**

- E** Ø 40mm Turn to Release
- EE** Ø 40mm With Label Turn to Release

**Pilots**

- X** Pilots

**B** White

**K** Red

**M** Blue

**S** Yellow

**Y** Green

**H** Black

**0** 0 Printed

**10** I-0 Printed

**1** I Printed

**2** II Printed

**12** I-II Printed

**L** LIGHT Printed

**OD** OK Vertical Printed

**OY** OK Horizontal Printed

**OK** OK Special Printed

**00** OK Special Printed

**S** Siren Sign

**Z** Bell Sign

**Example:** MB102DK → MB Series, start, stop, Red flush type control unit has been selected.

## Limit Switches Selection Table



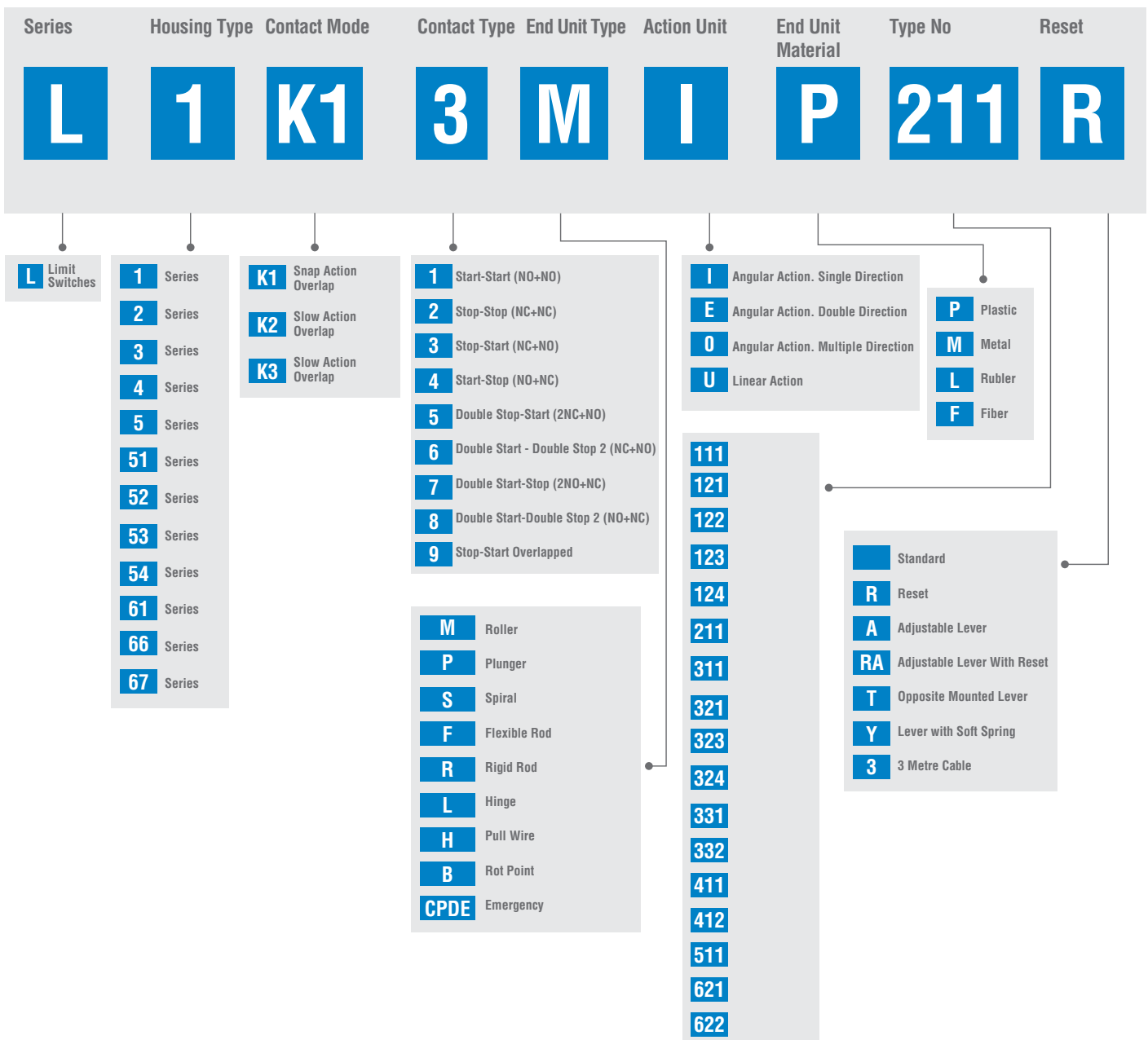

## Standard

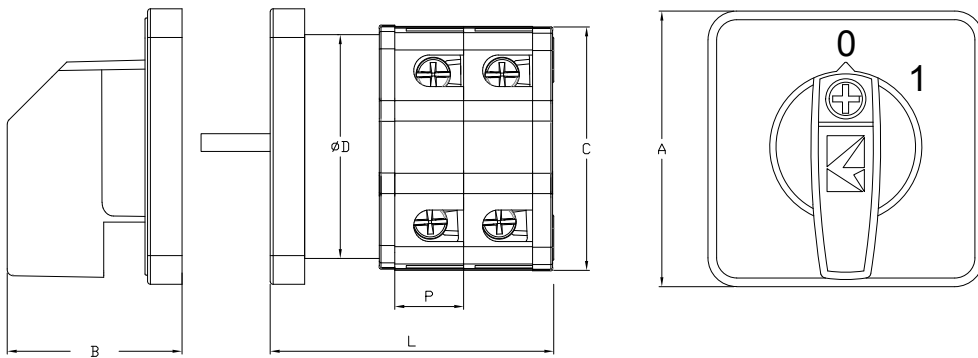

	A	B	C	D
PSA10	48	30,5	42,5	27
PSA16	48	30,5	42,5	27
PSA20	48	30,5	42,5	27
PSA25	48	30,5	42,5	27
PSA32	64	38	55	55
PSA40	64	38	55	55
PSA50	64	38	55	55
PSA63	64	38	55	55
PSA80	85	43	75	75
PSA120	95	43	85	85

## Quick Installation

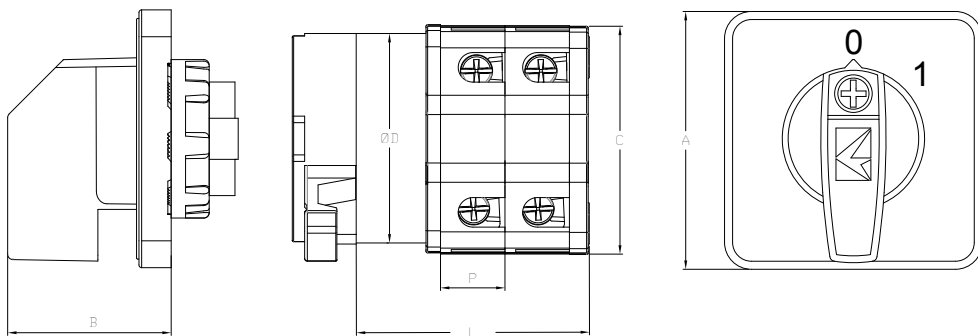

	A	B	C	D
PSA10	48	31	42,5	27
PSA16	48	31	42,5	27
PSA20	48	31	42,5	27
PSA25	48	31	42,5	27
PSA32	64	40	55	55
PSA40	64	40	55	55
PSA50	64	40	55	55
PSA63	64	40	55	55
PSA80	85	45	75	75
PSA120	95	45	85	85

## Dimensions

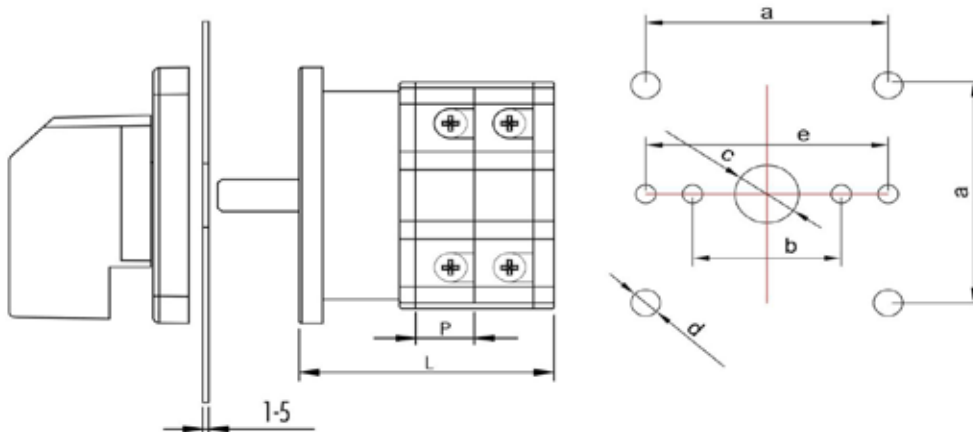

	P	L							
		1	2	3	4	5	6	7	8
PSA10	10	33,2	43,2	53,2	63,2	73,2	83,2	93,2	103,2
PSA16	10	33,2	43,2	53,2	63,2	73,2	83,2	93,2	103,2
PSA20	10	33,2	43,2	53,2	63,2	73,2	83,2	93,2	103,2
PSA25	12	35,2	47,2	59,2	71,2	83,2	95,2	107,2	119,2
PSA32	13	39,2	52,2	65,2	78,2	91,2	104,2	117,2	130,2
PSA40	15	41,2	56,2	71,2	86,2	101,2	116,2	131,2	146,2
PSA50	17,5	43,7	61,2	78,7	96,2	113,7	131,2	148,7	166,2
PSA63	21	47,2	68,2	89,2	110,2	131,2	152,2	173,2	194,2
PSA80	26	63	89	115	141	167	193	219	245
PSA120	30	63	93	123	153	183	213	243	273

	A	B	E	C	D
PSA10	36	30		9,5	4,3
PSA16	36	30		9,5	4,3
PSA20	36	30		9,5	4,3
PSA25	36	30		9,5	4,3
PSA32	48	30	50	10	4,3
PSA40	48	30	50	10	4,3
PSA50	48	30	50	10	4,3
PSA63	48	30	50	10	4,3
PSA80	68	38	50	13	5,2
PSA120	68	38	50	13	5,2

## Cam Switches Selection Table

Series	Terminal Type	Amps	Type	Pole	Angle	Label	Option
<b>PS</b>	<b>A</b>	<b>010</b>	<b>AK</b>	<b>1</b>	<b>3</b>	<b>1</b>	<b>S</b>

<b>PS</b> Cam Switches	<b>A</b> Screw <b>B</b> Terminal <b>C</b> Spring Clamp	<b>010</b> 10 Amp <b>016</b> 16 Amp <b>020</b> 20 Amp <b>025</b> 25 Amp <b>032</b> 32 Amp <b>040</b> 40 Amp <b>050</b> 50 Amp <b>063</b> 63 Amp <b>080</b> 80 Amp <b>120</b> 120 Amp <b>160</b> 160 Amp <b>200</b> 200 Amp	<b>AK</b> On-Off <b>KD</b> Changeover <b>KS</b> Step <b>KT</b> Multi Step <b>MS</b> Motor Control <b>CD</b> Double Speed Switch <b>OK</b> Measuring switch (Voltmeter-Ampermeter) <b>Z*</b> Special Cam Switch	<b>For AK KT MS CD and KD Switches</b> <b>1</b> 1 Pole <b>2</b> 2 Pole <b>3</b> 3 Pole <b>4</b> 4 Pole  <b>For KS and KT Switches</b> <b>2</b> 2 Step <b>3</b> 3 Step <b>4</b> 4 Step <b>5</b> 5 Step <b>6</b> 6 Step <b>7</b> 7 Step <b>8</b> 8 Step <b>9</b> 9 Step  <b>For Z Switches</b> <b> </b> No	<b>1</b> 30° Angle <b>2</b> 45° Angle <b>3</b> 60° Angle <b>4</b> 90° Angle <b>5</b> 90° Angle (Spring Return)	<b>S</b> 48x48 Normal <b>E</b> 48x48 Emergency Yellow Red <b>B</b> 64x64 Normal <b>F</b> 64x64 Emergency <b>AQ</b> Key Operated Quick Installation <b>K</b> Lockable Handle <b>G</b> 48x48 Emergency Grey-Black <b>Q</b> Quick Installation 48x48 Normal <b>P</b> Quick Installation 48x48 Emergency Yellow-Red	<b>1</b> 0 1 <b>2</b> 0 1 2 <b>3</b> 1 2 <b>4</b> 1 0 2  <b>Step Switches</b> <b>2</b> 0 1 2 <b>3</b> 0 1 2 3 <b>4</b> 0 1 2 3 4 <b>5</b> 0 1 2 3 4 5 <b>6</b> 0 1 2 3 4 5 6 <b>7</b> 0 1 2 3 4 5 6 7 <b>8</b> 0 1 2 3 4 5 6 7 8 <b>9</b> 0 1 2 3 4 5 6 7 8 9  <b>Motor Control Switches</b> <b>4</b> 1 0 2 <b>5</b> 0 Y U  <b>Measuring Cam Switches</b> <b>1</b> 0 R-N S-N T-N <b>2</b> 0 R-S S-T R-T <b>6</b> 0 1 2 3 <b>4</b> R-T S-T R-S 0 R-N S-N T-N  <b>Special Rotary Cam Switches</b> <b> </b> Special Label
------------------------	--	---	---	---	--	---	--

**Example:** PSA032AK131B → PSA Series, 32 A, 1 pole, 60 degrees Rotational, 0-1 on-off Cam switch has been selected.

SPECIAL ORDER FORM																																																																																																																																																																																																																																																																	
Rated Voltage	V	Type of Switch	PS	Mounting Form		Diagram No.																																																																																																																																																																																																																																																											
Rated Current	A	Utilization Category				Special Version																																																																																																																																																																																																																																																											
Connection Diagram			<p>Connection Diagram</p>    <table border="1" style="width: 100%; border-collapse: collapse; text-align: center;"> <tr> <td>1</td><td>4</td><td>5</td><td>8</td><td>9</td><td>12</td><td>13</td><td>16</td><td>17</td><td>20</td><td>21</td><td>24</td><td>25</td><td>28</td><td>29</td><td>32</td><td>33</td><td>36</td><td>37</td><td>40</td><td>41</td><td>44</td><td>45</td><td>48</td> </tr> <tr> <td colspan="24"> </td> </tr> <tr> <td>2</td><td>3</td><td>6</td><td>7</td><td>10</td><td>11</td><td>14</td><td>15</td><td>18</td><td>19</td><td>22</td><td>23</td><td>26</td><td>27</td><td>30</td><td>31</td><td>34</td><td>35</td><td>38</td><td>39</td><td>42</td><td>43</td><td>46</td><td>47</td> </tr> </table>					1	4	5	8	9	12	13	16	17	20	21	24	25	28	29	32	33	36	37	40	41	44	45	48																									2	3	6	7	10	11	14	15	18	19	22	23	26	27	30	31	34	35	38	39	42	43	46	47																																																																																																																																																																																		
	1	4						5	8	9	12	13	16	17	20	21	24	25	28	29	32	33	36	37	40	41	44	45	48																																																																																																																																																																																																																																				
2	3	6	7	10	11	14	15	18	19	22	23	26	27	30	31	34	35	38	39	42	43	46	47																																																																																																																																																																																																																																										
Arrangement Of Position Marks On Front Plate	<table border="1" style="width: 100%; border-collapse: collapse; height: 150px;"> <tr><td> </td><td> </td><td> </td><td> </td><td> </td><td> </td><td> </td><td> </td><td> </td><td> </td><td> </td><td> </td><td> </td><td> </td><td> </td><td> </td><td> </td><td> </td><td> </td><td> </td><td> </td><td> </td><td> </td><td> </td><td> </td></tr> <tr><td> </td><td> </td><td> </td><td> </td><td> </td><td> </td><td> </td><td> </td><td> </td><td> </td><td> </td><td> </td><td> </td><td> </td><td> </td><td> </td><td> </td><td> </td><td> </td><td> </td><td> </td><td> </td><td> </td><td> </td><td> </td></tr> <tr><td> </td><td> </td><td> </td><td> </td><td> </td><td> </td><td> </td><td> </td><td> </td><td> </td><td> </td><td> </td><td> </td><td> </td><td> </td><td> </td><td> </td><td> </td><td> </td><td> </td><td> </td><td> </td><td> </td><td> </td><td> </td></tr> <tr><td> </td><td> </td><td> </td><td> </td><td> </td><td> </td><td> </td><td> </td><td> </td><td> </td><td> </td><td> </td><td> </td><td> </td><td> </td><td> </td><td> </td><td> </td><td> </td><td> </td><td> </td><td> </td><td> </td><td> </td><td> </td></tr> <tr><td> </td><td> </td><td> </td><td> </td><td> </td><td> </td><td> </td><td> </td><td> </td><td> </td><td> </td><td> </td><td> </td><td> </td><td> </td><td> </td><td> </td><td> </td><td> </td><td> </td><td> </td><td> </td><td> </td><td> </td><td> </td></tr> <tr><td> </td><td> </td><td> </td><td> </td><td> </td><td> </td><td> </td><td> </td><td> </td><td> </td><td> </td><td> </td><td> </td><td> </td><td> </td><td> </td><td> </td><td> </td><td> </td><td> </td><td> </td><td> </td><td> </td><td> </td><td> </td></tr> <tr><td> </td><td> </td><td> </td><td> </td><td> </td><td> </td><td> </td><td> </td><td> </td><td> </td><td> </td><td> </td><td> </td><td> </td><td> </td><td> </td><td> </td><td> </td><td> </td><td> </td><td> </td><td> </td><td> </td><td> </td><td> </td></tr> <tr><td> </td><td> </td><td> </td><td> </td><td> </td><td> </td><td> </td><td> </td><td> </td><td> </td><td> </td><td> </td><td> </td><td> </td><td> </td><td> </td><td> </td><td> </td><td> </td><td> </td><td> </td><td> </td><td> </td><td> </td><td> </td></tr> <tr><td> </td><td> </td><td> </td><td> </td><td> </td><td> </td><td> </td><td> </td><td> </td><td> </td><td> </td><td> </td><td> </td><td> </td><td> </td><td> </td><td> </td><td> </td><td> </td><td> </td><td> </td><td> </td><td> </td><td> </td><td> </td></tr> <tr><td> </td><td> </td><td> </td><td> </td><td> </td><td> </td><td> </td><td> </td><td> </td><td> </td><td> </td><td> </td><td> </td><td> </td><td> </td><td> </td><td> </td><td> </td><td> </td><td> </td><td> </td><td> </td><td> </td><td> </td><td> </td></tr> </table>																																																																																																																																																																																																																																																																
<p>Note:</p>     																																																																																																																																																																																																																																																																	
<p>Company Name _____</p> <p>Address _____</p> <p>_____</p> <p>Telephone _____ Fax _____ Data _____</p>																																																																																																																																																																																																																																																																	

## Industrial Type Plug & Sockets Selection Table

Series	Body Material	Number Of Contacts	Type	Entry	Locking	Features
<b>EB</b>	<b>M</b>	<b>10</b>	<b>FM</b>	<b>4</b>	<b>4</b>	<b>H</b>
<b>EB</b> EB Series Industrial Type Plugs & Sockets	<b>B</b> Body Material <b>M</b> Metal <b>P</b> Plastic <b>O</b> Insert	<b>N</b> Number Of Contacts <b>4</b> 4 Poles (10 Amp) <b>5</b> 5 Poles (10 Amp) <b>6</b> 6 Poles (16 Amp) <b>10</b> 10 Poles (16 Amp) <b>16</b> 16 Poles (16 Amp) <b>24</b> 24 Poles (16 Amp) <b>32</b> 32 Poles (16 Amp) <b>48</b> 48 Poles (16 Amp) <b>606</b> 6 Poles (35 Amp) <b>612</b> 12 Poles (35 Amp) <b>806</b> 4x80 Amp, 2x16 Amp <b>812</b> 8x80 Amp, 4x16 Amp	<b>T</b> Type <b>FU</b> Hood With Male Insert <b>FM</b> Housing With Male Insert <b>FD</b> Housing With Male Insert (Surface Mounting) <b>PU</b> Hood With Female Insert <b>PM</b> Housing With Female Insert <b>PD</b> Housing With Female Insert (Surface Mounting) <b>PE</b> Female Insert (Sloping) <b>CF</b> Male Insert <b>CP</b> Female Insert <b>GU</b> Hood Only <b>GM</b> Housing <b>GD</b> Housing (Surface Mounting) <b>GE</b> Housing (Sloping) <b>XU</b> Plug Spring Clamped Extension <b>XM</b> Plug Spring Clamped Machine <b>XD</b> Plug Spring Clamped Surface <b>ZU</b> Socket Spring Clamped Extension <b>ZM</b> Socket Spring Clamped Machine <b>ZD</b> Socket Spring Clamped Surface <b>ZE</b> Socket Spring Clamped Sloping <b>CF</b> Male Insert <b>CP</b> Female Insert <b>CX</b> Male Insert Spring Clamped <b>CZ</b> Female Insert Spring Clamped	<b>L</b> Locking <b>0</b> Without <b>1</b> One Handle <b>2</b> Two Handle Roller <b>4</b> Four Handle Roller <b>6</b> Metal Opening (Single Arm) <b>7</b> Metal Handle <b>8</b> Metal Opening (Double Arm)	<b>E</b> Entry <b>0</b> Non Entry <b>1</b> Side Entry <b>2</b> Double Side Entry <b>3</b> Top Entry <b>4</b> Bottom Entry <b>5</b> Bottom & Side Entry	<b>F</b> Features <b>H</b> Black <b>PG21</b> PG21 Entry <b>PG29</b> PG29 Entry

## IF Series Multi Colour Beacons Selection Table

Series	Diameter	Type	Voltage	Buzzer	Connection	Cable Length
<b>IF</b>	<b>5</b>	<b>M</b>	<b>024</b>	<b>X</b>	<b>M03</b>	<b>-1</b>
<b>IF</b> Series Multi Colour Beacons	<b>5</b> Ø55 mm Diameter <b>6</b> Ø65 mm Diameter	<b>M</b> Multifunction <b>P</b> PLC in sync <b>R</b> Red <b>Y</b> Yellow <b>G</b> Green <b>W</b> White <b>B</b> Blue <b>T</b> 3 colours	<b>012</b> 012V AC/DC <b>024</b> 024V AC/DC <b>110</b> 110V AC <b>220</b> 220V AC	<b>X</b> w/o Buzzer <b>W</b> Buzzer with Sensitive to Sound <b>Z</b> With Buzzer <b>XR</b> w/o Buzzer Rotational <b>ZR</b> With Buzzer Rotational  W Valid Only for IF6 Series Z-XR-ZR Valid Only for IF5 Series	<b>M01</b> 100mm Plastic Base <b>M02</b> 20mm Aluminium Base <b>M03</b> 100mm Aluminium Base <b>M04</b> 500mm Aluminium Base <b>D01</b> Wall Base <b>D02</b> Adjustable Base <b>D40</b> Wall Base, Mounting with Tube, Side Entry <b>D41</b> Wall Base, Mounting with Tube, Bottom Entry (Cable Gland) <b>D50</b> Wall Connection with Base, Side Entry <b>D51</b> Wall Connection with Base, Bottom Entry (Cable Gland)	<b>-0.6</b> 0.6 Metre Cable <b>-1</b> 1 Metre Cable <b>-2</b> 2 Metre Cable <b>-3</b> 3 Metre Cable <b>-5</b> 5 Metre Cable <b>X</b>



## IT Series Multifunctional Beacon Selection Table

Series	Diameter	Colour	Voltage	Type
<b>IT</b>	<b>120</b>	<b>Y</b>	<b>024</b>	<b>L</b>
<b>IT</b> Series Multifunctional Beacon	<b>120</b> Ø120 mm Diameter	<b>R</b> Red <b>Y</b> Yellow <b>G</b> Green <b>B</b> Blue	<b>024</b> 024V AC/DC <b>48</b> 48V AC <b>110</b> 110V AC <b>220</b> 220V AC	<b>L</b> with LED <b>Z</b> with LED&Buzzer

A series of horizontal dotted lines spanning the width of the page, intended for handwritten notes.









EMAS ELEKTROTEKNİK MAKİNA SANAYİ ve TİCARET A.Ş.  
İkitelli Organize Sanayi Bölgesi Mah.  
Atatürk Bulvarı No:50/A 34490 Başakşehir - İSTANBUL / TÜRKİYE  
Tel: +90 212 549 2252 Faks: +90 212 549 2580  
info@emasas.com.tr



emasas.com.tr

EMASAS LIMITED  
G10 Schott House, Drummond Rd, Stafford ST16 3EL  
UNITED KINGDOM (+44) 01785 747 620

info@emas.uk.com



emas.uk.com





## X-ON Electronics

Largest Supplier of Electrical and Electronic Components

*Click to view similar products for [Audio Indicators & Alerts](#) category:*

*Click to view products by [EMAS](#) manufacturer:*

Other Similar products are found below :

[M2BJ-BH24E](#) [6-4](#) [68S1240-PA](#) [MBA-624](#) [F/BC 40P-DR LF](#) [FDG111PLF](#) [F/NRMB 24 BLACK LF](#) [PF-35N29WQ](#) [PFD-27A35PQ](#) [PL-27A35PSQ](#) [PS-531Q](#) [AB2020B-2-LW1](#) [EBPT-401](#) [PB06SD12AP](#) [PB-1220PEQ](#) [S6109](#) [SC2036ACP](#) [SC616N-2](#) [SC628FW](#) [SC628MPG](#) [SC648D](#) [SCS045MD9DT3S](#) [AB2025B-LW50-R](#) [ESZ-25B-5-250B](#) [F/BC 35-DR LF](#) [FCM12PLF](#) [F/EB20P-DR LF](#) [F/HU110MP24V-IP67B LF](#) [AI-2835-TF-LW150-2-R](#) [AI-4228-TF-LW305-R](#) [FSMD8585JSLF](#) [FSS-26T](#) [F/SU 21-02 LF](#) [F/TCW 05 WITH LABEL LF](#) [F/UCW 03 WITH LABEL LF](#) [F/UCW 06 WITH LABEL LF](#) [PKM22EPPH40S1-B0](#) [PKM35-4A0](#) [PL-35N29WQ](#) [PLD-27A35PQ](#) [PS-552Q](#) [CM-5](#) [M2BJ-BH24E-D](#) [REF-202](#) [LSC628ANR](#) [5-100](#) [PAL-328](#) [03-810.001](#) [RTO-1R07-001](#) [PL-21N31PQ](#) [PF-27A25PSQ](#)