

User Manual

Grid-EYE Evaluation Kit

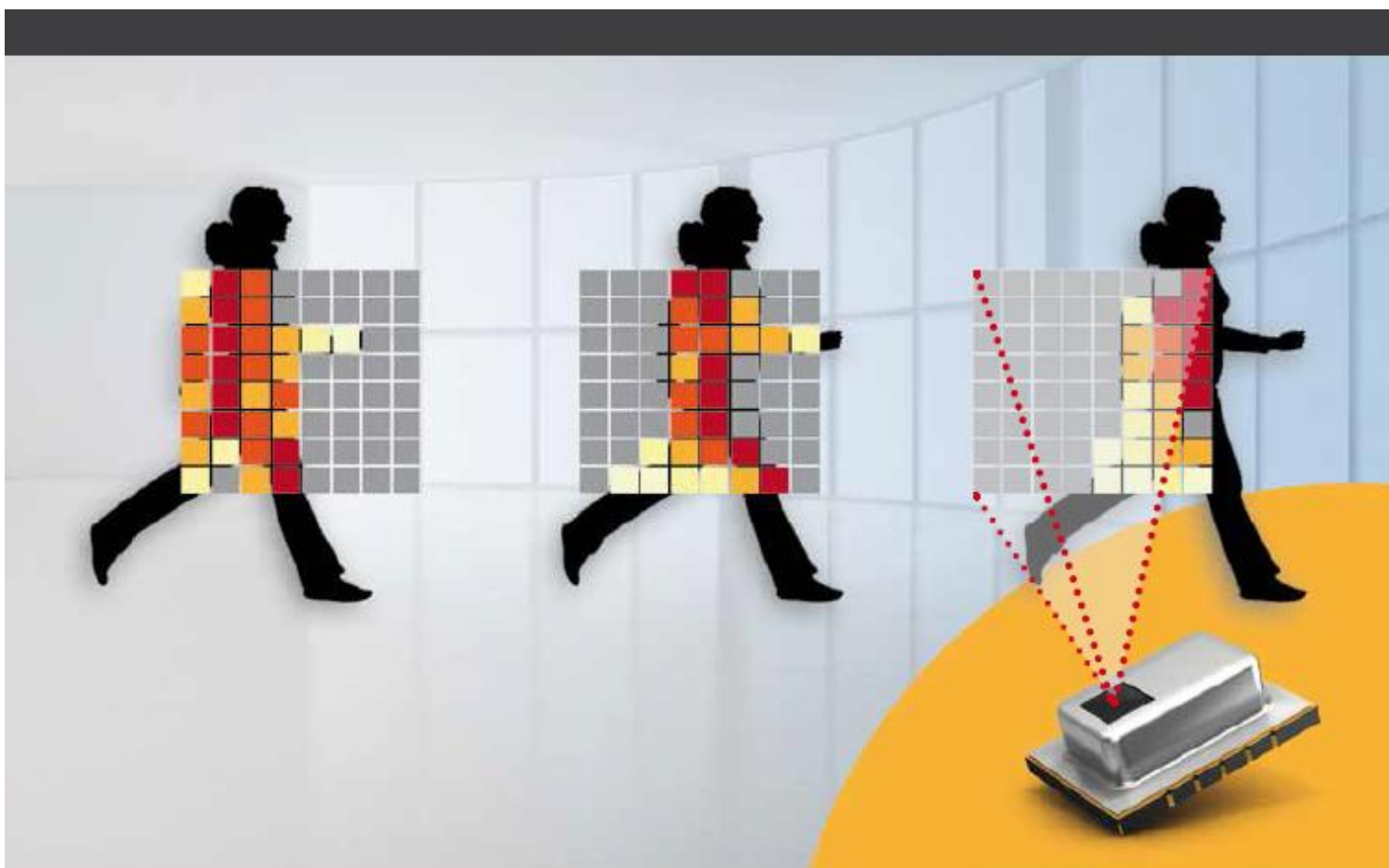

Content

1	Terms & Abbreviations.....	3
2	Introduction.....	4
2.1	Product Introduction.....	4
2.2	Evaluation Kit Component Details.....	5
2.2.1	Grid-EYE Sensor.....	6
2.2.2	ATSAMD21- SMART ARM-Based Microcontroller	7
2.2.3	Bluetooth Module PAN1740.....	8
3	Interface Definition.....	9
3.1	Download & Debug	9
3.1.1	USB interface pin definition (J16)	9
3.1.2	Serial Wire Debug interface Header definition (J17)	10
3.1.3	Serial Wire Debug port for PAN1740 Header definition (J1)	10
3.1.4	Arduino Interfaces (J2, J3, J4 and J5)	11
3.1.5	Arduino Analog I/O A0-A5 pin definitions (J2).....	12
3.1.6	Arduino Digital I/O D0-D7 pin definition (J3)	12
3.1.7	Arduino Power port pin definition (J4)	13
3.1.8	Arduino Digital I/O D8-D15 pin definition (J5)	13
3.1.9	Other Jumpers Definition.....	14
4	Development with Evaluation Kit.....	15
4.1	Firmware architecture	15
4.1.1	Independent Mode	15
4.1.2	Arduino Mode	17
4.2	Firmware development.....	19
4.2.1	Development Tools	19
4.2.2	Development on ATSAMD21	20
4.2.3	Development with Grid-EYE APIs.....	21

4.2.4	Development on Arduino.....	22
4.2.5	Development on PAN1740.....	25
4.3	Updating firmware	28
4.3.1	Use USB interface to update ATSAMD21G18A.....	28
4.3.2	Use Serial interface to update PAN1740.....	30
5	Grid-EYE Demonstration Software for PC.....	35
5.1	Preparation.....	35
5.1.1	Jumper Setting	35
5.2	Demonstration.....	36
5.2.1	Independent Mode Demonstration	36
5.2.2	Arduino Mode Demonstration.....	40
6	Appendix	43
6.1	Install USB Driver for ATSAMD21G18A	43
7	ESD precautions and proper handling procedures	46
8	Compliance Information.....	47

1 Terms & Abbreviations

The following terms & abbreviations will be referenced in this document:

Term / Abbreviation	Definition
BT	Bluetooth (refers to PAN1740)
CDC	Communications Device Class
HW	Hardware
I2C / IIC / I ² C	Inter-Integrated-Circuit
I/O	Input / Output
IoT	Internet of Things
IR	Infrared
JTAG	Joint Test Action Group
MCU	Microcontroller
PC	Personal Computer
SW	Software
SWD	Serial Wire Debug
UART	Universal Asynchronous Receive Transmit
USB	Universal Serial Bus

2 Introduction

This user manual is aimed at giving the customers an overview of the latest evaluation kit for Grid-EYE sensor released by Panasonic. The following picture shows how your evaluation kit should look like when you take it out of the box.

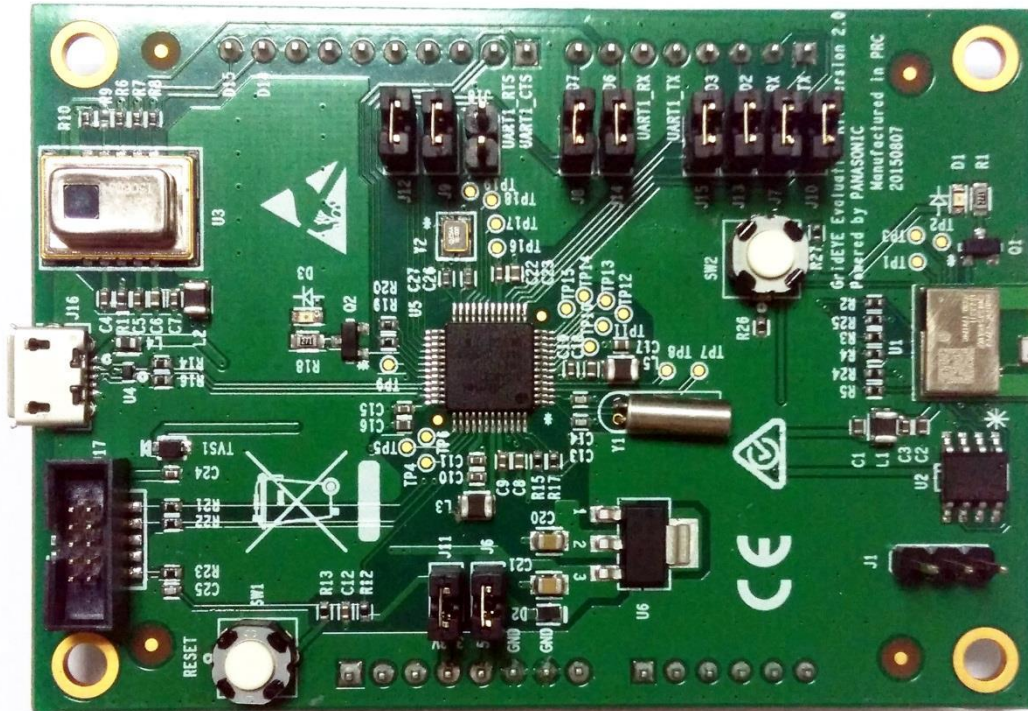

2.1 Product Introduction

Grid-EYE Infrared (IR) Array sensor Evaluation Kit combines the Panasonic's state of the art Grid-EYE sensor, Panasonic "nanopower" PAN1740 Bluetooth Smart module and a microcontroller on one PCB. By combining its new IR sensor technology with Bluetooth technology and software for IR detection of people and objects on one board, Panasonic enables customers to develop rapid prototypes and quickly build their own wireless sensor "Internet of Things" applications.

To make it simpler and easier for the user, Panasonic has been flexible in the development of this evaluation kit. The board functions in a standalone mode or it can be connected to an Arduino host board if the user wants to realize the functionality of the sensor with more than the provided interfaces. The two operating modes of the evaluation kit are explained below:

1) Independent mode

The onboard microcontroller ATSAM21G18 receives the infrared image data sampled by Grid-EYE sensor through the I²C interface, and then sends this data to a PC and smartphone via USB and Bluetooth, respectively.

2) Arduino mode

Arduino mother board receives the data sampled by Grid-EYE sensor through the I²C interface and then sends the data to a PC and smartphone via USB and Bluetooth, respectively. In this mode the microcontroller, ATSAM21G18, acts as USB CDC device and provides a communication channel between Arduino mother board and PC.

In both of the two modes, the Bluetooth module provides a communication channel between the microcontroller or the Arduino mother board, and smartphone.

2.2 Evaluation Kit Component Details

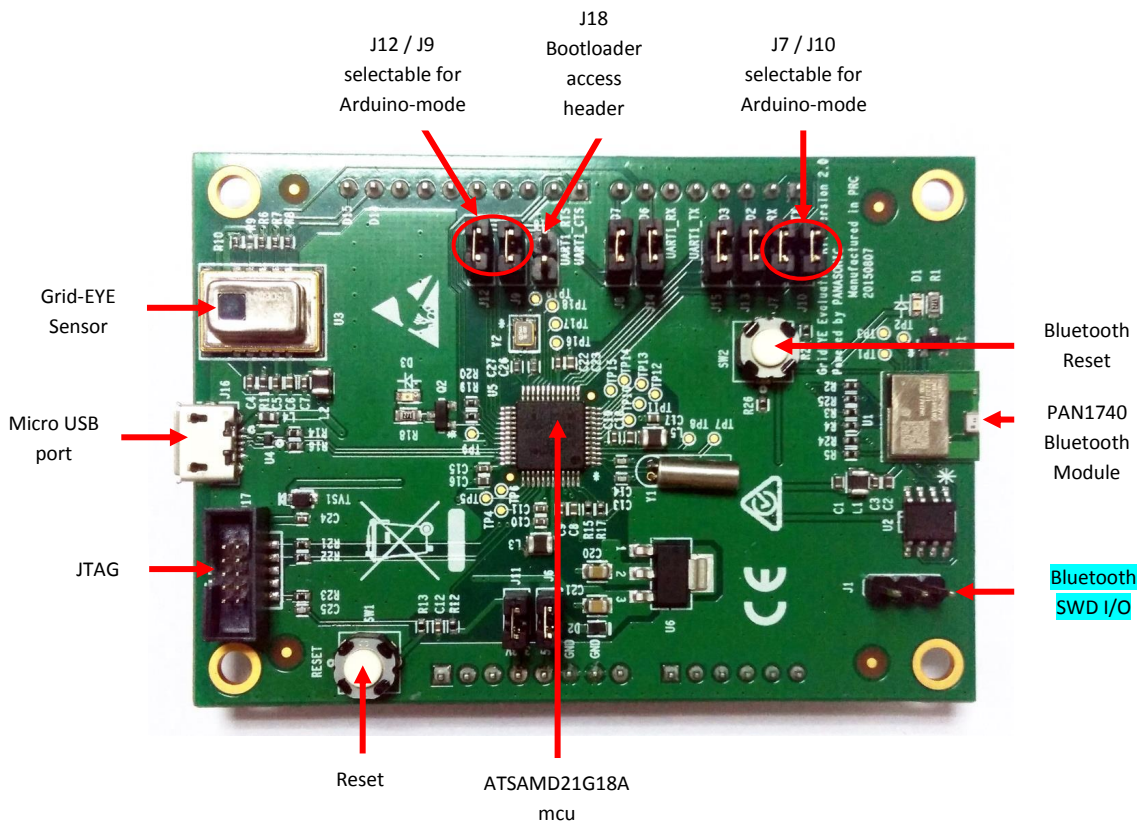



WARNING

- The jumper shunt for the pin-header designated J18 must not be placed on the pin-header prior to using the board, unless the intent is to access the Bootloader.
- The Grid-EYE board has Arduino headers soldered on for convenience, should the user choose to host the board onto an Arduino (DUE) mother board. Users are reminded to be careful so not short-out the pins or have the board resting on a conductive surface.

2.2.1 Grid-EYE Sensor

Specification	Value
Power voltage	3.3V \pm 10%, 5V \pm 10%/
Current consumption	4.5mA (normal), 0.8mA (standby), 0.2mA (sleep)
View angle	60 degrees (x,y)
Absolute temperature accuracy	High gain: \pm 2.5°C (typ.) Low gain: \pm 3.0°C (typ.)
Noise Equivalent Temperature Difference	0.5°C @ 10Hz
Frame rate (selectable):	1 frame/sec or 10 frames/sec
External interface	I ² C (12bit)
Operation mode	Normal, Standby, Sleep (Selectable)
Number of Pixel	64 - (Vertical 8 x Horizontal 8 Matrix)

Grid-EYE Sensor options:

Whilst the Evaluation Kit hosts and demonstrates capabilities of the 3.3V, Low Gain device, the user has the following options available for design-in and application:

- 3.3V high gain
- 3.3V low gain
- 5V high gain
- 5V low gain

Item	Performance	
	High Gain	Low Gain
Applied Voltage	3.3V +/- 0.3V or 5.0V +/- 0.5V	
Detection temperature range	+32°F to 176°F (0°C to +80°C)	-4°F to 212°F (-20°C to +100°C)
Temperature range of measured object	+32°F to 176°F (0°C to +80°C)	-4°F to 212°F (-20°C to +100°C)
Operating temperature range	+32°F to 176°F (0°C to +80°C)	-4°F to 176°F (-20°C to +80°C)
Storage temperature range	-4°F to 176°F (-20°C to +80°C)	-4°F to 176°F (-20°C to +80°C)

Part Numbers:

Product Name	Operating Voltage	Amplification factor	Part Number
Infrared array sensor Grid-EYE	3.3V DC	High Gain	AMG8831
		Low Gain	AMG8832
	5.0V DC	High Gain	AMG8851
		Low Gain	AMG8852

The sensors are packaged in a 8mm x 11.6mm x 4.3mm SMD reflow mountable 'can' package. The packaging of the sensor is moisture proof, comparable to MSL level 3.

2.2.2 ATSAMD21- SMART ARM-Based Microcontroller

The Atmel® SMART™ SAM D21 is a series of low-power microcontrollers using the 32-bit ARM® Cortex®-M0+ processor, with identical peripheral modules, hex compatible code, identical linear address map and pin compatible paths between all devices in the product series. All devices include intelligent and flexible peripherals, Atmel Event System for inter-peripheral signaling, and support for capacitive touch button, slider and wheel user interfaces. The Grid-EYE sensor board hosts the ATSAMD21G18A variant in a 48-pin QFN package, ideal for a wide range of home automation, consumer, metering, and industrial

applications and supported by Atmel Studio, the Atmel Software Framework and SAMD21 Xplained kits. Basic specifications of the MCU are shown below:

Item	Description
CPU Core	Cortex-M0+
Max. CPU frequency	48MHz
ROM	256K
RAM	32K
USB	Full-speed USB 2.0 (Support USB Host and USB device)
I ² C	Up to 3.4MHz
UART	Up to 3.4MHz
Power Supply	1.62V to 3.63V

More details are available from:

http://www.atmel.com/Images/Atmel-42181-SAM-D21_Datasheet.pdf

2.2.3 Bluetooth Module PAN1740

The PAN1740 is a short-range BLE single mode module compliant with the Bluetooth V4.0 standard. It includes dedicated hardware for the Link Layer implementation of Bluetooth® Smart and interface controllers for enhanced connectivity capabilities. Due to its high performance, Panasonic chose to use this for the evaluation kit. Basic specifications of this BT module can be seen below.

Item	Description
CPU Core	Cortex-M0
CPU frequency	16MHz or 32.768KHz
Power Consumption	Max power consumption: 4.9mA (TX and RX).
Bluetooth	Embedded BLE Stack and GATT Profile, qualified to the Bluetooth 4.0 standard
Operating Temperature	-40°C to 85°C
Gain	93dBm

More details on this BT module can be found on the following link:

<https://pideu.panasonic.de/products/wireless-modules/bluetooth/bluetooth-40-low-energy-single-mode/PAN1740-Bluetooth-Ultra-Low-Energy-Module.html>

3 Interface Definition

This section of the manual will explain about the onboard USB interface, software debug interface, and pin definitions for J1 - J8.

3.1 Download & Debug

Below you can see the definition of different headers and interfaces on the evaluation kit.

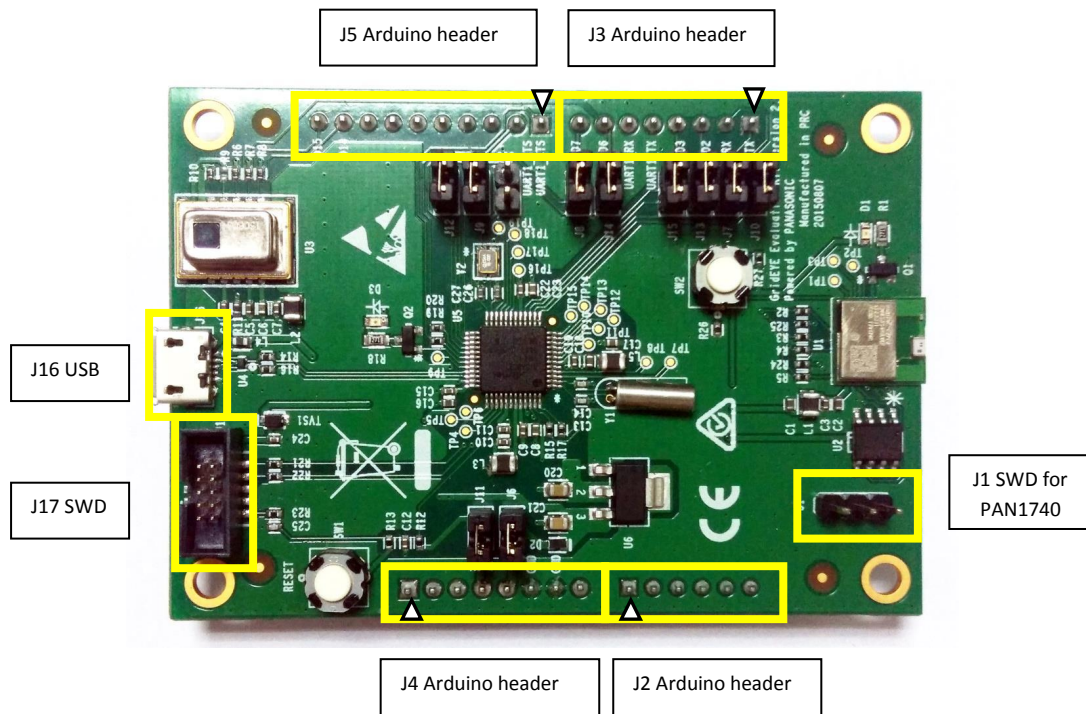

3.1.1 USB interface pin definition (J16)

The Micro USB interface on the evaluation kit is used for power supply and communication with the external PC. The definition of USB pins is defined below in the table:

Pin Number	Signal	Function
1	VBUS	+5V
2	DM	USB Data-
3	DP	USB Data+
4	ID	USB ID
5	GND	GND

3.1.2 Serial Wire Debug interface Header definition (J17)

Serial Wire Debug (SWD) is compatible with all ARM processors and any processor using JTAG for debugging. It provides a debug port for pin limited packages. It replaces the 5-pin JTAG port with a clock + single bi-directional data pin, SWDIO and SWCLK, providing all the normal JTAG debug and test functionality.

Standard 10-pin JTAG Debug & Download Interface are shown below in the table:

Pin Number	Signal	Function
1	VDD3.3	+3.3V
2	SWDIO	SW debug data signal for ATSAMD21
3	GND	GND
4	SWCLK	SW debug clock signal for ATSAMD21
5	GND	GND
6	NC	NC
7	GND	GND
8	NC	NC
9	GND	GND
10	RESET	Reset ATSAMD21 MCU

GND = Ground

NC = Not Connected

3.1.3 Serial Wire Debug port for PAN1740 Header definition (J1)

Standard 10-pin JTAG Debug & Download Interface are shown below in the table:

Pin Number	Signal	Function
1	DIO	SW debug data signal for PAN1740
2	P1_4/SWCLK	SW debug clock signal for PAN1740
3	OTP	One time programming selecting pin for PAN1740

3.1.4 Arduino Interfaces (J2, J3, J4 and J5)

The following schematics define the pins for each header on the evaluation kit.

Schematics:

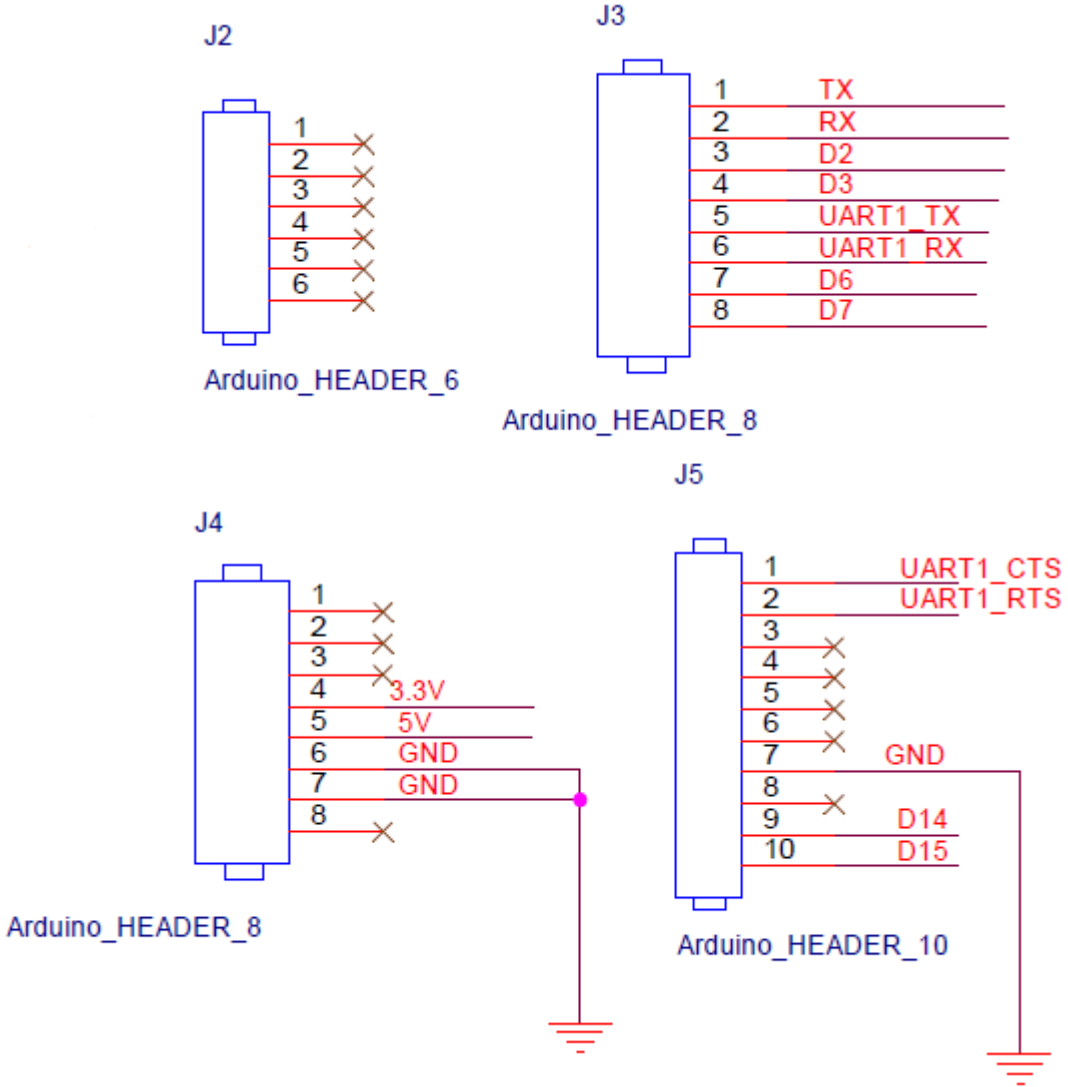

3.1.5 Arduino Analog I/O A0-A5 pin definitions (J2)

On the evaluation kit, analog I/O is not supported. The headers are meant for physical Arduino compatibility only. The table below shows the pin definitions for this header.

Pin Number	Signal	Function
1	NC	NC
2	NC	NC
3	NC	NC
4	NC	NC
5	NC	NC
6	NC	NC

3.1.6 Arduino Digital I/O D0-D7 pin definition (J3)

The following table shows the pin definition of the J3 header.

Pin Number	Signal	Function
1	TX	D0 for Arduino / TX pin for PAN1740 UART
2	RX	D1 for Arduino / RX pin for PAN1740 UART
3	D2	D2 for Arduino
4	D3	D3 for Arduino
5	UART1_TX	D4 for Arduino / TX pin for ATSAMD21 UART1
6	UART1_RX	D5 for Arduino / RX pin for ATSAMD21 UART1
7	D6	D6 for Arduino
8	D7	D7 for Arduino

3.1.7 Arduino Power port pin definition (J4)

The following table shows the pin definition of the J4 header.

Pin Number	Signal	Function
1	NC	NC
2	NC	NC
3	NC	NC
4	3.3V	3.3V voltage input power
5	5V	5V voltage input power
6	GND	GND
7	GND	GND
8	NC	NC

3.1.8 Arduino Digital I/O D8-D15 pin definition (J5)

The following table shows the pin definition of the J5 header.

Pin Number	Signal	Function
1	UART1_CTS	D8 for Arduino
2	UART1_RTS	D9 for Arduino
3	NC	D10 for Arduino
4	NC	D11 for Arduino
5	NC	D12 for Arduino
6	NC	D13 for Arduino
7	GND	GND
8	NC	AREF for Arduino
9	D14	D14 for Arduino / SDA pin for ATSAM21 I ² C
10	D15	D15 for Arduino / SCL pin for ATSAM21 I ² C

3.1.9 Other Jumpers Definition

The following table explains several other headers on the evaluation kit.

Connector	Pin 1	Pin 2	Function
J7	TX	UART_RX	Select to connect RX pin for ATSAMD21 USART1 with D1 for Arduino and TX for PAN1740 UART.
J10	RX	UART_TX	Select to connect RX pin for PAN1740 UART with TX pin for ATSAMD21 UART
J13	D2	UART_CTS	Select to connect D2 for Arduino with CTS pin(hardware flow control) for ATSAMD21 UART
J15	D3	UART_RTS	Select to connect D3 for Arduino with RTS pin(hardware flow control) for ATSAMD21 UART
J9	D14	SCL	Select to connect SCL pin for ATSAMD21 I2C with SCL pin for Grid-EYE sensor.
J12	D15	SDA	Select to connect SDA pin for ATSAMD21 I2C with SDA pin for Grid-EYE sensor.
J8	D7	INT	Select to connect Arduino data pin D7 with Grid-EYE's interrupt signal INT.
J6	5V	D2 negative pole	Select 5V power from Arduino board.
J11	3.3V	VDD3.3	Select 3.3V power from Arduino board.
J14	D6	RESET	Select to connect D6 for Arduino with Reset pin for PAN1740
J18	GND	PA15	Select to connect PA15 for ATSAMD21 to ground.

Jumper settings:

1. J7 and J10 are used to isolate the UART port for the ATSAMD21 microcontroller when programming the Bluetooth module PAN1740, or engage the board into Arduino mode.
2. J9 and J12 are used to set up the evaluation kit into either independent mode or Arduino mode. When J9 and J12 are in-situ, the sensor and ATSAMD21 are connected via I²C and the board works in independent mode. Removing the two jumpers will enable the Arduino mode when the Grid-EYE board is hosted onto the Arduino board. If not hosted onto the Arduino board and jumpers are removed unexpected and undefined data will be received and/or transmitted.
3. When programming ATSAMD21 with SAM-BA, J18 is placed in-situ to update the bootloader or start the application. By having the jumper J18 connected and the reset button SW1 pressed, ATSAMD21 will be ready for updating the bootloader.

4 Development with Evaluation Kit

For a customized firmware development on the evaluation kit, it is important for the developer to know the Firmware architecture of the kit in two different modes. This section explains this in detail.

4.1 Firmware architecture

As explained earlier, there are two modes that the board can be used in. Independent mode, and Arduino mode.

4.1.1 Independent Mode

The following block diagram illustrates the independent mode of operation for the evaluation kit, utilizing the standard communications protocols:

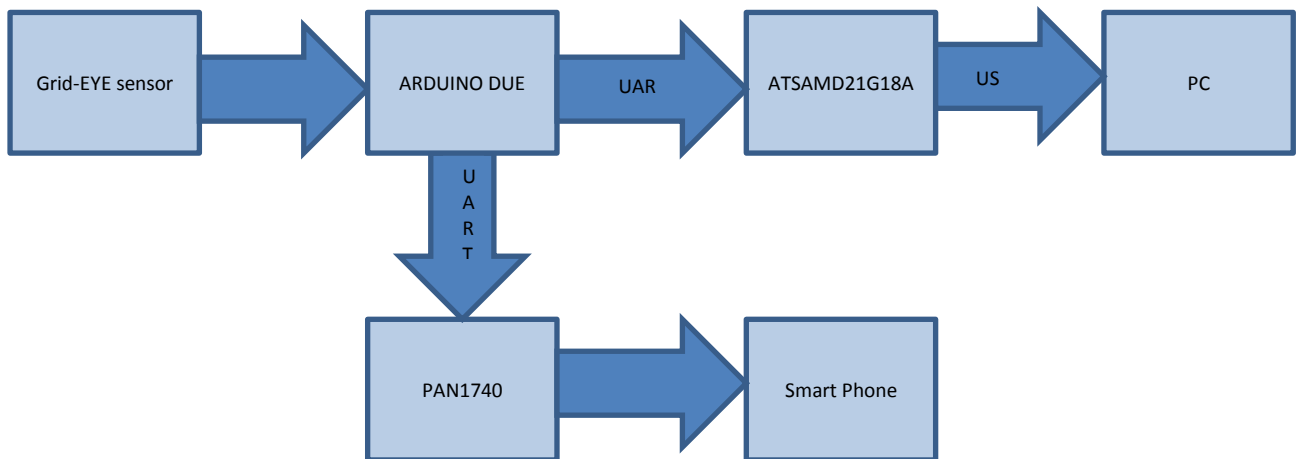

In the independent mode, data sampling and transfer will be executed by the ATSAM21 microcontroller ; the program flow diagram is given below:

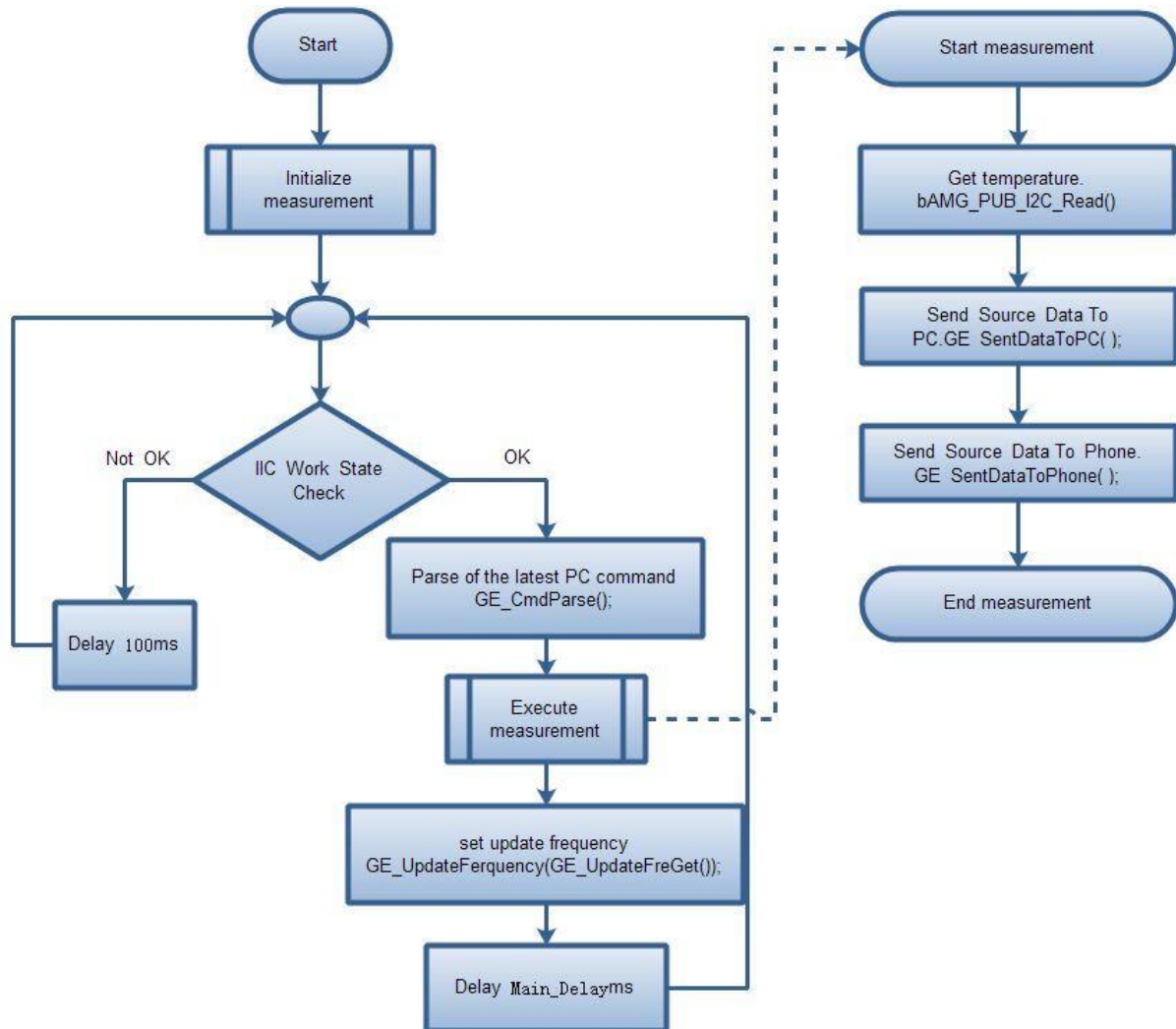

Flow-chart steps explained:

- Decision point - check I²C response of Grid-EYE sensor:
 - If valid, Independent mode is confirmed.
 - If invalid, Arduino mode is confirmed.
- Delay of 100ms is applied for periodic inspection of I²C. This allows the microcontroller to determine mode of operation.
- Parse the command from PC, such as the command of setting the sampling frequency.
- Measurement - read data from the sensor and send it to PC and smartphone.
- Updating frequency - if the sampling frequency is updated, then reset it.
- Delay applied in the loop, determined by the sampling frequency.

4.1.2 Arduino Mode

The following block diagram illustrates Arduino mode of operation for the evaluation kit with standard communication protocols:

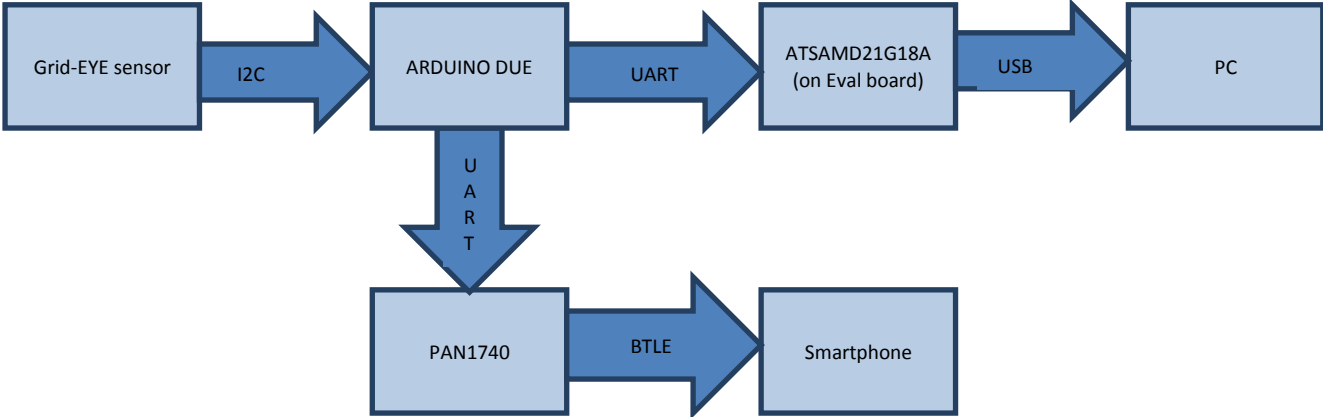

In the Arduino mode, data sampling and transfer will be executed by Arduino mother board; the program flow diagram is shown below:

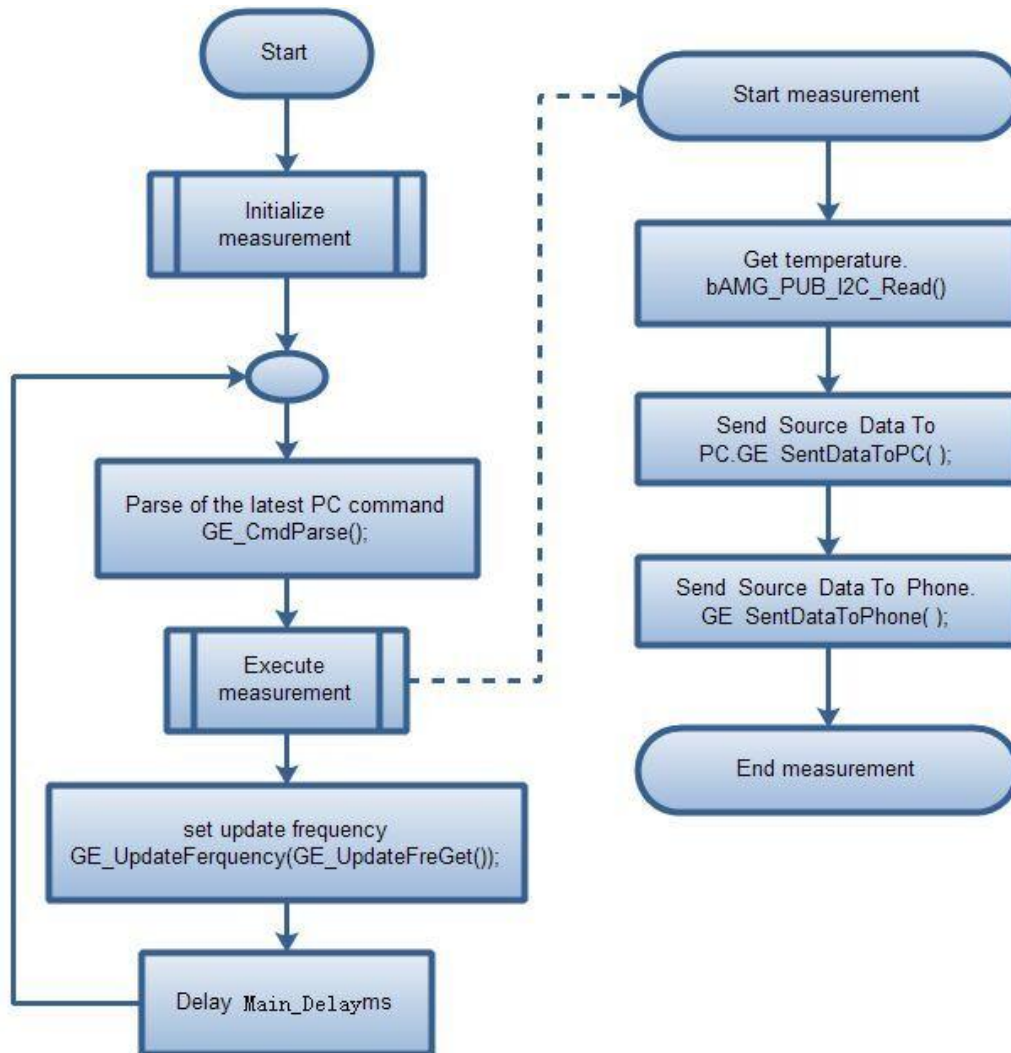

Flow-chart steps explained:

- Parse the command from PC, such as the command of setting the sampling frequency.
- Measurement - Read data from the sensor and send it to PC and smartphone.
- If the sampling frequency is updated, then reset the sampling frequency.
- Delay applied in the loop, determined by the sampling frequency.

4.2 Firmware development

For the two modes of operation, independent and Arduino mode, we will explain separately the development process. We will also give a brief introduction in this section on the programming of the Bluetooth module built on the evaluation kit.

4.2.1 Development Tools

The following tools are needed when developing application for Grid-EYE Sensor board.

Hardware

1. PC with at least 2 USB interface
2. Micro-USB cables
3. TTL Serial to USB module (only to program Bluetooth module PAN 1740)
4. J-Link

Software

Users need to install the following software according to the target they develop:

Software	Description	Download link
Atmel Studio	Develop the code for ATSAM21	http://www.atmel.com/tools/ATMELSTUDIO.aspx
SAM-BA	Program ATSAM21, if JTAG is not available	http://www.atmel.com/tools/ATMELSAM-BAIN-SYSTEMPROGRAMMER.aspx
Arduino IDE	Develop the code for Arduino mother board	https://www.arduino.cc/en/Main/Software
Keil MDK	Develop the code for Bluetooth module	http://www.keil.com/arm/mdk.asp
Smart Snippet	Program Bluetooth module	http://support.dialog-semiconductor.com/product/da14580

4.2.2 Development on ATSAM21

The demonstration software code project for ATSAM21 is created using ATMEL studio. The main function of the code is data acquisition and transmission. Both the operating modes are supported by just one firmware code. So switching between the independent mode and Arduino mode does not need changing the code in ATSAM21. The firmware decides on the mode by the response of the I²C interface.

There are two ways to download the program to ATSAM21:

- If you have a JTAG debugger, like a J-link, you can download the program with IDE or other tools
- But if you don't have J-link and/or you want to download the program through USB interface with SAM-BA, the bootloader must be downloaded into the MCU before downloading application. Thus you need to modify the linker script before building the project to tell the linker how to allocate the address of the bootloader and Application.

Linker script is located in the following path:

SAMD21_USB_DUART_DEMO/src/ASF/sam0/utils/linker_scripts/samd21/gcc/samd21j18a_flash.ld

Modify the files as follows:

```
/* Memory Spaces Definitions */
MEMORY
{
  rom      (rx)  : ORIGIN = 0x00002000, LENGTH = 0x00038000
  ram      (rwx) : ORIGIN = 0x20000000, LENGTH = 0x00008000
}
```

The ORIGIN value needs to be modified to 0x00002000 to leave a space for bootloader.

Constraints in using SAM-BA with USB/UART requires that the bootloader or any access to memory in the ATSAM21 series be made from 0x00002000 onwards.

For more details, refer to: Grid_Eye_Source\Atmel\BOOTLOADER\Atmel-42366-SAM-BA-Bootloader-for-SAM-D21_ApplicationNote_AT07175.pdf

4.2.3 Development with Grid-EYE APIs

For the development with the APIs Atmel studio will be needed. This can be downloaded as mentioned above and the detailed guide can be accessed on Atmel’s official website:

http://www.atmel.com/microsite/atmel_studio6/

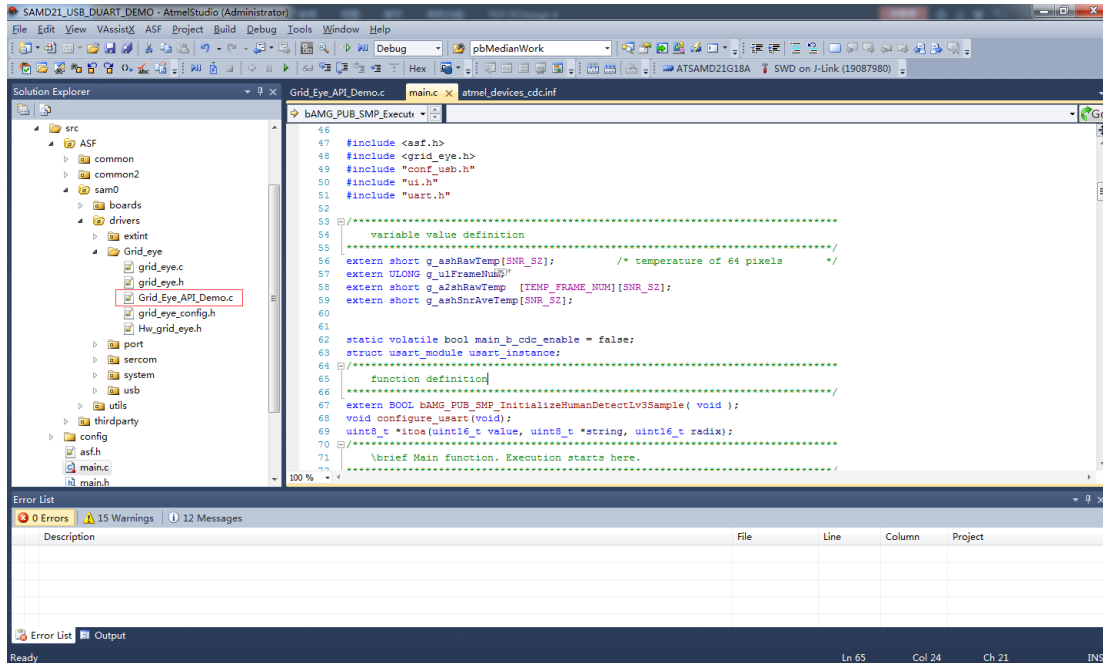

The file “Grid_Eye_API_Demo.c” provides the methods of using Grid-EYE’s 3 layers API. Users can try the object detection and human body detection functions via the serial debug assistant.

4.2.3.1 Introduction to API Lib

Grid-EYE API Lib is divided into 3 layers; users can select API functions from these layers according to the requirement.

- ◆ API Lv1: APIs from this layer implement Grid-EYE data acquisition, transformation of temperature value and data format.
- ◆ API Lv2: APIs from this layer implement filtering of original data, and provide functions for image processing, object detection, and human body recognition.
- ◆ API Lv3 (binary code): APIs from this layer implement functions for object detection and object tracking

4.2.4 Development on Arduino

In order to be compatible with the level of 3.3V standard, we provide the demonstration program with libraries for Arduino-DUE board. If users have access to other Arduino boards, then some porting work will need to be done.

To run the demonstration, two libraries, GE_SoftUart and Grid-EYE we provided need to be copied to the Arduino libraries directory: `arduino-nightly-windows\arduino-nightly\libraries`

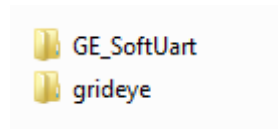

Open the *.ino file and select the corresponding target board before you start the work:



Compile the code and upload it on the board.

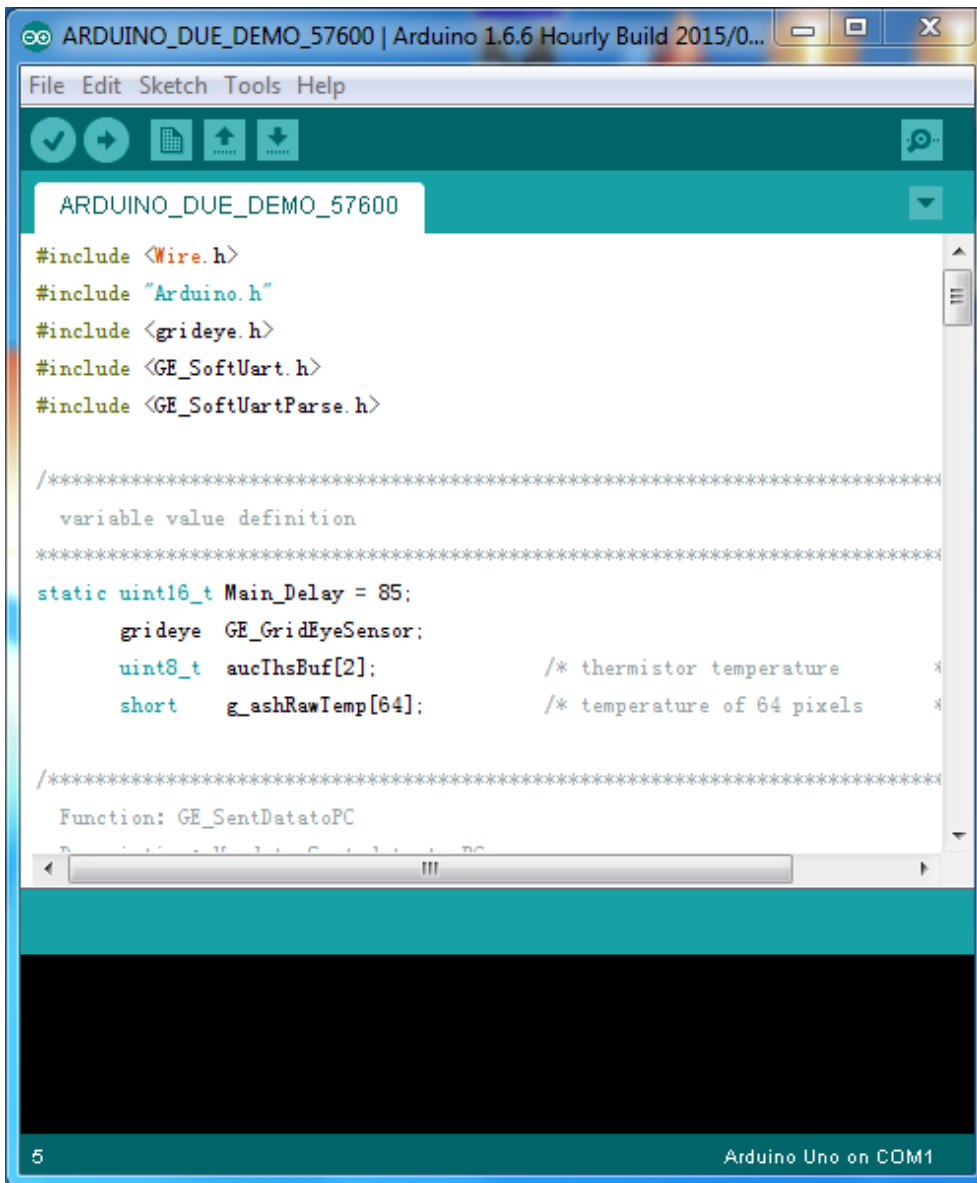

```
ARDUINO_DUE_DEMO_57600 | Arduino 1.6.5
文件 编辑 项目 工具 帮助
ARDUINO_DUE_DEMO_57600
void loop()
{
  /* Parse of the latest PC sent command */
  GE_CmdParse();

  /* Get thermistor register value. */
  GE_GridEyeSensor.bAMG_PUB_I2C_Read(0x0E, 2, aucIhsBuf );

  /* Get temperature register value. */
  for(int i=0;i<4;i++)
  {
    GE_GridEyeSensor.bAMG_PUB_I2C_Read(0x80+32*i, 32, (uint8_t *)g_ashRawTemp+i*32);
  }

  /* Send Grid-Eye sensor data to PC */
  GE_SendDataToPC();

  /* Send Grid-Eye sensor data to phone */
  GE_SendDataToPhone();

  /* set update frequency */
  GE_UpdateFerquency(GE_UpdateFreGet());
}
上传成功。
Verify successful
Set boot flash true
CPU reset.
7 Arduino Due (Programming Port) on COM52
```

4.2.5 Development on PAN1740

The Bluetooth module is PAN1740, which uses DA14580 as the main controller. The API lib we used in development is: DA14580_581_SDK_3.0.8.0

For the detail of this protocol stack, you can refer to Dialog Semiconductor’s official website: <http://support.dialog-semiconductor.com/>

Block diagram as follows:

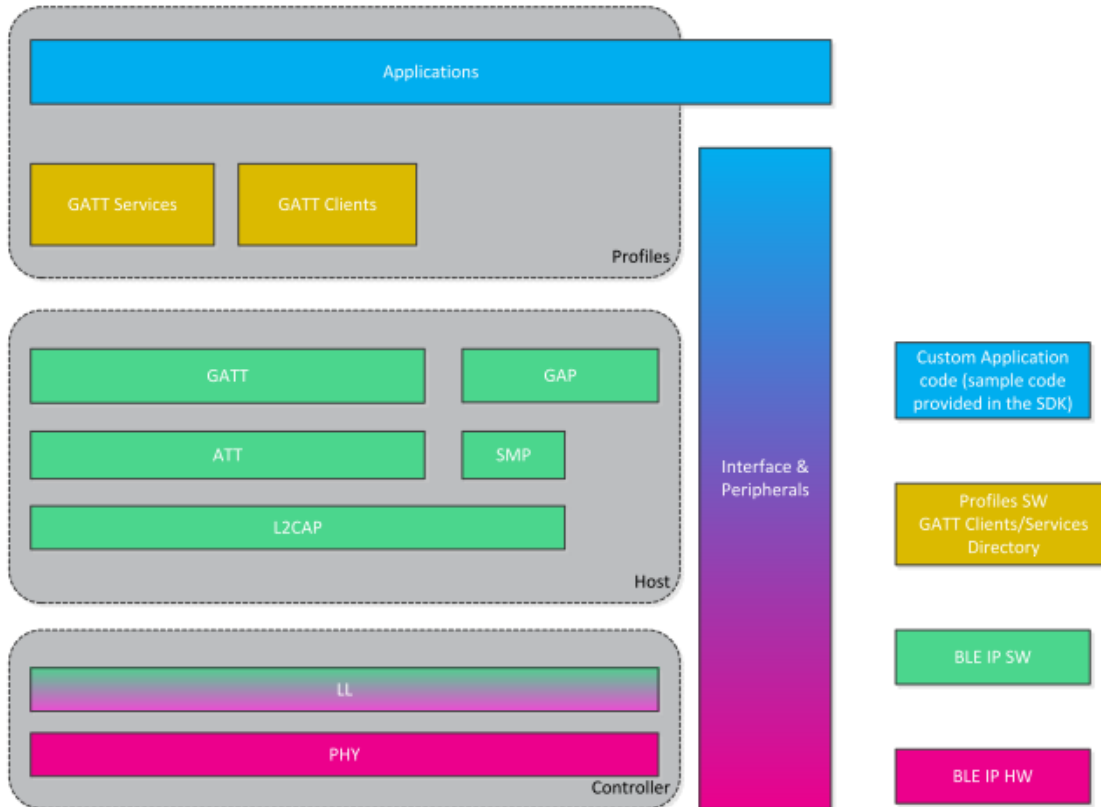

The BLUE stack and application are based on RivieraWaves Kernel OS. The “Applications” part is our application program. The BLE stack part is provided as binary code which was burnt onto the chip. Dialog Semiconductor does not provide open access to its BLE protocol stack source code but users can apply API’s provided to develop their applications.

To develop the Bluetooth firmware, you need to add the Profile to the project. The profile in our demonstration is ‘SPS’(Serial Port Service) receive application.

Below is the directory for the corresponding profile:

<table border="1"> <thead> <tr> <th></th> <th>2015/8/14 11:01</th> </tr> </thead> <tbody> <tr><td>adc_notify</td><td>2015/8/14 11:01</td></tr> <tr><td>anc</td><td>2015/8/14 11:01</td></tr> <tr><td>anp</td><td>2015/8/14 11:01</td></tr> <tr><td>bas</td><td>2015/8/14 11:01</td></tr> <tr><td>blp</td><td>2015/8/14 11:01</td></tr> <tr><td>cpp</td><td>2015/8/14 11:01</td></tr> <tr><td>cscp</td><td>2015/8/14 11:01</td></tr> <tr><td>device_config</td><td>2015/8/14 11:01</td></tr> <tr><td>dis</td><td>2015/8/14 11:01</td></tr> <tr><td>find</td><td>2015/8/14 11:01</td></tr> <tr><td>glp</td><td>2015/8/14 11:01</td></tr> <tr><td>hogp</td><td>2015/8/14 11:01</td></tr> <tr><td>hrp</td><td>2015/8/14 11:01</td></tr> <tr><td>htp</td><td>2015/8/14 11:01</td></tr> <tr><td>ieu</td><td>2015/5/19 14:27</td></tr> <tr><td>lan</td><td>2015/8/14 11:01</td></tr> <tr><td>mpu</td><td>2015/5/19 14:27</td></tr> <tr><td>pasp</td><td>2015/8/14 11:01</td></tr> <tr><td>prox</td><td>2015/8/14 11:01</td></tr> <tr><td>rscp</td><td>2015/8/14 11:01</td></tr> <tr><td>sample128</td><td>2015/8/14 11:01</td></tr> <tr><td>scpp</td><td>2015/8/14 11:01</td></tr> <tr><td>spota</td><td>2015/8/14 11:01</td></tr> <tr><td>sps</td><td>2015/8/14 11:01</td></tr> <tr><td>streamdata</td><td>2015/8/14 11:01</td></tr> <tr><td>tip</td><td>2015/8/14 11:01</td></tr> <tr><td>uds</td><td>2015/8/14 11:01</td></tr> <tr><td>wpt</td><td>2015/8/14 11:01</td></tr> <tr><td>wss</td><td>2015/8/14 11:01</td></tr> </tbody> </table>		2015/8/14 11:01	adc_notify	2015/8/14 11:01	anc	2015/8/14 11:01	anp	2015/8/14 11:01	bas	2015/8/14 11:01	blp	2015/8/14 11:01	cpp	2015/8/14 11:01	cscp	2015/8/14 11:01	device_config	2015/8/14 11:01	dis	2015/8/14 11:01	find	2015/8/14 11:01	glp	2015/8/14 11:01	hogp	2015/8/14 11:01	hrp	2015/8/14 11:01	htp	2015/8/14 11:01	ieu	2015/5/19 14:27	lan	2015/8/14 11:01	mpu	2015/5/19 14:27	pasp	2015/8/14 11:01	prox	2015/8/14 11:01	rscp	2015/8/14 11:01	sample128	2015/8/14 11:01	scpp	2015/8/14 11:01	spota	2015/8/14 11:01	sps	2015/8/14 11:01	streamdata	2015/8/14 11:01	tip	2015/8/14 11:01	uds	2015/8/14 11:01	wpt	2015/8/14 11:01	wss	2015/8/14 11:01	<table border="1"> <thead> <tr> <th>名称</th> <th>修改日期</th> </tr> </thead> <tbody> <tr><td>adc_notify</td><td>2015/8/14 11:01</td></tr> <tr><td>ancc</td><td>2015/8/14 11:01</td></tr> <tr><td>basc</td><td>2015/8/14 11:01</td></tr> <tr><td>bass</td><td>2015/8/14 11:01</td></tr> <tr><td>device_config</td><td>2015/8/14 11:01</td></tr> <tr><td>disc</td><td>2015/8/14 11:01</td></tr> <tr><td>diss</td><td>2015/8/14 11:01</td></tr> <tr><td>findme</td><td>2015/8/14 11:01</td></tr> <tr><td>ht</td><td>2015/8/14 11:01</td></tr> <tr><td>ieu</td><td>2015/5/19 14:27</td></tr> <tr><td>mpu</td><td>2015/5/19 14:27</td></tr> <tr><td>neb</td><td>2015/8/14 11:01</td></tr> <tr><td>prox_reporter</td><td>2015/8/14 11:01</td></tr> <tr><td>pru</td><td>2015/8/14 11:01</td></tr> <tr><td>ptu</td><td>2015/8/14 11:01</td></tr> <tr><td>scppc</td><td>2015/8/14 11:01</td></tr> <tr><td>spotar</td><td>2015/8/14 11:01</td></tr> <tr><td>spsc</td><td>2015/8/14 11:01</td></tr> <tr><td>spss</td><td>2015/8/14 11:01</td></tr> <tr><td>stream</td><td>2015/8/14 11:01</td></tr> <tr><td>streamdatad</td><td>2015/8/14 11:01</td></tr> <tr><td>streamdatah</td><td>2015/8/14 11:01</td></tr> </tbody> </table>	名称	修改日期	adc_notify	2015/8/14 11:01	ancc	2015/8/14 11:01	basc	2015/8/14 11:01	bass	2015/8/14 11:01	device_config	2015/8/14 11:01	disc	2015/8/14 11:01	diss	2015/8/14 11:01	findme	2015/8/14 11:01	ht	2015/8/14 11:01	ieu	2015/5/19 14:27	mpu	2015/5/19 14:27	neb	2015/8/14 11:01	prox_reporter	2015/8/14 11:01	pru	2015/8/14 11:01	ptu	2015/8/14 11:01	scppc	2015/8/14 11:01	spotar	2015/8/14 11:01	spsc	2015/8/14 11:01	spss	2015/8/14 11:01	stream	2015/8/14 11:01	streamdatad	2015/8/14 11:01	streamdatah	2015/8/14 11:01
	2015/8/14 11:01																																																																																																										
adc_notify	2015/8/14 11:01																																																																																																										
anc	2015/8/14 11:01																																																																																																										
anp	2015/8/14 11:01																																																																																																										
bas	2015/8/14 11:01																																																																																																										
blp	2015/8/14 11:01																																																																																																										
cpp	2015/8/14 11:01																																																																																																										
cscp	2015/8/14 11:01																																																																																																										
device_config	2015/8/14 11:01																																																																																																										
dis	2015/8/14 11:01																																																																																																										
find	2015/8/14 11:01																																																																																																										
glp	2015/8/14 11:01																																																																																																										
hogp	2015/8/14 11:01																																																																																																										
hrp	2015/8/14 11:01																																																																																																										
htp	2015/8/14 11:01																																																																																																										
ieu	2015/5/19 14:27																																																																																																										
lan	2015/8/14 11:01																																																																																																										
mpu	2015/5/19 14:27																																																																																																										
pasp	2015/8/14 11:01																																																																																																										
prox	2015/8/14 11:01																																																																																																										
rscp	2015/8/14 11:01																																																																																																										
sample128	2015/8/14 11:01																																																																																																										
scpp	2015/8/14 11:01																																																																																																										
spota	2015/8/14 11:01																																																																																																										
sps	2015/8/14 11:01																																																																																																										
streamdata	2015/8/14 11:01																																																																																																										
tip	2015/8/14 11:01																																																																																																										
uds	2015/8/14 11:01																																																																																																										
wpt	2015/8/14 11:01																																																																																																										
wss	2015/8/14 11:01																																																																																																										
名称	修改日期																																																																																																										
adc_notify	2015/8/14 11:01																																																																																																										
ancc	2015/8/14 11:01																																																																																																										
basc	2015/8/14 11:01																																																																																																										
bass	2015/8/14 11:01																																																																																																										
device_config	2015/8/14 11:01																																																																																																										
disc	2015/8/14 11:01																																																																																																										
diss	2015/8/14 11:01																																																																																																										
findme	2015/8/14 11:01																																																																																																										
ht	2015/8/14 11:01																																																																																																										
ieu	2015/5/19 14:27																																																																																																										
mpu	2015/5/19 14:27																																																																																																										
neb	2015/8/14 11:01																																																																																																										
prox_reporter	2015/8/14 11:01																																																																																																										
pru	2015/8/14 11:01																																																																																																										
ptu	2015/8/14 11:01																																																																																																										
scppc	2015/8/14 11:01																																																																																																										
spotar	2015/8/14 11:01																																																																																																										
spsc	2015/8/14 11:01																																																																																																										
spss	2015/8/14 11:01																																																																																																										
stream	2015/8/14 11:01																																																																																																										
streamdatad	2015/8/14 11:01																																																																																																										
streamdatah	2015/8/14 11:01																																																																																																										
src\ip\ble\hl\src\profiles	src\modules\app\src\app_profiles																																																																																																										

Add related file to project, then un-comment corresponding macro definition in “da14580_config.h”, and write your ‘app’ code.

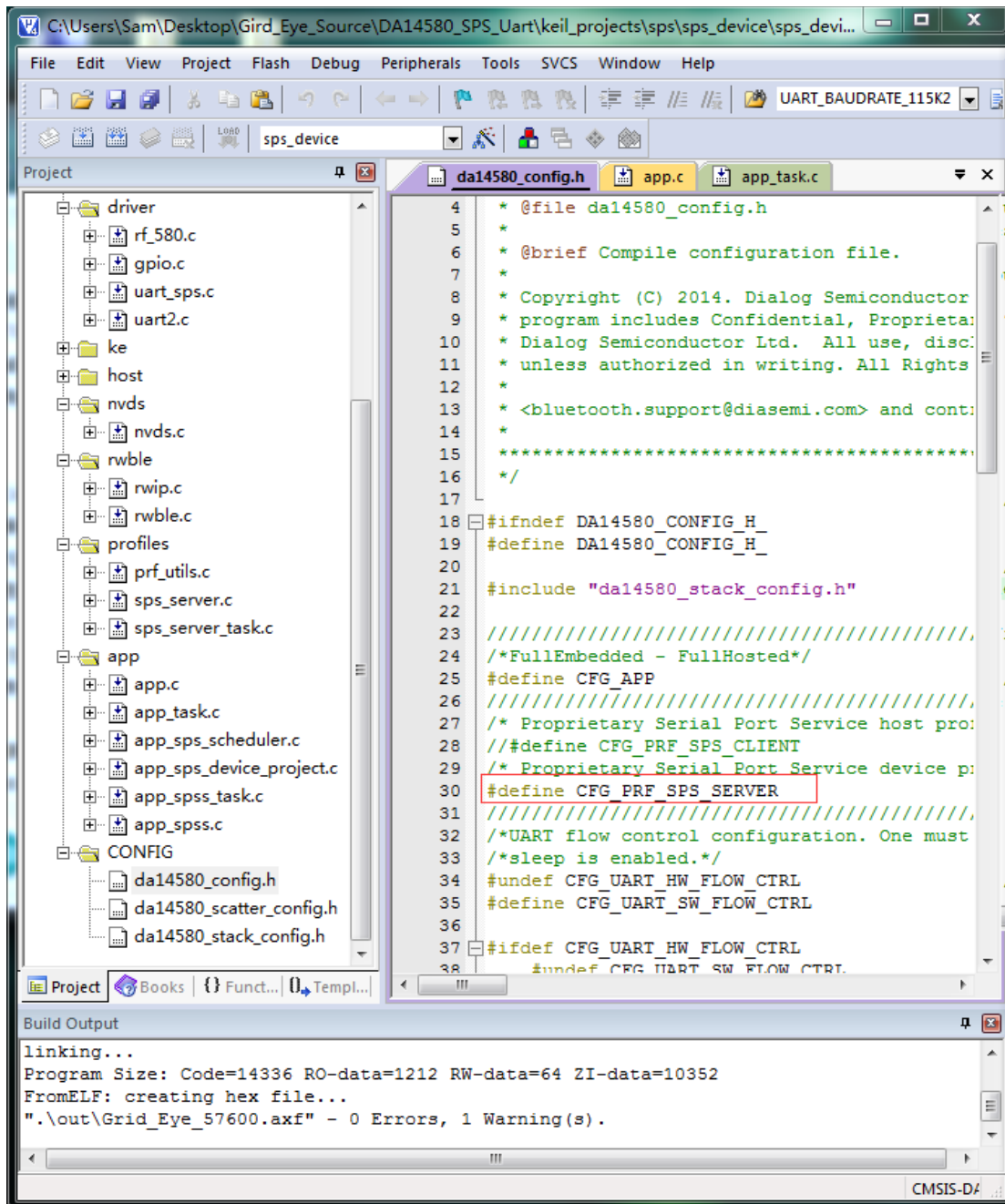

4.3 Updating firmware

4.3.1 Use USB interface to update ATSAMD21G18A

Tools and Software

- Micro-USB cable
- Software: SAM-BA v2.15

How to program

- 1) Connect USB to PC, set the jumpers, press the reset button SW1.

Jumper Number	J12	J9	J7	J10	J18
Status	ON	ON	ON	ON	ON

- 2) Open device manager to check whether there is USB CDC virtual COM. You should see the "Bossa Program Port". You need to remember the COM id that will be used in the following steps.



- 3) Open SAM-BA, select the COM id, SAMD21_xplained_pro, and then click "Connect".

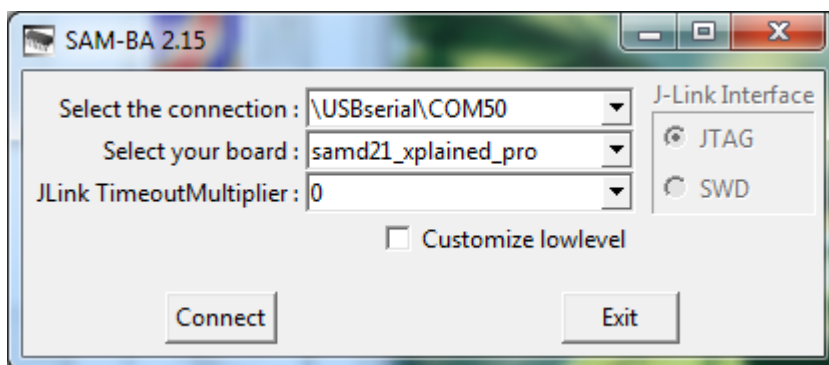

Configure the program address, select the bin file (**project path given below**) and then click "Send File". <Grid-

```
EYE\Source\ATSAMD21G18A\ATSAMD21G18A_USB_DUART_DEMO\SAMD21_USB_DUART_DEMO\Debug\SAMD21_USB_DUART_57600.bin>
```

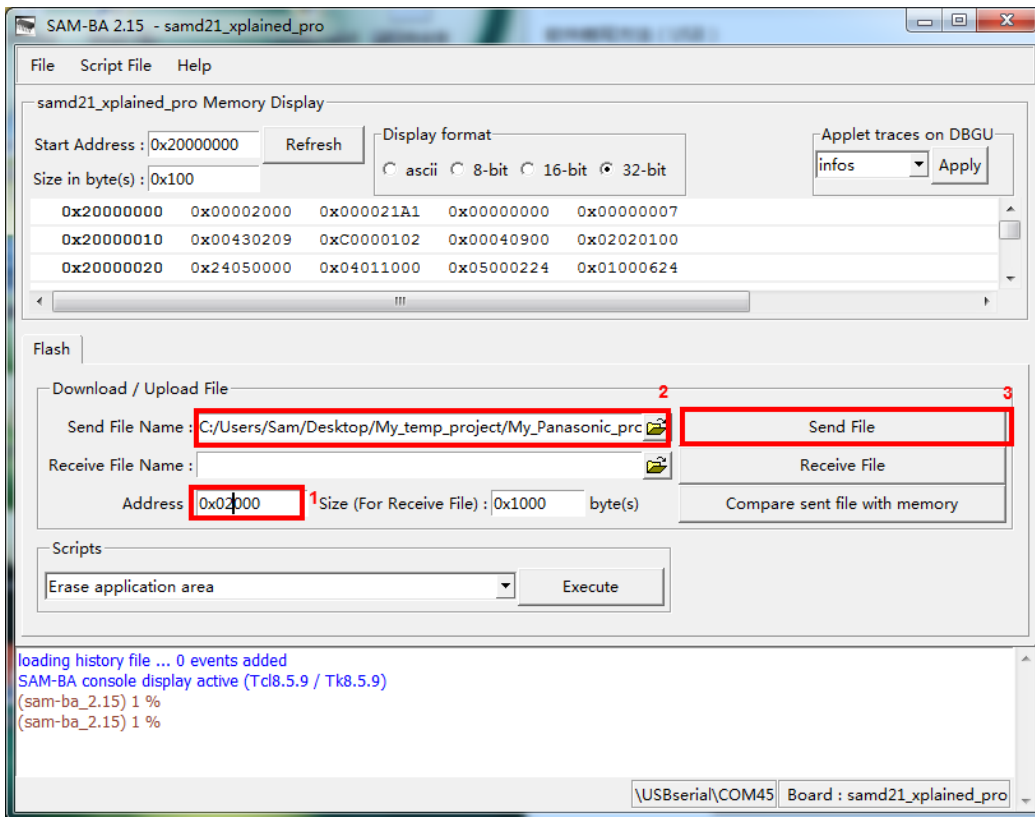

Program process:

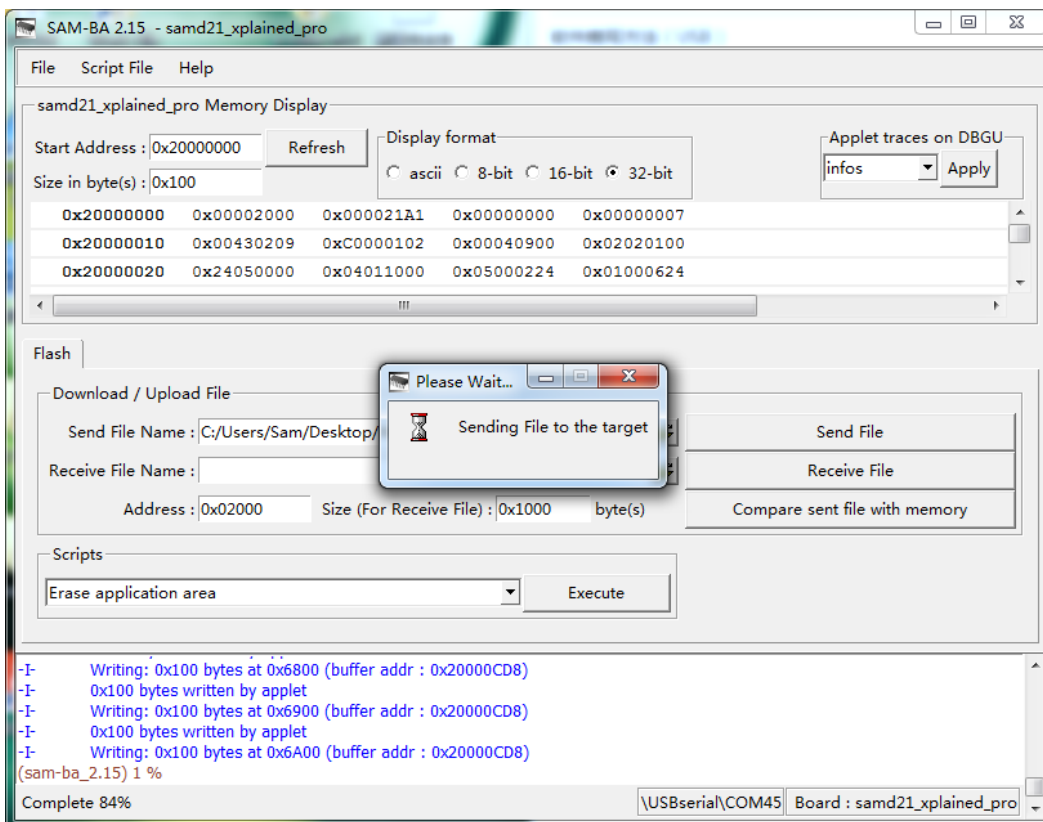

- 4) Disconnect the J18, press the reset button SW1, open device manager to check if the name of CDC virtual COM changed to “Grid Eye Sensor Board (COM x)”.

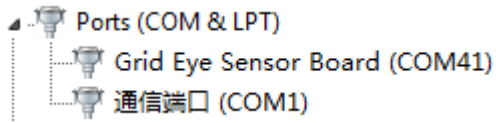

If the device manager shows as above, it means that Update ATSAMD21G18A finished successfully.

4.3.2 Use Serial interface to update PAN1740

Tools and Software

- Download tools: USB to serial module
- Software: SmartSnippets

How to program

- 1) Connect USB to PC, set the jumpers as following, connect the TX pin on Grid-EYE sensor board with RX pin of USB to serial module, and connect the RX pin on Grid-EYE sensor board with TX pin of USB to serial module.

Jumper Number	J12	J9	J7	J10	J18
Status	x	x	OFF	OFF	x

- 2) Create a download project, select UART mode, corresponding COM port, and chip version:

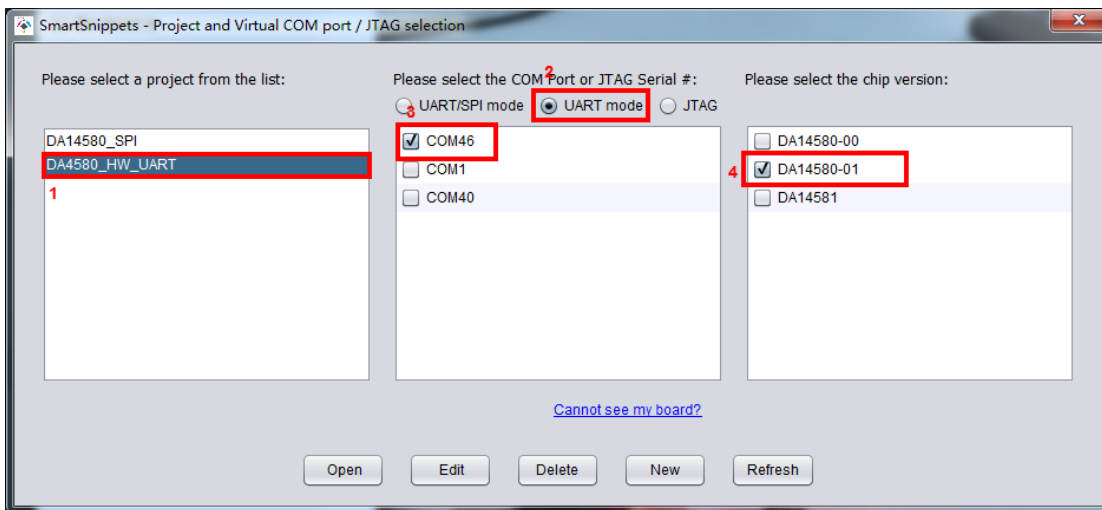

- 3) Select SPI FLASH Programmer, and then select the file to download.

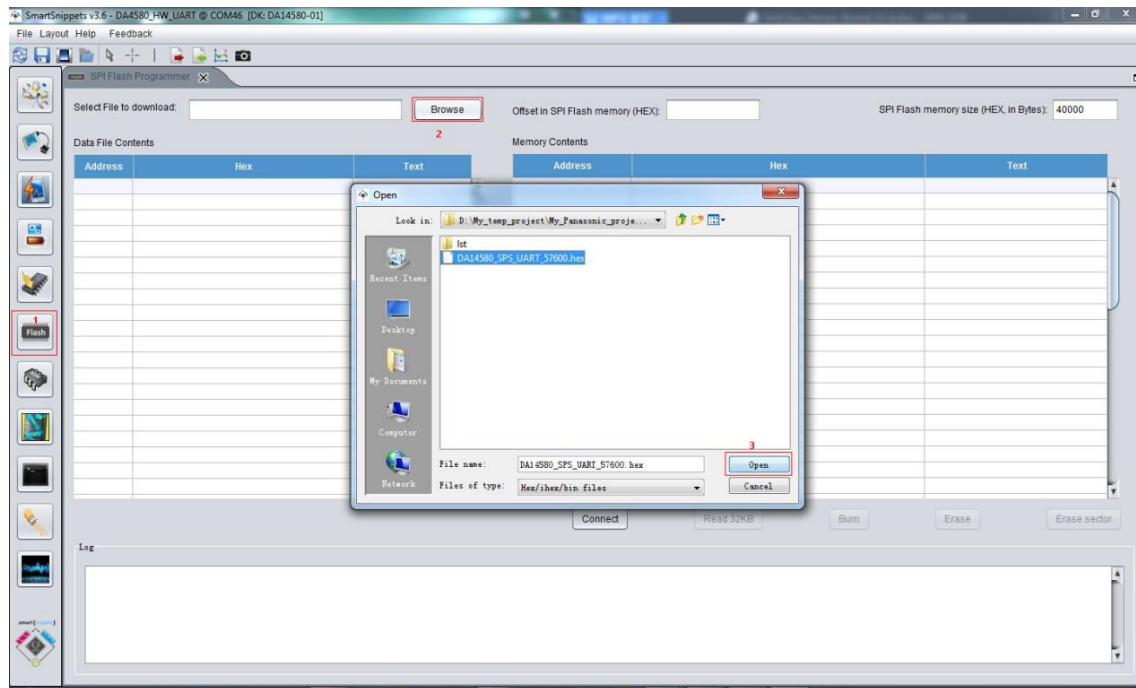

- 4) After opening the file, configure the SPI Flash memory size to be 40000, then click “Connect” button.

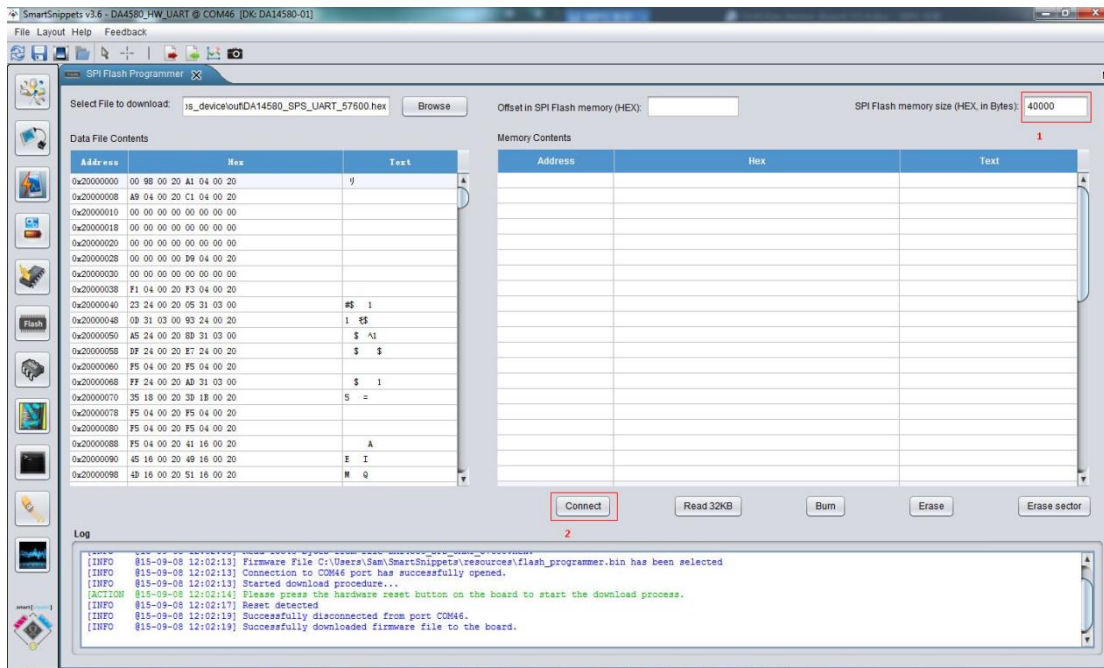

After clicking “Connect” button, the software will remind you to reset the Bluetooth module so we need to press reset button SW2 to reset the Bluetooth module.

```
[INFO @15-09-08 12:02:13] Firmware File C:\Users\Sam\SmartSnippets\resources\flash_programmer.bin has been selected
[INFO @15-09-08 12:02:13] Connection to COM46 port has successfully opened.
[INFO @15-09-08 12:02:13] Started download procedure...
[ACTION @15-09-08 12:02:14] Please press the hardware reset button on the board to start the download process.
```

- 5) If the connection is successful, there will be a prompt message in the Log window. Once you see this click “Read 32KB” button.

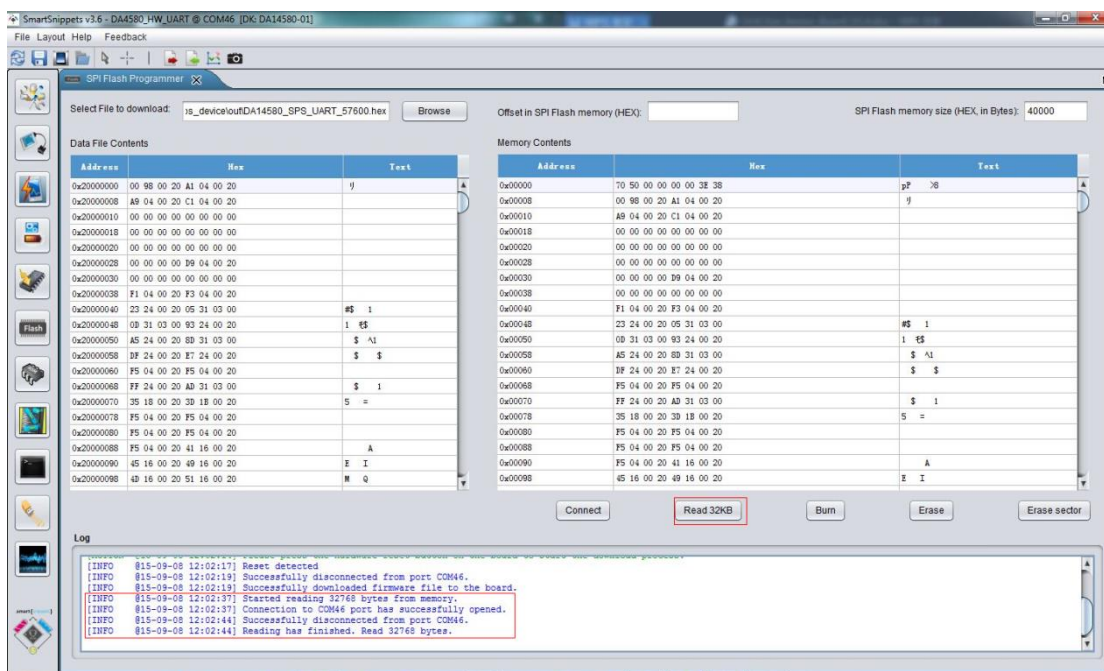

6) Then click “Erase” button after the memory is read.

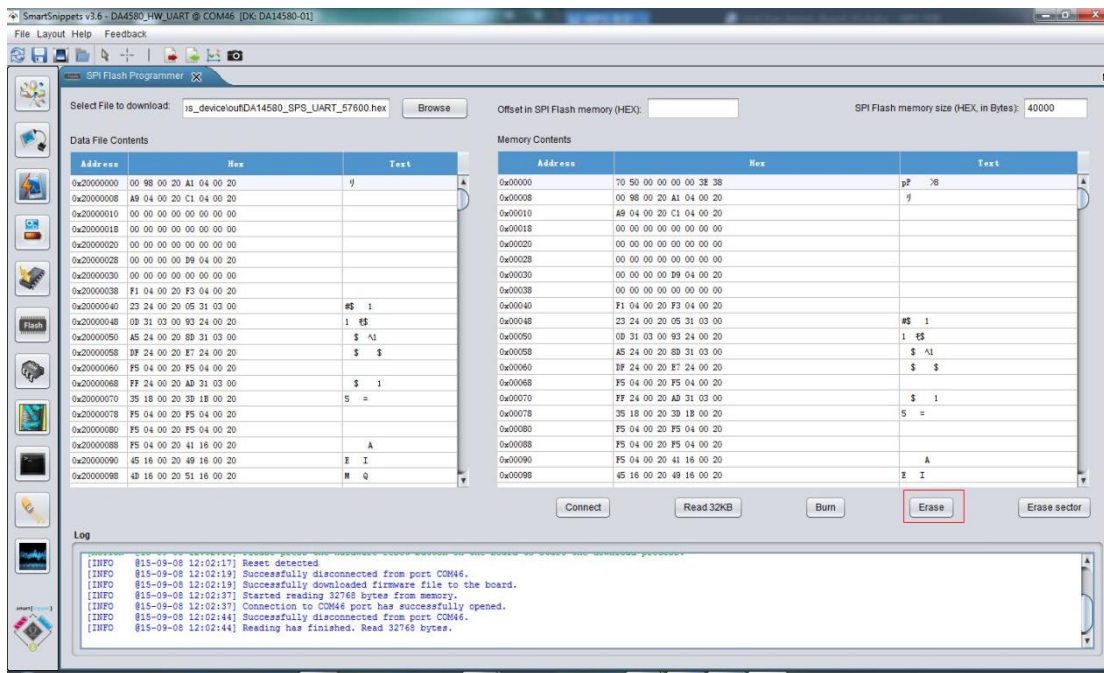

7) After erase has been finished, click “Burn” button.

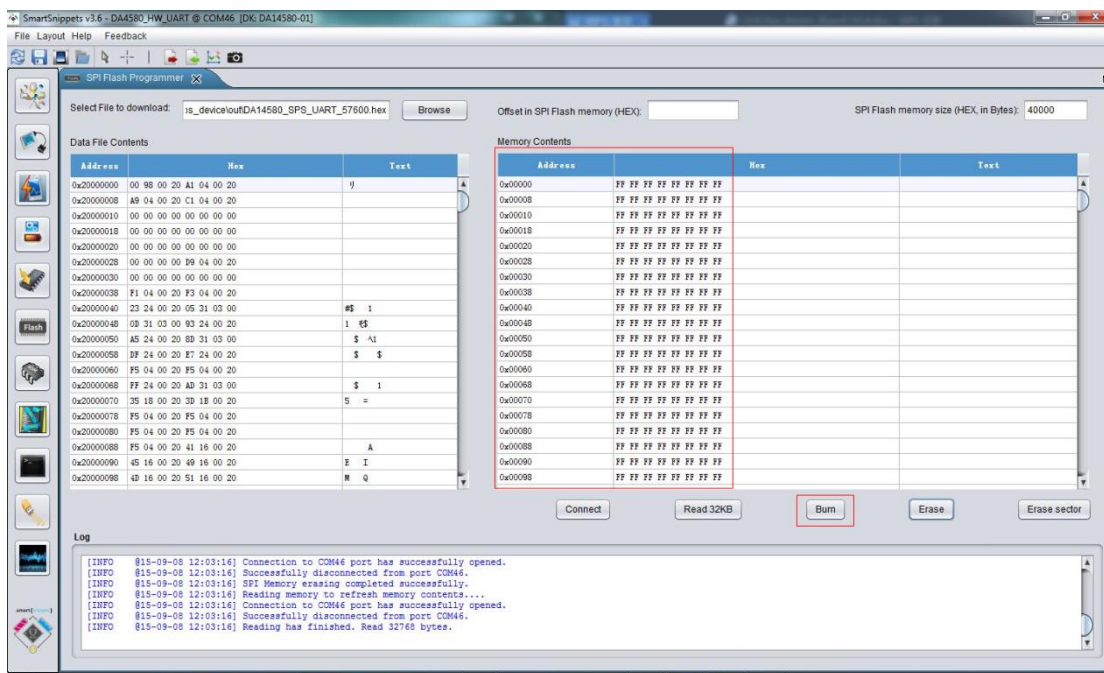

8) A pop-up window comes out after you click “Burn”, select Yes.

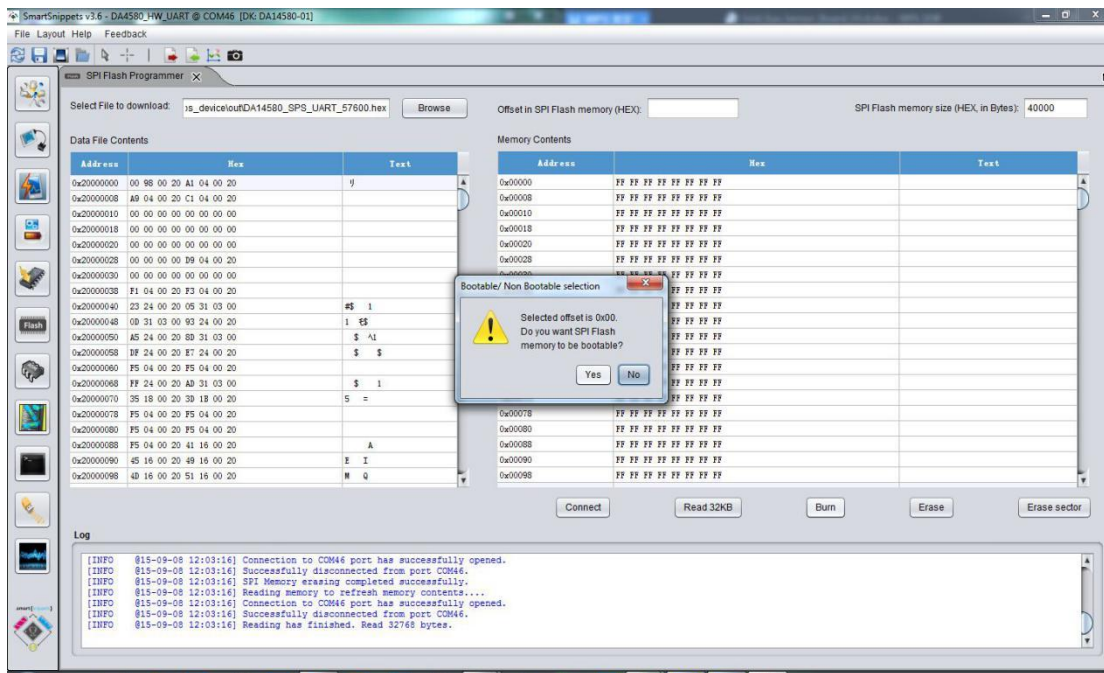

9) You will see “Memory burning completed successfully” info if everything goes well.

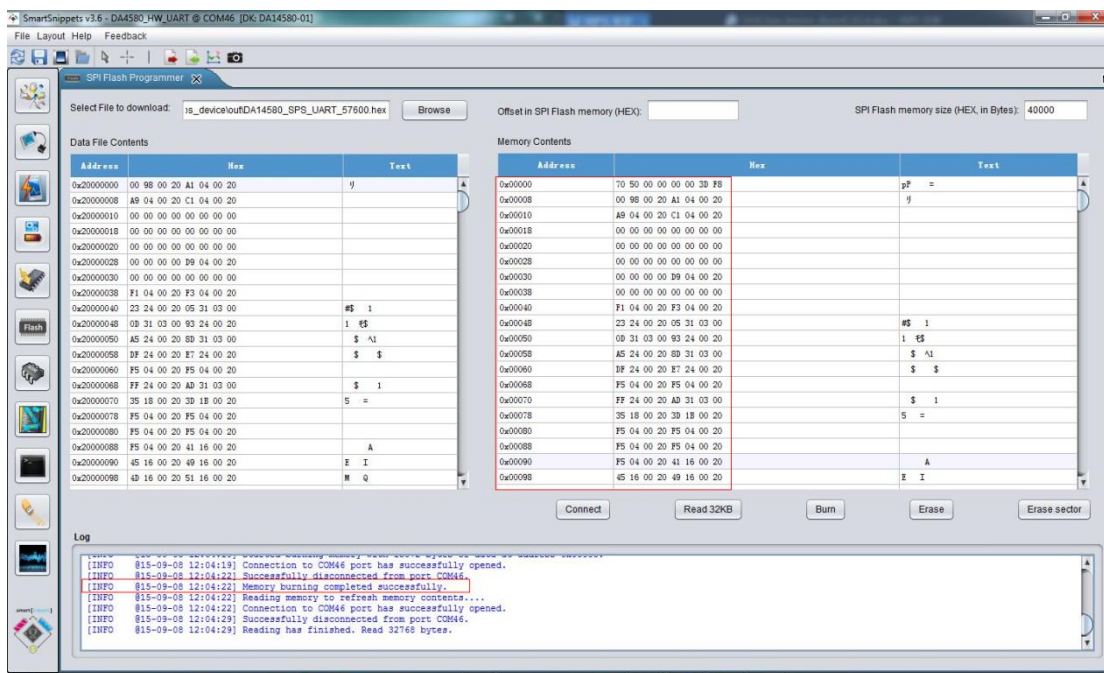

It means that Update PAN1740 finished successfully.

5 Grid-EYE Demonstration Software for PC

In this section we talk about the software that is provided with the eval-kit to demonstrate the results from the sensor. We explain here how to install this software and then run it.

5.1 Preparation

To run this demonstration, you need to:

- Install the USB driver for Grid Eye sensor board
- Install the LabVIEW program to show the temperature image
- Install the DSPS application on mobile phone to connect the Bluetooth module and show the received data

5.1.1 Jumper Setting

Operation mode can be switched through open and close the following jumper:

Jumper Number	J12	J9	J7	J10	J18
Independent Mode	ON	ON	ON	ON	OFF
Arduino Expansion Mode	OFF	OFF	ON	ON	OFF

5.2 Demonstration

5.2.1 Independent Mode Demonstration

- 1) Connect USB to PC, set the jumpers, and check if LED D3 starts to blink.

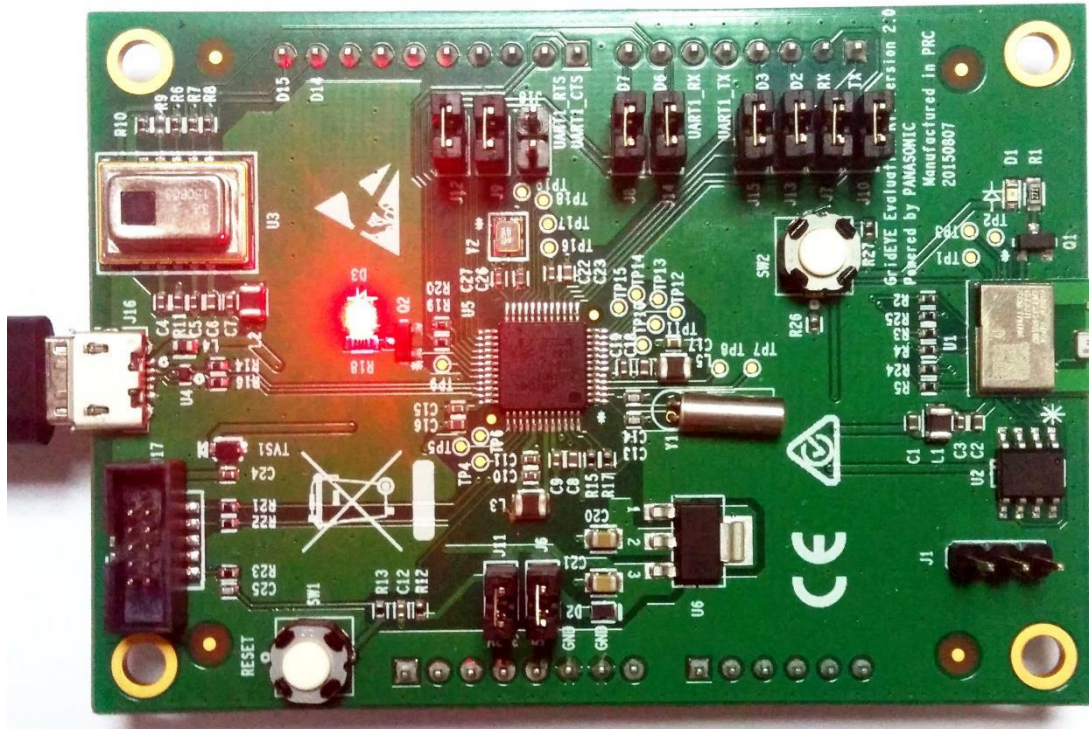

Note: If LED D3 blinks every second, it indicates that USB device is recognized correctly by the PC. If the LED does not blink at this frequency, it indicates that USB does not work normally, please check the USB driver and USB cable.

- 2) Open device manager to check the COM id for USB virtual COM

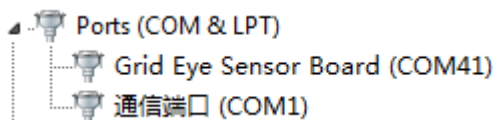

If the COM port is not detected then reinstall the USB driver from

<http://eu.industrial.panasonic.com/grideye-evalkit> under

Software & Source Code for Download > MCU Firmware >

ATSAMD21G18A\ATSAMD21G18A_USB_DUART_DEMO\SAMD21_USB_DUART_DEMO

(the files used are: atmel_devices_cdc.cat and atmel_devices_cdc.inf).

- 3) Run Grid-EYE application (Windows Start>>Grid-EYE>>Open Grid-EYE application)
If compatibility issues are encountered then reinstall the LabVIEW Run-Time Engine 2014 from www.ni.com or from the supplied folder with appropriate 32bit or 64bit versions.
- 4) Now select the appropriate COM port (shown as COM41 in the image below), and click 'Open COM' button to view the data fed to the PC from the Grid-EYE sensor.

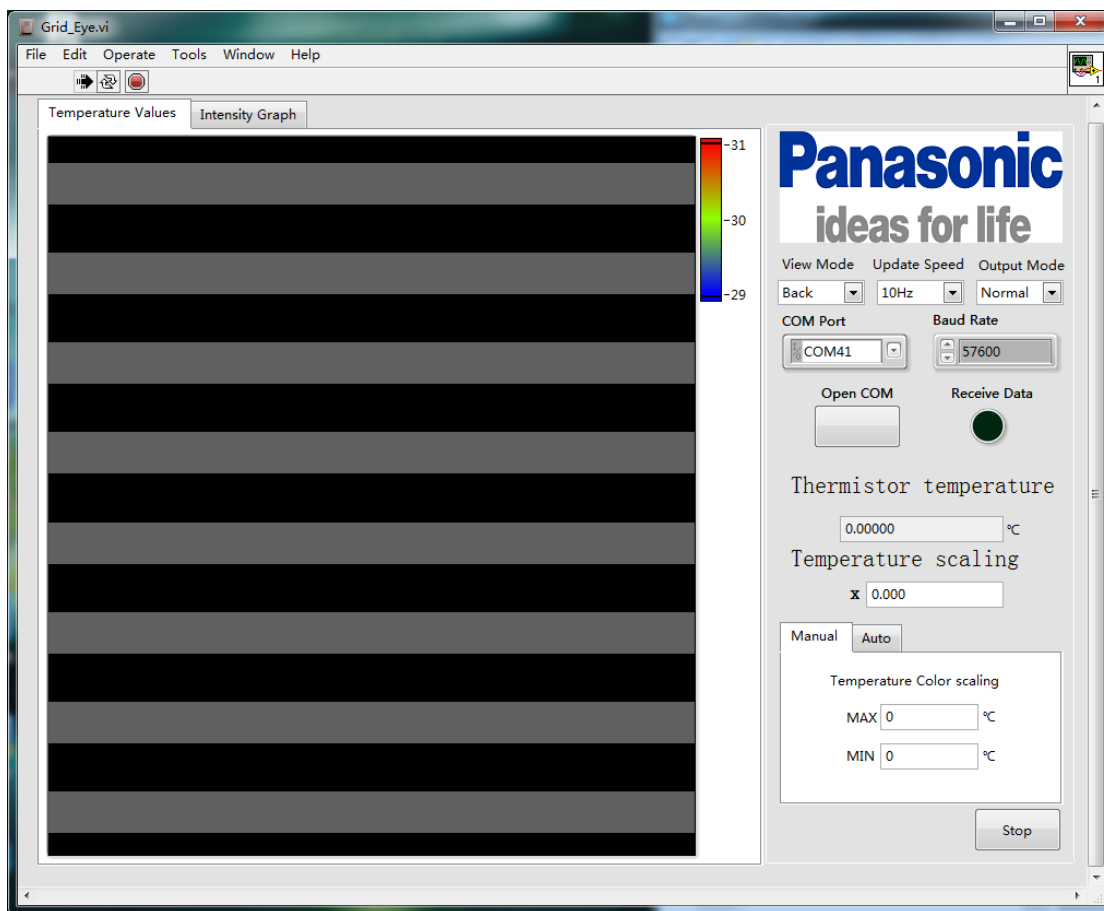

Temperature data detected:

Temperature values can be observed on the LabVIEW (8 x 8) matrix window. Colours for the heat map can be set between -20°C and +100°C. The second tab is showing an interpolation of the raw signal.

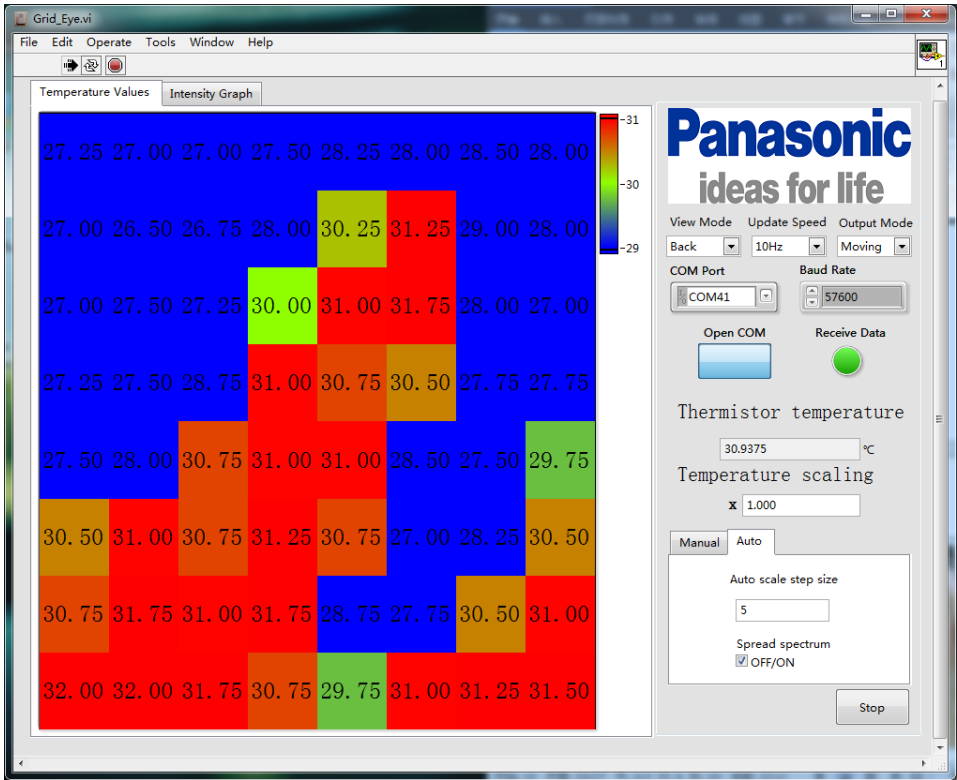
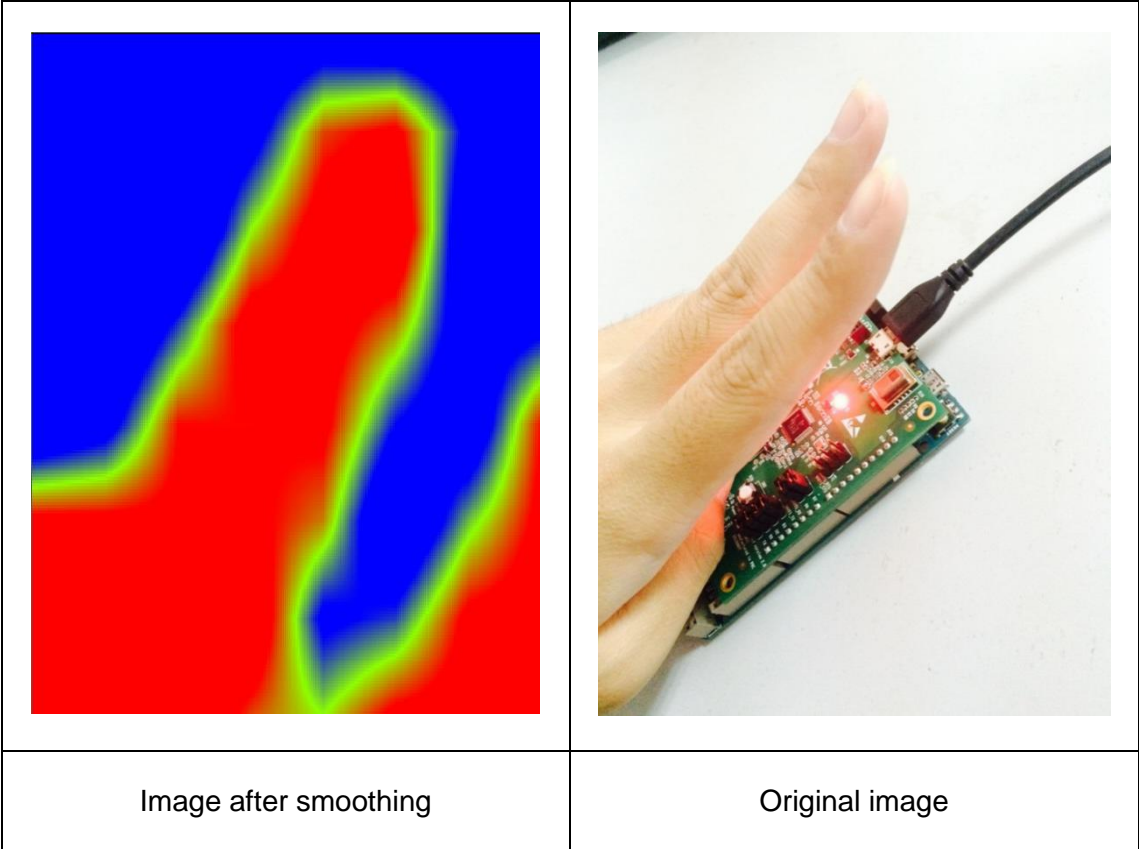
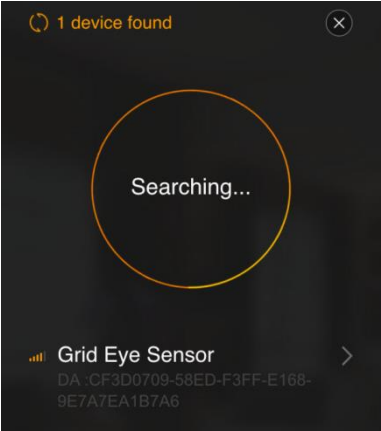

Image after interpolation and the original image:



- 5) Open the DSPS / Panasonic 'app' on the smartphone and connect with Grid-EYE sensor, view the data sent over Bluetooth.



5.2.2 Arduino Mode Demonstration

- 1) Plug the Grid-EYE sensor board to Arduino mother board, set the jumpers, and connect the USB interface.

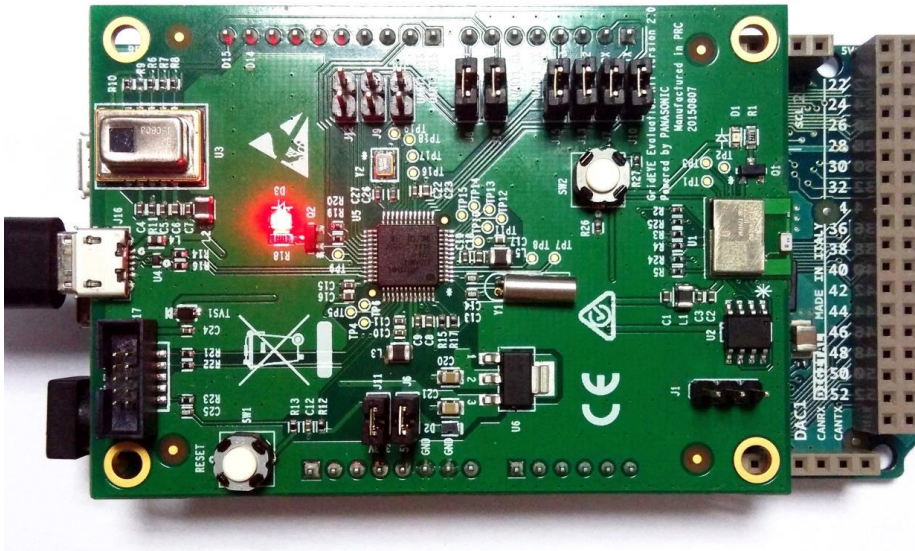

- 2) Open device manager to check the COM id for USB virtual COM.

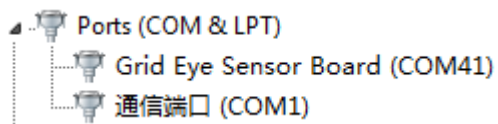

3) Open PC software, select the corresponding COM port.

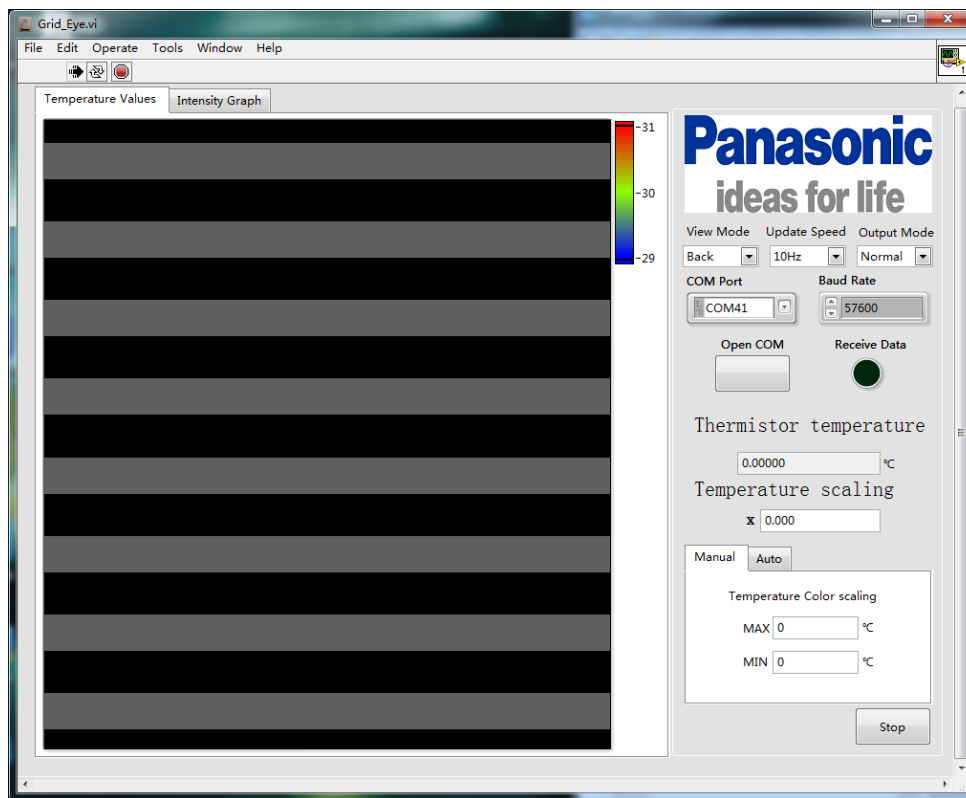

4) Open Com to view the output.

Temperature data detected:

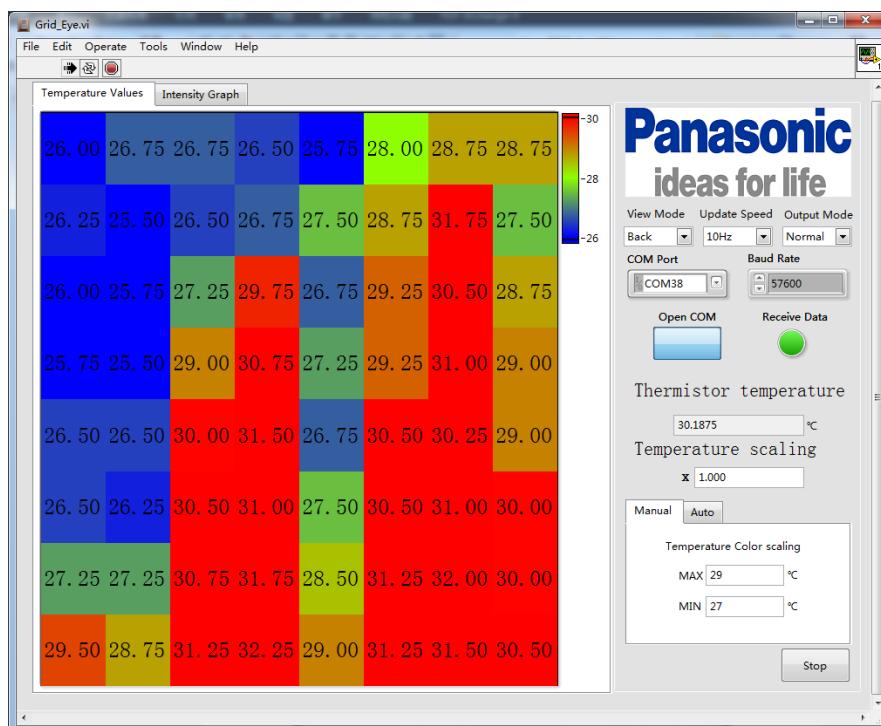
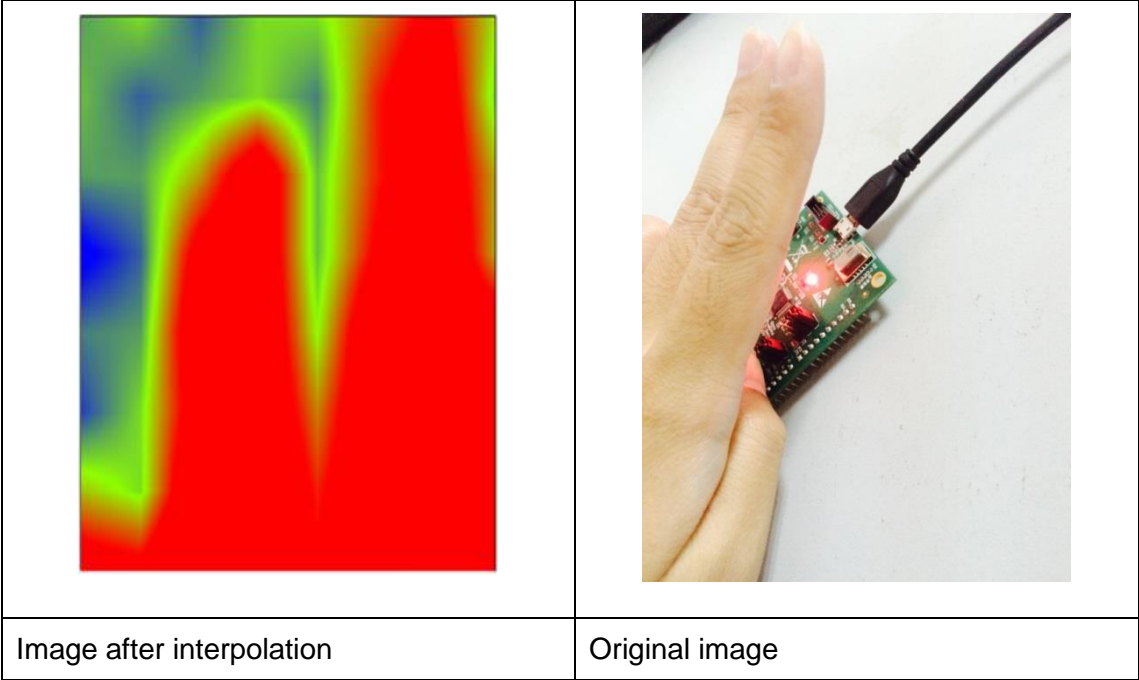

Image after interpolation and the original image:



5) Open the DSPS /Panasonic 'app' on the smartphone and connect with Grid-EYE sensor, view the data sent over Bluetooth.



6 Appendix

6.1 Install USB Driver for ATSAMD21G18A

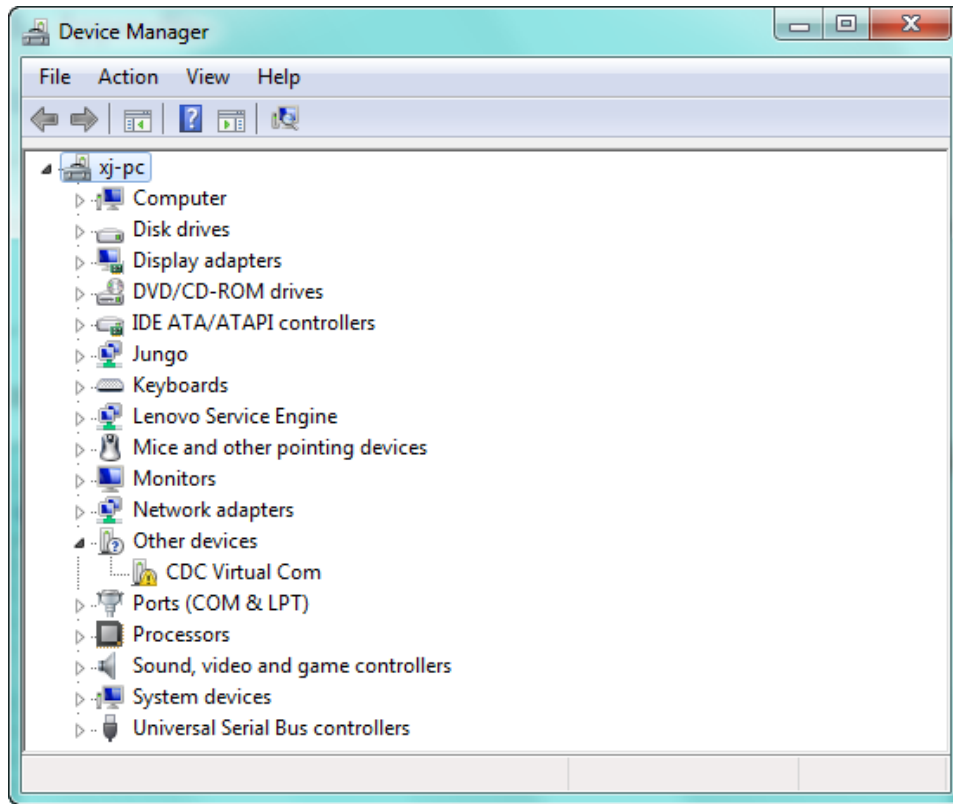

- 1) Open Device manager, if you haven't installed the USB Driver, you will find the "CDC Virtual Com" in "Other" devices tag with a yellow exclamation mark on it.

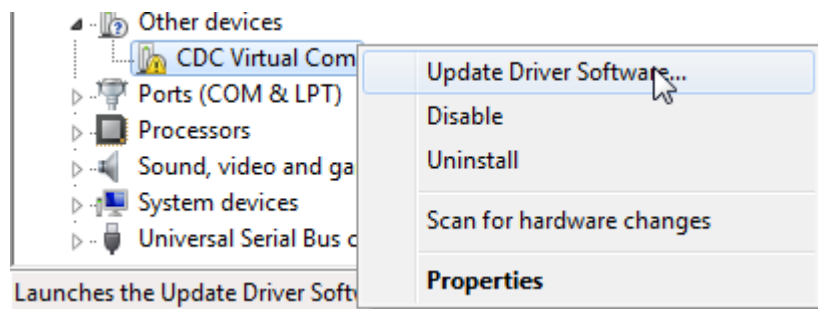

- 2) Right click the device name, then choose Update Driver Software supplied in the USB driver folder.

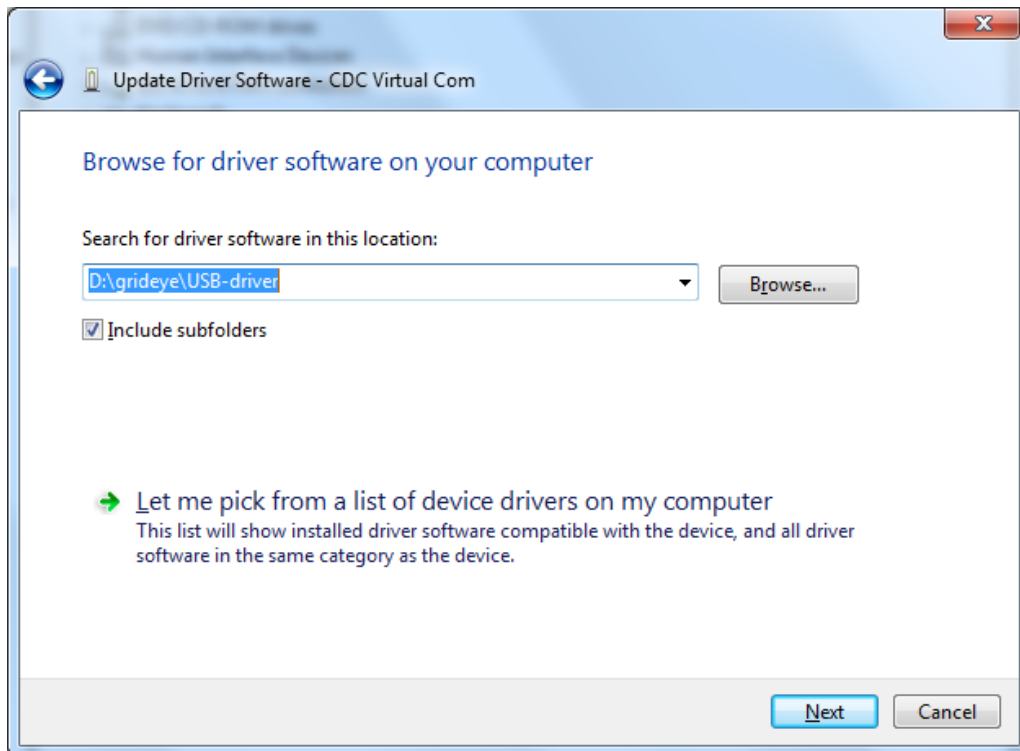

- 3) Choose "Browse my computer for driver software", select the driver path.

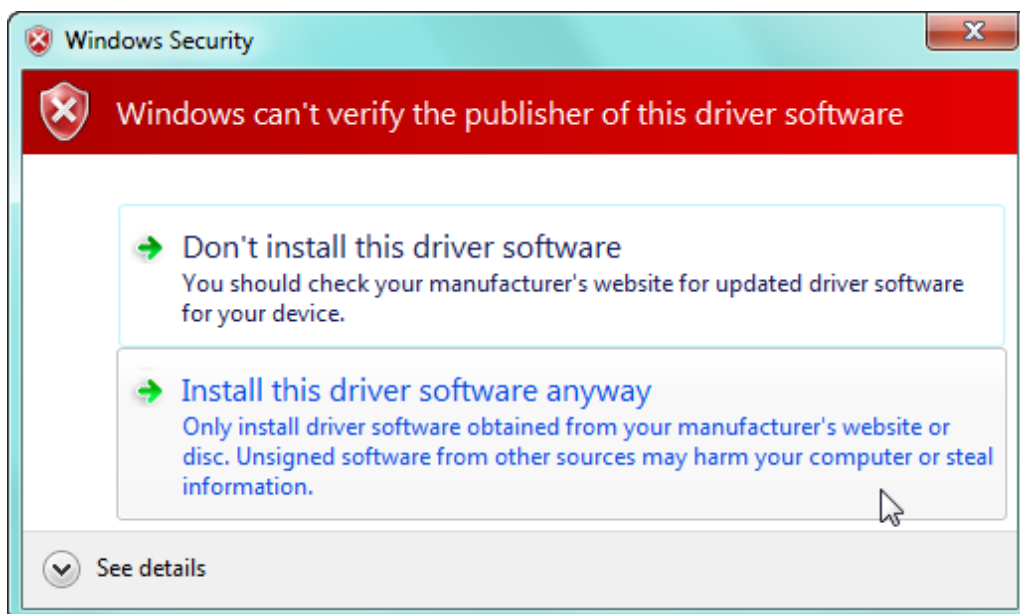

4) Choose Install this driver software anyway, then wait for the complement of installation.

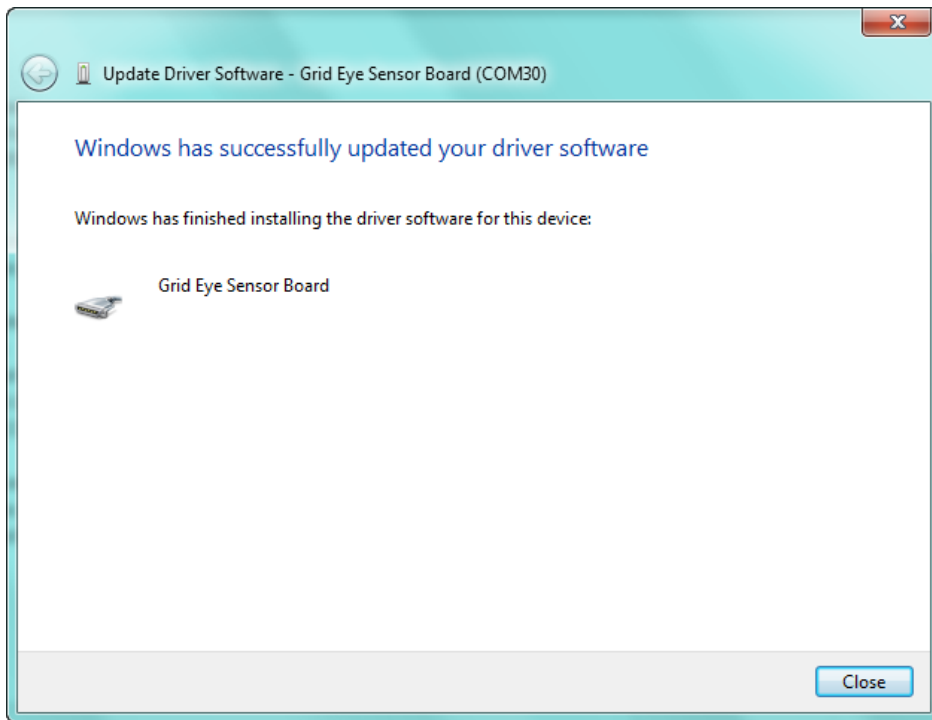

5) You will see the following after install is finished.

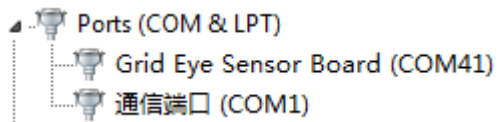





7 ESD precautions and proper handling procedures

This section includes the precautions for mechanical handling and static precautions to be taken to avoid ESD damage:

- Avoid carpets in cool, dry areas. Leave development kits in their anti-static packaging until ready to be installed.
- Dissipate static electricity before handling any system components (development kits) by touching a grounded metal object, such as the system unit unpainted metal chassis.
- If possible, use antistatic devices, such as wrist straps and floor mats.
- Always hold an evaluation board by its edges. Avoid touching the contacts and components on the board.
- Take care when connecting or disconnecting cables. A damaged cable can cause a short in the electrical circuit.
- Prevent damage to the connectors by aligning connector pins before you connect the cable. Misaligned connector pins can cause damage to system components at power-on.
- When disconnecting a cable, always pull on the cable connector or strain-relief loop, not on the cable itself.

8 Compliance Information

    CAN ICES-3 (B)/NMB-3(B) | Contains FCC ID: T7V1740 | Contains IC:
216Q-1740

This device complies with Part 15 of the FCC Rules. Operation is subject to the following two conditions:

(1) this device may not cause harmful interference, and (2) this device must accept any interference received, including interference that may cause undesired operation.

Note: This equipment has been tested and found to comply with the limits for a Class B digital device, pursuant to part 15 of the FCC Rules. These limits are designed to provide reasonable protection against harmful interference in a residential installation. This equipment generates, uses and can radiate radio frequency energy and, if not installed and used in accordance with the instructions, may cause harmful interference to radio communications. However, there is no guarantee that interference will not occur in a particular installation. If this equipment does cause harmful interference to radio or television reception, which can be determined by turning the equipment off and on, the user is encouraged to try to correct the interference by one or more of the following measures:

- Reorient or relocate the receiving antenna.
- Increase the separation between the equipment and receiver.
- Connect the equipment into an outlet on a circuit different from that to which the receiver is connected.
- Consult the dealer or an experienced radio/TV technician for help

X-ON Electronics

Largest Supplier of Electrical and Electronic Components

Click to view similar products for [embest](#) manufacturer:

Other Similar products are found below :

[CAM8000-D MODULE](#) [SBC8118 WITH 4.3"LCD](#) [DEVKIT8500D WITHOUT LCD](#) [MARS BOARD WITH 9.7"LCD](#) [CAM8200-U](#)
[MODULE](#) [COLINKEX](#) [MINI6245 PROCESSOR CARD](#) [EMBEDDED PI](#) [EVK-PH8800](#) [AMG8832EK](#) [SBC-EC8800](#) [1401148](#)