

CMF2012F Series

Common Mode SMD Filter for Signal Line

FEATURES

- This common mode filter is characterized by its small sized
- Highly effective in noise suppression. High common-mode impedance at noise band and low differential-mode impedance at signal band.
- Due to the low differential-mode impedance with high coupling factor, there is almost no distortion on high speed signal.
- This series is micro-produced by auto machines for its huge productivity and accuracy with all-day CCD inspection.

APPLICATIONS

- Used for noise suppression in any electronic devices such as personal computer and peripheral equipment (USB), amusement equipment (IEEE 1394), LCD panels (LVDS) etc.

SHAPES AND DIMENSIONS

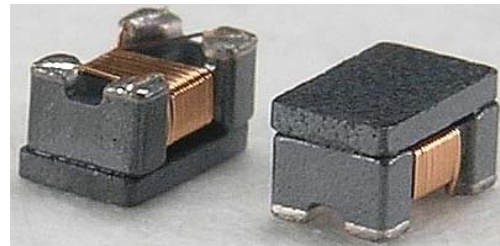
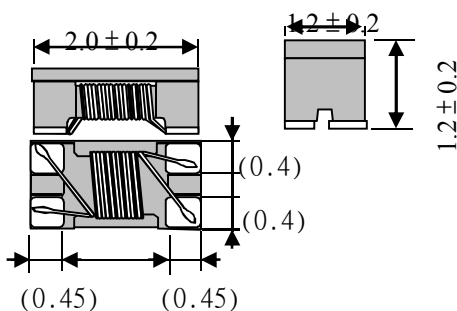

PRODUCT IDENTIFICATION

CMF 2012 F - 900 - 2P - T

(1) (2) (3) (4) (5) (6)

- (1) Product name
- (2) Shapes and Dimensions
- (3) Shielding type
- (4) Impedance[at 100MHz]
121:120Ω
- (5) Number of line
2P:2-Line
- (6) Taping style

RECOMMENDED FOOTPRINT

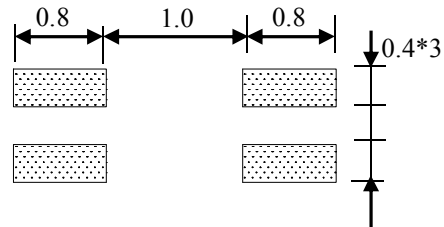

Unit:mm

ELECTRICAL CHARACTERISTICS

Our Product Part Number	Common-Mode Impedance Z(Ω) at 100MHz	DC Resistance Rdc(Ω) Max.	Rated Current Idc(mA) Max.	Rated Voltage Vdc(V)	Insulation Resistance (MΩ)Min.
CMF2012F-300-2P-T	30 ±25%	0.20	450	50	10
CMF2012F-400-2P-T	40 ±25%	0.12	500	50	10
CMF2012F-670-2P-T	67 ±25%	0.25	400	50	10
CMF2012F-750-2P-T	75 ±25%	0.30	400	50	10
CMF2012F-900-2P-T	90 ±25%	0.30	400	50	10
CMF2012F-121-2P-T	120±25%	0.30	370	50	10
CMF2012F-161-2P-T	160±25%	0.30	340	50	10
CMF2012F-181-2P-T	180±25%	0.35	330	50	10
CMF2012F-201-2P-T	200±25%	0.35	330	50	10
CMF2012F-221-2P-T	220±25%	0.35	330	50	10
CMF2012F-261-2P-T	260±25%	0.40	300	50	10
CMF2012F-371-2P-T	370±25%	0.40	280	50	10
CMF2012F-601-2P-T	600±25%	0.375	250	50	10
CMF2012F-670-2P-T	670±25%	0.60	150	50	10
CMF2012F-901-2P-T	900±25%	0.80	120	50	10
CMF2012F-102-2P-T	1000±25%	0.80	100	50	10
CMF2012F-222-2P-T	2200±25%	0.14	100	50	10

CMF2012F Series

Common Mode SMD Filter for Signal Line

Characteristics(Impedance vs. Frequency)

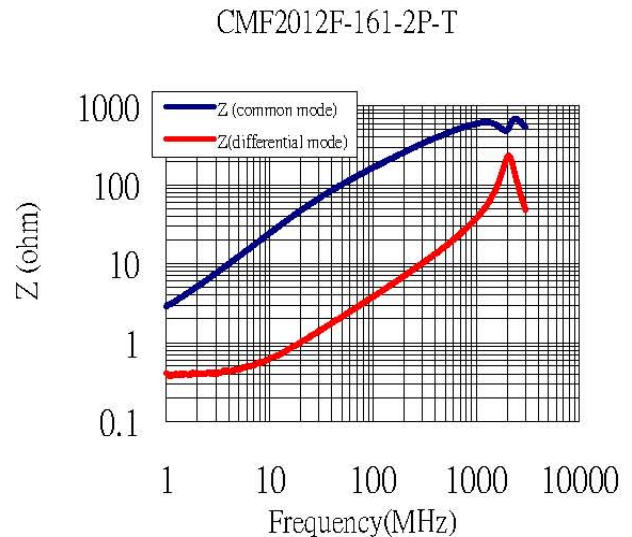
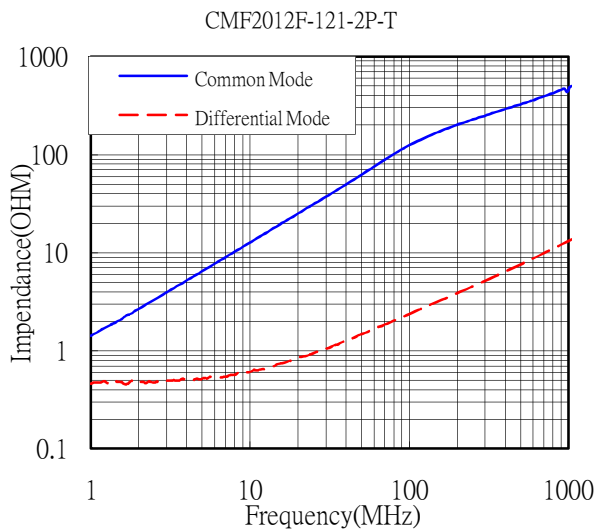
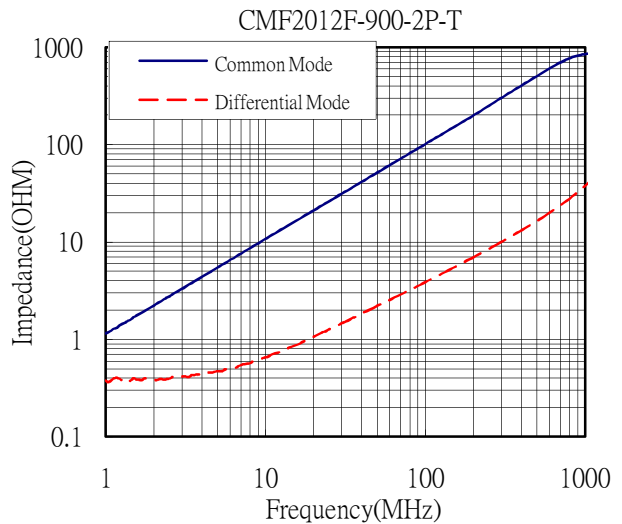
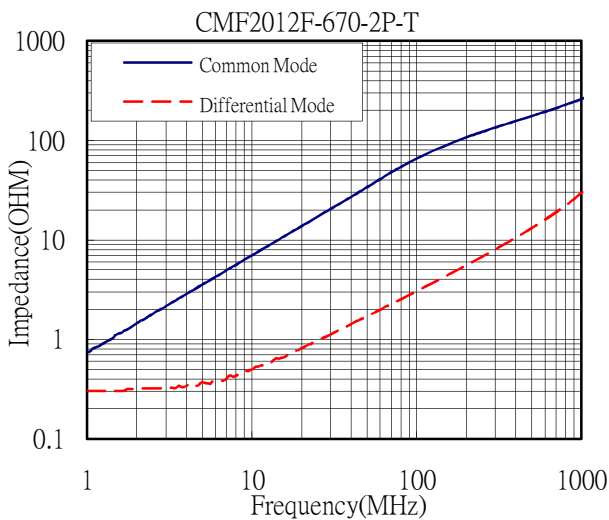
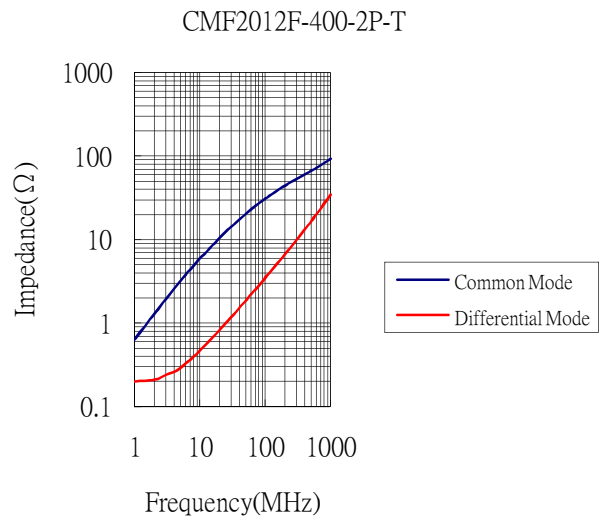
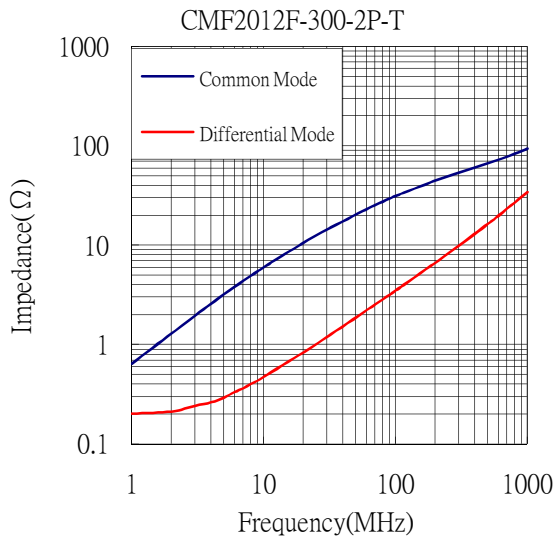

CMF2012F Series

Common Mode SMD Filter for Signal Line

Characteristics(Impedance vs. Frequency)

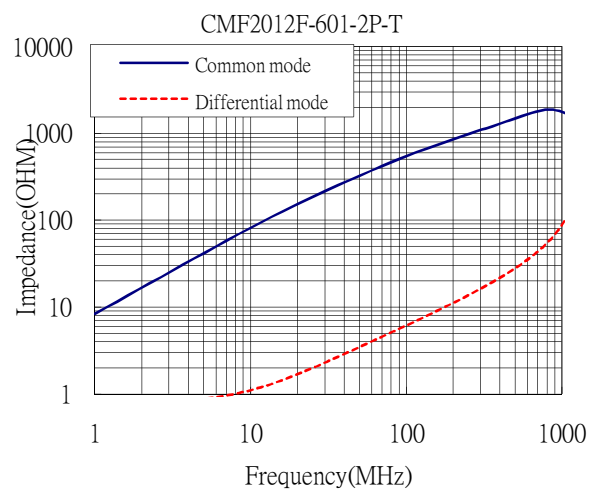
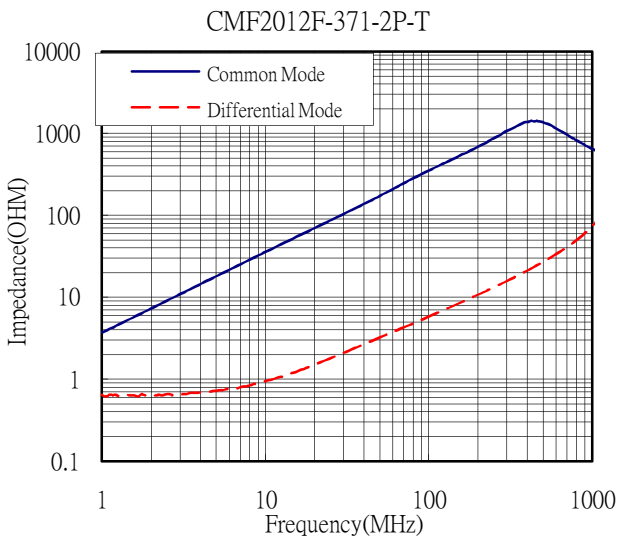
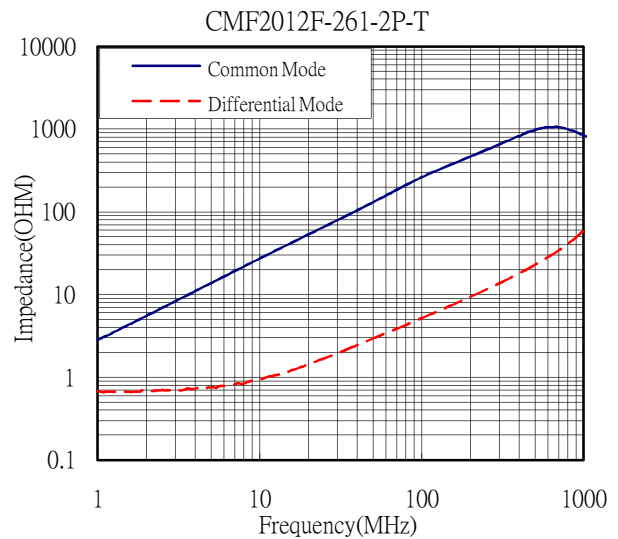
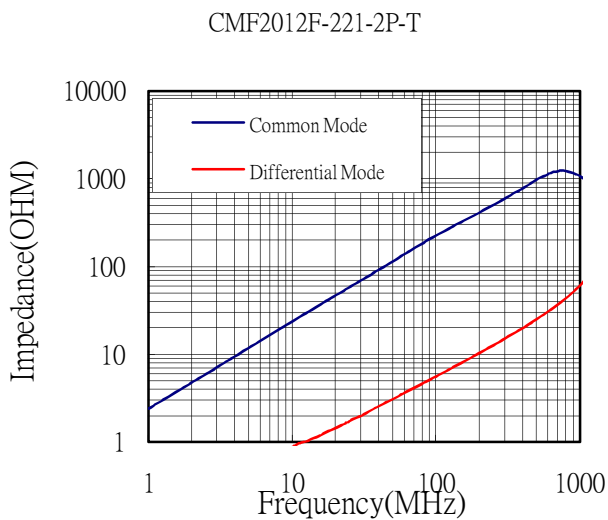
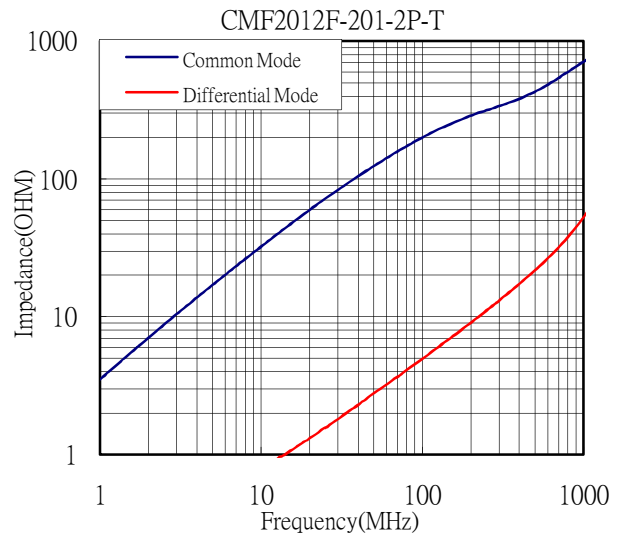
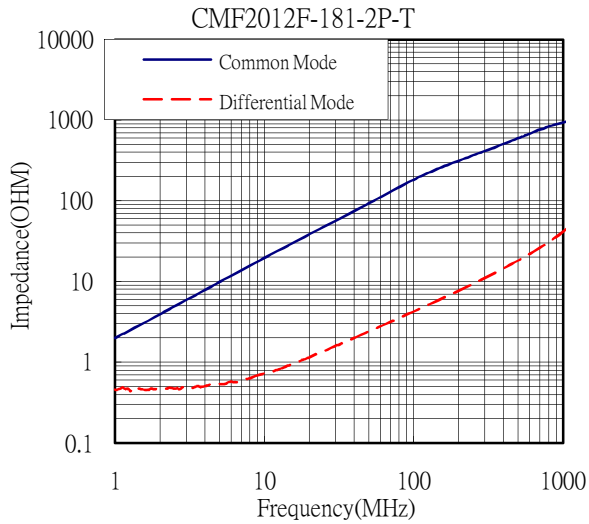

CMF2012F Series

Common Mode SMD Filter for Signal Line

Characteristics(Impedance vs. Frequency)

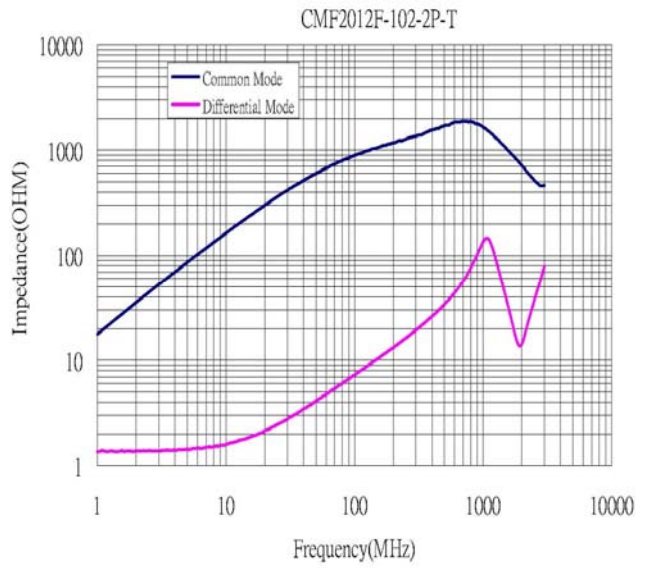
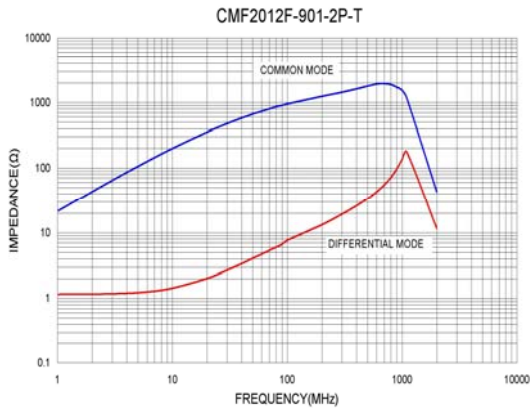

X-ON Electronics

Largest Supplier of Electrical and Electronic Components

Click to view similar products for [Common Mode Chokes / Filters](#) category:

Click to view products by [EMTEK](#) manufacturer:

Other Similar products are found below :

[74279408](#) [PE-62911NL](#) [PE-64683](#) [RD5122-6-9M6](#) [RGCMF1210900H3T](#) [ST6118T-R](#) [FE3X025-10-7NL](#) [T8114NLT](#) [RD5122-10-6M0](#)
[TCM0806G-350-2P-T](#) [TCM0806G-650-2P-T](#) [B2013FNLT](#) [IND-0110](#) [UAL21VR0802000](#) [UALSC023000000](#) [UALSC1020JH000](#)
[UALSU10VR15019](#) [UALSU9VD070100](#) [36-00037](#) [5701610000](#) [UALW21HS072450](#) [UALSU9HF050500](#) [UALSU9H0208000](#)
[UAL24VK06450CH](#) [PLT10HH501100PNB](#) [PLT10HH401100PNB](#) [PLT10HH1026R0PNB](#) [PE-67531](#) [TLH10UB](#) [113 0R5](#) [2752045447](#)
[CMS3-11-R](#) [7351V](#) [CMF16-153131](#) [744252510](#) [T8116NLT](#) [CMS2-10-R](#) [FE2X10-4-2NL](#) [744253200](#) [744253101](#) [744252220](#) [TX8111NLT](#)
[UAL30VR3500470](#) [CTX01-19077-R](#) [T8003NLT](#) [CTX01-13663](#) [CTX66-19521-R](#) [7446630047](#) [744136](#) [744150](#) [RC212-0.25-47M](#)