

CMF3216F Series

Common Mode SMD Filter for Signal Line

FEATURES

- This common mode filter is characterized by its small sized
- Highly effective in noise suppression. High common-mode impedance at noise band and low differential-mode impedance at signal band.
- Due to the low differential-mode impedance with high coupling factor, there is almost no distortion on high speed signal.
- This series is micro-produced by auto machines for its huge productivity and accuracy with all-day CCD inspection.

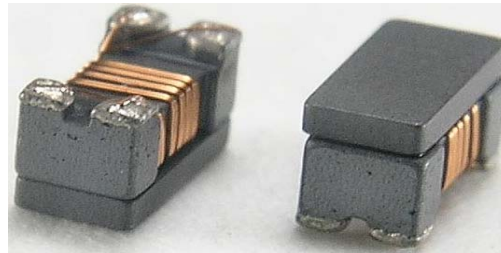

PRODUCT IDENTIFICATION

CMF 3216 F - 900 - 2P - T

(1) (2) (3) (4) (5) (6)

- (1) Product name
 (2) Shapes and Dimensions
 (3) Shielding type
 (4) Impedance[at 100MHz] 900:90Ω

APPLICATIONS

- Used for noise suppression in any electronic devices such as personal computer and periphera equipment (USB), amusement equipment (IEEE LCD panels (LVDS) etc.

- (5) Number of line 2P:2-Line
 (6) Taping style

SHAPES AND DIMENSIONS

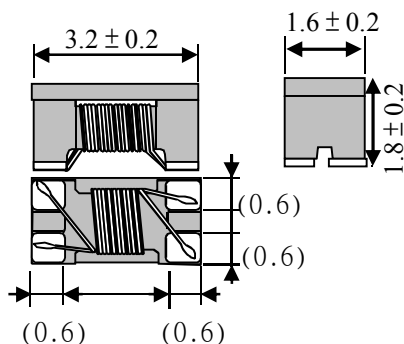

RECOMMENDED FOOTPRINT

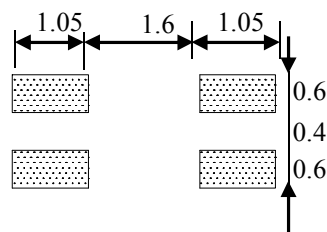

Unit:mm

ELECTRICAL CHARACTERISTICS

Our Product Part Number	Common-Mode Impedance Z(Ω) at 100MHz	DC Resistance Rdc(Ω)	Rated Current Idc(mA)	Rated Voltage Vdc(V)	Withstanding Voltage Vdc(V)	Insulation Resistance (MΩ)Min.
CMF3216F-750-2P-T	75 ±25%	0.30	500	50	125	10
CMF3216F-900-2P-T	90 ±25%	0.30	500	50	125	10
CMF3216F-121-2P-T	120 ±25%	0.30	370	50	125	10
CMF3216F-161-2P-T	160 ±25%	0.40	340	50	125	10
CMF3216F-181-2P-T	180 ±25%	0.40	340	50	125	10
CMF3216F-261-2P-T	260 ±25%	0.50	310	50	125	10
CMF3216F-431-2P-T	430 ±25%	0.60	280	50	125	10
CMF3216F-601-2P-T	600 ±25%	0.80	260	50	125	10
CMF3216F-102-2P-T	1000 ±25%	1.00	230	50	125	10
CMF3216F-222-2P-T	2200 ±25%	1.20	200	50	125	10

CMF3216F Series

Common Mode SMD Filter for Signal Line

Characteristics(Impedance vs. Frequency)

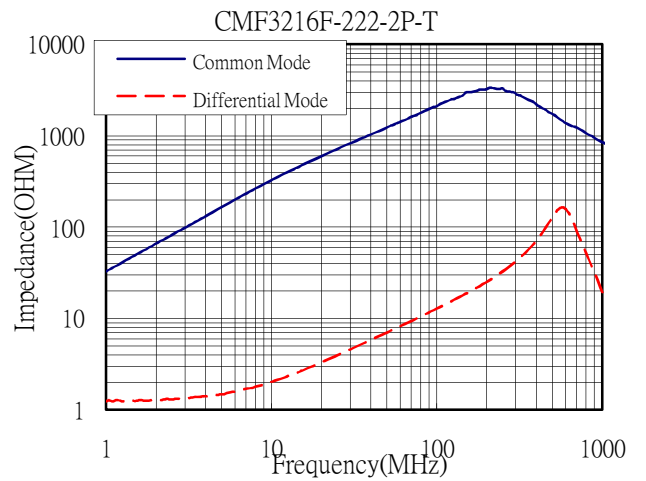
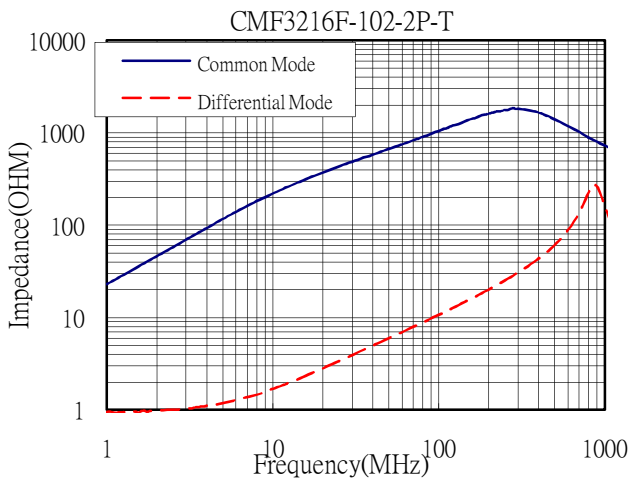
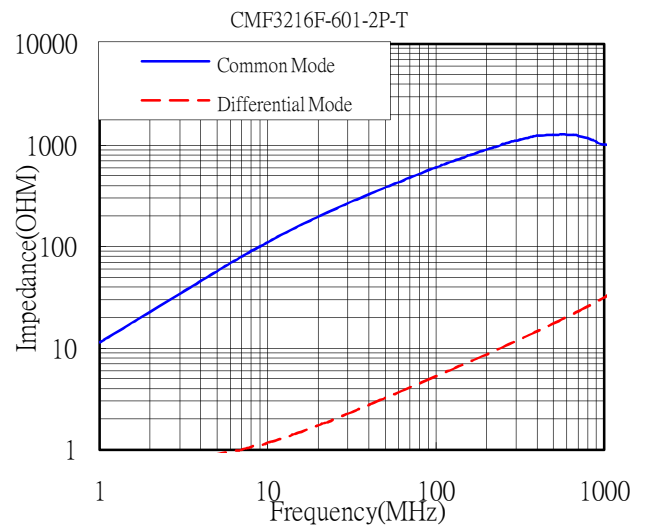
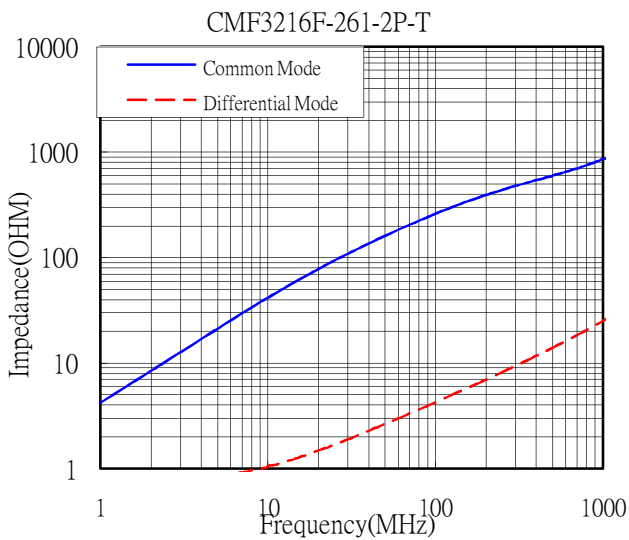
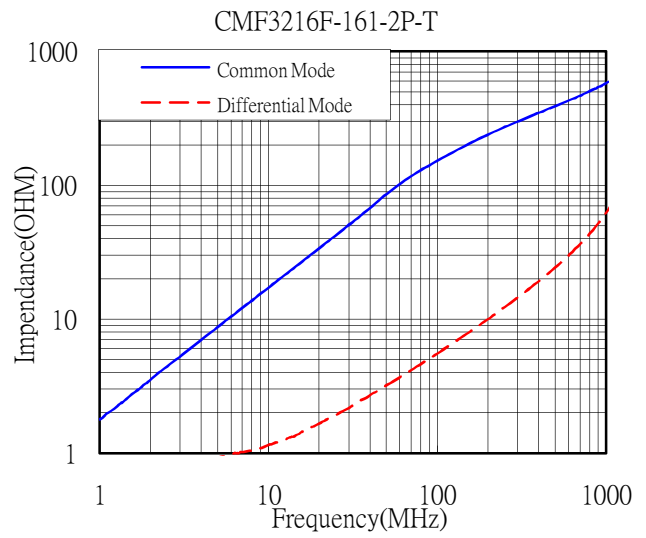
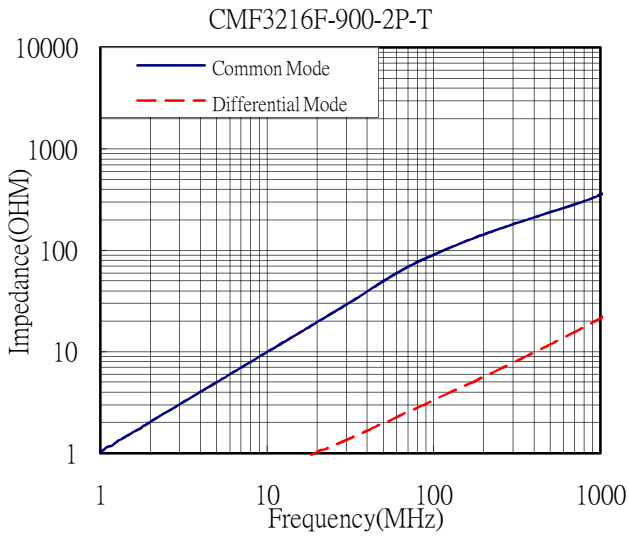

X-ON Electronics

Largest Supplier of Electrical and Electronic Components

Click to view similar products for [Common Mode Chokes / Filters](#) category:

Click to view products by [EMTEK](#) manufacturer:

Other Similar products are found below :

[74279408](#) [PE-62911NL](#) [PE-64683](#) [RD5122-6-9M6](#) [RGCMF1210900H3T](#) [ST6118T-R](#) [FE3X025-10-7NL](#) [T8114NLT](#) [RD5122-10-6M0](#)
[TCM0806G-350-2P-T](#) [TCM0806G-650-2P-T](#) [B2013FNLT](#) [IND-0110](#) [UAL21V07012500](#) [UAL21VR0802000](#) [UAL24VR06500CH](#)
[UALSC023000000](#) [UALSC1020JH000](#) [UALSC1520JH000](#) [UALSU10VR15019](#) [UALSU9HF060300](#) [UALSU9VD070100](#) [36-00037](#)
[5701610000](#) [UALW21HS200290](#) [UALW21HS072450](#) [UALSU9VD070400](#) [UALSU9HF050500](#) [UALSU9H0208000](#) [UAL24VK06450CH](#)
[PLT10HH401100PNB](#) [PLT10HH1026R0PNB](#) [PE-67531](#) [TLH10UB](#) [113 0R5](#) [2752045447](#) [CMS3-11-R](#) [7351V](#) [7408-RC](#) [CMF16-153131](#)
[744252510](#) [T8116NLT](#) [CMS2-10-R](#) [DLW44SN101SK2L](#) [FE2X10-4-2NL](#) [744253200](#) [744253101](#) [744252220](#) [TX8111NLT](#)
[UAL30VR3500470](#) [CTX01-19077-R](#)