

CMF3216F Series

Common Mode SMD Filter for Signal Line

FEATURES

- This common mode filter is characterized by its small sized
- Highly effective in noise suppression. High common-mode impedance at noise band and low differential-mode impedance at signal band.
- Due to the low differential-mode impedance with high coupling factor, there is almost no distortion on high speed signal.
- This series is micro-produced by auto machines for its huge productivity and accuracy with all-day CCD inspection.

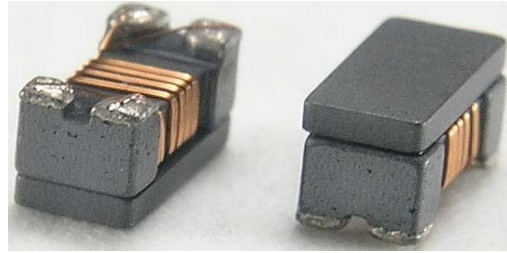

PRODUCT IDENTIFICATION

CMF 3216 F - 900 - 2P - T

(1) (2) (3) (4) (5) (6)

- (1) Product name
 (2) Shapes and Dimensions
 (3) Shielding type
 (4) Impedance[at 100MHz] 900:90Ω
 (5) Number of line 2P:2-Line
 (6) Taping style

APPLICATIONS

- Used for noise suppression in any electronic devices such as personal computer and periphera equipment (USB), amusement equipment (IEEE LCD panels (LVDS) etc.

SHAPES AND DIMENSIONS

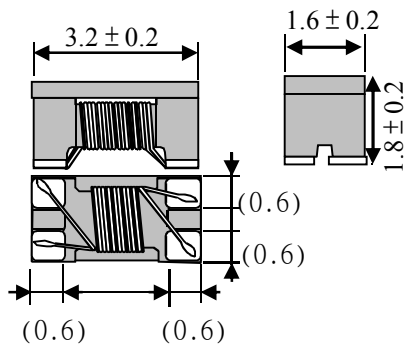

RECOMMENDED FOOTPRINT

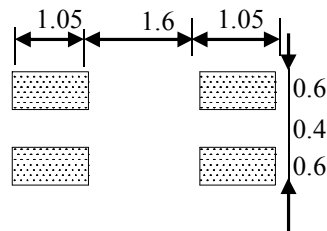

Unit:mm

ELECTRICAL CHARACTERISTICS

Our Product Part Number	Common-Mode Impedance Z(Ω) at 100MHz	DC Resistance Rdc(Ω)	Rated Current Idc(mA)	Rated Voltage Vdc(V)	Withstanding Voltage Vdc(V)	Insulation Resistance (MΩ)Min.
CMF3216F-750-2P-T	75 ±25%	0.30	500	50	125	10
CMF3216F-900-2P-T	90 ±25%	0.30	500	50	125	10
CMF3216F-121-2P-T	120 ±25%	0.30	370	50	125	10
CMF3216F-161-2P-T	160 ±25%	0.40	340	50	125	10
CMF3216F-181-2P-T	180 ±25%	0.40	340	50	125	10
CMF3216F-261-2P-T	260 ±25%	0.50	310	50	125	10
CMF3216F-431-2P-T	430 ±25%	0.60	280	50	125	10
CMF3216F-601-2P-T	600 ±25%	0.80	260	50	125	10
CMF3216F-102-2P-T	1000 ±25%	1.00	230	50	125	10
CMF3216F-222-2P-T	2200 ±25%	1.20	200	50	125	10

CMF3216F Series

Common Mode SMD Filter for Signal Line

Characteristics(Impedance vs. Frequency)

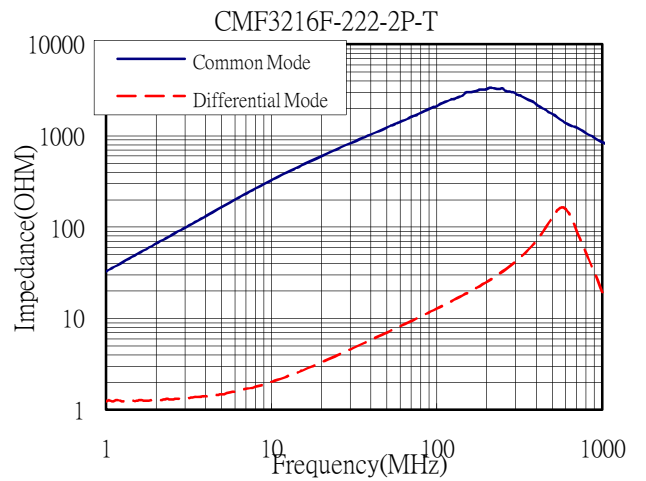
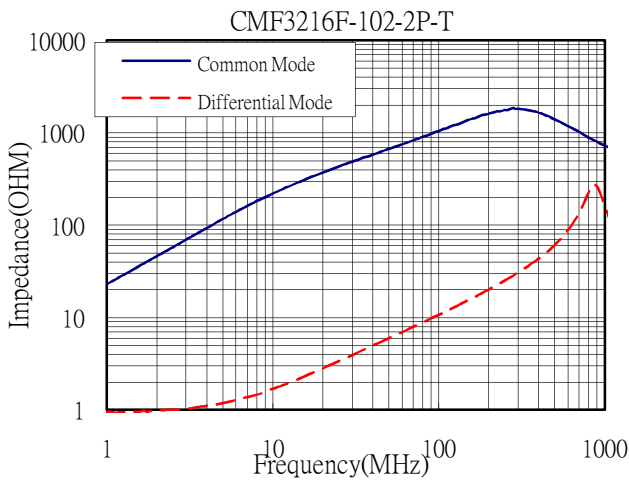
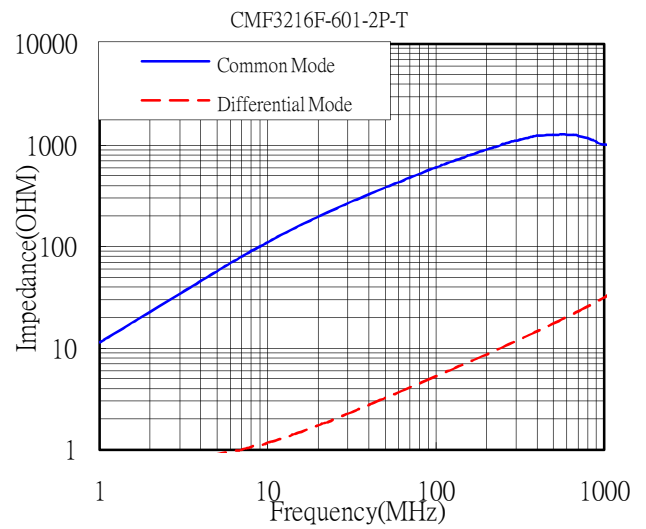
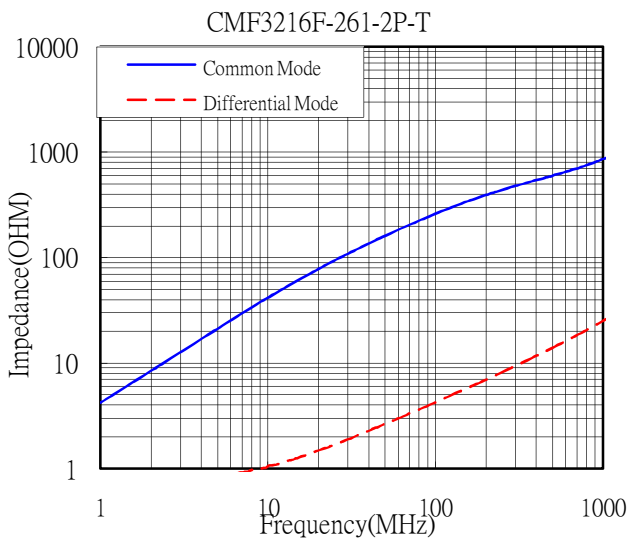
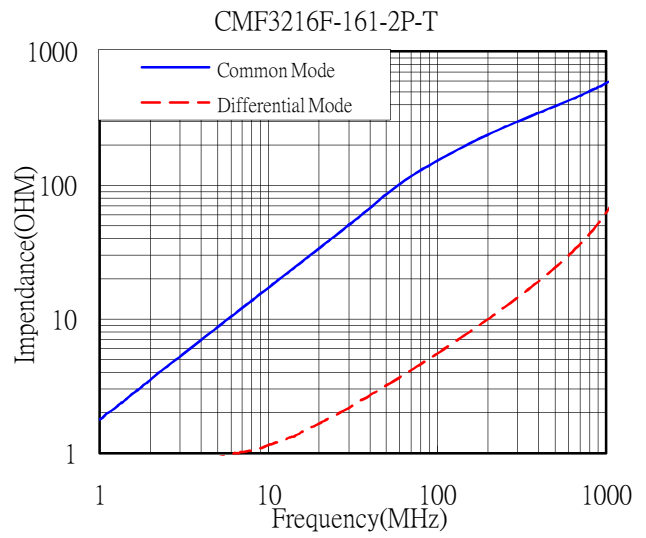
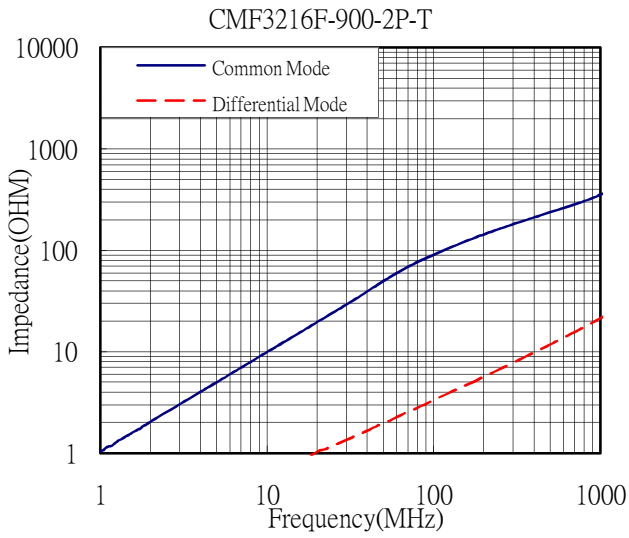

X-ON Electronics

Largest Supplier of Electrical and Electronic Components

Click to view similar products for [Common Mode Chokes / Filters](#) category:

Click to view products by [EMTEK](#) manufacturer:

Other Similar products are found below :

[RGCMF1210900H3T](#) [B82722A2102N001](#) [UAL21V07012500](#) [UAL24VR06500CH](#) [UALSC0220G0000](#) [UALSC058000000](#)
[UALSC0580J0000](#) [UALSC1520JH000](#) [UALSU10VR15019](#) [UALSU10VR20010](#) [UALSU16VD30030](#) [UALSU16VD40010](#)
[UALSU9H0305000](#) [UALSU9HF030600](#) [UALSU9HF060300](#) [UALSU9HR050340](#) [UALSU9VD070100](#) [UALSU9VR070170](#) [5701610000](#)
[CM7060M132R-10](#) [UALW21HS200290](#) [UALW21HS072450](#) [UALSU9VD070400](#) [UALSU9V0701000](#) [UALSU9HR030900](#)
[UALSU9HF050500](#) [UALSU9H0701000](#) [UALSU9H0208000](#) [UALSU9H0110000](#) [UALSCF25081300](#) [UALSC0305GS000](#)
[UALSC0120G0000](#) [UAL24VK06450CH](#) [UAL11VL1105000](#) [RN112-3.6-02-0M4](#) [RN114-1.2-02-10M](#) [RN122-0.6-02-47M](#) [RN122-3-02-4M5](#)
[RN142-1-02-33M](#) [RN214-2.5-02-3M3](#) [RN112-2-02-1M0](#) [RN143-6-02-1M8](#) [RN214-0.8-02-27M](#) [RN242-1.4-02-27M](#) [EXC-X4CH120X](#)
[DLW5BTM102TQ2L](#) [CMF16-153131](#) [CMF23H-273141](#) [744252510](#) [B82793C0253N201](#)