

PRODUCT SPECIFICATION

新弘智

SPEC. NO: T-0602-102D

DATE: Nov.27,2018

CUSTOMER'S PRODUCT NAME:

EMTEK PRODUCT NAME:

CMF4532F-Series

THIS SPECIFICATION IS:

- FULLY ACCEPTED
 DENIED
 ACCEPTED UNDER THE FOLLOWING CONDITIONS



SIGNATURE: _____ DATE: _____

NAME(PRINT): _____

TITLE: _____

 **EMTEK CO., LTD.**

本文件內容全部或部份,未經兆欣科技股份有限公司同意不得以任何形式複製或其他用途
All rights reserved.This document or parts thereof,may not be reproduced by any means or used in any manner without written permission of EMTEK CO.,LTD.

FACTORY:
39,Chingao Rd.,(305)Hsinpu,
Hsinchu Hsien,Taiwan,R.O.C
TEL: 03-5894-433
FAX: 03-5894-523

PRODUCT SPECIFICATION

SPEC. NO.

T-0602-102D



1. Scope

This specification applies ferrite Chip common mode filters CMF4532F-Series to be delivered to user.

2. Product Identification

CMF 4532 F - 601 - 2P - T
 (1) (2) (3) (4) (5) (6)

- (1) Product name
- (2) Shapes and dimensions
- (3) Application
- (4) Impedance 【 at 100MHz】
601:600Ω
- (5) Number of Line
2P:2-Line
- (6) Taping Type

3. Shapes and Dimensions [Dimensions in mm]

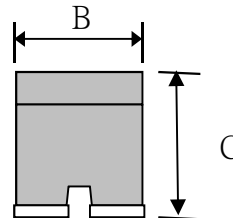
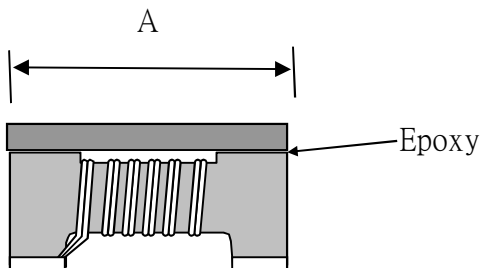

- A : 4.5 ± 0.2 mm
- B : 3.2 ± 0.2 mm
- C : 2.8 ± 0.2 mm
- D1 : 1.0 ± 0.1 mm
- D2 : 1.2 ± 0.1 mm

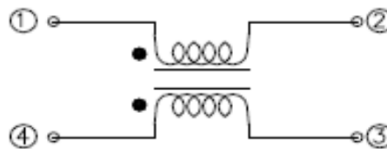
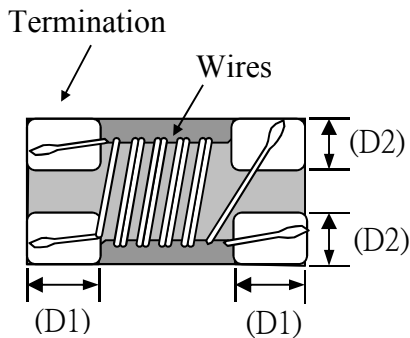

Drawn by	Checked by	Approved by
Cindy Jul. 20, 2016	Zhang Jul. 20, 2016	[Signature] Jul. 20, 2016

PRODUCT SPECIFICATION

SPEC. NO.

T-0602-102D



4. Electrical Characteristics

4-1 Electrical Spec.

Our Product Part Number	Common-Mode Impedance $Z(\Omega)$ at 100MHz	DC Resistance $R_{dc}(\Omega)$ Max.	Rated Voltage $V_{dc}(V)$	Insulation Resistance $(M\Omega)$ Min.	Withstand Voltage $V_{dc}(V)$	Rated Current $I_{dc}(mA)$ Max.
CMF4532F-601-2P-T	600±25%	0.24	50	10	125	1400
CMF4532F-801-2P-T	800±25%	0.26	50	10	125	1000
CMF4532F-102-2P-T	1000±25%	0.30	50	10	125	1000
CMF4532F-142-2P-T	1400±25%	0.4	50	10	125	1000
CMF4532F-252-2P-T	2500±25%	0.9	50	10	125	200

4-2 Characteristics(Reference)

4-2-1 Z v.s. Freq.

CMF4532F-601-2P-T

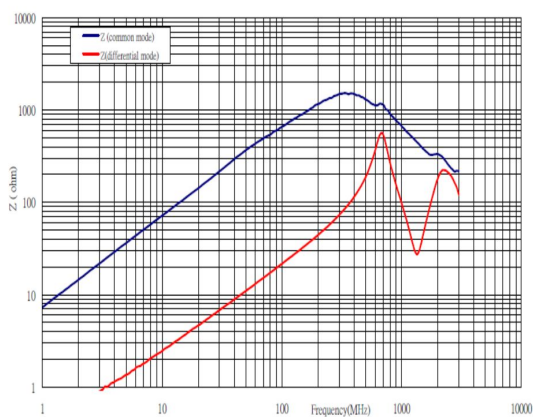

CMF4532F-801-2P-T

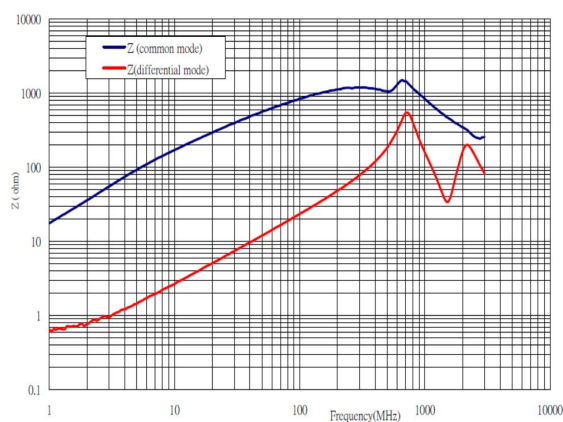

CMF4532F-142-2P-T

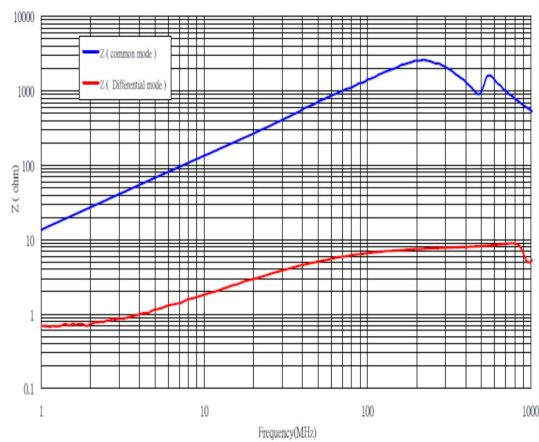

CMF4532F-252-2P-T

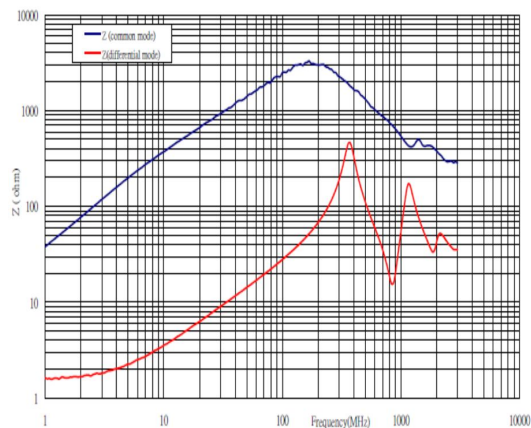

PRODUCT SPECIFICATION

SPEC. NO.

T-0602-102D



4-3 Test Equipment

4-3-1 Impedance

Measured by using Agilent E4991A RF Impedance Analyzer.

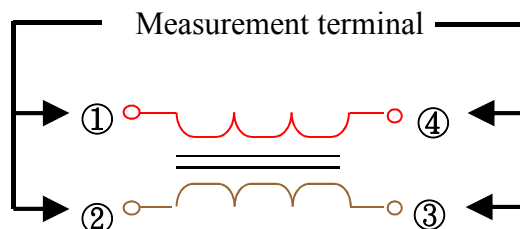

4-3-2 DC Resistance

Measured by using Chroma 16502 mill ohm meter.

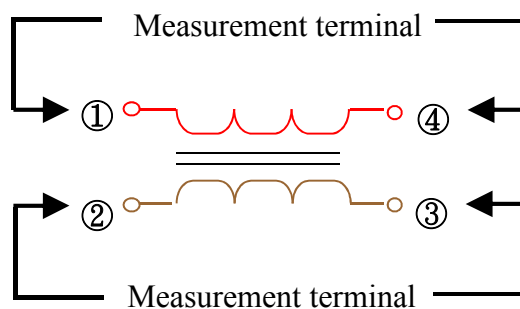

4-3-3 Insulation Resistance

Measured by using Chroma 19073

Measurement voltage : 50v .

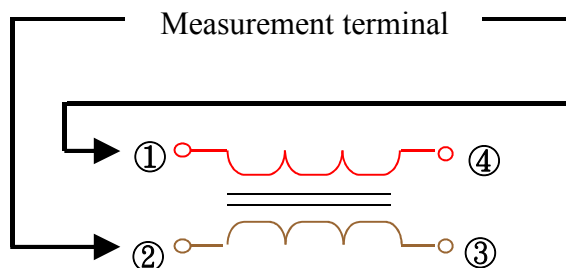

PRODUCT SPECIFICATION

SPEC. NO.

T-0602-102D

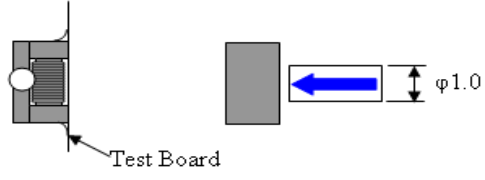
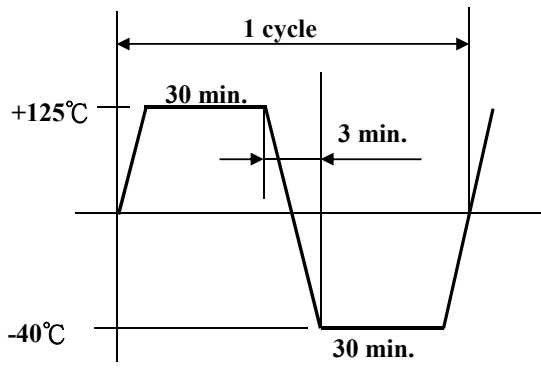

5. Reliability Test

Operating temperature : -40 to +125°C		Storage temp and humidity : 20~25°C ,60%RH max.
Item	Specifications	Test conditions
Solderability	It can be connected on the Recommendation soldering condition.	Apply cream solder to the test circuit board . It is mounted on the recommendation soldering condition. Dip pads in flux and dip in solder pot(96.5 Sn/3.5 Ag solder) at 255°C ±5°C.
Solder Heat Resistance	Components should have not evidence of electrical and mechanical damage Impedance: within ±15% of initial value	The device should be reflow soldered on PCB Preheating: 150°C , 60 secs Solder temperature: Peak 260±5°C for 10secs Solder Composition: 96.5Sn/3.5Ag
Terminal strength	The terminal electrode and the ferrite must not be damaged.	Solder a chip to test substrate , and then laterally apply a load 1.8Kg in the arrow direction. 
High temperature resistance	Appearance : Ferrite shall not be damaged. initial value.	Temperature : +125±2°C Testing time : 168±12 hours Measurement : After placing for 24 hours min.
Humidity resistance	insulation resistance: >10(MΩ) DC resistance : standard value inside.	Temperature : +60±2°C Humidity : 90 to 95%RH Testing time : 168±12 hours Measurement : After placing for 24 hours min.
Thermal cycle		Temperature : -40°C,+125°C kept stabilized for 30 minutes each. Cycle : 10 cycle Measurement : After placing for 24 hours min. 

PRODUCT SPECIFICATION

SPEC. NO.

T-0602-102D



Item	Specifications	Test conditions
Low temperature resistance	Appearance : Ferrite shall not be damaged. initial value. insulation resistance: >10(MΩ) DC resistance : standard value inside.	Temperature : $-40\pm 2^{\circ}\text{C}$ Testing time : 168 ± 12 hours Measurement : After placing for 24 hours min.

6.Packaging

The packaging must be done not to receive any damage during transporting and storing

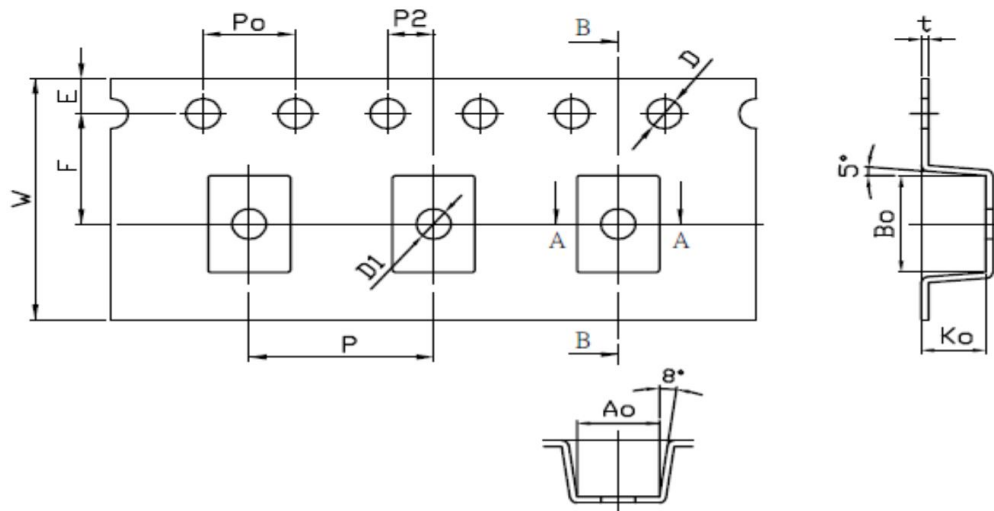

(Dimensions in mm)

Symbol	W	P	E	F	P2	D	D1	Po	10Po	Ao	Bo	Ko	t
Dimension	12.00	8.00	1.75	5.50	2.00	1.50	1.50	4.00	40.00	3.57	4.80	2.80	0.30
SPEC.	± 0.1	± 0.1	± 0.1	± 0.05	± 0.05	$+0.10$ -0.00	± 0.1	± 0.1	± 0.2	± 0.1	± 0.1	± 0.1	± 0.05

PRODUCT SPECIFICATION

SPEC. NO.

T-0602-102D



6-2 Reel dimensions

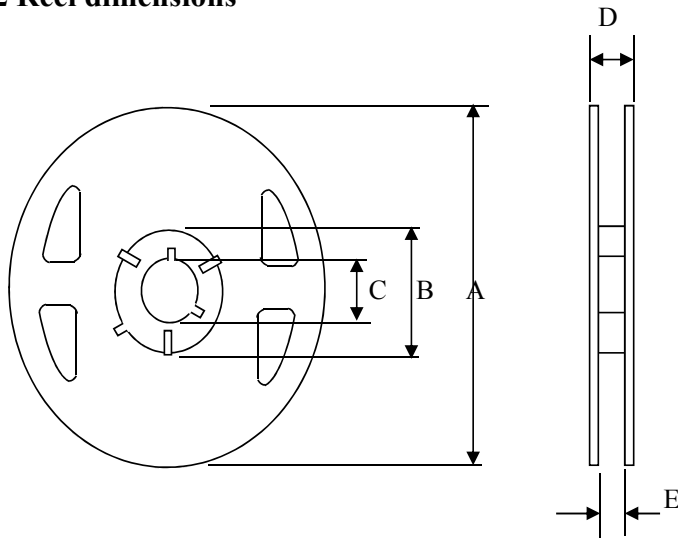

(Dimensions in mm)

Symbol	T
A	180
B	60
C	13
D	16
E	13.2

6-3 Tapping figure

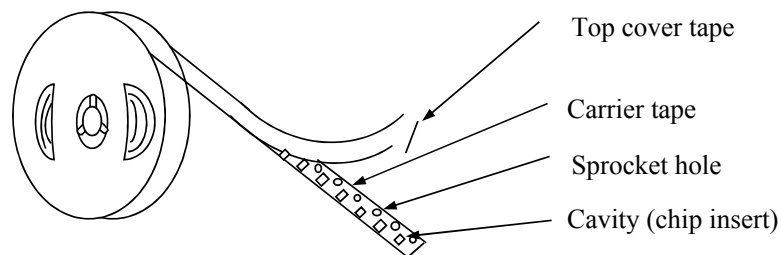

6-4 Packaging Form

There shall not continuation more than two vacancies of the product.

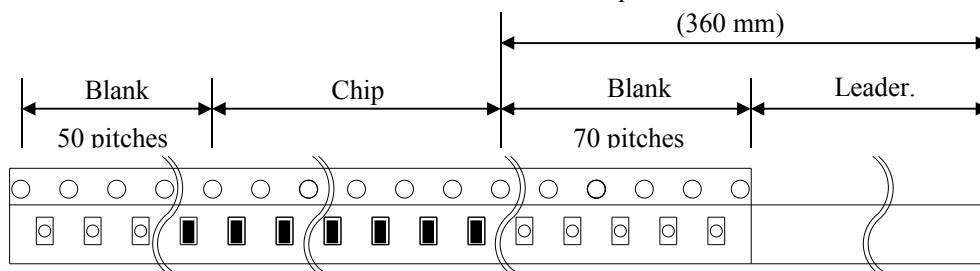

Material of carrier tape : Polystyrene

Material of cover tape : Polyester

PRODUCT SPECIFICATION

6-5 Cover Tape Peel Strength

The force for tearing off cover tape is 0.05~0.69(N) in the arrow direction at the following conditions:

Temperature : 5 ~ 35°C

Humidity : 45 ~ 85%

Atmospheric pressure : 860 ~ 1060 hpa

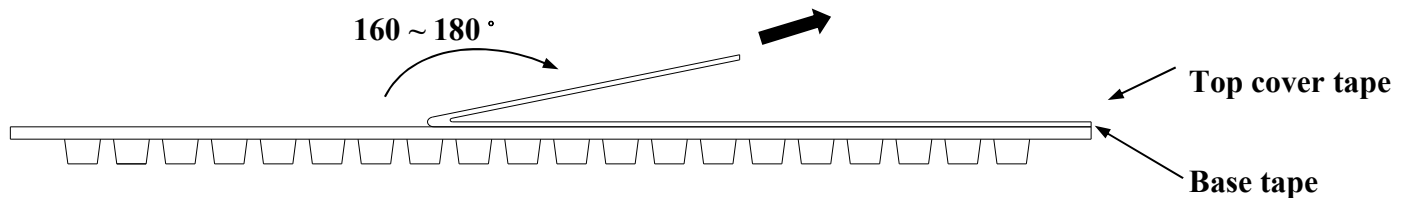

6-6 Packing Quantity

φ180 mm reel T type : 500 pcs./reel

7. Recommended Soldering Conditions (Please use this product by reflow soldering)

7-1 Recommended Footprint

Termination Number : Please refer to the equivalent circuit in chapter 3.

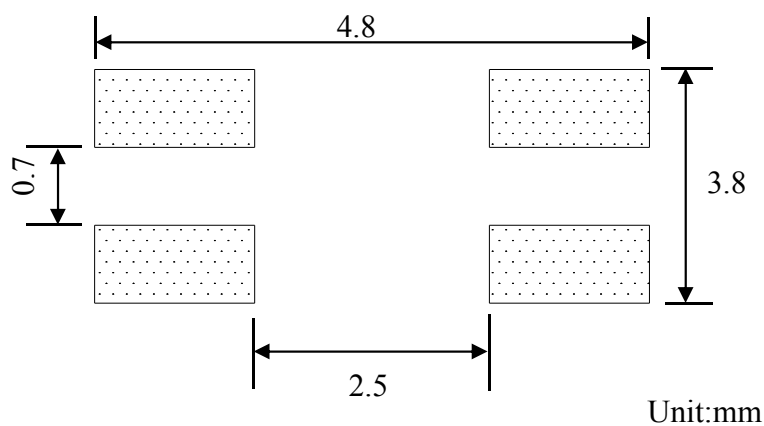

PRODUCT SPECIFICATION

SPEC. NO.

T-0602-102D



7-2 Recommended Reflow Pattern

Reflow : until two times

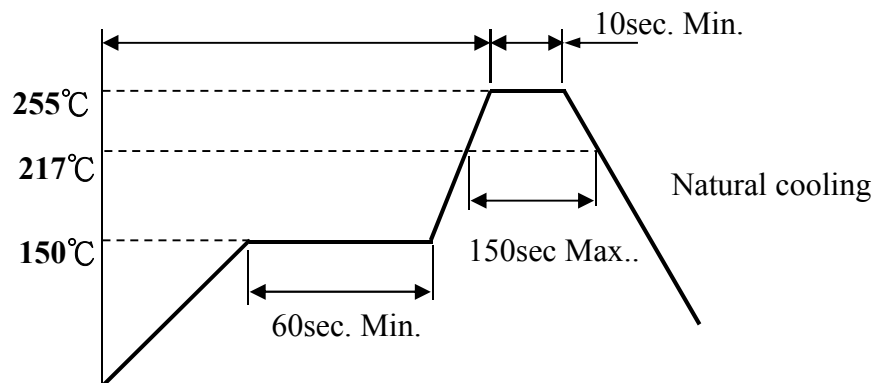

7-3 Iron Soldering

Use a solder iron of less than 30W when soldering, do not allow the soldering iron tip directly touch the ferrite body outside of terminal electrode.

5 seconds max. at 260°C.

8. Attention in Case of Using

In case of using product, please avoid following matters:

Splashing water or salt water

Dew condenses

Toxic gas (Hydrogen sulfide, Sulfurous acid, Chlorine, Ammonia)

Vibrations or shocks which exceed the specified condition

Please be careful for the stress to this product by board flexure or something after the mounting.

9. Others

9-1 Operating temperature range : -40~+125°C

9-2 Storage condition : Temperature 20~25°C, Relative Humidity 40% ~ 60%

9-3 Recommended wire wound inductors should be used within 6 months from the time of delivery.

X-ON Electronics

Largest Supplier of Electrical and Electronic Components

Click to view similar products for [Common Mode Chokes / Filters](#) category:

Click to view products by [EMTEK](#) manufacturer:

Other Similar products are found below :

[74279408](#) [PE-62911NL](#) [PE-64683](#) [RD5122-6-9M6](#) [RGCMF1210900H3T](#) [ST6118T-R](#) [FE3X025-10-7NL](#) [T8114NLT](#) [RD5122-10-6M0](#)
[TCM0806G-350-2P-T](#) [TCM0806G-650-2P-T](#) [B2013FNLT](#) [IND-0110](#) [UAL21VR0802000](#) [UALSC023000000](#) [UALSC1020JH000](#)
[UALSC1520JH000](#) [UALSU10VR15019](#) [UALSU9VD070100](#) [36-00037](#) [5701610000](#) [UALW21HS200290](#) [UALW21HS072450](#)
[UALSU9HF050500](#) [UALSU9H0208000](#) [UAL24VK06450CH](#) [PLT10HH401100PNB](#) [PLT10HH1026R0PNB](#) [PE-67531](#) [TLH10UB](#) [113 OR5](#)
[2752045447](#) [CMS3-11-R](#) [7351V](#) [7408-RC](#) [CMF16-153131](#) [744252510](#) [T8116NLT](#) [CMS2-10-R](#) [DLW44SN101SK2L](#) [FE2X10-4-2NL](#)
[744253200](#) [744253101](#) [744252220](#) [TX8111NLT](#) [UAL30VR3500470](#) [CTX01-19077-R](#) [T8003NLT](#) [CTX01-13663](#) [CTX66-19521-R](#)
[7446630047](#)