

PRODUCT SPECIFICATION

SPEC. NO: T-0619-001h

DATE: Aug. 21, 2018

CUSTOMER'S PRODUCT NAME:

EMTEK PRODUCT NAME:

HSC0805-SERIES

THIS SPECIFICATION IS:

- FULLY ACCEPTED
- DENIED
- ACCEPTED UNDER THE FOLLOWING CONDITIONS



SIGNATURE: _____

DATE: _____

NAME(PRINT): _____

TITLE: _____

 **EMTEK CO., LTD.**

本文件內容全部或部份,未經兆欣科技股份有限公司同意不得以任何形式複製或其他用途
All rights reserved.This document or parts thereof,may not be reproduced by any means or used in any manner without written permission of EMTEK CO.,LTD.

FACTORY:

39, Chingao Rd., (305)Hsinpu,
Hsinchu Hsien, Taiwan, R. O. C
TEL: 03-5894-433
FAX: 03-5894-523

PRODUCT SPECIFICATION

SPEC. NO.

T-0619-001h



1. Scope

This specification applies Wire Wound Ceramic Chip Inductor HSC0805-Series to be delivered to user.

2. Product Identification

HSC 0805 - 10N □ - T

(1) (2) (3) (4) (5)

- (1) Product name
- (2) Shapes and dimensions
- (3) Inductance
10N : 10 nH
- (4) Tolerance
G=±2% , J=±5% , K=±10%
- (5) Taping Type

3. Shapes and Dimensions

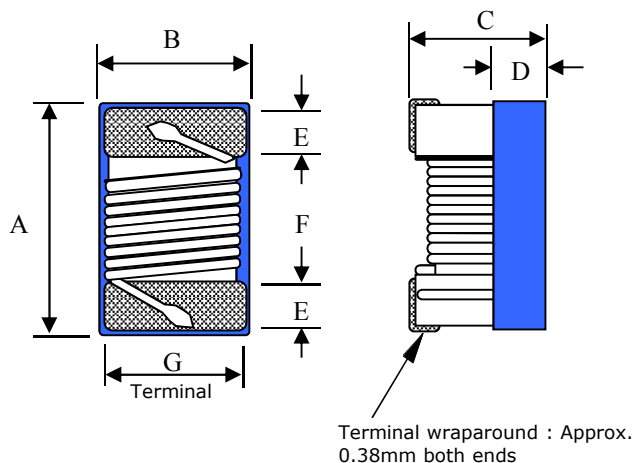

A max. :	2.40 mm
B max. :	1.65 mm
C max. :	1.45 mm
D ref. :	0.65 mm
E :	0.44 ± 0.1 mm
F :	1.15 ± 0.1 mm
G :	1.27 mm

Equivalent circuit

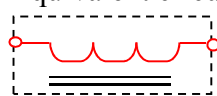

No Polarity



Drawn by	Checked by	Approved by
Cindy Aug.12.2016	Zheng Aug.12.2016	Su Aug.12.2016

PRODUCT SPECIFICATION

SPEC. NO.

T-0619-001h

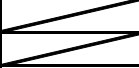
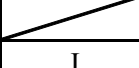
**4. Electrical Characteristics**

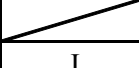
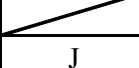
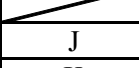
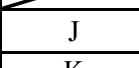
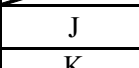
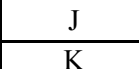
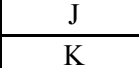
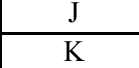
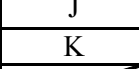
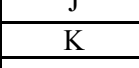
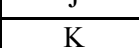
Customer Part Number	Our Product Part Number	Inductance (nH)/MHz	Inductance Tolerance	Q/MHz Min.	SRF(Min.) (MHz)	Rdc (Ω)Max.	Irms Max. (mA)	Color Coding
	HSC0805-2N2□-T	2.2/250	 K	50/1000	7900	0.05	800	Violet
	HSC0805-2N7□-T	2.7/250	 J K	50/1500	7900	0.058	800	Blue
	HSC0805-2N8□-T	2.8/250	 J K	55/1500	7900	0.06	800	Gray
	HSC0805-3N0□-T	3.0/250	 J K	55/1500	7900	0.08	800	White
	HSC0805-3N3□-T	3.3/250	 J K	45/1500	7900	0.12	600	Black
	HSC0805-4N1□-T	4.1/250	 J K	60/1000	5800	0.06	600	Brown
	HSC0805-5N1□-T	5.1/250	 J K	60/1000	5800	0.06	600	Yellow
	HSC0805-5N6□-T	5.6/250	 J K	65/1000	5500	0.08	600	Orange
	HSC0805-6N2□-T	6.2/250	 J K	50/1000	5500	0.11	800	Violet
	HSC0805-6N8□-T	6.8/250	 J K	50/1000	5500	0.11	600	Brown
	HSC0805-7N5□-T	7.5/250	 J K	50/1000	4500	0.14	600	Green
	HSC0805-8N2□-T	8.2/250	 J K	50/1000	4700	0.16	600	Red
	HSC0805-8N7□-T	8.7/250	 J K	50/1000	4700	0.23	600	Violet
	HSC0805-10N□-T	10/250	 G J K	60/500	4200	0.10	600	Blue



PRODUCT SPECIFICATION

SPEC. NO.

T-0619-001h

Customer Part Number	Our Product Part Number	Inductance (nH)/MHz	Inductance Tolerance	Q/MHz Min.	SRF(Min.) (MHz)	Rdc (Ω)Max.	Irms Max. (mA)	Color Coding
	HSC0805-12N□-T	12/250	G	50/500	4000	0.15	600	Orange
			J					
			K					
	HSC0805-14N□-T	14/250	G	50/500	3400	0.17	600	Yellow
			J					
			K					
	HSC0805-15N□-T	15/250	G	50/500	3400	0.17	700	Yellow
			J					
			K					
	HSC0805-16N□-T	16/250	G	50/500	3300	0.19	600	Green
			J					
			K					
	HSC0805-18N□-T	18/250	G	50/500	3300	0.20	600	Green
			J					
			K					
	HSC0805-22N□-T	22/250	G	55/500	2600	0.22	500	Blue
			J					
			K					
	HSC0805-24N□-T	24/250	G	50/500	2000	0.22	500	Gray
			J					
			K					
	HSC0805-27N□-T	27/250	G	55/500	2500	0.25	500	Violet
			J					
			K					
	HSC0805-33N□-T	33/250	G	60/500	2050	0.27	500	Gray
			J					
			K					
	HSC0805-36N□-T	36/250	G	55/500	1700	0.27	500	Orange
			J					
			K					
	HSC0805-39N□-T	39/250	G	60/500	2000	0.29	500	White
			J					
			K					
	HSC0805-43N□-T	43/200	G	60/500	1650	0.34	500	Yellow
			J					
			K					
	HSC0805-47N□-T	47/200	G	60/500	1650	0.31	700	Black
			J					
			K					

PRODUCT SPECIFICATION**SPEC. NO.**

T-0619-001h



Customer Part Number	Our Product Part Number	Inductance (nH)/MHz	Inductance Tolerance	Q/MHz Min.	SRF(Min.) (MHz)	Rdc (Ω)Max.	Irms Max. (mA)	Color Coding
	HSC0805-50N□-T	50/200	G	60/500	1650	0.34	500	Green
			J					
			K					
	HSC0805-56N□-T	56/200	G	60/500	1550	0.34	500	Brown
			J					
			K					
	HSC0805-68N□-T	68/200	G	60/500	1450	0.38	500	Red
			J					
			K					
	HSC0805-72N□-T	72/200	G	60/500	1400	0.40	400	Orange
			J					
			K					
	HSC0805-75N□-T	75/200	G	60/500	1400	0.40	400	Violet
			J					
			K					
	HSC0805-82N□-T	82/150	G	65/500	1300	0.42	400	Orange
			J					
			K					
	HSC0805-91N□-T	91/150	G	65/500	1200	0.48	400	Black
			J					
			K					
	HSC0805-R10□-T	100/150	G	65/500	1200	0.46	400	Yellow
			J					
			K					
	HSC0805-R11□-T	110/150	G	50/250	1000	0.48	400	Brown
			J					
			K					
	HSC0805-R12□-T	120/150	G	50/250	1100	0.51	400	Green
			J					
			K					
	HSC0805-R13□-T	130/150	G	50/250	1000	0.55	400	Orange
			J					
			K					
	HSC0805-R15□-T	150/100	G	50/250	920	0.56	400	Blue
			J					
			K					
	HSC0805-R16□-T	160/100	G	50/250	900	0.60	400	Gray
			J					
			K					
	HSC0805-R18□-T	180/100	G	50/250	870	0.64	400	Violet
			J					
			K					
	HSC0805-R20□-T	200/100	G	50/250	865	0.68	400	Red
			J					
			K					

PRODUCT SPECIFICATION**SPEC. NO.**

T-0619-001h



Customer Part Number	Our Product Part Number	Inductance (nH)/MHz	Inductance Tolerance	Q/MHz Min.	SRF(Min.) (MHz)	Rdc (Ω)Max.	Irms Max. (mA)	Color Coding
	HSC0805-R22□-T	220/100	G	50/250	850	0.70	400	Gray
			J					
			K					
	HSC0805-R24□-T	240/100	G	44/250	690	1.00	350	Red
			J					
			K					
	HSC0805-R25□-T	250/100	G	48/250	680	1.00	350	Yellow
			J					
			K					
	HSC0805-R27□-T	270/100	G	48/250	650	1.00	350	White
			J					
			K					
	HSC0805-R30□-T	300/100	G	48/250	790	1.40	330	Green
			J					
			K					
	HSC0805-R33□-T	330/100	G	48/250	750	1.40	310	Black
			J					
			K					
	HSC0805-R36□-T	360/100	G	48/250	650	1.45	300	Orange
			J					
			K					
	HSC0805-R39□-T	390/100	G	48/250	560	1.50	290	Brown
			J					
			K					
	HSC0805-R43□-T	430/50	G	33/100	430	1.70	270	Blue
			J					
			K					
	HSC0805-R47□-T	470/50	G	30/100	375	1.76	250	Violet
			J					
			K					
	HSC0805-R56□-T	560/25	G	23/50	340	1.90	230	Orange
			J					
			K					
	HSC0805-R62□-T	620/25	G	23/50	220	2.20	210	White
			J					
			K					
	HSC0805-R68□-T	680/25	G	23/50	188	2.20	190	Green
			J					
			K					



PRODUCT SPECIFICATION

SPEC. NO.

T-0619-001h

Customer Part Number	Our Product Part Number	Inductance (nH)/MHz	Inductance Tolerance	Q/MHz Min.	SRF(Min.) (MHz)	Rdc (Ω)Max.	Irms Max. (mA)	Color Coding
	HSC0805-R75□-T	750/25	G	23/50	200	2.30	180	Violet
			J					
			K					
	HSC0805-R82□-T	820/25	G	23/50	215	2.35	180	Blue
			J					
			K					
	HSC0805-R88□-T	880/25	G	22/50	212	2.38	180	Green
			J					
			K					
	HSC0805-R91□-T	910/25	/	22/50	210	2.40	180	Yellow
			J					
			K					
	HSC0805-R93□-T	930/25	G	22/50	200	2.45	180	Green
			J					
			K					
	HSC0805-1R0□-T	1000/25	G	22/50	200	2.45	180	Violet
			J					
			K					
	HSC0805-1R2□-T	1200/7.9	G	16/7.9	160	2.45	170	Green
			J					
			K					
	HSC0805-1R5□-T	1500/7.9	G	16/7.9	120	2.50	170	Black
			J					
			K					
	HSC0805-1R8□-T	1800/7.9	G	16/7.9	80	2.50	170	Brown
			J					
			K					
	HSC0805-2R2□-T	2200/7.9	G	16/7.9	60	2.70	160	Red
			J					
			K					
	HSC0805-2R7□-T	2700/7.9	G	16/7.9	50	4.00	160	Orange
			J					
			K					
	HSC0805-4R7□-T	4700/7.9	/	10/7.9	40	15	130	Yellow
			J					
			K					

PRODUCT SPECIFICATION

SPEC. NO.

T-0619-001h



1. When ordering, please specify tolerance and packaging codes. Ex: HSC0805-1R0J-T

Tolerance : G = $\pm 2\%$, J = $\pm 5\%$, K = $\pm 10\%$

Packaging : Clear tape and reel { standard }.

2. L , Q · SRF : Agilent/HP E4991A+ Agilent/HP16197A

(The electrical specification test by the smallest gap position) or HP16193A

3. Rdc : DIGITAL MILLIOHM METER Chroma 16502, or equivalent.

4. Irms for a 15°C rise above 25°C ambient.

5. Operating temperature range from -40°C to 125°C.

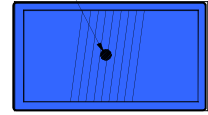
1st**COLOR CODING**

PRODUCT SPECIFICATION

SPEC. NO.

T-0619-001h

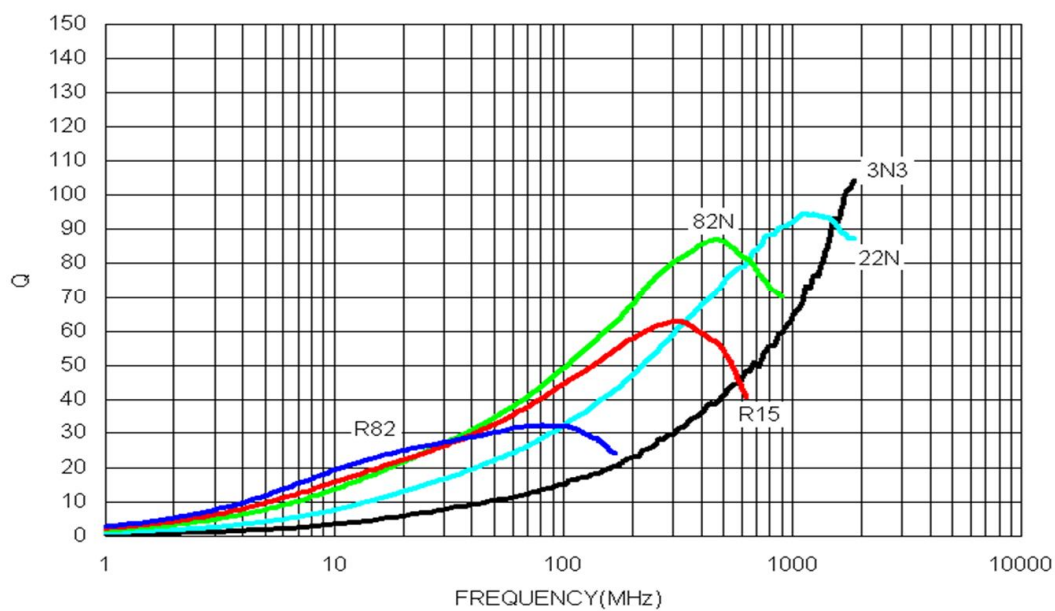
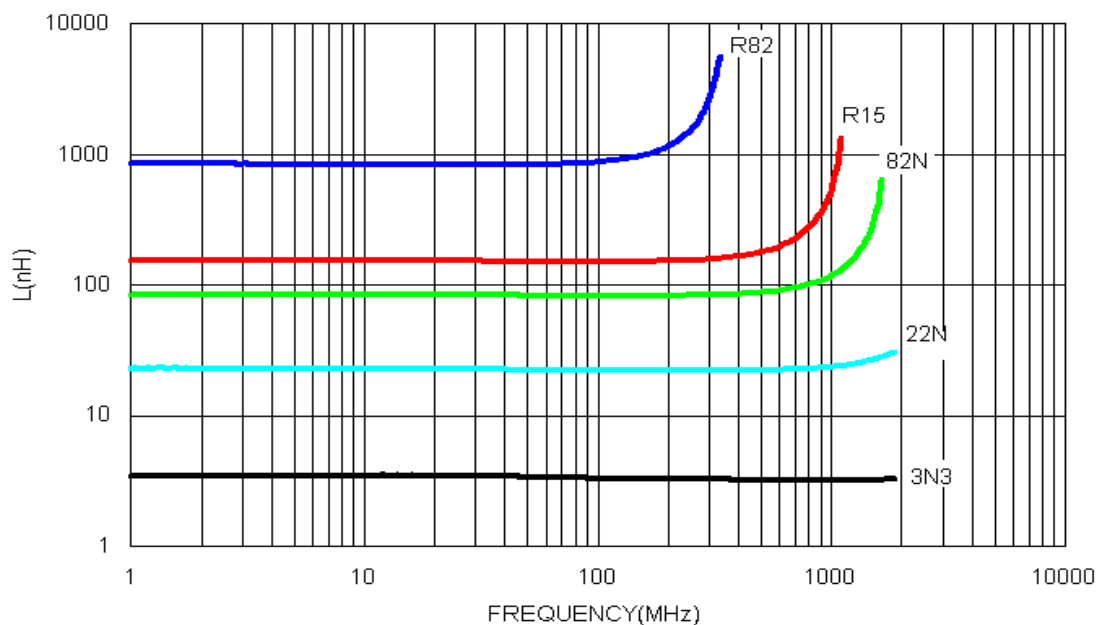

5. Material list

Item	Material
Core	Al203 96%
Wire	Copper wire
Epoxy	UV Epoxy

PRODUCT SPECIFICATION

SPEC. NO.

T-0619-001h

**6. Reliability Test**

Item	Specifications	Test conditions
Solderability	The metalized area must have 90% minimum solder coverage.	Dip pads in flux and dip in solder pot(96.5 Sn/3.5 Ag solder) at 255°C ±5°C.
Resistance to soldering heat	There must be no case deformation or change in dimensions. Inductance must not change more than the stated tolerance.	Inductors shall be reflowed onto a PC board using 96.5 Sn/3.5 Ag solder paste. Solder process shall be at a maximum temperature of 260°C. For 96.5 Sn/3.5 Ag solder paste:>217°C for 90 seconds
Vibration	There must be no case deformation or change in dimensions. Inductance must not change more than the stated tolerance.	Solder specimen inductor on the test printed circuit board. Apply vibrations in each of the x,y and z directions for 2 hours for a total of 6 hours. Frequency : 10~50 Hz Amplitude : 1.5mm
High temperature resistance	There must be no case deformation or change in dimensions. Inductance must not change more than the stated tolerance.	Inductors shall be subjected to temperature 125±2°C for 500±12 hours. Measure the test items after leaving the inductors at room temperature and humidity for 2 hours.
Static Humidity	Inductors must not have a shorted or openwinding.	Inductors shall be subjected to temperature 85±2°C and 90 to 95%RH. for ten 24-hours. Measure the test items after leaving the inductors at room temperature and humidity for 2 hours.
Component adhesion (push test)	Inductors shall be subjected to 1.8Kg	Inductors shall be reflow soldered (255°C ±5°C for 10 seconds) to a tinned copper substrate. A force gauge shall be applied to the side of the component. The device must withstand the stated force without a failure of the termination.

PRODUCT SPECIFICATION

SPEC. NO.

T-0619-001h

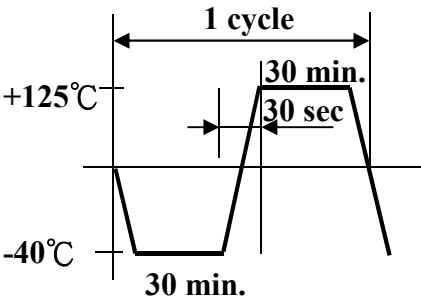

Item	Specifications	Test conditions
Low temperature resistance	There must be no case deformation or change in dimensions. Inductance must not change more than the stated tolerance.	Inductors shall be subjected to temperature $-40\pm 2^{\circ}\text{C}$ for 500 ± 12 hours. Measure the test items after leaving the inductors at room temperature and humidity for 1 to 2 hours.
Resistance to solvent	There must be no case deformation, change in dimensions, or obliteration of marking.	Inductors must withstand 6 minutes of alcohol or water.
Thermal shock	There must be no case deformation or change in dimensions. Inductance must not change more than the stated tolerance.	Inductors shall be subjected to 10 cycles to the following temperature cycle: <div style="text-align: center;">  </div> Measure the test items after leaving the inductors at room temperature and humidity for 2 hours.

PRODUCT SPECIFICATION

SPEC. NO.

T-0619-001h



7. Packaging

The packaging must be done not to receive any damage during transporting and storing.

7-1 Tape dimensions

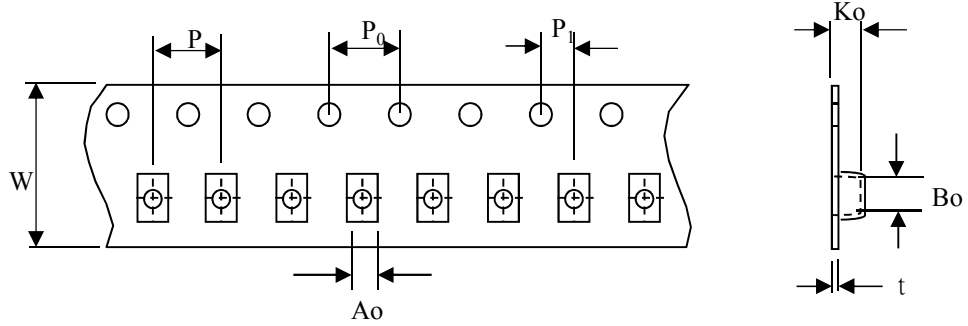

(Dimensions in mm; Tolerance : ±0.1)

Symbol	W	P	P ₀	P ₁	Ao	Bo	Ko	t
Dimension	8	4	4	2	1.57	2.28	1.4	0.22

7-2 Reel dimensions

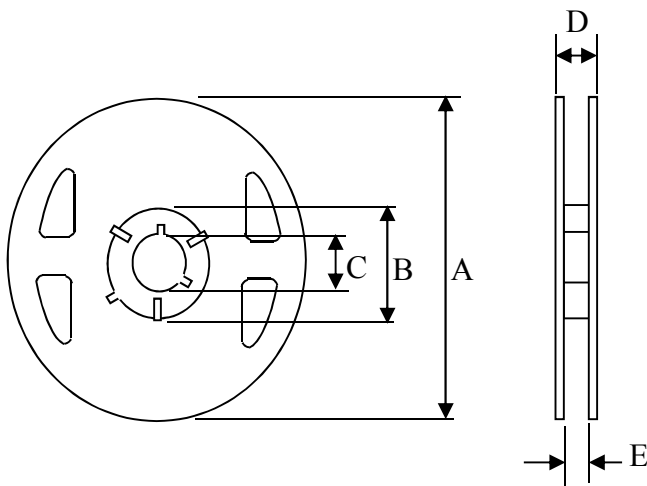

(Dimensions in mm)

Symbol	T
A	180
B	60
C	13
D	14.4
E	8.4

7-3 Tapping figure

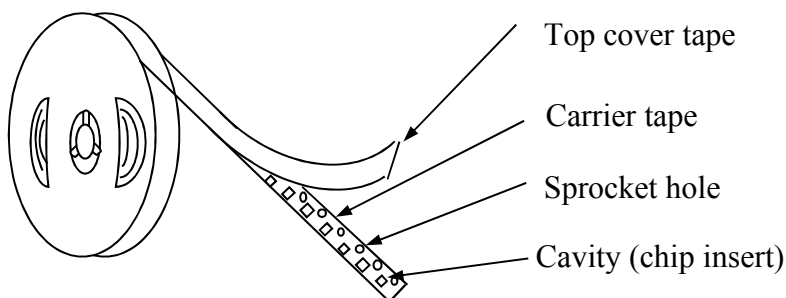

PRODUCT SPECIFICATION

SPEC. NO.

T-0619-001h



7-4 Packaging Form

There shall not continuation more than two vacancies of the product.

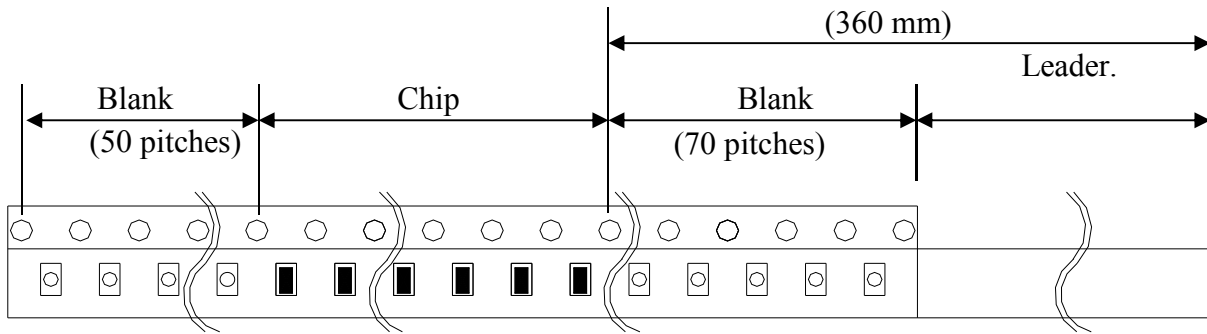

7-5 Cover Tape Peel Strength

The force for tearing off cover tape is 0.1~0.6(N) in the arrow direction at the following conditions:

Temperature : 5 ~ 35°C

Humidity : 45 ~ 85%

Atmospheric pressure : 860 ~ 1060 hpa

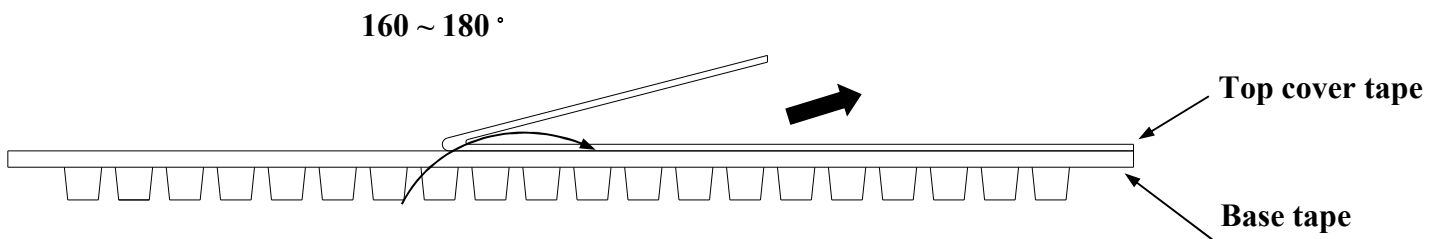

7-6 Packing Quantity

φ180 mm reel type : 2,000 pcs./reel

PRODUCT SPECIFICATION

SPEC. NO.

T-0619-001h



8. Recommended Soldering Conditions

(Please use this product by reflow soldering)

8-1 Recommended Footprint

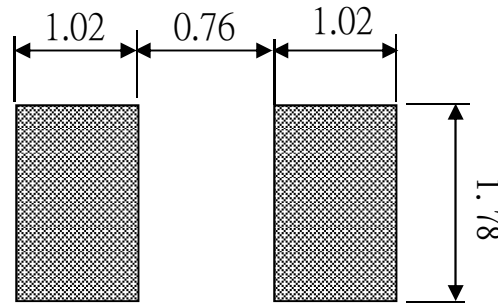

Unit: mm

8-2 Recommended Reflow Pattern

Reflow : until two times

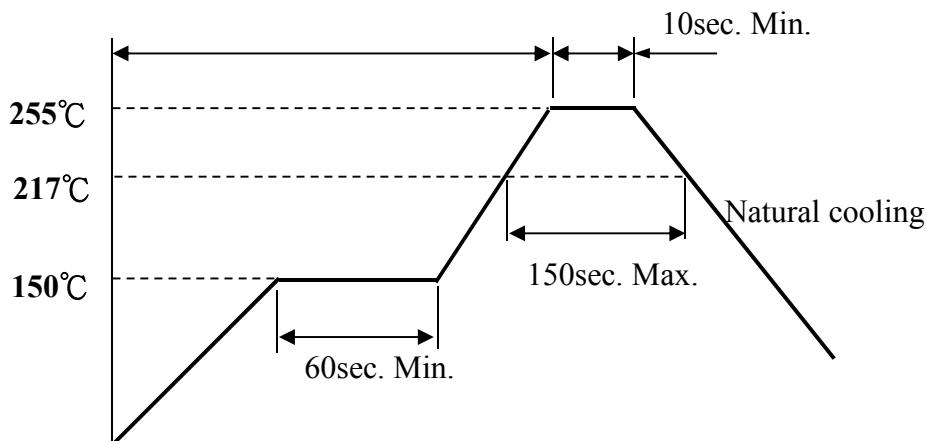

8-3 Iron Soldering

Use a solder iron of less than 30W when soldering ,do not allow the soldering iron to directly touch the Ceramic body outside of terminal electrode.

5 seconds max. at 260°C.

9. Attention in Case of Using

In case of using product ,please avoid following matters:

Splashing water or salt water

Dew condens

Toxic gas (Hydrogen sulfide, Sulfurous acid ,Chlorine, Ammonia)

Vibrations or shocks which exceed the specified condition

Please be careful for the stress to this product by board flexure or something after the mounting.

10. Others

10-1 Operating temperature range : Ceramic Series :-40~+125°C

10-2 Storage condition : Temperature 20°~25°C , Relative Humidity 40%~60%

10-3 Recommended wire wound inductors should be used within 6 months from the time of delivery.

X-ON Electronics

Largest Supplier of Electrical and Electronic Components

Click to view similar products for [Fixed Inductors](#) category:

Click to view products by [EMTEK](#) manufacturer:

Other Similar products are found below :

[CR32NP-100KC](#) [CR32NP-151KC](#) [CR32NP-180KC](#) [CR32NP-181KC](#) [CR32NP-1R5MC](#) [CR32NP-390KC](#) [CR32NP-3R9MC](#) [CR32NP-680KC](#) [CR32NP-820KC](#) [CR32NP-8R2MC](#) [CR43NP-390KC](#) [CR43NP-560KC](#) [CR43NP-680KC](#) [CR54NP-181KC](#) [CR54NP-470LC](#) [CR54NP-820KC](#) [CR54NP-8R5MC](#) [70F224AI](#) [MGDQ4-00004-P](#) [MHL1ECTTP18NJ](#) [MHQ1005P10NJ](#) [MHQ1005P1N0S](#) [MHQ1005P2N4S](#) [MHQ1005P3N6S](#) [MHQ1005P5N1S](#) [MHQ1005P8N2J](#) [PE-51506NL](#) [PE-53601NL](#) [PE-53602NL](#) [PE-53630NL](#) [PE-53824SNLT](#) [PE-92100NL](#) [PG0434.801NLT](#) [PG0936.113NLT](#) [9220-20](#) [9310-16](#) [PM06-2N7](#) [PM06-39NJ](#) [A01TK](#) [1206CS-471XJ](#) [HC2LP-R47-R](#) [HC2-R47-R](#) [HC3-2R2-R](#) [HCF1305-3R3-R](#) [1206CS-151XG](#) [RCH664NP-140L](#) [RCH664NP-4R7M](#) [RCH8011NP-221L](#) [RCP1317NP-332L](#) [RCP1317NP-391L](#)