

PRODUCT SPECIFICATION

SPEC. NO: T-0622-001p

DATE: Aug. 21, 2018

CUSTOMER'S PRODUCT NAME:

EMTEK PRODUCT NAME:

LCF1008-SERIES

THIS SPECIFICATION IS:

- FULLY ACCEPTED
- DENIED
- ACCEPTED UNDER THE FOLLOWING CONDITIONS



SIGNATURE: _____

DATE: _____

NAME(PRINT): _____

TITLE: _____

 **EMTEK CO., LTD.**

本文件內容全部或部份,未經兆欣科技股份有限公司同意不得以任何形式複製或其他用途
All rights reserved. This document or parts thereof, may not be reproduced by any means or used in any manner without written permission of EMTEK CO.,LTD.

FACTORY:

39, Chingao Rd., (305)Hsinpu,
Hsinchu Hsien, Taiwan, R. O. C
TEL: 03-5894-433
FAX: 03-5894-523

PRODUCT SPECIFICATION

SPEC. NO.

T-0622-001p



1. Scope

This specification applies Ferrite Chip Inductance LCF1008-Series to be delivered to user.

2. Product Identification

LCF 1008 - 100 \square - T

(1) (2) (3) (4) (5)

(1) Product name

(2) Shapes and dimensions

(3) Inductance

100 : 10 uH

(4) Tolerance

J=±5% , K=±10%

(5) Taping Type

3. Shapes and Dimensions

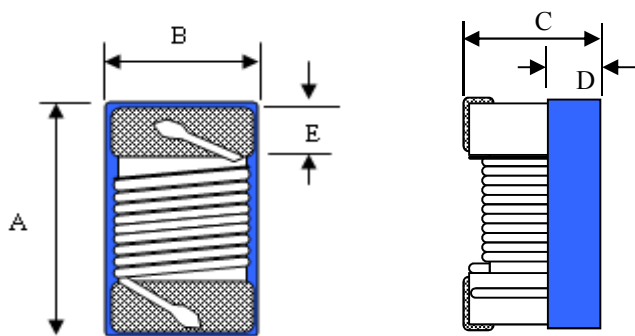

A max. : 2.90 mm

B max. : 2.54 mm

C max. : 2.0 mm

D ref. : 1.30 mm

E : 0.5 ± 0.1 mm

Equivalent circuit

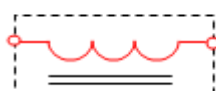

No Polarity

Drawn by	Checked by	Approved by
Cindy Aug. 2. 2017	Zheng Aug. 2. 2017	Shi Aug. 2. 2017



PRODUCT SPECIFICATION

SPEC. NO.

T-0622-001p

4. Electrical Characteristics

Customer Part Number	Our Product Part Number	Inductance (uH)/MHz	Inductance Tolerance	Q/MHz Typ.	SRF(Min.) (MHz)	Rdc (Ω)Max.	Isat Max. (mA)	Irms Typ. (mA)	Color Coding		
									1st	2nd	3rd
	LCF1008-78N□-T	0.078/7.9	J K	19/7.9	1000	0.042	3200	2700	Black	Violet	Gray
	LCF1008-R10□-T	0.10/25	J K	35/25	1500	0.05	3200	2700	Brown	Red	Brown
	LCF1008-R22□-T	0.22/25	J K	35/25	800	0.15	2900	2400	Red	Red	Brown
	LCF1008-R39□-T	0.39/25	J K	35/25	460	0.20	2100	1800	Orgnge	White	Brown
	LCF1008-R47□-T	0.47/25	J K	35/25	460	0.20	2100	1800	Yellow	Violet	Brown
	LCF1008-R56□-T	0.56/25	J K	35/25	360	0.26	1800	1500	Green	Blue	Brown
	LCF1008-R68□-T	0.68/25	J K	35/25	400	0.30	1700	1500	Blue	Gray	Brown
	LCF1008-R82□-T	0.82/25	J K	35/25	360	0.35	1400	1200	Gray	Red	Brown
	LCF1008-1R0□-T	1.0/7.9	J K	32/7.9	340	0.34	1700	1200	Brown	Black	Red
	LCF1008-1R1□-T	1.1/7.9	J K	25/7.9	300	0.34	1500	1100	Brown	Brown	Red
	LCF1008-1R2□-T	1.2/7.9	J K	25/7.9	300	0.25	1600	1100	Brown	Red	Red
	LCF1008-1R5□-T	1.5/7.9	J K	32/7.9	230	0.42	1200	1000	Brown	Green	Red
	LCF1008-1R8□-T	1.8/7.9	J K	27/7.9	180	0.45	1100	800	Brown	Gray	Red
	LCF1008-2R2□-T	2.2/7.9	J K	27/7.9	140	0.50	1100	900	Red	Red	Red
	LCF1008-2R7□-T	2.7/7.9	J K	27/7.9	130	0.55	1000	900	Red	Violet	Red
	LCF1008-3R3□-T	3.3/7.9	J K	27/7.9	125	0.60	1000	900	Orgnge	Orgnge	Red
	LCF1008-3R9□-T	3.9/7.9	J K	27/7.9	100	0.80	990	800	Orgnge	White	Red
	LCF1008-4R7□-T	4.7/7.9	J K	30/7.9	90	0.90	880	720	Yellow	Violet	Red

PRODUCT SPECIFICATION

SPEC. NO.

T-0622-001p



4. Electrical Characteristics

Customer Part Number	Our Product Part Number	Inductance (uH)/MHz	Inductance Tolerance	Q/MHz Typ.	SRF(Min.) (MHz)	Rdc (Ω)Max.	Isat Max. (mA)	Irms Typ. (mA)	Color Coding		
									1st	2nd	3rd
	LCF1008-5R6□-T	5.6/7.9	J K	27/7.9	60	1.00	850	720	Green	Blue	Red
	LCF1008-6R8□-T	6.8/7.9	J K	27/7.9	60	1.05	840	670	Blue	Gray	Red
	LCF1008-8R2□-T	8.2/7.9	J K	25/7.9	55	1.20	810	640	Gray	Red	Red
	LCF1008-100□-T	10/2.5	J K	23/2.5	55	1.55	700	540	Brown	Black	Orange
	LCF1008-120□-T	12/2.5	J K	23/2.5	36	2.10	580	460	Brown	Red	Orange
	LCF1008-150□-T	15/2.5	J K	23/2.5	36	2.38	580	460	Brown	Green	Orange
	LCF1008-180□-T	18/2.5	J K	23/2.5	32	2.50	520	410	Brown	Gray	Orange
	LCF1008-220□-T	22/2.5	J K	23/2.5	29	2.92	500	400	Red	Red	Orange
	LCF1008-270□-T	27/2.5	J K	23/2.5	22	3.70	450	300	Red	Violet	Orange
	LCF1008-330□-T	33/2.5	J K	23/2.5	21	4.10	420	300	Orgnge	Orgnge	Orange
	LCF1008-390□-T	39/2.5	J K	18/2.5	15	5.50	340	270	Orgnge	White	Orange
	LCF1008-470□-T	47/2.5	J K	23/2.5	17	7.80	310	220	Yellow	Violet	Orange
	LCF1008-680□-T	68/2.5	J K	20/2.5	9	11.50	220	180	Blue	Gray	Orange
	LCF1008-101□-T	100/1	J K	13/1	4	13.20	210	170	Brown	Black	Yellow
	LCF1008-151□-T	150/1	J K	13/1	3	22.50	170	160	Brown	Green	Yellow
	LCF1008-221□-T	220/1	J K	13/1	3	26.50	160	100	Red	Red	Yellow
	LCF1008-271□-T	270/1	J K	13/1	2	32.00	135	95	Red	Violet	Yellow
	LCF1008-331□-T	330/1	J K	13/1	2	32.50	130	90	Orgnge	Orgnge	Yellow



PRODUCT SPECIFICATION

SPEC. NO.

T-0622-001p

1. When ordering, please specify tolerance and packaging codes. Ex: LCF1008-4R7K-T

Tolerance : J = $\pm 5\%$, K = $\pm 10\%$

Packaging : Clear tape and reel { standard }.

2. L、Q、SRF : Agilent E4991A RF Impedance/Material Analyzer +

Agilent 16197A Test Fixtures (The electrical specification test by the smallest gap position)

3. Rdc : Chroma Milliohmmeter 16502, or equivalent.

4. Isat for Inductance drop 35% from its value without current.

5. Operating temperature range from -25°C to 105°C .

6. Irms for a 40°C rise above 25°C ambient.

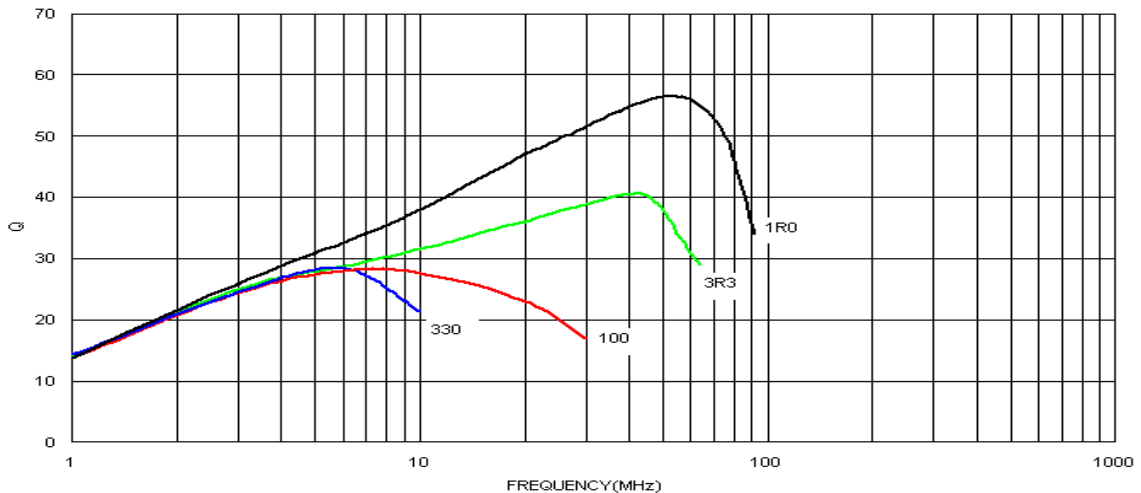
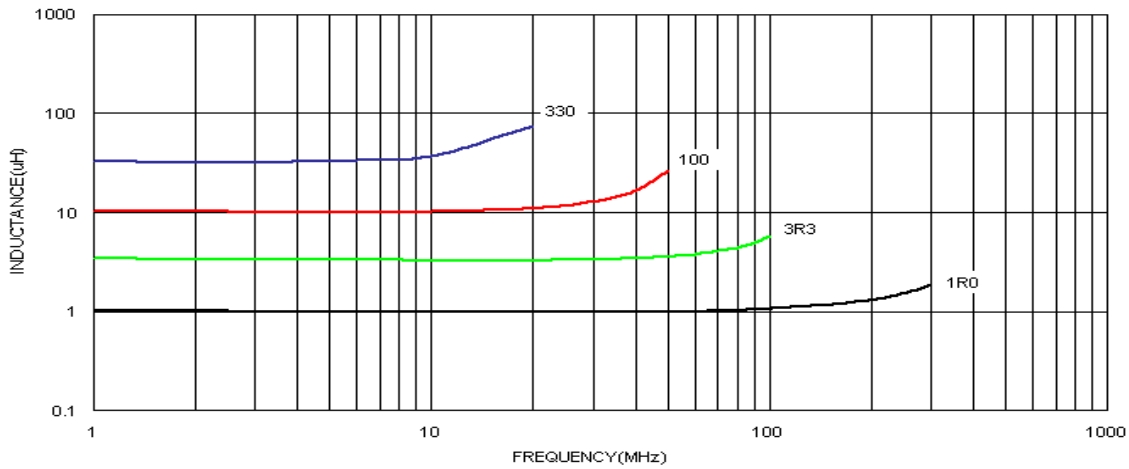
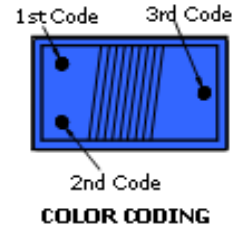

PRODUCT SPECIFICATION

SPEC. NO.

T-0622-001p



LCF1008-1R8J-T

Ls V.S Frequency

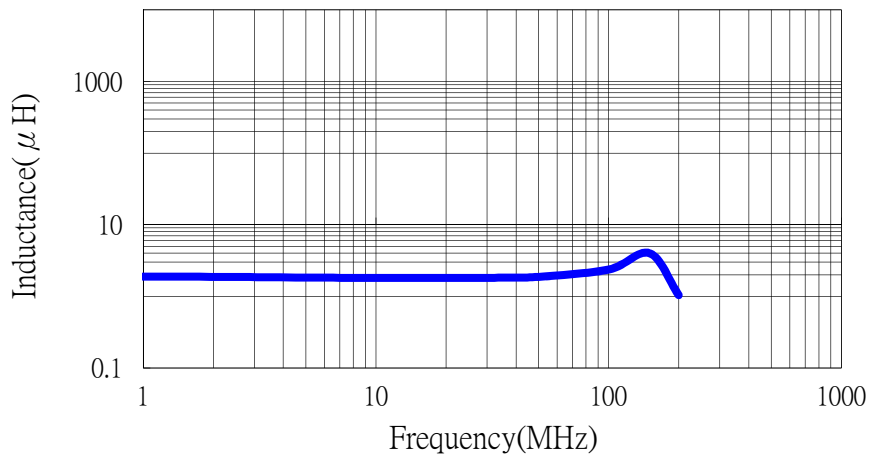

LCF1008-1R8J-T

Q V.S Frequency

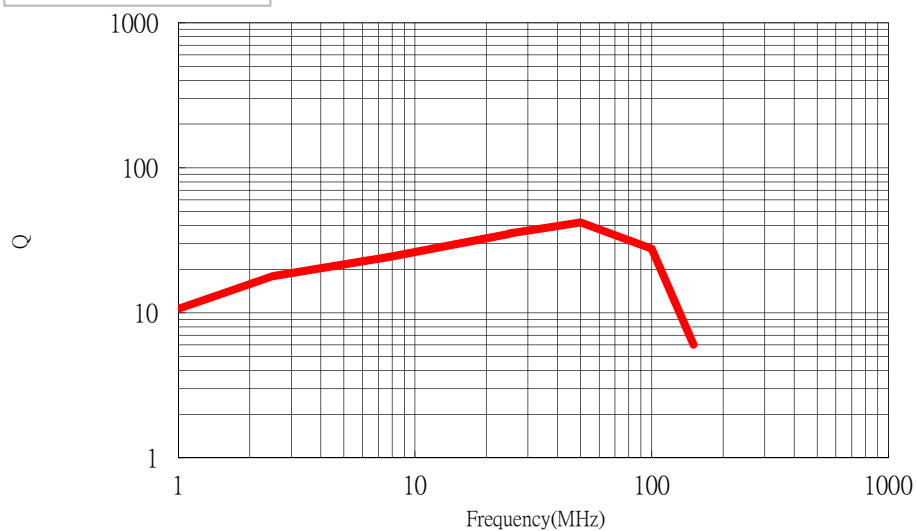

5. Material list

Item	Material
Core	Ferrite core
Wire	Copper wire
Epoxy	UV Epoxy

PRODUCT SPECIFICATION

SPEC. NO.

T-0622-001p



6. Reliability Test

Item	Specifications	Test conditions
Solderability	The metalized area must have 90% minimum solder coverage.	Dip pads in flux and dip in solder pot(96.5 Sn/3.5 Ag solder) at 255°C ±5°C.
Resistance to soldering heat	There must be no case deformation or change in dimensions. Inductance must not change more than the stated tolerance.	Inductors shall be reflowed onto a PC board using 96.5 Sn/3.5 Ag solder paste. Solder process shall be at a maximum temperature of 260°C. For 96.5 Sn/3.5 Ag solder paste:>217°C for 90 seconds
Vibration	There must be no case deformation or change in dimensions. Inductance must not change more than the stated tolerance.	Solder specimen inductor on the test printed circuit board. Apply vibrations in each of the x,y and z directions for 2 hours for a total of 6 hours. Frequency : 10~50 Hz Amplitude : 1.5mm
High temperature resistance	There must be no case deformation or change in dimensions. Inductance must not change more than the stated tolerance.	Inductors shall be subjected to temperature 105±2°C for 500±12 hours. Measure the test items after leaving the inductors at room temperature and humidity for 2 hours.
Static Humidity	Inductors must not have a shorted or openwinding.	Inductors shall be subjected to temperature 85±2°C and 90 to 95%RH. for ten 24-hours. Measure the test items after leaving the inductors at room temperature and humidity for 2 hours.
Component adhesion (push test)	Inductors shall be subjected to 1.8Kg	Inductors shall be reflow soldered (255°C ±5°C for 10 seconds) to a tinned copper substrate. A force gauge shall be applied to the side of the component. The device must withstand the stated force without a failure of the termination.

PRODUCT SPECIFICATION

SPEC. NO.

T-0622-001p



Item	Specifications	Test conditions
Low temperature resistance	There must be no case deformation or change in dimensions. Inductance must not change more than the stated tolerance.	Inductors shall be subjected to temperature $-25\pm 2^{\circ}\text{C}$ for 500 ± 12 hours. Measure the test items after leaving the inductors at room temperature and humidity for 1 to 2 hours.
Resistance to solvent	There must be no case deformation, change in dimensions, or obliteration of marking.	Inductors must withstand 6 minutes of alcohol or water.
Thermal Shock	There must be no case deformation or change in dimensions. Inductance must not change more than the stated tolerance.	Inductors shall be subjected to 10 cycles to the following temperature cycle: <div style="text-align: center; margin: 10px 0;"> </div> Measure the test items after leaving the inductors at room temperature and humidity for 2 hours.

PRODUCT SPECIFICATION

SPEC. NO.

T-0622-001p



7. Packaging

The packaging must be done not to receive any damage during transporting and storing.

7-1 Tape dimensions

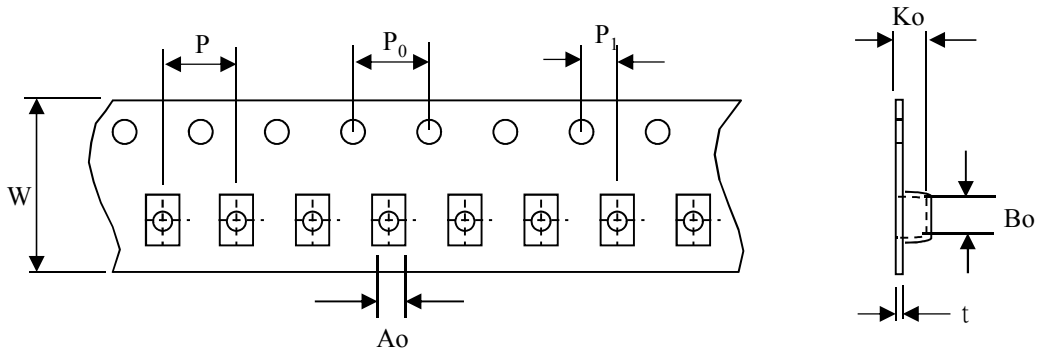

(Dimensions in mm; Tolerance : ± 0.1)

Symbol	W	P	P ₀	P ₁	A _o	B _o	K _o	t
Dimension	8	4	4	2	2.5	2.85	2	0.22

7-2 Reel dimensions

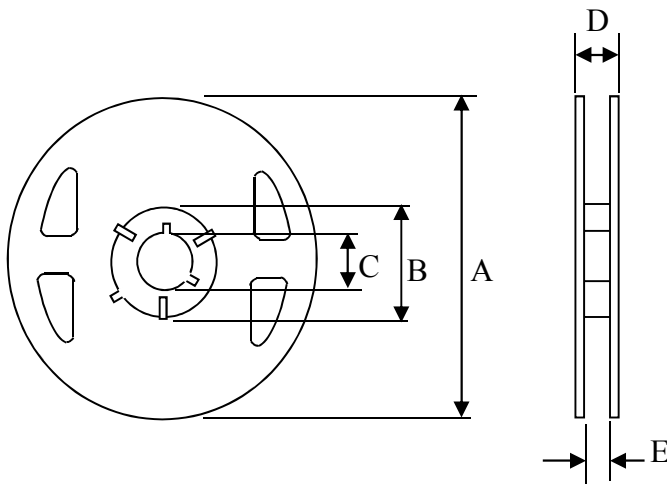

Symbol	T
A	180
B	60
C	13
D	14.4
E	8.4

7-3 Tapping figure

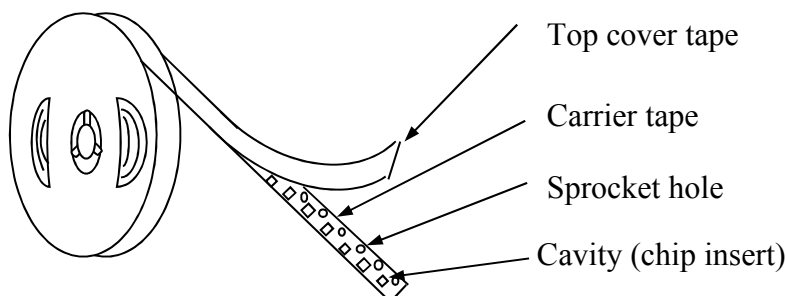

PRODUCT SPECIFICATION

SPEC. NO.

T-0622-001p



7-4 Packaging Form

There shall not continuation more than two vacancies of the product.

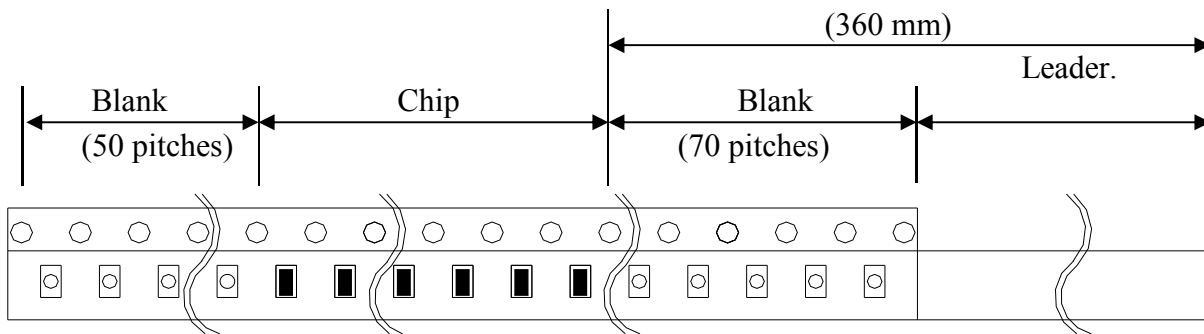

7-5 Cover Tape Peel Strength

The force for tearing off cover tape is 0.1~0.6(N) in the arrow direction at the following conditions:

Temperature : 5 ~ 35°C

Humidity : 45 ~ 85%

Atmospheric pressure : 860 ~ 1060 hpa

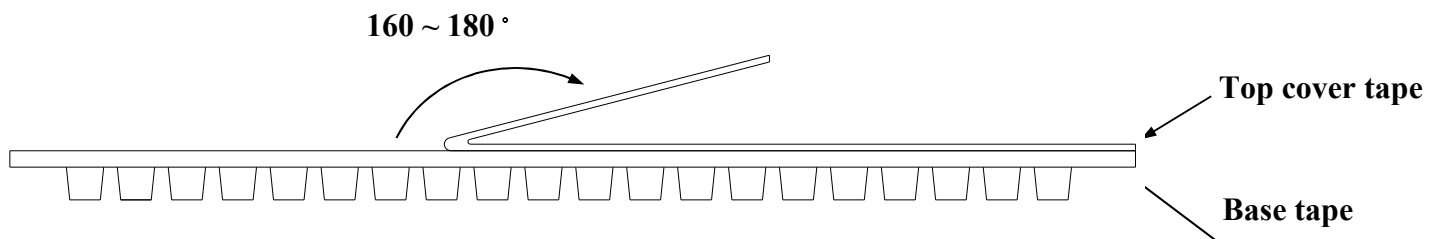

7-6 Packing Quantity

φ180 mm reel type : 2,000 pcs./reel

PRODUCT SPECIFICATION

SPEC. NO.

T-0622-001p



8. Recommended Soldering Conditions

(Please use this product by reflow soldering)

8-1 Recommended Footprint

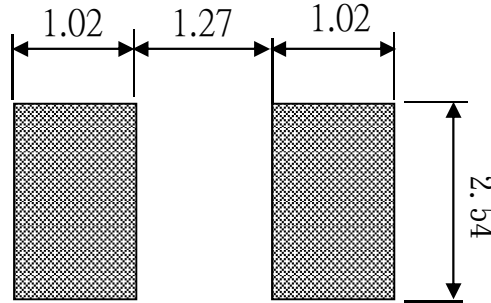

Unit: mm

8-2 Recommended Reflow Pattern

Reflow at 260°C/3 Cycles

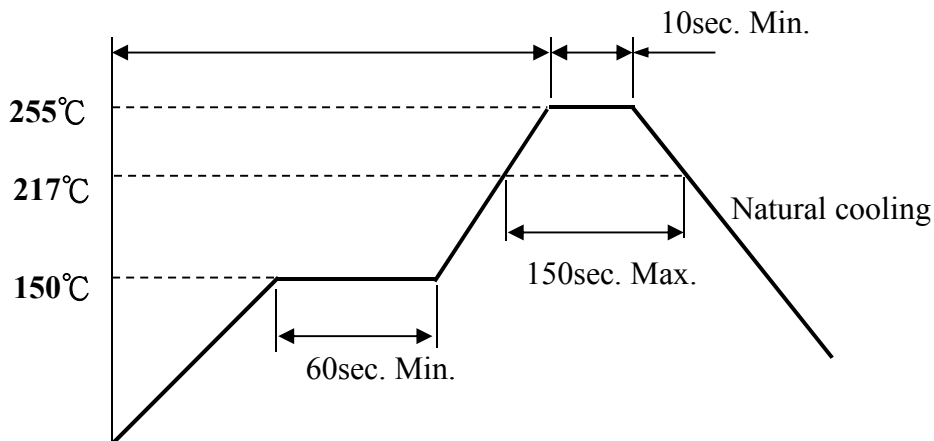

8-3 Iron Soldering

Use a solder iron of less than 30W when soldering, do not allow the soldering iron to directly touch the Ceramic body outside of terminal electrode.

5 seconds max. at 260°C.

9. Attention in Case of Using

In case of using product, please avoid following matters:

Splashing water or salt water

Dew condenses

Toxic gas (Hydrogen sulfide, Sulfurous acid, Chlorine, Ammonia)

Vibrations or shocks which exceed the specified condition

Please be careful for the stress to this product by board flexure or something after the mounting.

10. Others

10-1 Operating temperature range : Ferrite Series : -25~+105°C

10-2 Storage condition : Temperature 20°~25°C, Relative Humidity 40%~60%

10-3 Recommended wire wound inductors should be used within 6 months from the time of delivery.

X-ON Electronics

Largest Supplier of Electrical and Electronic Components

Click to view similar products for [Fixed Inductors](#) category:

Click to view products by [EMTEK](#) manufacturer:

Other Similar products are found below :

[CR32NP-100KC](#) [CR32NP-151KC](#) [CR32NP-180KC](#) [CR32NP-181KC](#) [CR32NP-1R5MC](#) [CR32NP-390KC](#) [CR32NP-3R9MC](#) [CR32NP-680KC](#) [CR32NP-820KC](#) [CR32NP-8R2MC](#) [CR43NP-390KC](#) [CR43NP-560KC](#) [CR43NP-680KC](#) [CR54NP-181KC](#) [CR54NP-470LC](#) [CR54NP-820KC](#) [CR54NP-8R5MC](#) [70F224AI](#) [MGDQ4-00004-P](#) [MHL1ECTTP18NJ](#) [MHQ1005P10NJ](#) [MHQ1005P1N0S](#) [MHQ1005P2N4S](#) [MHQ1005P3N6S](#) [MHQ1005P5N1S](#) [MHQ1005P8N2J](#) [PE-51506NL](#) [PE-53601NL](#) [PE-53602NL](#) [PE-53630NL](#) [PE-53824SNLT](#) [PE-92100NL](#) [PG0434.801NLT](#) [PG0936.113NLT](#) [9220-20](#) [9310-16](#) [PM06-2N7](#) [PM06-39NJ](#) [A01TK](#) [1206CS-471XJ](#) [HC2LP-R47-R](#) [HC2-R47-R](#) [HC3-2R2-R](#) [HCF1305-3R3-R](#) [1206CS-151XG](#) [RCH664NP-140L](#) [RCH664NP-4R7M](#) [RCH8011NP-221L](#) [RCP1317NP-332L](#) [RCP1317NP-391L](#)