

ENERGIZER E91

AA

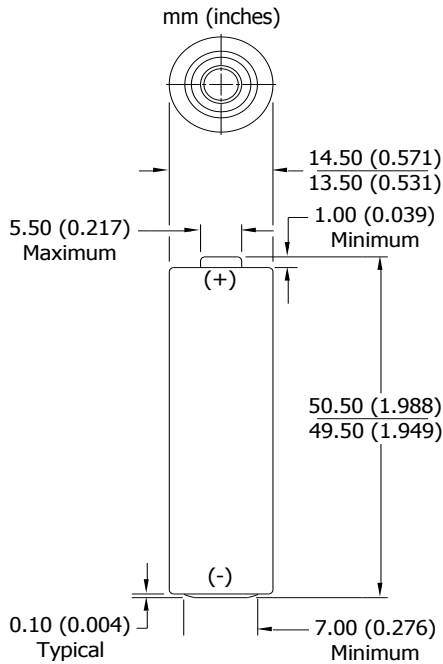

Industry Standard Dimensions



Specifications

Classification:	Alkaline
Chemical System:	Zinc-Manganese Dioxide (Zn/MnO ₂) No added mercury or cadmium
Designation:	ANSI-15A, IEC-LR6
Nominal Voltage:	1.5 volts
Nominal IR:	150 to 300 milliohms (fresh)
Operating Temp:	-18°C to 55°C (0°F to 130°F)
Typical Weight:	23.0 grams (0.8 oz.)
Typical Volume:	8.1 cubic centimeters (0.5 cubic inch)
Jacket:	Plastic Label
Shelf Life:	10 years at 21°C
Terminal:	Flat Contact

Milliamp-Hours Capacity

Continuous discharge to 0.8 volts at 21°C

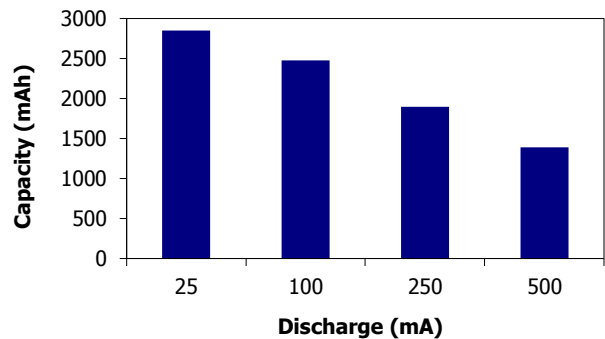

Device Selection Guide:

- Digital Camera 
- Photoflash 
- Games, CD's, MD's 
- Tape Player 
- Lighting 
- Toy 
- Remote Control 
- Radio 
- Clock 

Battery Selection Indicator

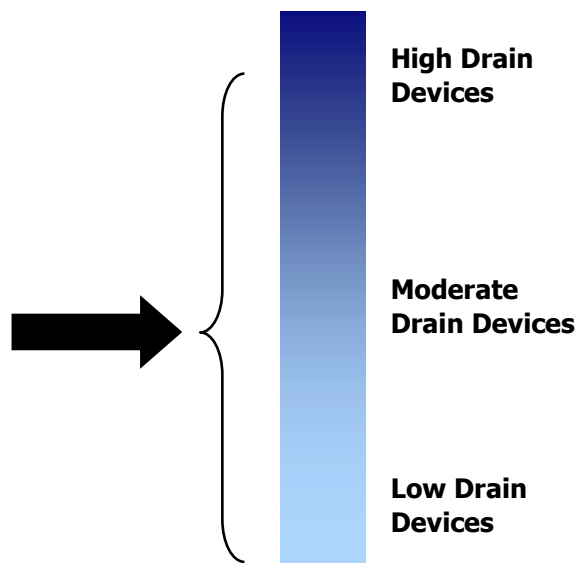

Important Notice

This data sheet contains typical information specific to products manufactured at the time of its publication.
©Energizer Holdings, Inc. - Contents herein do not constitute a warranty.

ENERGIZER E91

AA

Constant Power Performance

Typical Characteristics (21°C)

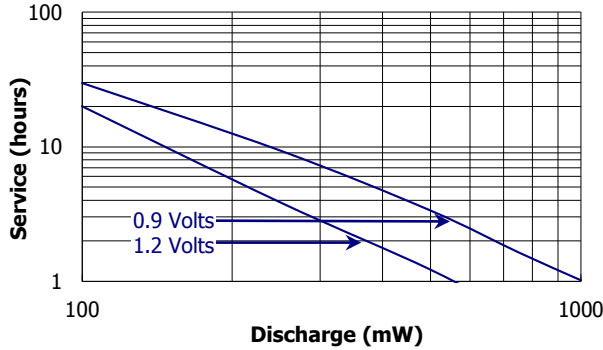

Constant Current Performance

Typical Characteristics (21°C)

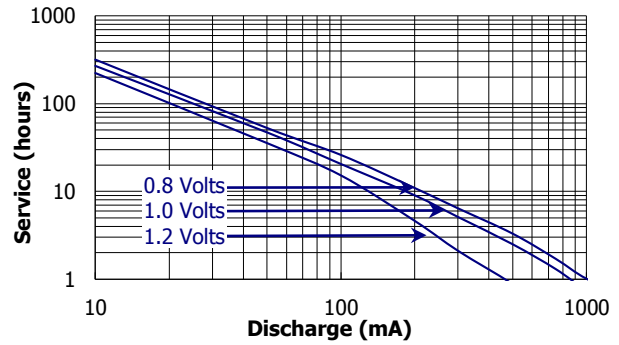

Constant Power Performance

Discharge Characteristics (21°C)

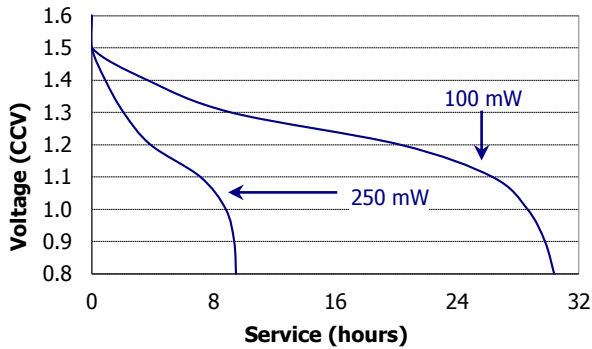

Constant Current Performance

250 mA Discharge (-20°C / 0°C / 21°C)

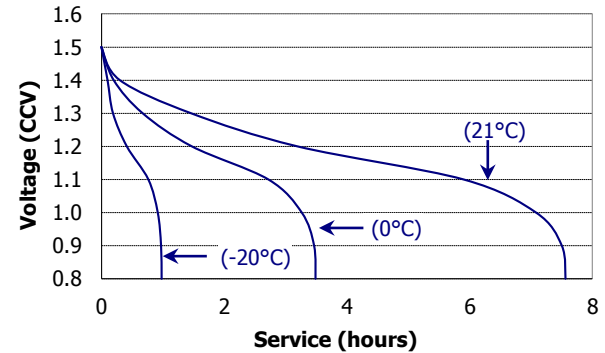

Industry Standard Tests (21°C)

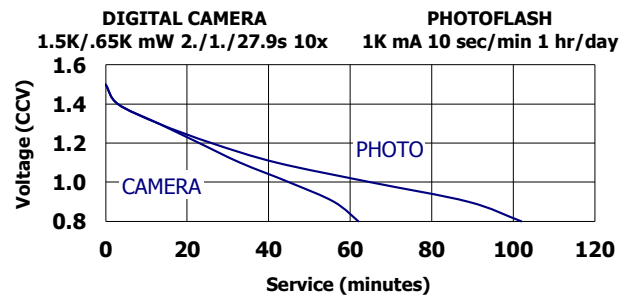
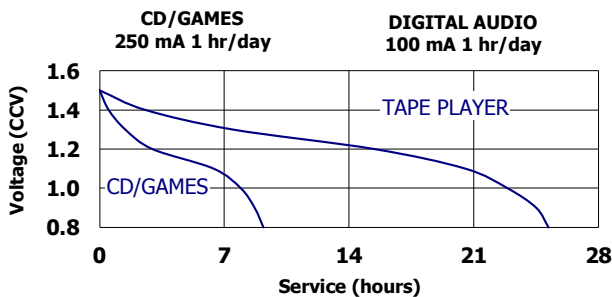
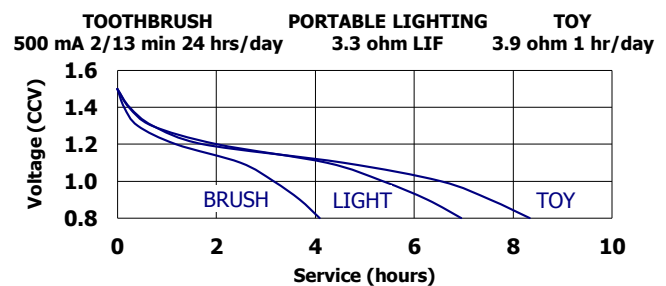
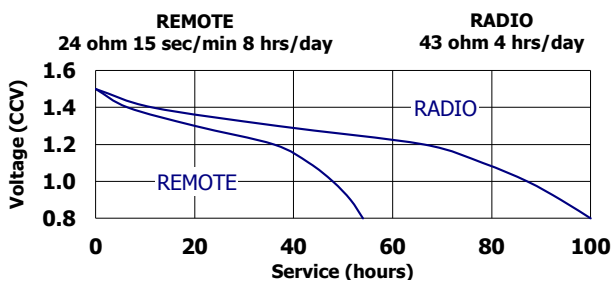

Important Notice

This data sheet contains typical information specific to products manufactured at the time of its publication.

©Energizer Holdings, Inc. - Contents herein do not constitute a warranty.

X-ON Electronics

Largest Supplier of Electrical and Electronic Components

Click to view similar products for [Battery Packs](#) category:

Click to view products by [Energizer](#) manufacturer:

Other Similar products are found below :

[2280309-1](#) [R101-B](#) [4114 210 501](#) [4120 210 501](#) [4600 726 406](#) [4610 726 406](#) [312G-U1](#) [55615703012](#) [3LR12](#) [4103 210 392](#) [4103 210 394](#)
[4106 210 392](#) [4106 210 394](#) [4223 210 501](#) [4606 726 406](#) [4607 726 406](#) [ZA13](#) [LR03/AAA/MN2400\(K4\)](#) [LR03 MAXELL S4](#) [LR1130](#)
[MAXELL B10](#) [LR14-MN1400-C K2](#) [LR1/910A](#) [LR41 MAXELL B10](#) [LR43](#) [LR43 MAXELL B10](#) [LR6 MAXELL S4](#) [11012](#) [E23A](#) [E90](#)
[625302](#) [625304](#) [637871](#) [638006](#) [6LF22/9V/MN1604\(K1\)C&B](#) [6LF22/9V/MN1604 PLUS](#) [6LR61](#) [SR626SW MAXELL](#) [SR920SW](#)
[MAXELL](#) [7K67 J](#) [55615303059](#) [GP14A S2](#) [GP15E](#) [GP1604GLF-2UE1](#) [GP 1604 ULTRA PLUS](#) [23733](#) [10 ET](#) [675 ET](#) [11A B5](#) [A544](#) [A76-](#)
[U10](#)