

ENERGIZER EN22

9V

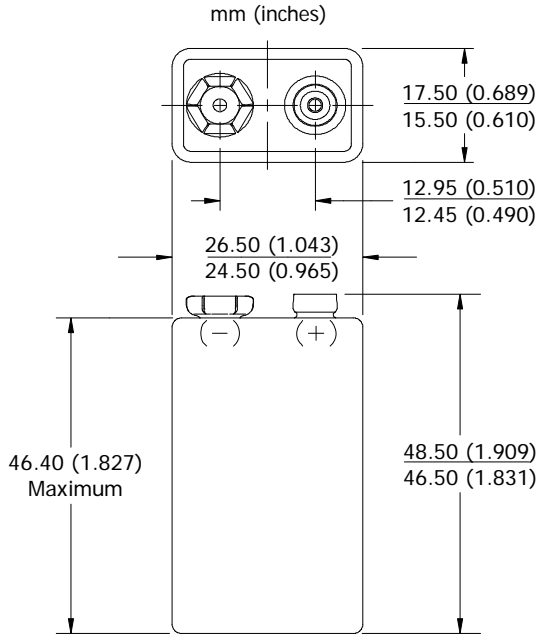

Industry Standard Dimensions



Specifications

NOT INTENDED FOR RETAIL TRADE

Classification:	Alkaline
Chemical System:	Zinc-Manganese Dioxide (Zn/MnO ₂) No added mercury or cadmium
Designation:	ANSI-1604A, IEC-6LR61
Nominal Voltage:	9.0 volts
Operating Temp:	-18°C to 55°C (0°F to 130°F)
Typical Weight:	45.6 grams (1.6 oz.)
Typical Volume:	21.1 cubic centimeters (1.3 cubic inch)
Jacket:	Metal
Shelf Life:	5 years at 21°C (80% of initial capacity)
Terminal:	Miniature Snap

Milliamp-Hours Capacity

Continuous discharge to 4.8 volts at 21°C

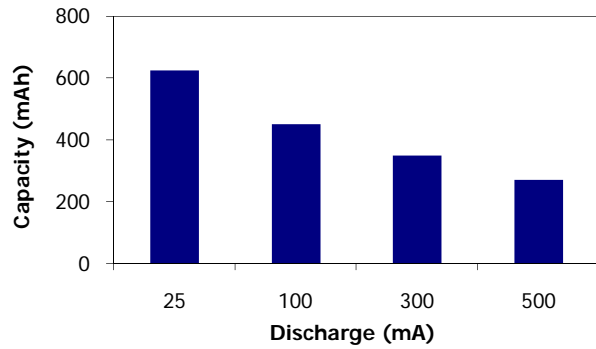

Constant Resistance Performance

Typical Characteristics (21°C)

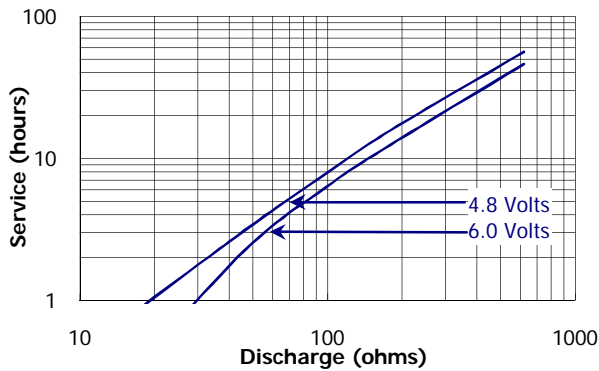

Constant Current Performance

Typical Characteristics (21°C)

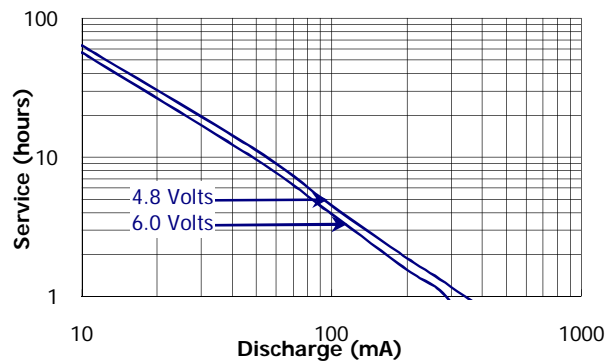

Important Notice

This datasheet contains typical information specific to products manufactured at the time of its publication.
©Energizer Holdings, Inc. - Contents herein do not constitute a warranty.

ENERGIZER EN22

9V

Industry Standard Tests (21°C)

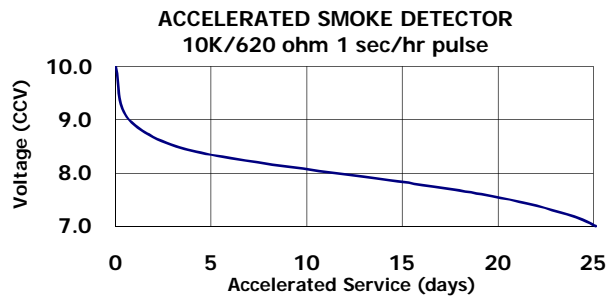
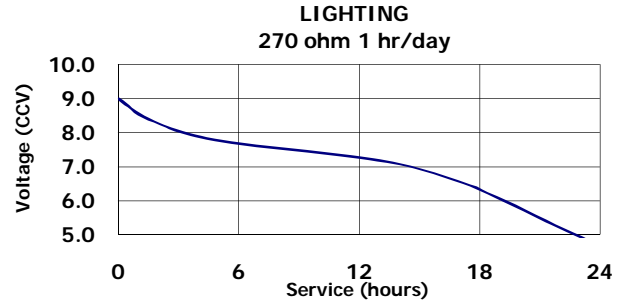
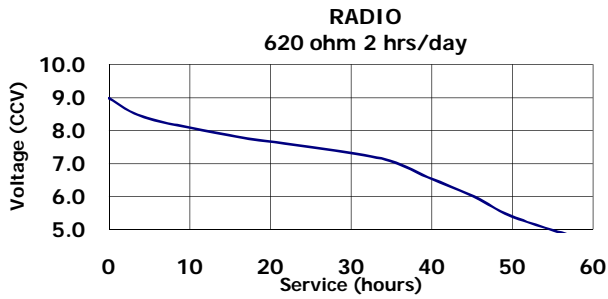

Important Notice

This datasheet contains typical information specific to products manufactured at the time of its publication.
©Energizer Holdings, Inc. - Contents herein do not constitute a warranty.

X-ON Electronics

Largest Supplier of Electrical and Electronic Components

Click to view similar products for [Control Switches](#) category:

Click to view products by [Energizer](#) manufacturer:

Other Similar products are found below :

[80887-99](#) [80932-99](#) [86855-00](#) [88814-30](#) [1424293-1](#) [HW4S-2TC10](#) [89721-12](#) [89804-08](#) [SSN](#) [RL01801](#) [ASD2L20N-LVO](#) [50051857-17](#)
[50099156-001-05](#) [51.155R-15200](#) [50058920-26](#) [CP-FA51](#) [CP-FA49](#) [ACCU-SC/L-3000](#) [PP9M](#) [PP87G](#) [PP86GA](#) [PP71G](#) [PP70G](#) [PP6G](#)
[PP62G](#) [PP58BL](#) [PP56G](#) [PP86GB](#) [PP77GA](#) [PP76G](#) [PP4M](#) [PP47G](#) [PP46G](#) [PP41M](#) [PP40G](#) [PP32G](#) [RD-20](#) [PP23M](#) [PP12G](#) [PORTAPRO](#)
[POM-2708](#) [PNB-2005](#) [3057.0012](#) [CV-075](#) [CV-140SB](#) [CV-150](#) [CV-150S](#) [214X20XK](#) [CV-180](#) [CV-200MB](#)