

SCREW REMOVAL

Screw Removal Pliers, Rapid Screw Extractor, etc.

2

SCREW
REMOVAL

SCISSORS

Combination Scissors, Cable Shears, etc.

10

SCISSORS

NIPPERS

Micro Nippers, Parallel Nippers, Diagonal Nippers, Plastic Nippers, etc.

15

NIPPERS

PLIERS

Miniature Pliers, Long Nose Pliers, Combination Pliers, E-Ring Pliers, etc.

20

PLIERS

CRIMPING AND STRIPPING

Handy Crimp Tool, Universal Crimping Pliers, Pin Extractor, Wire Strippers, etc.

24

CRIMPING
STRIPPING

TWEEZERS

Tweezers, Titanium Tweezers, ESD Plastic-Tipped Tweezers, etc.

32

TWEEZERS

SCREWDRIVERS

Master Grip Drivers, Pro-Use Drivers, Stubby Drivers, Offset Ratchet Drivers, etc.

37

SCREW
DRIVERS

SPECIAL DRIVERS

Mobile Phone Drivers, Nut Drivers, Hex Drivers, Ceramic Alignment Screwdrivers, etc.

42

SPECIAL
DRIVERS

WRENCHES

Smart Monkey Wrench, Ball Point Hex Wrench Set, Socket Wrench Set, etc.

50

WRENCHES

CUTTING AND PROCESSING

Taper Reamer, Vise, Jeweller's Saw, Jet Black Files, etc.

55

CUTTING
PROCESSING

SETS AND CASES

Maintenance Kits, Tool Kits, Electronics Kits, Aluminium Cases, Parts Boxes, etc.

59

SETS
CASES

SOLDERING EQUIPMENT

Soldering Irons, Kotelyzers, Desoldering Tool, Solder Sucker, Digital Multimeter, Loupes, etc.

69

SOLDERING
EQUIPMENT

ESD PRODUCTS AND CHEMICALS

Anti-Static Service Kit, Dust-Free Gloves, Conductive Colored Mat, Rust Remover, etc.

80

ESD
CHEMICALS



Screw Removal

SCREW REMOVAL PLIERS SERIES

PATENTED TECHNIQUE

Remove all kinds of screws, fasteners, pins, etc. easily!

PZ-22

RoHS SCREW EATER

Finally, the world-standard model of the Screw Removal Pliers!

- Vertical serrations bite and grip a screw head without slippage.
- Also good for Truss head screw. *Truss: Lower-profile dome head
- Also ideal for situations when the correct size or type of screwdriver is not available.
- Serrated side teeth lined consecutively, inter-meshed with each other. Good for holding a thin plate securely.
- Owing to T-shaped forging handles, the handle sleeve will not twist or slip off during heavy duty use.

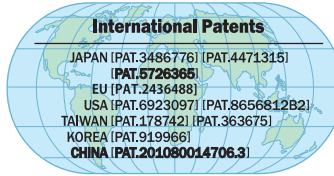

Vertical serrations

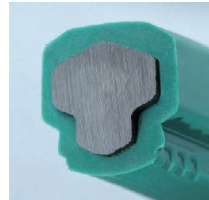

T-shaped handle

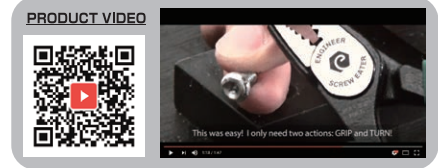

Vertical Serrations (PAT.)

You can remove damaged screws in seconds. Just grip and turn!



Inter-meshed Teeth (PAT.)

Need to hold a thin material? Get a firm grip!



How does it work?

Ordinary pliers

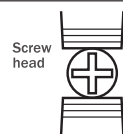

Ordinary plier jaws are lined with horizontal serrations. When you grasp and turn a screw head with ordinary pliers, the jaws slip and the screw remains stuck.

"Vertical serrations"

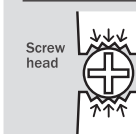

Specially-designed jaws generate gripping power.

"Maximizes the friction"



Perfect fitting serrations maximize friction with no slippage.

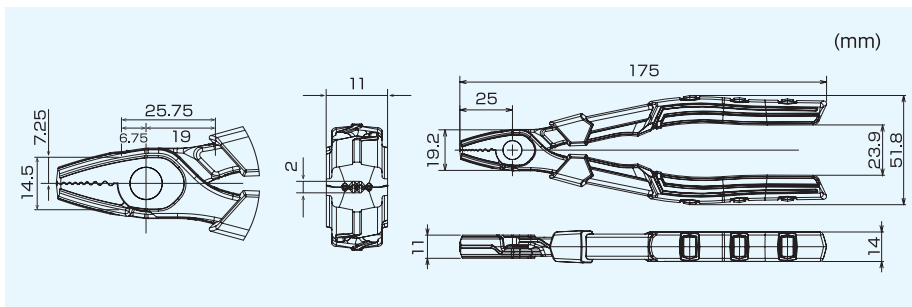

Screw head size

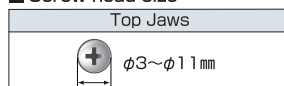

Item No.	Material	Hardness	Wgt.(g)
PZ-22	Carbon Steel	HRC60±2	165

Rust Remover (ZC-28)

Screw stuck due to rust? Try our Rust Remover to remove the rust off screws within seconds!

Turn to page 84 for further information.

Works in seconds
 Penetrates along threads
 Low harmful to skin

SCREW REMOVAL

SCISSORS

NIPPERS

PLIERS

CRIMPING STRIPPING

TWEEZERS

SCREW DRIVERS

SPECIAL DRIVERS

WRENCHES

CUTTING PROCESSING

SETS CASES

SOLDERING EQUIPMENT

ESD CHEMICALS



Remove all kinds of screws, fasteners, pins, etc. easily!

PZ-58

RoHS SCREW REMOVAL PLIERS GT

The best selling Screw Removal Pliers in the whole world!!

- Elaborately-designed serration fits the profile of screw head at the best angle.
- Also good for Truss head screw. *Truss: Lower-profile dome head
- with wire cutter (Capacity: copper wire $\phi 1.2\text{mm}$)
- Owing to T-shaped forging handles, the handle sleeve will not twist or slip off during heavy duty use.



PZM-58 RoHS PLIERS MASK FOR PZ-58

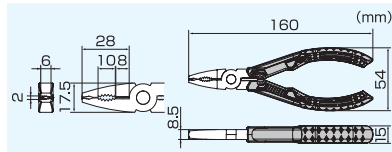
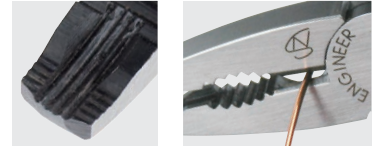

Item No.	Material	Hardness	Wgt. (g)
PZ-58	Carbon Steel	HRC58 ± 2	130

■ Screw head size

Top Jaws
$\phi 3 \sim \phi 9.5\text{mm}$

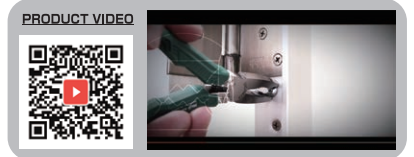

PZ-59

RoHS SCREW REMOVAL PLIERS RX

- Removes screws with stripped or rusted heads or stubborn fasteners in seconds
- Also good for Truss head screw. *Truss: Lower-profile dome head
- Inter-meshed side teeth even hold a very thin plate securely, no slippage!
- Owing to T-shaped forging handles, the handle sleeve will not twist or slip off during heavy duty use.

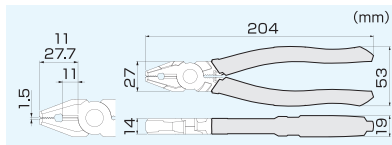
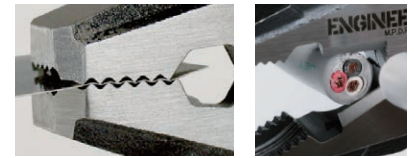

Item No.	Material	Hardness	Wgt. (g)
PZ-59	Carbon Steel	HRC60 ± 2	300

■ Screw head size

Top Jaws
$\phi 3 \sim \phi 15\text{mm}$



PZ-60

RoHS SCREW REMOVAL PLIERS Z

- Long nose ideal for a hard-to-reach small screws up to 5.5mm
- Vertical serrations bite a screw head without slippage.
- Also good for Truss head screw. *Truss: Lower-profile dome head
- Inter-meshed teeth to hold even a thin plate securely, so no slippage.
- Owing to T-shaped forging handles, the handle sleeve does not twist or slip off the handle.

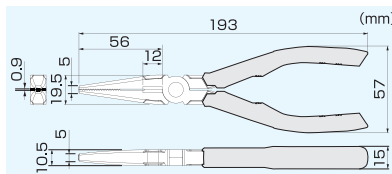
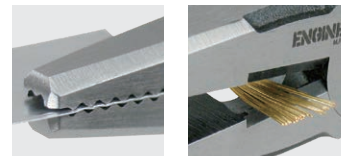

Item No.	Material	Hardness	Wgt. (g)
PZ-60	Carbon Steel	HRC60 ± 2	180

■ Screw head size

Top Jaws
$\phi 2 \sim \phi 5.5\text{mm}$ (Head Height < 2.2mm)



PZ-55

SCREW REMOVAL PLIERS

The basic Screw Removal Pliers: Powerful and simple!

- Serrated jaw inside bites screw head firm and unfastens it with no slip.
- More powerful torque than screwdriver toward screw & nut
- Also ideal for rotating nut in case of no space to drive wrench in arc
- ※ For screw whose head was damaged and transformed
- ※ For screw whose slot on the head is special, unique or tamper-proof
- ※ For screw frozen with rust

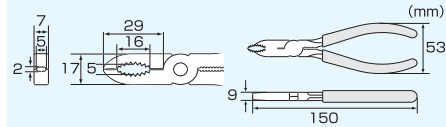

■ Screw head size

Top Jaws
$\phi 3 \sim \phi 8 \text{mm}$

Item No.	Material	Hardness	Wgt.(g)
PZ-55	S58C	HRC56±2	125

PZ-56

SCREW REMOVAL PLIERS XP

Feel the powerful and extensive work !!

- Slip joint function makes it possible to select two points of opening jaws.
- Reverse cross-jointed structure to reduce the load which is imposed at joint bolt while unfastening work.

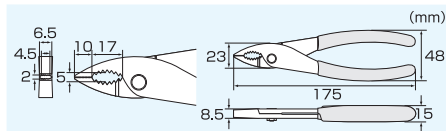
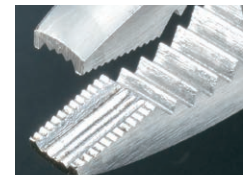
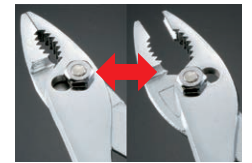

■ Screw head size

Top Jaws
$\phi 3 \sim \phi 10 \text{mm}$

Item No.	Material	Hardness	Wgt.(g)
PZ-56	Cr-V	HRC56±2	187

PZ-57

SCREW REMOVAL PLIERS M2

Slender jaws and pocket-sized body

- Ideal for unfastening frozen or special screws of tiny size
- ESD-Safe handle made of thermoplastic Elastomer (TPR) featuring comfortable grip



with strap hole



ESD-Safe handle (1x10⁶~10⁷Ω/sq)

Top Jaws Side Jaws

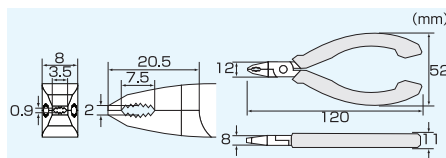

■ Screw head size

Top Jaws
$\phi 2 \sim \phi 3.5 \text{mm}$

Item No.	Material	Hardness	Wgt.(g)
PZ-57	S58C	HRC56±2	100

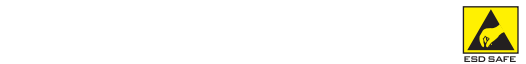

PCB



Hard Disk Drive



Damaged screw



Torx screw

SCREW REMOVAL

SCISSORS

NIPPERS

PLIERS

CRIMPING STRIPPING

TWEEZERS

SCREW DRIVERS

SPECIAL DRIVERS

WRENCHES

CUTTING PROCESSING

SETS CASES

SOLDERING EQUIPMENT

ESD CHEMICALS

PZ-32

1RoHS SCREW REMOVAL PLIERS JS

- Vertical serrations bite and grip a screw head without slippage.
- Also good for Truss head screw. *Truss: Lower-profile dome head
- Serrated side teeth lined consecutively, inter-meshed with each other
- Black oxide finish to increase rust-resistance!
- Owing to T-shaped forging handles, the handle sleeve will not twist or slip off during heavy duty use.



PZM-30 1RoHS PLIERS MASK FOR PZ-32

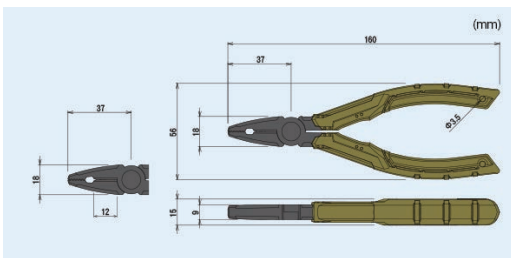

Inter-meshed, never let go.

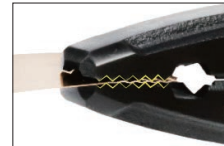

Strap hole goes through the steel handle.



■ Screw head size

Top Jaws
⊕ $\phi 3 \sim \phi 9.5\text{mm}$

Item No.	Size	Material	Hardness	Cutting Capacity	Wgt.	Safety Hole
PZ-32	160mm	Body:Carbon Steel Handles:TPR	HRC60±2	$\phi 1.2\text{mm}$ (copper wire)	125g	$\phi 3.5\text{mm}$

PZ-64·65

1RoHS SCREW REMOVAL LOCKING PLIERS

- Vertically serrated jaws bite a screw head while locking it securely. It helps to optimize your hand strength for twisting off stubborn screws.
- Also good for Truss head screw. *Truss: Lower-profile dome head
- Quick release mechanism, just open the handles to unlock the gripping jaws
- Rubber handles provide you with a comfortable grip.

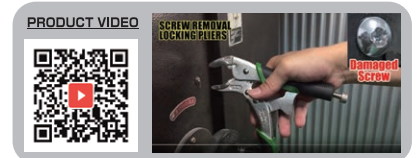
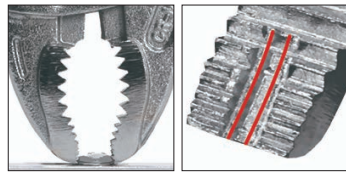

PZ-65



PZ-64

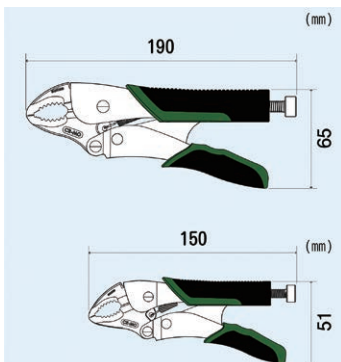

■ Screw head size

Item No.	Top Jaws
PZ-64	⊕ $\phi 3 \sim \phi 9.5\text{mm}$
PZ-65	⊕ $\phi 7 \sim \phi 12\text{mm}$

Item No.	Max.Jaws	Cutting Capacity	O.A. Length	Hardness (Jaws)	Wgt.	Material
PZ-64	38mm	Steel wire $\phi 1.6\text{mm}$	150mm	HRC57±3	205g	Body:Cr-Mo
PZ-65	48mm	Steel wire $\phi 2.3\text{mm}$	190mm		400g	Handles:TPR

KS-34**SCREW EMERGENCY TOOL KIT**

The all-in-one solution for your screw troubles!

- Screw Eater + Rapid Screw Extractor with 3 bits
 - Lightweight and stylish bundle case
- *Turn to page 08 for more information on the Rapid Screw Extractor

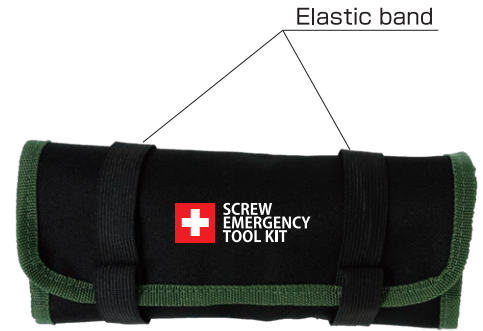

Compact and lightweight!

■ Contents

Item No.	Description
PZ-22	Screw Eater
DBZ-50G	Handle Grip for DBZ (Green)
DBZ-51	⊕#2 (Press & Twist type bit)
DBZ-52	⊕#2 (Strike & Turn type bit)
DBZ-57	⊕#1 (Press & Twist type bit)
	Bundle case

Item No.	Case Size (When unfold)	Wgt.
KS-34	380×220mm	394g

PDS-01**SCREW REMOVAL TOOL KIT**

Screw Removal Pliers GT with Mask
+ Rapid Screw Extractor with 5 bits
in a compact heavy duty case

*Turn to page 08 for more information on the Rapid Screw Extractor



■ Contents

Item No.	Description
PZ-58	Screw Removal Pliers GT
PZM-58	Pliers Mask for PZ-58
DBZ-50B	Handle Grip For DBZ (Black)
DBZ-51	⊕#2 (Press & Twist type bit)
DBZ-52	⊕#2 (Strike & Turn type bit)
DBZ-53	Hex socket screw(●:2.5-3.0mm)
DBZ-54	Hex socket screw(●:4.0mm)
DBZ-56	Hex socket screw(●:5.0mm)
	Bit holder

PGT-03 GT PACK(PAULOWNIA BOX)

The perfect gift for tool lovers!

- The Screw Removal Pliers GT and the Combination Scissors GT in a beautiful box made of paulownia wood.



■ Contents

Item No.	Description
PZ-58	Screw Removal Pliers GT
PZM-58	Pliers Mask for PZ-58
PH-55	Combination Scissors GT

Item No.	Case Size	Wgt.
PGT-03	252×132×32mm	372g

Item No.	Case Size	Wgt.
PDS-01	300×63×200mm	896g

DBZ-60G**RoHS RAPID SCREW EXTRACTOR**

The unique extracting tool, especially designed to remove damaged countersunk screws!

- Special screw driver for screw extraction
- No power supply or drilling required
- 2 bits for more possibilities
- High-torque handle grip
- Shock-absorbable rubber sleeve included

Contents:

- Handle Grip for DBZ(Green)(DBZ-50G)
- ⊕#2 Press & Twist type bit (DBZ-51)
- ⊕#2 Strike & Turn type bit (DBZ-52)
- Rubber Sleeve for DBZ-52

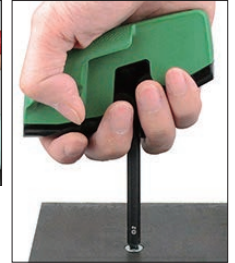
PRODUCT VIDEO

Handle grip



DBZ-52

DBZ-51

Item No.	Material	Wgt.
DBZ-60G	Bit: Carbon Steel Sleeve: TPR Grip: ABS, Nylon	135g

DBZ-50B**HANDLE GRIP FOR DBZ(BLACK)**

High-torque handle grip



Item No.	Material	Width	Wgt.
DBZ-50B	Grip: ABS, Nylon	100mm	83g

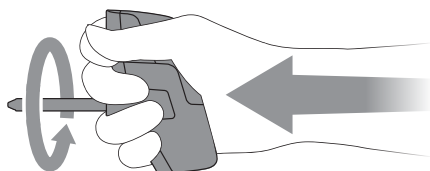

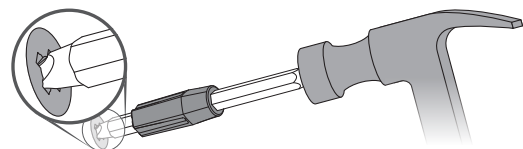

How to**Press & Twist type** (for slightly damaged screws)

- 1) Insert the bit into the handle grip.
- 2) Place the bit tip into the screw head, then scrape away burrs in the recess by twisting it back and forth lightly.
*Do not attempt to hit the bit with a hammer.
- 3) After you feel the bit tip catches the corner of recess, give a jerk counterclockwise while pressing firmly downward.

**Strike & Turn type** (for heavily damaged screws)

- 1) Clean out any steel chips left in the screw recess.
- 2) Fix the rubber sleeve to the Strike & Turn bit and position the tip in the recess.
- 3) Strike the end of the bit with a hammer to stick the tip into the recess.
- 4) Make sure the bit is self-standing upright, and then affix the grip onto the bit.
*Do not hit the grip with a hammer.
- 5) Give a jerk counterclockwise while pressing firmly downward.



Press & Twist type	Strike & Turn type
 <p>Slightly damaged Philips screws</p> <ul style="list-style-type: none"> DBZ-51 DBZ-57 	 <p>Heavily damaged Philips screws</p> <ul style="list-style-type: none"> DBZ-52
 <p>Slightly damaged Hex screws</p> <ul style="list-style-type: none"> DBZ-62 DBZ-63 DBZ-64 DBZ-65 	 <p>Heavily damaged Hex screws</p> <ul style="list-style-type: none"> DBZ-53 DBZ-54 DBZ-56

Item No.	Screw type/size	Bit type	Length	Wgt.
DBZ-51	⊕#2	Press & Twist type	105mm	27g
DBZ-52		Strike & Turn type		
DBZ-53	Hex socket screw (●: 2.5-3.0mm)	Strike & Turn type		26g
DBZ-54	Hex socket screw (●: 4.0mm)	Strike & Turn type		
DBZ-56	Hex socket screw (●: 5.0mm)	Strike & Turn type		
DBZ-57	⊕#1	Press & Twist type		25g
DBZ-62	Hex socket screw (●: 2.0mm)	Press & Twist type		
DBZ-63	Hex socket screw (●: 2.5-3.0mm)	Press & Twist type		
DBZ-64	Hex socket screw (●: 4.0mm)	Press & Twist type		
DBZ-65	Hex socket screw (●: 5.0mm)	Press & Twist type		27g

PRODUCT VIDEO

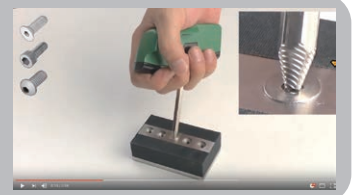

DBZ-62~65 can be used with your power driver

Screw types

Countersunk

Pan head

Dome head

Hex

(Unit in mm)



Scissors

PH-57•PH-57R•PH-57G•PH-57Y

COMBINATION SCISSORS DP

- 2-in-1 anti-slip serrations and U-shaped blade
- 3mm-thick durable blades, made of stainless steel



Micro-serrations

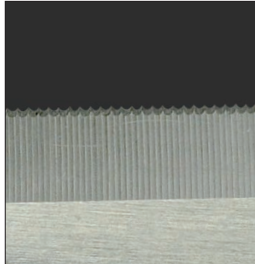

Hold the object without slippage such as Aramid fiber, plastic plate, etc.

U-shaped blade

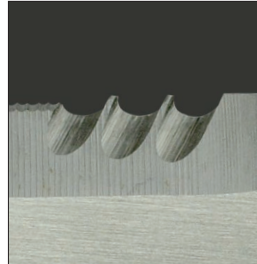

Ideal for power supply cord, coaxial cable, rope, etc.

TPR cushioned handles



Comfort gripping

Finger pinch guard



The overlapping guard prevents your fingers from being pinched [PAT.]

Cutting capacity (Reference only)

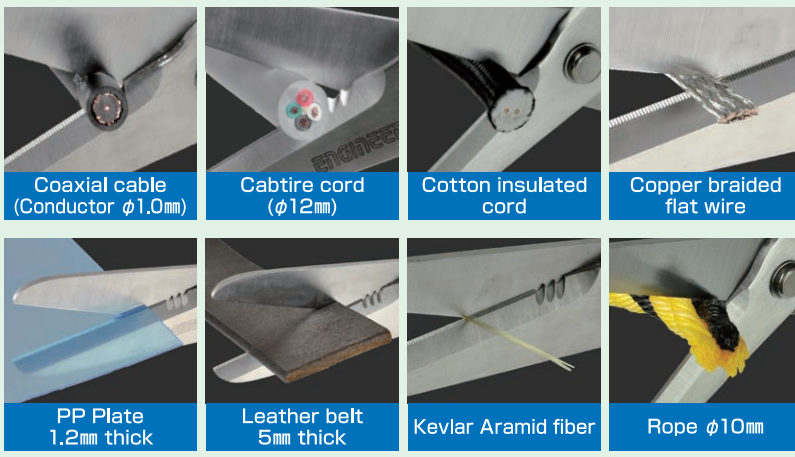

※Do not apply Copper or Steel wire to the Micro-serration to keep the life of main blades.
 ※Heat-treated or specially-hardened wire is not applicable for cutting. It may damage the blades.

Color variations

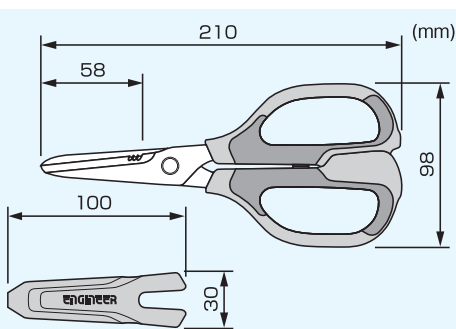

Item No.	Size	Hardness	Material	Wgt.
PH-57	210mm	HRC56±2	Blades: Stainless Steel Handles: ABS & TPR Cap: ABS	136g
PH-57R				
PH-57G				
PH-57Y				

SCREW REMOVAL

SCISSORS

NIPPERS

PLIERS

CRIMPING STRIPPING

TWEEZERS

SCREW DRIVERS

SPECIAL DRIVERS

WRENCHES

CUTTING PROCESSING

SETS CASES

SOLDERING EQUIPMENT

ESD CHEMICALS

PH-56R·PH-56G·PH-56Y

COMBINATION SCISSORS MP

- 2-in-1 anti-slip serrations and U-shaped blade
- 2.5mm-thick blades, made of stainless steel



Nano-serrations



Hold the object without slippage such as Aramid fiber, plastic plate, etc.

U-shaped blade

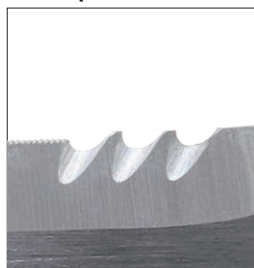

Ideal for power supply cord, coaxial cable, rope, etc.

Finger pinch guard

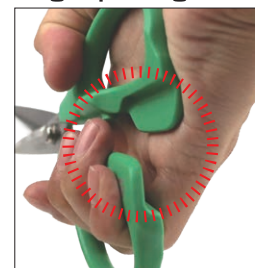

The overlapping guard prevents your fingers from being pinched **[PAT.]**

Cutting capacity (Reference only)

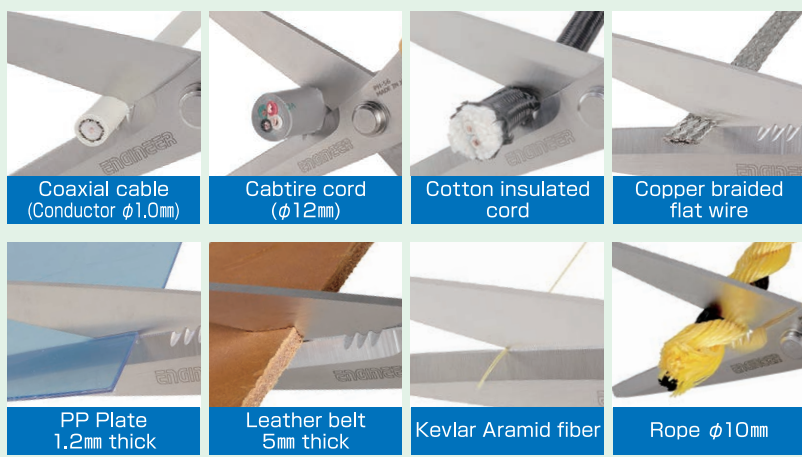

Color variations



※Do not apply Copper or Steel wire to the Micro-serration to keep the life of main blades.
 ※Heat-treated or specially-hardened wire is not applicable for cutting. It may damage the blades.

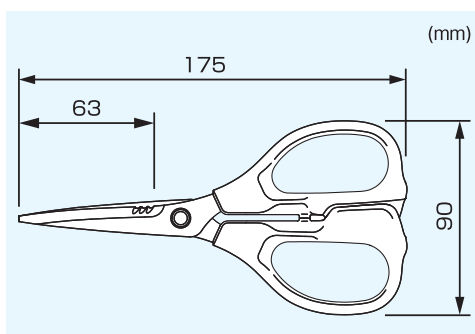

Item No.	Size	Hardness	Material	Wgt.
PH-56R	175mm	HRC56+2	Blades: Stainless Steel Handles: ABS	75g
PH-56G				
PH-56Y				

PH-50

COMBINATION SCISSORS

2-in-1 Unique cutting blade

- Trimming various objects which you could not cut with ordinary scissors such as nylon fiber, cabtire cord, etc.
- Fine and flush cut in finish even compared with cut with cutting pliers
- Ideal for professional electricians as well as for hobby use.

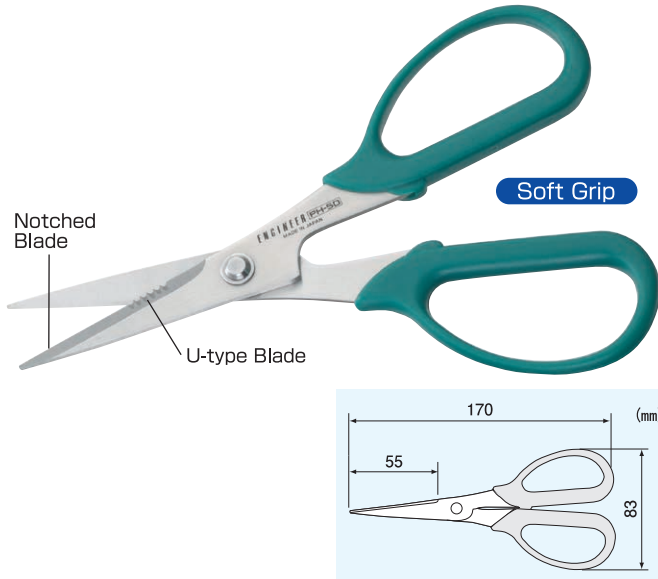

Notched Blade

Notched blades prevent the object from slipping



Trimming Nylon or Kevlar fiber without slipping



Copper braided flat wire



Aluminum sheet

PH-50 Notched Blade Cutting Capacity

Nylon/Kevlar fiber	Various types
Copper braided wire	0.5mm max.
Aluminum/Copper sheet	1.0mm max.
Plastic plate / PET	1.0mm max.

U-type Blade



U-type notches hold cord firmly

Sharp cut against insulated cord with rubber or cotton braided

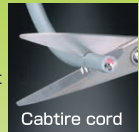

Cabtire cord

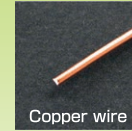

Copper wire

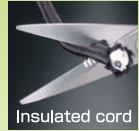

Insulated cord

PH-50 U-type Blade Cutting Capacity

Copper wire	φ1.5mm max.
Cabtire cord	Various types
Cotton braided cord	
Cotton insulated cord	

*Do not use U-type blade for cutting Aluminum or Copper sheet, which may damage the blade.

Item No.	Size	Hardness	Material	Wgt.
PH-50	170mm	HRC54±2	Handles:PE Blades:Stainless Steel	58g

PH-55

COMBINATION SCISSORS GT

4-in-1 Blade combination, Compact Body to Generate More Force!!

- Cut various materials cleanly
- Safely-designed and comfortable handles
- Blade cap with vent & drain holes
- Rust proof stainless steel body
- Applicable to professional users and hobbyist

Anti-slip Handle



You can grasp the outer rim of the handles safely when the work requires a strong grip.



Micro-serration



Holds the object without slipping

Finger Pinch Guard



The overlapping guard prevents your fingers being pinched in the handles. **[PAT.]**

Flat Blade



Smooth cutting not only of cloth but also of paper



S-shaped Design

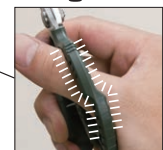

The unique form transmits gripping power efficiently to the shears.

Wire Cutter



Handy cutting blades for copper or steel wire

Safety Box Opener



Convenient to open carton boxes with ease

Cutting Capacity (Reference)

Micro-serration		Wire Cutter	
Rope	Cabtire cord	Cotton insulated	Copper wire
φ10mm	φ9mm	φ8mm	φ1.6mm
Leather belt	CD-Card	Carpet	Wire
4mm thick	1.2mm thick	5mm thick	φ1.2mm

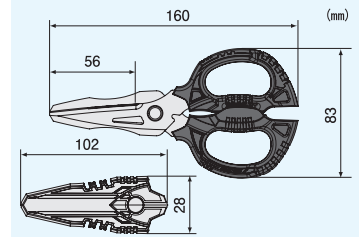

Item No.	Size	Hardness	Material	Wgt.
PH-55	160mm	HRC56±2	Handles:PBT Blades:Stainless Steel	120g

*Do not apply Copper or Steel wire to the Micro-serration to keep the life of main blades.
*Heat-treated or specially-hardened wire is not applicable for cutting. It may damage the blades.

SCREW REMOVAL

SCISSORS

NIPPERS

PLIERS

CRIMPING STRIPPING

TWEEZERS

SCREW DRIVERS

SPECIAL DRIVERS

WRENCHES

CUTTING PROCESSING

SETS CASES

SOLDERING EQUIPMENT

ESD CHEMICALS

PH-33·34

RoHS ELECTRONIC SNIPS

- Ideal for delicate cutting for PCB related work.
- PH-33 (straight) / PH-34 (curved)
- Length: 145mm
- Material: Stainless Steel
- Serrated shears for anti-slipping



PK-50·51

RoHS CABLE SHEARS

- Makes a fine cut surface owing to the curved blades
- High leverage for easy operation

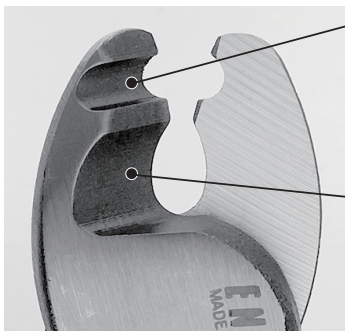
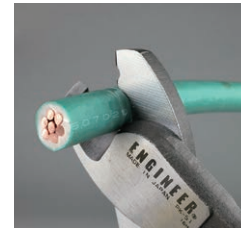

■ Foremost Blades
Wire cutter suitable for copper wires

■ Main Blade (Rearmost)
Curved blades suitable for insulated cables, make a fine cut surface. Flat cables, Coaxial cables, Power supply cords, LAN cables, etc. are also applicable.

Comparison of Cut Surface

Cable Shears

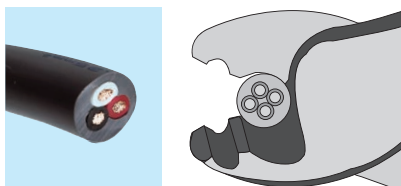

The curved blades can hold a cable securely and the shears mechanism enables you to make a cut surface finely.

Conventional Pliers

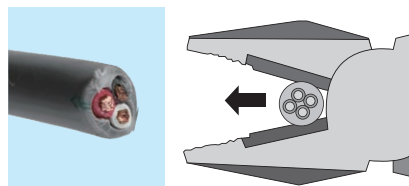

The pressure given from flat blades crushes a cable or it may slip sideways.

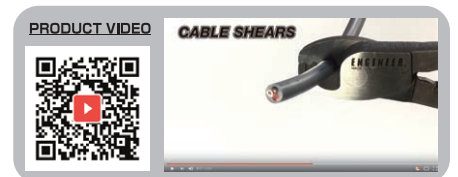

Item No.	Size	Hardness	Cutting Capacity		Wgt.	
			Vinyl insulated Cable	Flat Cable		
PK-50	164mm	HRC58±4	9mm outside diameter	22 mil	2.0mm×2core	150g
PK-51	212mm	HRC58±4	11mm outside diameter	38 mil	2.0mm×3core	250g

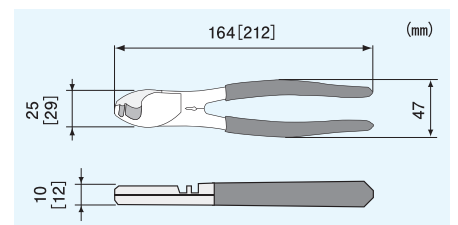

[]:PK-51

Nippers



NS & NZ SERIES

Features

- Our micro nippers are ideal for precise PCB work.
- Made of special steel and specially heat treated for excellent cutting capacity and durability.
- Full-flush cutting edge recommended for cutting copper and soft lead wires.
- Soft touch grip insulation and spring ensure long comfortable work.



- With opening angle adjuster or stopper

NS-03

RoHS MICRO NIPPERS

- Ideal for small PCB related work
- With opening angle adjuster
- Material: S58C
- Hardness: HRC 58±4
- Capacity: copper wire ϕ 1.4mm

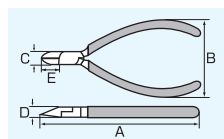

Size	A	B	C	D	E
125	128	52	13	7	14

NS-04

RoHS MICRO NIPPERS

- Ideal for small PCB related work
- With opening angle adjuster
- ESD-Safe handles made of Elastomer (TPR)
- Material: S58C
- Hardness: HRC 58±4
- Capacity: copper wire ϕ 1.2mm

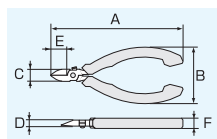

Size	A	B	C	D	E	F
115	120	50	13	7	14	11

NSX-04

RoHS MICRO NIPPERS

- Cost-saving simple structure
- With side stopper
- Material: S58C
- Hardness: HRC 58±4
- Capacity: copper wire ϕ 1.2mm
- Especially for production line owing to economical and ecology package in poly bag

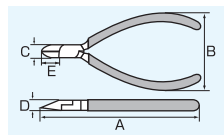

Size	A	B	C	D	E
115	117	51	13	7	14

NS-06

RoHS MICRO NIPPERS

- Undercut design featuring thin blade
- Ideal for precise PCB related work
- With opening angle adjuster
- Material: S58C
- Hardness: HRC 58±4
- Capacity: copper wire ϕ 0.8mm

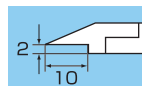

Under cut

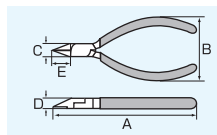

Size	A	B	C	D	E
105	107	48	10	7	10

■ Nippers cutting capacities (Reference only)

Item No.	Commodity	Size	Copper wire		Steel wire (ϕ)	Others	Page
			Solid (ϕ)	Stranded			
NS-03	Micro Nippers	125	1.4	2			16
NS-04	Micro Nippers	115	1.2	2			16
NSX-04	Micro Nippers	115	1.2	2			16
NS-06	Micro Nippers	105	0.8				16
NZ-03	Chip Cutter	125	0.6				17
NZ-05	Chip Cutter	125	0.6			also applicable to plastic gate	17
NZ-12	Parallel Nippers	125	0.6				17
NZ-13	Parallel Nippers	125	0.6				17
NP-03	Plastic Nippers	125				Injection molding gate ϕ 3mm	19
NP-04	Plastic Nippers	150				Injection molding gate ϕ 3mm	19
NP-05	Plastic Nippers	115	0.8			Injection molding gate ϕ 3mm	19
NK-15	Diagonal Nippers	125	2.6	2	1.5		18
NK-16	Diagonal Nippers	150	3	2	1.9		18
NK-25	Diagonal Nippers	125	2.6	2	1.5	Stripping hole ϕ 1.2 & 1.6mm	18
NK-26	Diagonal Nippers	150	3	2	1.9	Stripping hole ϕ 1.2 & 1.6mm	18
NK-36	Diagonal Nippers	150	3.2		2	Vinyl insulated cable ϕ 1.6mm	18
NN-45	Slant Edge Nippers	125	2	2	1.2	Stripping hole ϕ 1.2 & 1.6mm	19
NN-46	Slant Edge Nippers	150	2.6	2	1.4	Stripping hole ϕ 1.2 & 1.6mm	19
NN-56	Slant Edge Nippers	150	2.6	2	1.4		19

NZ-03

iRoHS CHIP CUTTER

- Opening angle adjuster (Max. 5mm) with 1.5mm hex key wrench included
- Sharp & slender design of jaws for work on dense circuit board
- ESD-Safe handles made of Elastomer (TPR)
- Material: S58C
- Hardness: HRC 58±4
- Capacity: copper wire $\phi 0.6\text{mm}$
- Applications: Removal of chip resistance, IC, etc. on SMD

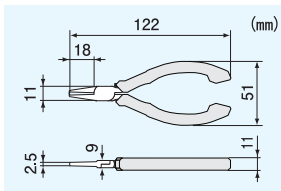

NZ-05

iRoHS CHIP CUTTER

- Opening angle adjuster (Max. 5mm) with 1.5mm hex key wrench included
- Sharp & slender design of jaws for work on dense circuit board
- ESD-Safe handles made of Elastomer (TPR)
- Material: S58C
- Hardness: HRC 58±4
- Capacity: copper wire $\phi 0.6\text{mm}$
- Applications: Leads of Dual In-line Package or Single In-line Package IC on SMD

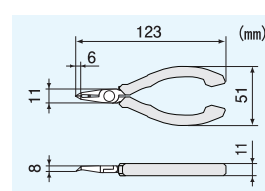

NZ-12·13

iRoHS PARALLEL NIPPERS

Full flush & super-fine cutting edge

- Ideal to cut an IC lead of a narrow-pitch QFP or SOP with slender shears (0.3mm+0.3mm width at top)
- Ergonomic elastomer handle for comfort gripping
- Cutting capacity : Copper wire $\phi 0.6\text{mm}$
- Light weight of 45g only

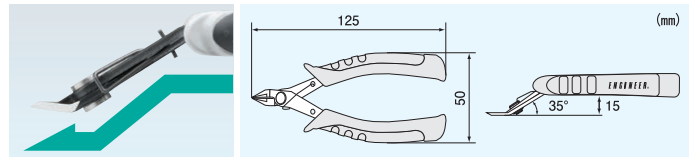

SHEARS & GRIP IN PARALLEL



NZ-12



NZ-13

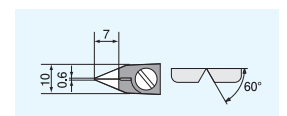
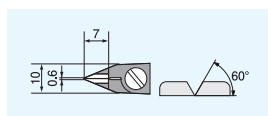

NZ-12 : Normal Blade
Enables you to make flush cut of a lead easily so as to prevent resist stripping or solder crack on the circuit board



NZ-13 : Reverse Blade
Enables you to cut IC lead in front of user with the best view while holding nippers vertically against circuit board

SCREW REMOVAL

SCISSORS

NIPPERS

PLIERS

CRIMPING STRIPPING

TWEEZERS

SCREW DRIVERS

SPECIAL DRIVERS

WRENCHES

CUTTING PROCESSING

SETS CASES

SOLDERING EQUIPMENT

ESD CHEMICALS

NK-15·16



DIAGONAL NIPPERS

Sharp & durable cutting for precision wiring work

- With opening angle adjuster & coiled spring
- Material: S55C
- Hardness: HRC 58±4
- Capacity (copper wire) : NK-15 ϕ 2.6mm
NK-16 ϕ 3mm

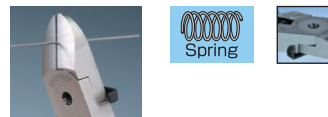

NK-15

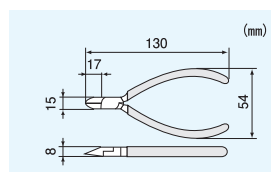

NK-16

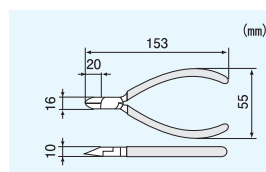

NK-25·26



DIAGONAL NIPPERS

Precision cutter with wire stripper

- With opening angle adjuster & coiled spring
- Stripping holes: ϕ 1.2 & 1.6mm
- Material: S55C
- Hardness: HRC 58±4
- Capacity (copper wire) : NK-25 ϕ 2.6mm
NK-26 ϕ 3mm

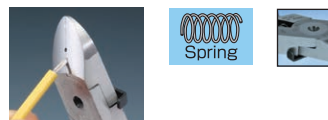

NK-25

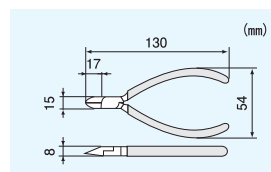

NK-26

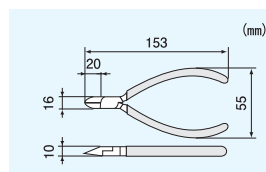

NK-36



HEAVY DUTY DIAGONAL NIPPERS

Heavy-duty durable cutter

- Material: S58C
- Hardness: HRC 60±4
- Capacity: copper wire ϕ 3.2mm

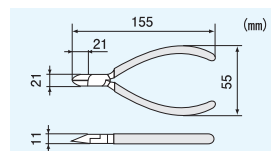

NN-45·46  **SLANT EDGE NIPPERS**

Professional type for sharp & easy use 

- Stripping holes: ϕ 1.2 & 1.6mm
- Material: S58C
- Hardness: HRC 58 \pm 4



NN-45



Item No.	Size	A	B	C	D	E	Capacity
NN-45	125	133	51	14	10	23	copper wire ϕ 2mm
NN-46	150	159	51	16	11	26	copper wire ϕ 2.6mm

(mm)

NN-56  **SLANT EDGE NIPPERS**

Sharp cutting & easy handling 

- Material : S58C
- Hardness : HRC 58 \pm 4
- Capacity : copper wire ϕ 2.6mm

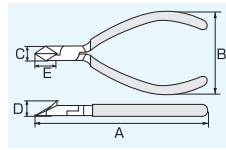

Size	A	B	C	D	E
150	159	51	16	11	26

(mm)

NP-03·04  **PLASTIC NIPPERS**

- Ideal for cutting plastic mold gates & burns
- With opening angle adjuster & coiled spring
- Material: S58C
- Hardness: HRC 58 \pm 4



NP-03



NP-04

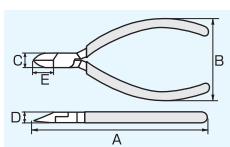

Item No.	Size	A	B	C	D	E
NP-03	125	130	54	14	8	17
NP-04	150	152	55	16	10	20

(mm)

NP-05  **PLASTIC NIPPERS**

Tapered and slender head for work in restricted area

- Ideal for cutting and trimming various gates of injection molding
- Also capable of cutting thin copper wire (ϕ 0.8mm max.)
- ESD-Safe handles made of Elastomer (TPR)
- With side stopper & coiled spring
- Material: S58C
- Hardness: HRC 59 \pm 3



NP-05

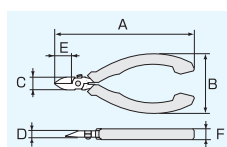

Item No.	Size	A	B	C	D	E	F
NP-05	115	123	52	11	7	12	11

(mm)

SCREW REMOVAL

SCISSORS

NIPPERS

PLIERS

CRIMPING STRIPPING

TWEEZERS

SCREW DRIVERS

SPECIAL DRIVERS

WRENCHES

CUTTING PROCESSING

SETS CASES

SOLDERING EQUIPMENT

ESD CHEMICALS

Pliers



PS-01

RoHS MINIATURE LONG NOSE PLIERS

Ideal for precision work

- Jaws with inside serration
- Material: S58C
- Hardness: HRC 58±4
- Capacity: copper wire $\phi 2\text{mm}$

Point section

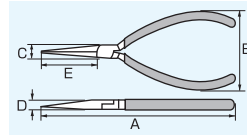

Item No.	Size	A	B	C	D	E
PS-01	125	132	51	14	8	37

SCREW REMOVAL

SCISSORS

NIPPERS

PLIERS

PS-03

RoHS MINIATURE NEEDLE NOSE PLIERS

Ideal for forming work

- Jaws without serration
- ESD-Safe handles made of Elastomer (TPR)
- Material: S58C
- Hardness: HRC 46±4



Point section



CRIMPING STRIPPING

TWEEZERS

SCREW DRIVERS

SPECIAL DRIVERS

PS-04

RoHS MINIATURE FLAT NOSE PLIERS

- Jaws without serration
- ESD-Safe handles made of Elastomer (TPR)
- Material: S58C
- Hardness: HRC 46±4



Point section

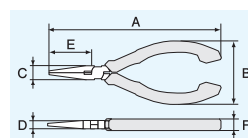
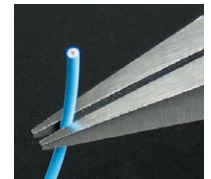

Item No.	Size	A	B	C	D	E	F
PS-03	125	141	55	11	8	38	11
PS-04	125	132	50	11	8	29	11

WRENCHES

CUTTING PROCESSING

SETS CASES

SOLDERING EQUIPMENT

ESD CHEMICALS

PL-05 · 06  **LONG FLAT NOSE PLIERS**

Thin and flat edge for efficient work

- Jaws without serration
- Long-life box joint structure to avoid loosening
- Material: Stainless steel

Point section

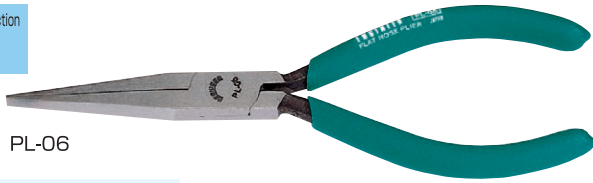

PL-06

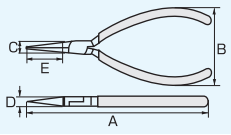

Item No.	SIZE	A	B	C	D	E
PL-05	125	143	50	11	7	40
PL-06	150	164	53	15	10	43

PM-06  **ROUND NOSE PLIERS**

Ideal for looping & coiling of steel wires

- Material: SCM440H

Point section

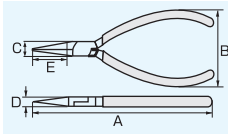
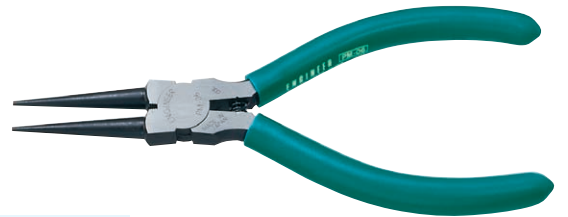

SIZE	A	B	C	D	E
150	145	53	15	8	35

PR-15 · 16  **LONG NOSE PLIERS**

General purpose pliers



- Material: S58C
- Hardness: HRC 58±4

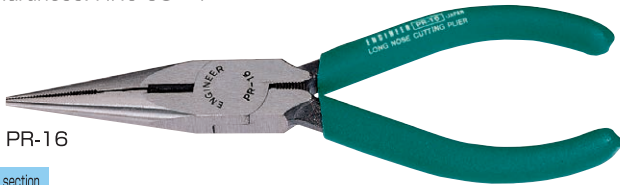

PR-16

Point section



Item No.	SIZE	A	B	C	D	E	Capacity
PR-15	125	142	51	17	10	43	Copper wire ϕ 2.0mm
PR-16	150	160	55	17	10	49	Copper wire ϕ 2.6mm

PR-26  **LONG NOSE PLIERS**

Professional type pliers



- Material: S58C
- Hardness: HRC 58±4
- Capacity: copper wire ϕ 2.6mm

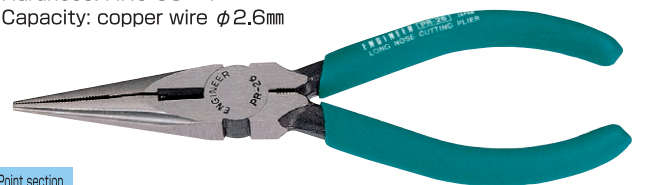

Point section



SIZE	A	B	C	D	E
150	160	52	17	10	50

PR-36  **LONG NOSE PLIERS**

Multipurpose pliers with gripping jaws, cutter & wire stripper



- Stripping Hole: ϕ 1.2mm
- Material: S58C
- Hardness: HRC 58±4
- Capacity: copper wire ϕ 2.6mm

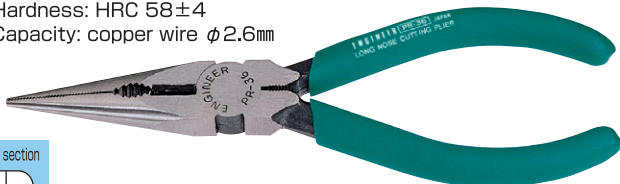

Point section



SIZE	A	B	C	D	E
150	160	51	17	10	50

PR-46  **NEEDLE NOSE PLIERS**

50mm-long slender nose ideal for work in deep area

- Material: S58C
- Hardness: HRC 58±4
- Capacity: copper wire ϕ 2.6mm



Point section

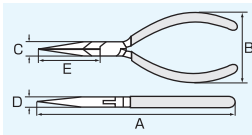

SIZE	A	B	C	D	E
160	160	51	13	8	50

PD SERIES

Features ● Durably constructed Electrician's Pliers

PD-06~08

 **SIDE CUTTING PLIERS**

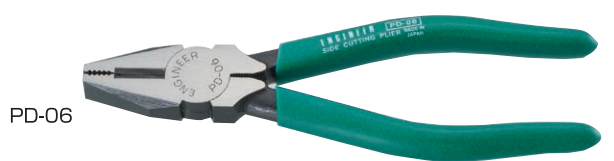

PD-06



PD-07



Heavy duty professional-use pliers

- Material: S58C
- Hardness: HRC 60±4

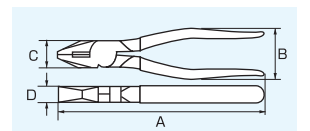

Item No.	Size	A	B	C	D	Capacity
PD-06	150	165	50	22	12	steel wire ϕ 1.6
PD-07	175	185	52	24	13	steel wire ϕ 1.8
PD-08	200	210	53	27	14	steel wire ϕ 2.0

PC & PW SERIES

Features ● Slip Joint Pliers and Groove Joint Pliers for maintenance and general purpose

PC-06·08 COMBINATION PLIERS

- Slip joint for wide-open jaws
- Material: S55C



PC-06



PC-08

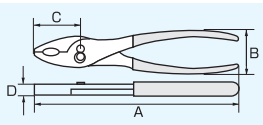

Item No.	Size	A	B	C	D	(mm)
PC-06	150	165	45	42	9	
PC-08	200	203	48	46	11	

PW-05~10 WATER PUMP PLIERS

- Groove-joint leverage for heavy duty work
- Serrated jaws with soft-touch grip
- Material: S55C



PW-05



PW-08

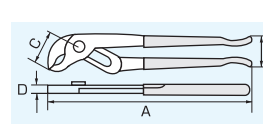

Item No.	Size	A	B	C	D	Max. Opening	(mm)
PW-05	125	127	34	25	5.5	15	
PW-08	200	200	37	38	8	33	
PW-10	250	250	38	50	11	45	

PZ-01·02

E-RING PLIERS

Ideal and smart pliers to remove and fasten E-ring!!

- Place the corner of E-ring into the recess of pliers' jaw for removal, fastening and replacement work.
- Magnetized point for convenient holding
- Long-life box joint structure to avoid loose joint
- Material : Stainless steel



Box joint



PZ-01

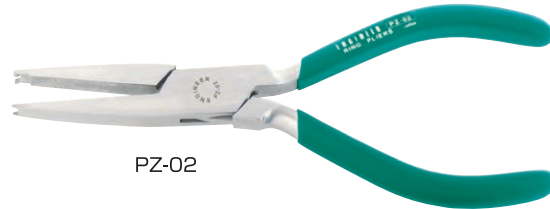
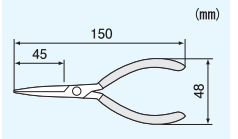

PZ-02

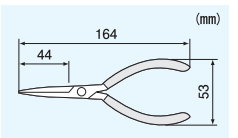

Item No.	Ring Size	O.A. Length	(mm)
PZ-01	φ3~4	150	
PZ-02	φ5~9	164	



Ring Size

The Ring Size shown above is the diameter of grooved shaft to which E-ring retains.

PZ-16~19

SNAP RING PLIERS

- Slender design of jaws ideal for work at a confined area
- The spiked tips are angled outward (PZ-16&17) or inward (PZ-18&19) to hold a snap ring securely without slippage.
- Spring built into the joint screw for smooth and repeated work
- Material: Carbon steel



PZ-16



PZ-18



External ring type



Internal ring type

Item No.	Applicable Ring Size	Tip Diameter	Ring Type	Wgt.	(mm)
PZ-16	#10-25mm	φ1.3mm	External ring	90g	
PZ-17	#19-60mm	φ1.8mm		175g	
PZ-18	#10-25mm	φ1.1mm	Internal ring	90g	
PZ-19	#19-60mm	φ1.8mm		175g	

SCREW REMOVAL

SCISSORS

NIPPERS

PLIERS

CRIMPING STRIPPING

TWEEZERS

SCREW DRIVERS

SPECIAL DRIVERS

WRENCHES

CUTTING PROCESSING

SETS CASES

SOLDERING EQUIPMENT

ESD CHEMICALS

Crimping and Stripping



WIRE PLIERS SERIES

Features ● General purpose & compact wire pliers used for crimping, stripping & cutting for precision wiring work.

PA-01

RoHS WIRE PLIERS

- Six-in-one multipurpose type.
- For bare, insulated terminals & splices (open barrels).
- O.A. length: 245mm.
- Weight: 250g

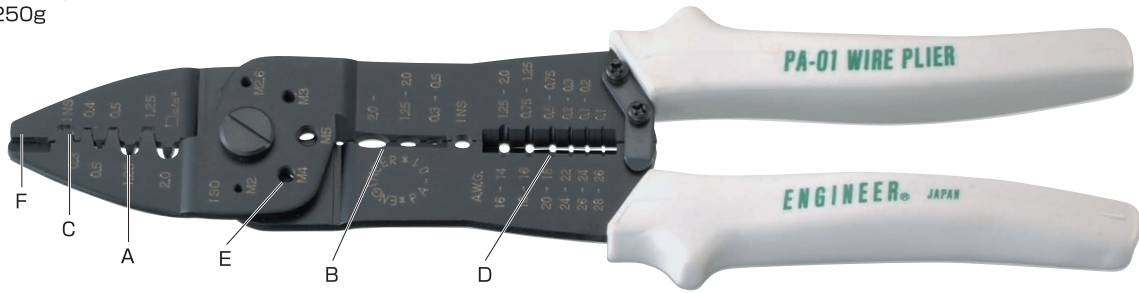

PA-03

RoHS WIRE PLIERS

- For splices (open barrel terminals) with wire stripper & bolt cutter.
- O.A. Length: 210mm.
- Weight: 205g

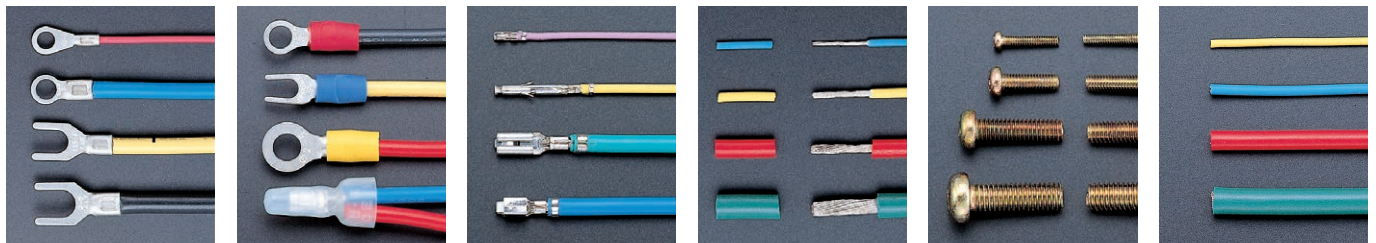
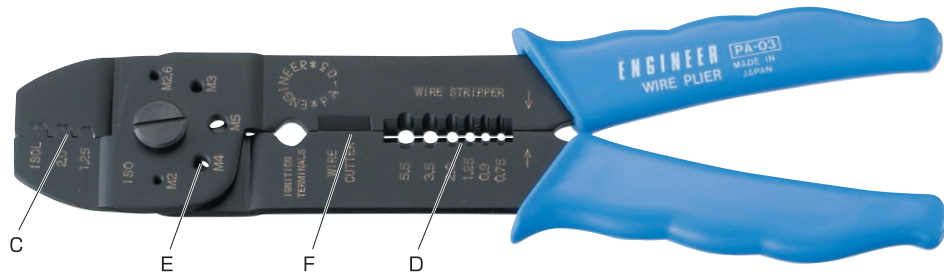

A. For crimping BARE terminals. B. For crimping INSULATED terminals. C. For crimping OPEN BARREL(SPLICES) terminals. D. For stripping insulated WIRES. E. For cutting SCREWS. F. For cutting WIRES.

Item No.	(mm ²)					
	A	B	C	D	E	F
PA-01	Bare terminals' crimping 0.5 ~2.0	Insulated terminals' crimping 0.3 ~2.0	Splices' crimping 0.3 ~1.25	Wires' stripping 0.1 ~2.0	Small screw's cutter(ISO) M2, M2.6, M3, M4, M5	Wires' cutting ○
PA-03	-	-	1.25~2.0	0.75~5.5	M2, M2.6, M3, M4, M5	○

Conversion A.W.G. table

AWG	8	10	12	14	16	18	20	22	24	26	28	30
Sectional area mm ²	8.37	5.26	3.31	2.08	1.31	0.82	0.52	0.33	0.20	0.13	0.08	0.05
Wire diam mm	3.26	2.59	2.05	1.63	1.29	1.02	0.81	0.64	0.51	0.40	0.32	0.25

How to select the proper dies for crimping an open-barrel contact

1. Measure the width of conductor barrel with a caliper while both barrel wings are in parallel.



2. Select the die width which is close to the width of barrel wings measured.

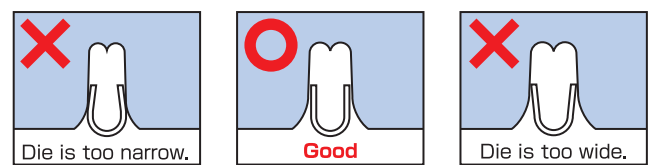

For example: 1.5mm measured → Select 1.6mm dies.

Turn to page 26 for Crimping Pliers →

CONNECTOR CRIMPING PLIERS

Features

- Our line-up offers you very precise and perfect crimp finish of open-barrel contacts.
- ENGINEER original joint-screw prevents the joint from being loose and realizes easy maintenance.
- Pliers made of S55C high carbon steel for durability
- With locking latch and coiled spring, Light weight for fatigue-free work

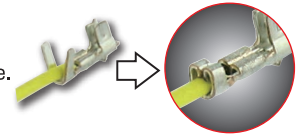

PA-09



MICRO CONNECTOR PLIERS

Crimp AWG #32 to #20 wires in micro connectors of different makers!!

- 4 different crimping dies, 1.0, 1.4, 1.6 & 1.9mm(W)
- Makes it possible to crimp 1.25 to 2.5mm pitch connector pin (Narrow pitch)
- D-sub connector contacts also adaptable
- Weight: 145 g



■ Typical terminals applicable

PH Series(JST)	ZH Series(JST)	Molex 170363(Molex)
EH Series(JST)	NH Series(JST)	Molex 170365(Molex)

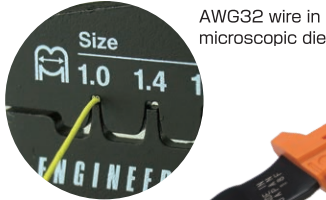

AWG32 wire in microscopic die

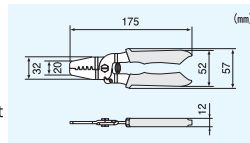

■ Specifications

Item No.	Die Width (mm)	Die Height (mm)	Die Thickness (mm)	Wires applicable (Reference only)		
				φ mm	mm	AWG (conductor)
PA-09	1.0	0.50	1.7	0.20~0.32	0.031~0.08	#32~#28
	1.4	0.55		0.32~0.51	0.08~0.21	#28~#24
	1.6	0.8	2.0	0.51~0.64	0.21~0.33	#24~#22
	1.9	0.9		0.51~0.81	0.21~0.52	#24~#20

PA-20



UNIVERSAL CRIMPING PLIERS

Crimp AWG #28 to #18 wires in micro connectors of different makers!!

- 4 different crimping dies, 1.6, 1.9, 2.0 & 2.3mm(W)
- Makes it possible to crimp 2.5 to 5mm pitch connector pin (Universal type)
- Weight: 145 g



■ Typical terminals applicable

VH Series(JST)	NH Series(JST)	PH Series(JST)
EL Series(JST)	3191 Series(Molex)	MATE-N-LOK(Tyco)

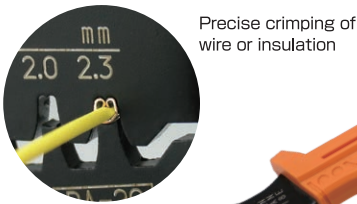

Precise crimping of wire or insulation

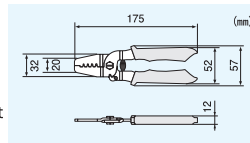

■ Specifications

Item No.	Die Width (mm)	Die Height (mm)	Die Thickness (mm)	Wires applicable (Reference only)		
				φ mm	mm	AWG (conductor)
PA-20	1.6	0.7	2.5	0.32~0.64	0.08~0.33	#28~#22
	1.9	0.8		0.51~0.81	0.21~0.52	#24~#20
	2.0	0.9		0.64~1.02	0.33~0.82	#22~#18
	2.3	1.0		0.81~1.02	0.52~0.82	#20~#18

PA-21



UNIVERSAL CRIMPING PLIERS

Precise crimpers for wide range of open-barrel contacts including long barrel wing type

- 4 different crimping dies, 1.6, 1.9, 2.2 & 2.5mm(W)
- Crimping AWG #26~18 contacts of different connector makers
- Weight: 145 g



Long wing type is also adaptable.

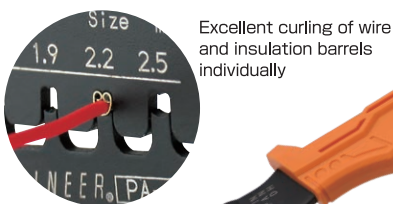

Excellent curling of wire and insulation barrels individually

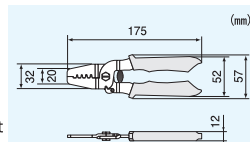

■ Typical terminals applicable

XH Series(JST)	NH Series(JST)	VH Series(JST)
PA Series(JST)	Mini Fit(Molex)	Universal MATE-N-LOK(Tyco)

■ Specifications

Item No.	Die Width (mm)	Die Height (mm)	Die Thickness (mm)	Wires applicable (Reference only)		
				φ mm	mm	AWG (conductor)
PA-21	1.6	0.8	1.8	0.41~0.51	0.13~0.21	#26~#24
	1.9	1.0		0.41~0.64	0.13~0.33	#26~#22
	2.2	1.2		0.51~0.81	0.21~0.52	#24~#20
	2.5	1.4		0.64~1.02	0.33~0.82	#22~#18

PRECISE CRIMPING SERIES - Tool Frame and Die Set

PAD-11~13

IRoHS HANDY CRIMP TOOL

Ultra-precise crimper forming excellent crimping finish

- Interchangeable die set for open-barrel contacts. Easy replacement and perfect fitting to the frame
- Ergonomically-designed handles with strap hole
- Equipped with wire stripper and cutter, spring loaded
- Standard accessory : Hex key wrench ● 2.5mm
- Material :
Frame & Die set – Special alloy steel
Handles – Elastomer (TPR)

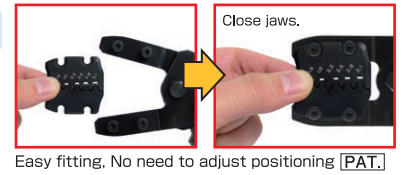

PAD-11 (S Size)

Loosen the cap screws with a hex key wrench to replace the die set.

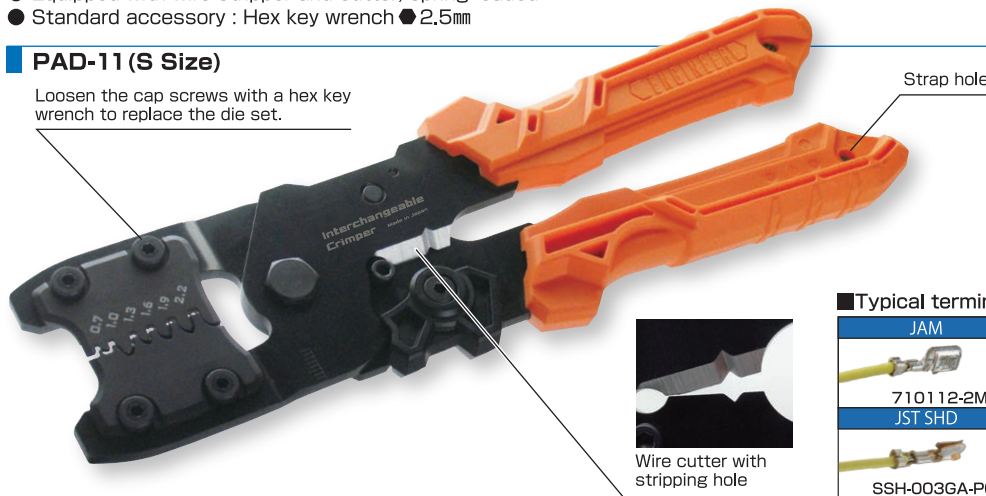

Typical terminals applicable

JAM	Molex CLIK-Mate	Tyco D-1000
710112-2MAC	502381	1827586-2
JST SHD	Molex PicoBlade	Tyco D-1000
SSH-003GA-P0.2	50079	1827587-2

PAD-12 (M Size)



Typical terminals applicable

JST NH	Molex New Mini Fit	Tyco D-3000
SHF-001T-0.8BS	5556T	175217-2
JST VH	Molex New Mini Fit	Tyco D-3000
SVH-21T-P1.1	5558T	175288-2

PAD-13 (L Size)



Typical terminals applicable

JST VL	Molex 3191	Tyco D-3000
BVF-42T-P2.0	1189T	175218-2
JST VL	Molex 3191	Tyco D-3000
BVF-61T-P2.0	1190T	175289-2

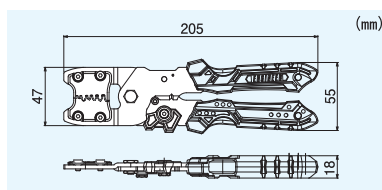

Crimper size

Item No.	PAD-11										
	PAD-12						PAD-13				
	0.7	1.0	1.3	1.6	1.9	2.2	2.5	2.8	3.1	3.4	3.7
Die width	0.7	1.0	1.3	1.6	1.9	2.2	2.5	2.8	3.1	3.4	3.7
Die thickness	1.0		1.5		2.0		2.5		3.0		3.5

PAD-11S~13S

IRoHS INTERCHANGEABLE DIE SET

PAD-11S (S Size)

- Over 90 different terminals applicable



PAD-12S (M Size)

- Over 110 different terminals applicable



PAD-13S (L Size)

- Over 100 different terminals applicable

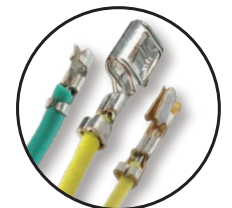

Frame & Dies Combination

Item No.	Frame	Die set
PAD-11	PAD-10	+ PAD-11S
PAD-12	PAD-10	+ PAD-12S
PAD-13	PAD-10	+ PAD-13S

Crimper size

Item No.	PAD-11S						PAD-12S				
	PAD-13S										
	0.7	1.0	1.3	1.6	1.9	2.2	2.5	2.8	3.1	3.4	3.7
Die width	0.7	1.0	1.3	1.6	1.9	2.2	2.5	2.8	3.1	3.4	3.7
Die thickness	1.0		1.5		2.0		2.5		3.0		3.5

PAD-02  **HANDY CRIMP TOOL COMPLETE SET**

- Comes with 3 different interchangeable Die Sets
- Tool Frame & Parts Boxes in a stylish carrying case



■ Set Content

Item No.	Description	
PAD-11	Handy Crimp Tool	
PAD-12S	Interchangeable Die Set (M Size)	
PAD-13S	Interchangeable Die Set (L Size)	
	2.5mm Hex. key wrench	
	Connectable parts box (6 pcs.) Ext. size:20×29×16mm	
	Carrying case (HDPE)	
(mm)		
Item No.	Case Size	Wgt.(g)
PAD-02	300×200×63mm	910g approx.

PA-11  **WIRE STRIPPER**

- Super-Light weight wire stripper
- Accurate wire stripping with single squeeze action.
- Fatigue-free owing to spring action
- Made of durable plastic



■ With strip gauge
Length of wire is adjustable using strip gauge.

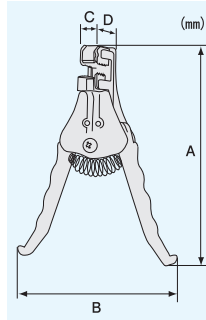

■ Size applicable

Hole diameter mm	0.5	1.2	1.6	2.0	
Stranded wire(AWG)	26	18	16	14	
Solid wire AWG	24	16	14	12	
(mm)					
Item No.	A	B	C	D	Wgt.(g)
PA-11	165	128	20	30	140

PA-30  **WIRE STRIPPER**

- One-Squeeze operation for easy stripping of applicable flat cables, 12mm width max.
- With stopper for adjustment of stripping length, 2~20mm.
- Applicable sectional area: AWG20~10

- Sliding stopper to adjust length of stripping.

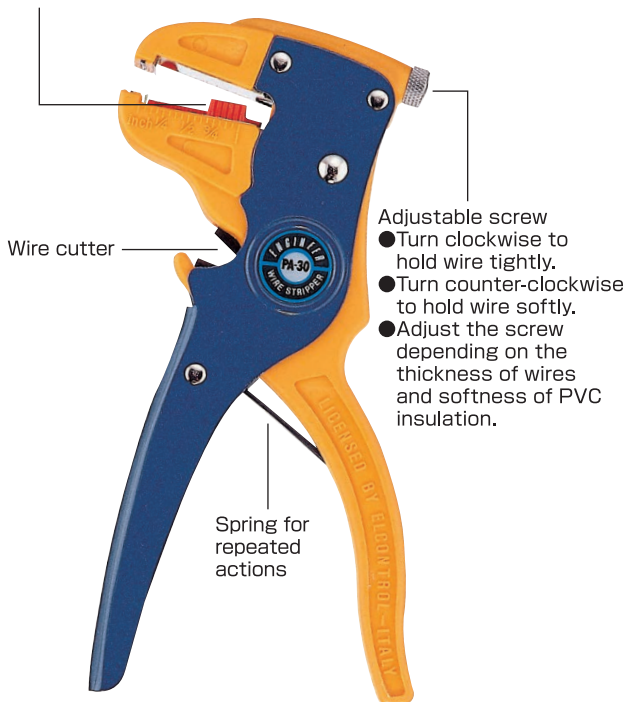



PA-91~93  **TERMINAL SET**

- Popular crimping terminals and connectors in compact plastic case.





■ PA-91 Set

Terminal	Sectional area (mm ²)	Screw diam (mm)	Contents
Bare Terminal	R 	0.5	3
		1.25	3
		1.25	4
	Y 	2	5
		5.5	6
		5.5	6







■ PA-92 Set

Terminal	Sectional area (mm ²)	Screw diam (mm)	Contents
Insulated terminal	RV 	1.25	3
		1.25	4
	YV 	2	5
		1.25	3
		1.25	4
	2	5	



■ PA-93 Set

Terminal	Sectional area (mm ²)	Screw diam (mm)	Contents
Insulated terminal	RV 	5.5	6
	YV 	5.5	6
Splice terminal	BC 	1.25	—
		2	—
Twist connector	TC 	1.25~2	—
		1.5~4	—

PAS-30~34



CONNECTOR EXTRACTOR (Spring Loaded Type)

- Perfect and simple work for extracting pin & socket contacts
- Newly designed construction with built-in return spring
- Owing to built-in spring, ejector pin retracts in the sleeve after work. It prevents the ejector pin from being damaged while carrying or not in use.

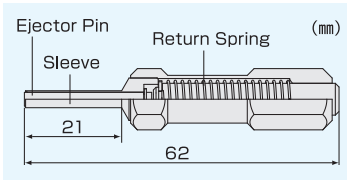

Item No.	Inner Diam of Sleeve	Outer Diam of Sleeve	Material
PAS-30	1.9	2.5	SUS303 Stainless Steel
PAS-31	2.1	2.7	
PAS-32	2.4	2.9	
PAS-33	3.1	3.6	
PAS-34	2.7	3.2	

■ Reference for extracting typical connectors

Brand/Connector	Pin Housing	Socket Housing
"TE" Mini Universal Mate-N-Lok	PAS-30	SS-30
"TE" Universal Mate-N-Lok	PAS-34	PAS-34
"TE" Commercial Mate-N-Lok	PAS-32	PAS-34
"JST" ML & EL Series	PAS-31	PAS-31
"JST" L & LL Series	PAS-33	PAS-33
"MOLEX" 1545 Series	PAS-33	PAS-34
"MOLEX" 1625 Series	PAS-30	PAS-31
"MOLEX" 3191 Series	PAS-33	PAS-33

SS-30~34



PIN EXTRACTOR

Perfect for extracting both pin and socket terminals.

- The ejector rod inside the sleeve enables you to knock out both male & female pin easily from socket terminal.

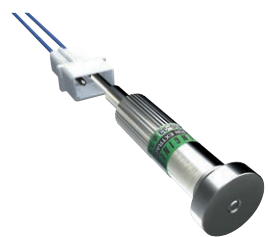

(Shape sizes)

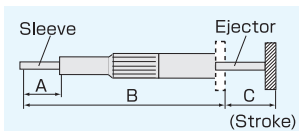

Item No.	Outer Diam of Sleeve	Inner Diam of Sleeve	A	B	C
SS-30	2.5	1.9	12	64	21
SS-31	2.7	2.1			
SS-32	2.9	2.4			
SS-33	3.6	3.1			
SS-34	3.2	2.7			

■ Reference for extracting typical connectors

Brand/Connector	Pin Housing	Socket Housing
"TYCO" Mini Universal Mate-N-Lok	SS-30	SS-30
"TYCO" Universal Mate-N-Lok	SS-34	SS-34
"TYCO" Commercial Mate-N-Lok	SS-32	SS-34
"JST" ML & EL Series	SS-31	SS-31
"JST" L & LL Series	SS-33	SS-33
"MOLEX" 1545 Series	SS-33	SS-34
"MOLEX" 1625 Series	SS-30	SS-31
"MOLEX" 3191 Series	SS-33	SS-33
"MOLEX" 8980 Series(4-pin connector in PC)	SS-32	SS-34

SCREW REMOVAL
SCISSORS
NIPPERS
PLIERS
CRIMPING STRIPPING
TWEEZERS
SCREW DRIVERS
SPECIAL DRIVERS
WRENCHES
CUTTING PROCESSING
SETS CASES
SOLDERING EQUIPMENT
ESD CHEMICALS

PH-01~04

LOCK HOLDER

- Serrated ratchet allows quick disconnect & reconnect for temporary connection.
- Ideal for assembling, soldering & precision clamping work.
- Material: Stainless Steel



Holding component

Clipping oil hose

Item No.	Length	Point shape
PH-01	125	Straight
PH-02		Curved
PH-03	150	Straight
PH-04		Curved

SS-21·22

SPRING HOOK

- Ideal for inserting, removing and adjusting coil springs of electronic components or precision instruments
- Suitable for removing connector leads, aligning leads of resistor or condenser and testing arrangements of wires
- 3mm diam.X215 O.A. length



SS-21

SS-22



SS-21



SS-22

TP-33·34

PICK-UP TOOL

- 4 spring jaws pick up small and ball bearing type parts easily and firmly.
- Suitable for assembly work of precision instruments.
- Ideal for pick-up work even in hard to reach areas.

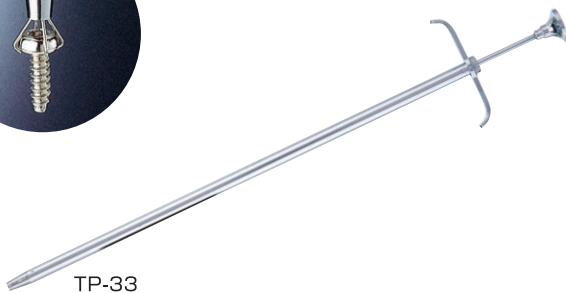

TP-33

Item No.	Housing	O.A. Length
TP-33	φ6.2	250
TP-34	φ6.2	350

TP-35·36

MAGNETIC PICK-UP TOOL

- Ideal for part retrieval in hard to reach areas
- Flexible shaft conforms to any shape
- Alnico magnet tip

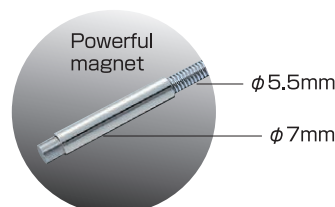

Item No.	O.A. Length
TP-35	410
TP-36	525

PA-05·06·07·14

WIRE STRIPPER

- Giving a very round finish of wires after stripping by sharp and precise edge
- Made of carbon steel alloy withstanding abrasions
- Oil-resistant Elastomer (TPR) handle



Environment-friendly Elastomer handle

PA-14 for micro-thin wire

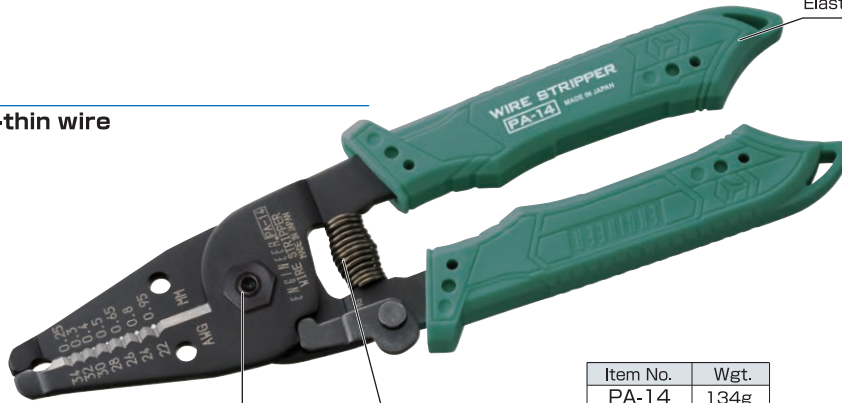
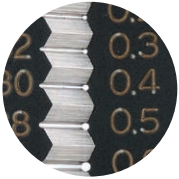

with strap hole

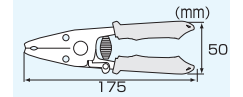

Item No.	Wgt.
PA-14	134g

Applicable Sizes Table

Stripper's Hole Diam(mm)		0.25	0.3	0.4	0.5	0.65	0.8	0.95	
Applicable wire	AWG conversion	Stranded	34	32	28~30	26	24	22~24	20~22
		Solid wire	32	30	28	26	24	22	20

() Reference

"ENGINEER" original Joint-Screw prevents the joint from being loose and offer you easy maintenance.

PA-05 for thin wire

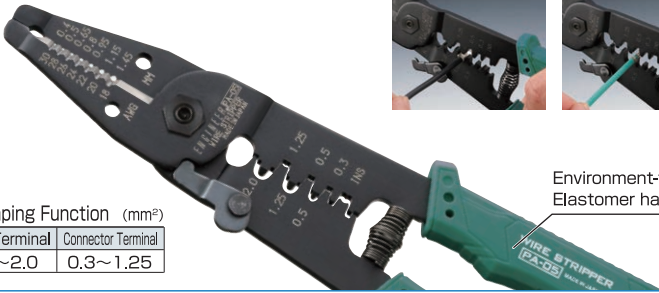

Environment-friendly Elastomer handle

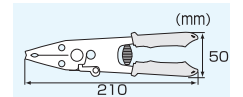

Item No.	Wgt.
PA-05	166g

Applicable Sizes Table

Stripper's Hole Diam(mm)		0.4	0.5	0.65	0.8	0.95	1.15	1.45
Applicable wire	AWG conversion	Stranded	28~30	26~28	24	22~24	20~22	20 (18)
		Solid wire	28	26	24	22	20	18

() Reference

■Crimping Function (mm²)

Bare Terminal	Connector Terminal
0.5~2.0	0.3~1.25

PA-06 for thin wire



Environment-friendly Elastomer handle

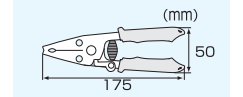

Item No.	Wgt.
PA-06	134g

Applicable Sizes Table

Stripper's Hole Diam(mm)		0.4	0.5	0.65	0.8	0.95	1.15	1.45
Applicable wire	AWG conversion	Stranded	28~30	26	24	22~24	20~22	20 (18)
		Solid wire	28	26	24	22	20	18

() Reference

PA-07 for thick wire



Environment-friendly Elastomer handle

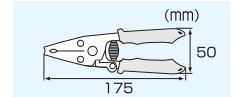

Item No.	Wgt.
PA-07	134g

Applicable Sizes Table

Stripper's Hole Diam(mm)		0.8	0.95	1.15	1.45	1.8	2.1	2.5
Applicable wire	AWG conversion	Stranded	22~24	20~22	20 (18)	(16)	14	12
		Solid wire	22	20	18	16	14	(12)

() Reference

Wire Stripper AWG Conversion (Reference only)

AWG	34	32	30	28	26	24	22	20	18	16	14	12
Stranded wire diameter(mm)	0.19	0.23	0.29	0.37	0.47	0.59	0.74	0.94	1.18	1.49	1.88	2.37
Conductor diameter(mm)	0.16	0.2	0.25	0.32	0.40	0.51	0.64	0.81	1.02	1.29	1.63	2.05
Sectional area(ml)	0.025	0.032	0.05	0.08	0.13	0.2	0.33	0.52	0.82	1.31	2.08	3.31
Stripping hole φ (mm)	PA-05		0.4	0.5	0.65	0.8	0.95	1.15	1.45			
	PA-06		0.4	0.5	0.65	0.8	0.95	1.15	1.45			
	PA-07					0.8	0.95	1.15	1.45	1.8	2.1	2.5
	PA-14	0.25	0.3	0.4	0.5	0.65	0.8	0.95				

PA-90 STRIP GAUGE

Min. stripping length 1mm!

- Saving time and giving you perfect stripping length every time
- Adjustable stripping length let you work more efficiently and reduces faults.

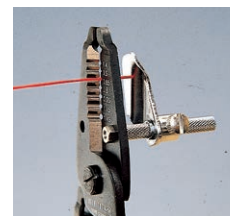

SCREW REMOVAL

SCISSORS

NIPPERS

PLIERS

CRIMPING STRIPPING

TWEEZERS

SCREW DRIVERS

SPECIAL DRIVERS

WRENCHES

CUTTING PROCESSING

SETS CASES

SOLDERING EQUIPMENT

ESD CHEMICALS

Tweezers



PT SERIES (AISI 304 Stainless Steel)

Features

- Standardized stainless steel (AISI 304), anti-magnetic, anti-acid & anti-corrosive alloy
- Hardened points are finished accurately and tensionized body to provide correct spring action & eliminate strain of fingers.
- Indicates spring action with

★ Soft ★★ Middle ★★★ Hard

PT-02 TWEEZERS (RR)

● Length : 150mm

★★



PT-04 TWEEZERS (I)

● Length : 120mm

★

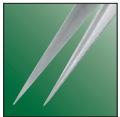

PT-06 TWEEZERS (J)

● Length : 120mm

★



PT-08 TWEEZERS

● Length : 145mm

★



PT-10 TWEEZERS

- Serrated inside point
- Length : 150mm

★★



PT-01 TWEEZERS (AA)

● Length : 125mm

★



PT-03 TWEEZERS (MM)

● Length : 125mm

★



PT-05 TWEEZERS (GG)

● Length : 120mm

★



PT-07 TWEEZERS (TS)

- Serrated inside point
- Length : 125mm

★★



PT-09 TWEEZERS

- Serrated inside point
- Length : 130mm

★★

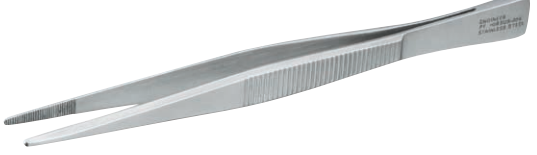

PT-11 TWEEZERS

- Serrated inside point
- Length : 230mm

★★



SCREW REMOVAL

SCISSORS

NIPPERS

PLIERS

CRIMPING STRIPPING

TWEEZERS

SCREW DRIVERS

SPECIAL DRIVERS

WRENCHES

CUTTING PROCESSING

SETS CASES

SOLDERING EQUIPMENT

ESD CHEMICALS

PT-12  **TWEEZERS (BS)**

●Length : 160mm



PT-13  **TWEEZERS**

●Length : 190mm

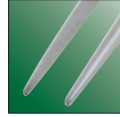

PT-14  **REVERSE ACTION TWEEZERS**

- Handles are squeezed to open points.
- Serrated inside points
- Length : 175mm

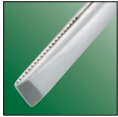

PT-15  **TWEEZERS**

- Inside polished points for picking up small sheets.
- Length : 105mm



SOLID ARM TWEEZERS SERIES

- Features
- 2.2mm thickly-designed arms hold IC chip more steadily than conventional tweezers.
 - Stiff arms can not bend easily and hold a small component very steadily.
 - AISI 304 anti-magnetic stainless steel

Arm Thickness:
1.5 times!!

PT-16

Conventional
tweezers



PT-16·17·31

 **SOLID ARM TWEEZERS**

- 0.5mm Fine tip
- Length:125mm



PT-16

- 1.3mm Squared tip
- Length:125mm

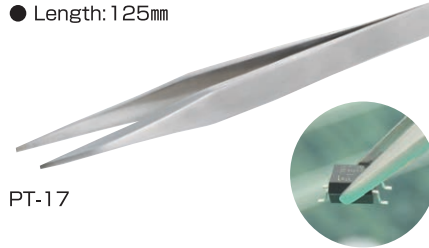

PT-17

- 0.3mm Fine tip (GG)
- Length:120mm

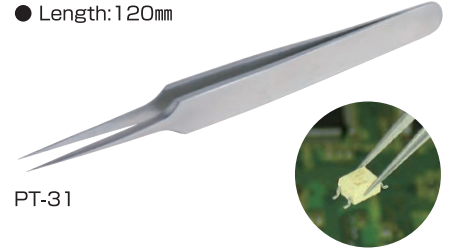

PT-31

TITANIUM TWEEZERS SERIES (100% ANTI-MAGNETIC)

- Features
- Perfect anti-magnetic titanium, safety in work of electronics and computer device. No solder residue left.
 - No corrosion, No rusting and Anti-ionization, ideal for chemical & biological fields

- Light weight, 40% less than ordinary stainless steel tweezers, for fatigue-free work

★ Soft ★★ Middle ★★★ Hard

PTN-01 TYPE AA  **TITANIUM TWEEZERS**

- Length : 125mm
- with soft case



General use tweezers with strong sharply pointed type.

with Soft Case **PTK-90**

PTN-02 TYPE GG  **TITANIUM TWEEZERS**

- Length : 120mm
- with soft case



Needle-like, very thin tips for handling microscopic parts.

with Soft Case **PTK-90**

PTN-03 TYPE J  **TITANIUM TWEEZERS**

- Length : 120mm
- with soft case



very thin and curved tips for working on microminiature assemblies.



with Soft Case **PTK-90**

ENGINEERING PLASTIC, PPS (Polyphenylenesulfide) TIP

Features

- ESD-Safe tip ideal for handling static sensitive components
- Holding the object softly without any possibility of damage like metal tweezers
- Totally anti-magnetic body including stainless steel shank
- Anti-acid chemical resistance
- High wear-resistant and replaceable tip
- Heat resistance up to 270°C (ASTM D648)
- ※ The above is Deflection temperature and is not to guarantee performance of tip against heated object.

STATIC SAFE MILD CONTACT

SOFT SPRING ACTION

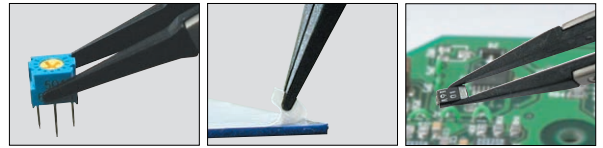

PTZ-41·42·43

ESD PLASTIC-TIPPED TWEEZERS



PTZ-41

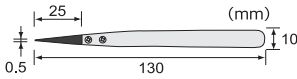

▲ Fine Tip PTZ-41

PTZ-42

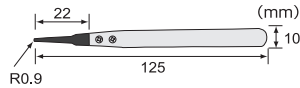

▲ Duckbill Tip PTZ-42

PTZ-43

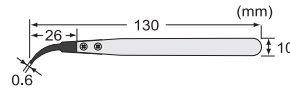

▲ Curved Nose (J) PTZ-43

■ PPS-TIPPED STAINLESS TWEEZERS

Item No.	Overall Length	Tip	Shank Width	Wgt.
PTZ-41	130mm	0.5mm Fine Tip	10mm	16g
PTZ-42	125mm	R0.9mm Duckbill	10mm	16g
PTZ-43	130mm	0.6mm Fine Tip	10mm	16g

PTZ-91

SPARE TIP FOR PTZ-41



Fine tip

■ Contents : tip 2 pcs. & screw 4 pcs./set

Item No.	Material	Surface Resistivity
PTZ-91	PPS	$1 \times 10^5 \sim 10^7 \Omega$

PTZ-92

SPARE TIP FOR PTZ-42



Duckbill tip

■ Contents : tip 2 pcs. & screw 4 pcs./set

Item No.	Material	Surface Resistivity
PTZ-92	PPS	$1 \times 10^5 \sim 10^7 \Omega$

PTZ-93

SPARE TIP FOR PTZ-43



■ Contents : tip 2 pcs. & screw 4 pcs./set

Item No.	Material	Surface Resistivity
PTZ-93	PPS	$1 \times 10^5 \sim 10^7 \Omega$

PTZ-45·46

ESD PLASTIC TIPPED TWEEZERS

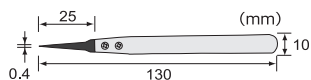

▲ Fine Tip PTZ-45

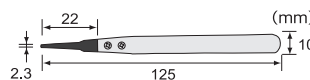

▲ Squared Tip PTZ-46

■ PPS-TIPPED STAINLESS TWEEZERS

Item No.	Overall Length	Tip	Shank Width	Wgt.
PTZ-45	130mm	0.4mm Fine tip	10mm	16g
PTZ-46	125mm	2.3mm Squared	10mm	16g

PTZ-95

SPARE TIP FOR PTZ-45



Fine tip

■ Contents : tip 2 pcs. & screw 4 pcs./set

Item No.	Material	Surface Resistivity
PTZ-95	PPS	$1 \times 10^5 \sim 10^7 \Omega$

PTZ-96

SPARE TIP FOR PTZ-46



Squared tip

■ Contents : tip 2 pcs. & screw 4 pcs./set

Item No.	Material	Surface Resistivity
PTZ-96	PPS	$1 \times 10^5 \sim 10^7 \Omega$

SCREW REMOVAL

SCISSORS

NIPPERS

PLIERS

CRIMPING STRIPPING

TWEEZERS

SCREW DRIVERS

SPECIAL DRIVERS

WRENCHES

CUTTING PROCESSING

SETS CASES

SOLDERING EQUIPMENT

ESD CHEMICALS

PTZ-61~63

BLACK-COATED ESD TWEEZERS

Static dissipative black-coated tweezers

- ESD-safe body ideal for handling static sensitive components ($1 \times 10^5 \sim 10^9 \Omega$)
- Anti-magnetic and non-corrosive stainless steel body
- Non-slip and anti-glare rugged surface for easy handling

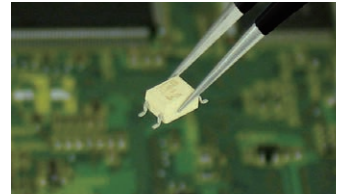

PTZ-61

▲ Fine tip PTZ-61

PTZ-62

▲ Duckbill tip PTZ-62

PTZ-63

▲ Type GG PTZ-63

Item No.	Overall Length	Tip Length	Shank Width
PTZ-61	125	60	11
PTZ-62	120	35	10
PTZ-63	113	34	10

PTZ-51

CERAMIC-TIPPED TWEEZERS

High-temperature resistant ceramic tip featuring less solder adhesive

- Heat resistance : 1,000 °C (Tip)
- High wear-resistant and anti-acid tip
- Excellent electrical insulation
- Material : Anti-Magnetic stainless steel body with zirconia ceramic fine tip

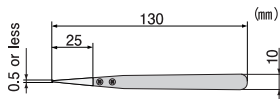

PTZ-94

SPARE TIP FOR PTZ-51



■ Contents : tip 2 pcs. & screw 4 pcs./set

PTS SERIES

Features ● Anti-corrosive stainless steel

PTS-01

TWEEZERS

- Straight AA type
- Length:125mm



PTS-03

TWEEZERS

- Curved with serrated inside
- Length:125mm



PTS-02·04~08

TWEEZERS

- Straight with serrated inside



Item No.	Length(mm)
PTS-02	125
PTS-04	150
PTS-05	180
PTS-06	210
PTS-07	240
PTS-08	300

Screwdrivers



DG-01~04 PRO GRIP DRIVER

- Soft grip handle provides excellent tightening power without slipping.
- Chrome-vanadium alloy steel, perfectly heat-treated gives it lasting durability.
- Black magnetic oxide tip.
- Chrome plated.



(mm)

Item No.	Point Size	Shaft Length	Shaft diam.	Handle diam.	O.A. Length
DG-01	⊖5.5×0.7	80	5.5	28	200
DG-02	⊕#1	80	5.5	28	200
DG-03	⊖6.3×0.9	76	6.3	32	214
DG-04	⊕#2	76	6.3	32	214

DG-05 CUSHION DRIVER

- ⊕/⊖ Two-in-one reversible blade.
- Comfortable soft-grip handle.
- Can also be used with electric and air drivers.



(mm)

Item No.	Point Size	Shaft Length	Shaft diam.	Handle diam.	O.A. Length
DG-05	⊕#2/⊖6	95	6.3	34	210

DP-03~64 PRO-USE DRIVER

- Chrome Vanadium alloy steel & complete heat treated blade.
- Black oxide finish blade.
- Knurl shaft for quick rotation



Size table (mm)

Item No.	Blade size	Shaft length	Shaft diam.	Handle diam.	O.A. Length
DP-03	#00	75	3	15	146
DP-24	#0	100	4.3	18	183
DP-44	#1	100	5.5	25	200
DP-64	#2	100	6.3	27	213
DP-13	⊖3.0×0.35	75	3	15	146
DP-34	⊖4.3×0.5	100	4.3	18	183
DP-54	⊖5.5×0.7	100	5.5	25	200

(Blade size=width×thickness)

DG-08·09 MASTER GRIP DRIVER

- Master Cushion grip assures powerful fastening power.
- Bottom marking & color distinguish phillips from slotted tip.
- Special alloy steel blade, tempered & plated for lasting durability.
- Precision black-point finish, magnetic point.



(mm)

Item No.	Point Size	Shaft Length	Shaft diam.	Handle diam.	O.A. Length
DG-08	⊕#2	70	6.3	40	195
DG-09	⊖6×1.0	70	6.3	40	195

DG-11~14 EXTRA LONG GRIP DRIVER

- Cushion grip handle which fits perfect in the hand provides excellent tightening power.
- Shafts are made of chrome vanadium alloy steel, entirely heat treated with black magnetic oxide tip.
- Chrome plated finish.



(mm)

Item No.	Point Size	Shaft Length	Shaft diam.	Handle diam.	O.A. Length
DG-11	⊖6.0×0.8	225	6.3	32	362
DG-12	⊕#2	225	6.3	32	362
DG-13	⊖6.0×0.8	275	6.3	32	412
DG-14	⊕#2	275	6.3	32	412

DS-03~64 STANDARD DRIVER



Size table for ⊕ driver (mm)

Item No.	⊕Blade size	Shaft length	Shaft diam.	Handle diam.	O.A. Length
DS-03	#00	75	3	11	128
DS-23	#0	75	4.3	16	151
DS-24	#0	100	4.3	16	176
DS-44	#1	100	5.5	18	185
DS-46	#1	150	5.5	18	235
DS-64	#2	100	6.3	22	193

Size table for ⊖ driver (mm)

Item No.	⊖Blade size	Shaft length	Shaft diam.	Handle diam.	O.A. Length
DS-12	2.6×0.35	50	3	11	103
DS-13	2.6×0.35	75	3	11	129
DS-14	2.6×0.35	100	3	11	154
DS-33	4.0×0.5	75	4.3	16	150
DS-34	4.0×0.5	100	4.3	16	175
DS-54	5.5×0.7	100	5.5	18	184

DG-21~24  **MINI SOFT DRIVER**

- Comfortable soft-grip handle.
- Chrome-vanadium steel & perfectly heat-treated blade.
- Black oxide point.
- Chrome plated finish.



Item No.	Blade size	Shaft length	Shaft diam.	Handle diam.	O.A. Length
DG-21	⊖3×0.4	80	3	21	167
DG-22	⊕#00	80	3	21	167
DG-23	⊖4×0.5	80	4	21	167
DG-24	⊕#0	80	4	21	167

DK-16  **MINI SOFT DRIVER SET**

- Contents
- DG-21
 - DG-22
 - DG-23
 - DG-24

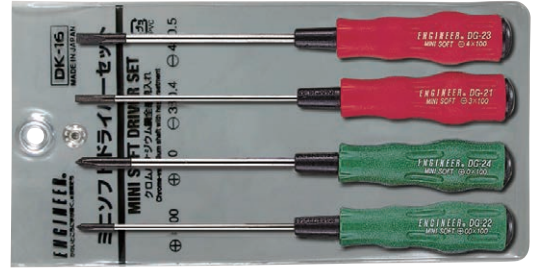

DST-01·02  **STUBBY DRIVER**



Item No.	Tip size	Shaft length	Shaft diam.	Handle diam.	O.A. Length
DST-01	⊖6.3×0.9	38	6.3	30	86
DST-02	⊕ #2	38	6.3	30	86

DST-05  **COMBINATION REVERSIBLE STUBBY DRIVER**

- 2-in-1 ⊕/⊖ reversible in single hand.
- Extra compact 85mm O.A. length.

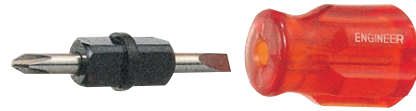

Item No.	Tip size	Blade length	Blade diam.	Handle diam.	O.A. Length
DST-05	⊕#2/⊖6.3	23	6.3	30	85

DST-06·07  **MINIATURE REVERSIBLE DRIVER**

- 2-in-1 ⊕/⊖ reversible in single hand.
- Specially compact design in 42mm O.A. length.

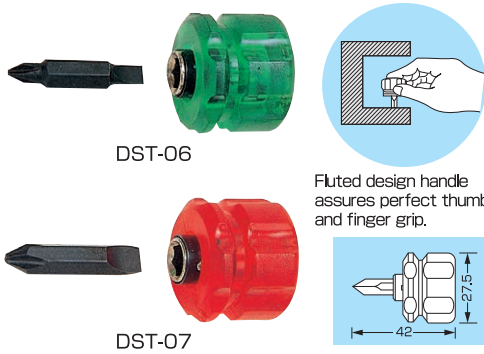

Item No.	Tip size	Bit length	Bit diam.	Handle diam.
DST-06	⊕#1/⊖4.5	16	6.3	27.5
DST-07	⊕#2/⊖6	16	6.3	27.5

DK-50  **REVERSIBLE DRIVER SET**

- ⊕/⊖ Reversible type, 3pcs. set
- Contents: DK-51 ⊕#00/⊖2.6
DK-52 ⊕#1/⊖4.5
DK-53 ⊕#2/⊖6



DK-51~53  **REVERSIBLE DRIVER**

- ⊕/⊖ Two-in-one



Item No.	Tip size	Blade length	Blade diam.	Handle diam.	O.A. Length
DK-51	⊕#00/⊖2.6	67	3	18	164
DK-52	⊕#1/⊖4.5	82	5	24	195
DK-53	⊕#2/⊖6	89	6.3	26	216

DR-54  **STUBBY RATCHET DRIVER**

- Super compact stubby driver for hard-to-reach areas
- Improved efficiency due to the ratchet mechanism
- Magnet bit socket to attract and hold the bit firmly and securely in place



Item No.	Bit size	Gear positions	Swing arc	Material	Wgt.
DR-54	⊕#2×25mm	45	8 degrees	Handle: Aluminium Bit: Carbon steel	50g

DZ-01·02  **MINIATURE DRIVER**

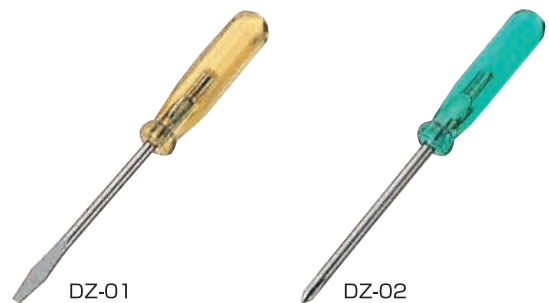

Item No.	Point Size	Shaft Length	Shaft diam.	Grip diam.	O.A. Length
DZ-01	⊖1.6×0.3	30	2	6.3	55
DZ-02	⊕ #000	30	2	6.3	55

SCREW REMOVAL

SCISSORS

NIPPERS

PLIERS

CRIMPING STRIPPING

TWEEZERS

SCREW DRIVERS

SPECIAL DRIVERS

WRENCHES

CUTTING PROCESSING

SETS CASES

SOLDERING EQUIPMENT

ESD CHEMICALS

DR-52  **MASTER GRIP DRIVER**

Provides the most useful and popular magnetic bits.

- Tips also fit most rechargeable and electric drivers.
- Chrome-vanadium steel.
- Cushion grip handle.

Bullet-type bit holder for portable use.

Cushion grip



Bit set is separately available **DR-16**



Easy slide-in

DR-07  **TWIN WRENCH DRIVER SET**

Designed for sure-gripped work in restricted areas.

- 10-in-1 combination of the most useful \oplus/\ominus tips.
- Knurled cushion handle fits the hand and the job.
- With portable bullet holder.
- Replacement bit sizes \oplus #00, #1, #2 \ominus 4.5, 6
- 1.5, 2, 2.5, 3, 4



DR-03  **RATCHET STUBBY DRIVER**

- Compact 95mm O.A. length with a comfortable grip.
- Built-in ratchet mechanism.
- Replacement bits: \oplus #2/ \ominus 6mm, \oplus #1/ \ominus 4.5mm.
- Knurl shaft for quick rotation

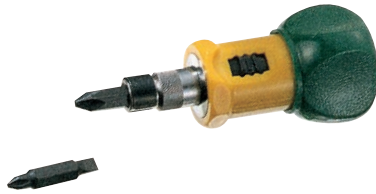

DR-04  **RATCHET STUBBY DRIVER SET**

- Versatile driver with common replaceable \oplus/\ominus point bits.
- Built-in ratchet mechanism.
- Replacement set includes : \oplus #00, #1, #2, \ominus 4.5, 6
- 2.5, 3, 4, 5, 6
- Knurl shaft for quick rotation



DR-08  **RATCHET STUBBY DRIVER SET WITH FLEXIBLE SHAFT**

Versatile flexible shaft makes difficult jobs easy

- 6-in-1 ratchet stubby type comes with most needed \oplus/\ominus , hex, box bits and flexible shaft.
- Easy access to tighten screws & nuts at hard-to-reach positions.
- Knurl shaft for quick rotation

Flexible shaft is designed to bend max. 75 degree in double construction. The piano wire is covered with flexible insulation.

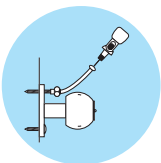

For use at hard-to-reach positions.



Flexible shaft is workable with rechargeable driver.

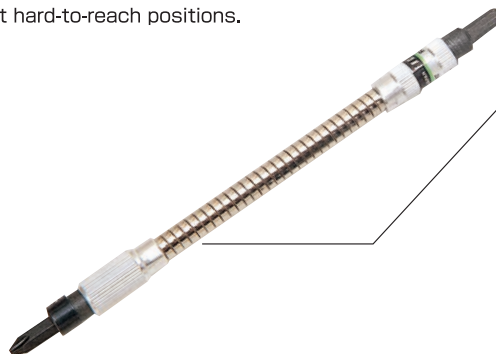

Bullet holder is clipped to belt or tool panel.

CONTENTS

- Ratchet stubby O.A.length:80mm
- Flexible shaft O.A.length:182mm
- \oplus/\ominus bit \oplus #2/ \ominus 6, \oplus #1/ \ominus 4.5
- Hex bit ● 2, 2.5, 3mm
- Box bit ○ 5.5mm

DR-05  **OFFSET RATCHET DRIVER**

- Built-in quick ratchet mechanism increases work productivity.
- Designed to permit work in close areas that are inaccessible with ordinary drivers.
- Tip : \oplus #2/ \ominus 6mm

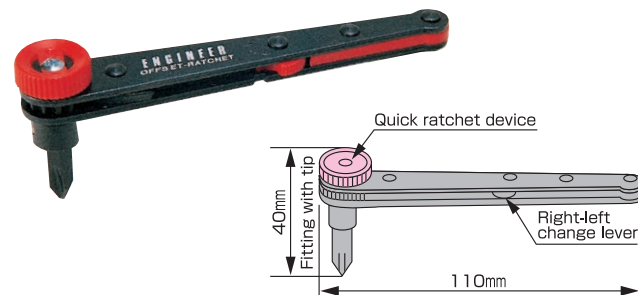

DR-06  **OFFSET RATCHET DRIVER WITH BIT SET**

Excellent for working in close areas!

- Versatile driver with most popular \oplus/\ominus & hex bits.
- Complete with handy bullet holder for carrying.
- Replacement set includes: \oplus #00, #1, #2, \ominus 4.5, 6
- 1.5, 2, 2.5, 3, 4
- Built-in quick ratchet device.

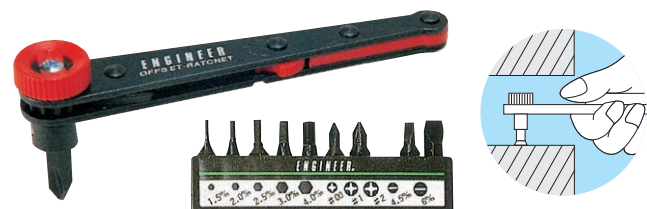

DR-55

RoHS MINI OFFSET RATCHET

Only 22mm-high low-profile head accessible to tight space !!

- Built-in quick ratchet device increases work productivity.
- Bit set includes : ⊕#1, #2, #3 & ⊖6mm

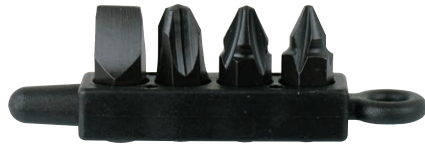
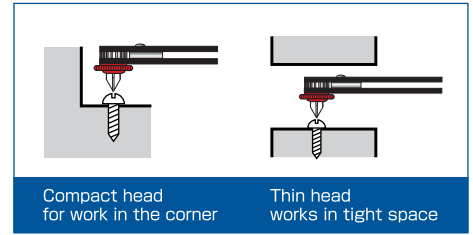

Super-thin Head 22mm

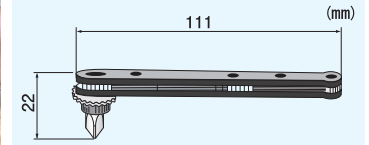

DR-56

RoHS 7-in-1 ANGLED RATCHET

- Ratchet handle with angled heads for ease of operation (Max. torque: 27.4 Nm)
- Use as a screwdriver (adaptor included) with a selection of 5 low-profile bits in a bullet holder.
- Bit adaptor accepts standard 6.35mm (1/4") hex bits.
- Low-profile head accessible to tight spaces
- ※ No socket is included in this product.

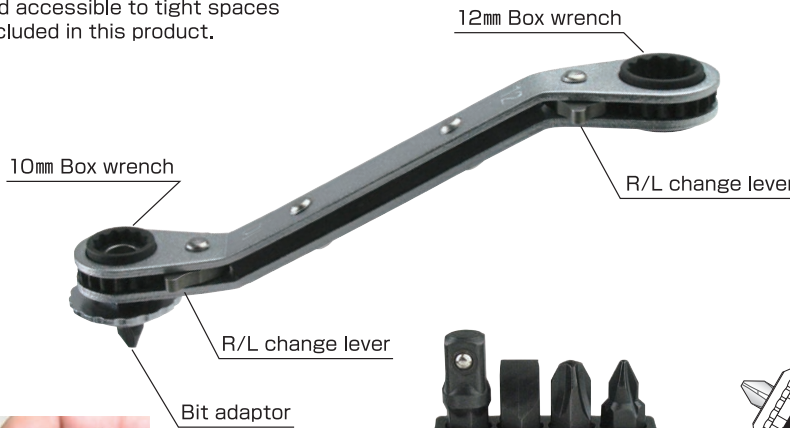

Slim Head 24.5mm

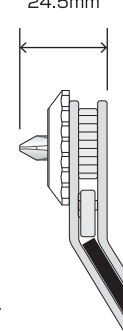

Item No.	Bit Sizes	Length (mm)	Wgt.(g)
DR-56	⊕#1, #2, #3, ⊖6 1/4" socket adapter	135	78

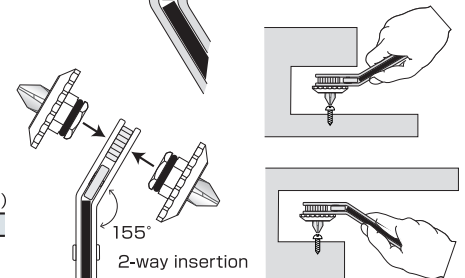

DR-10·11·15~17

RoHS BIT SET

- A comprehensive and wide selection of bits to handle any job or application.
- Bullet type bit holder suitable for portable use
- DR-16 bits are also used for rechargeable or electric drivers.

DR-10

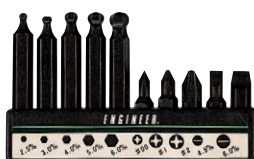

DR-11



DR-17

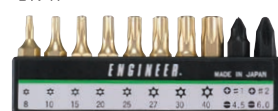

DR-15



DR-16



Item No.	Number of bits	Bit Sizes	Length (mm)	Wgt.(g)
DR-10	10	⊕#00, #1, #2, ⊖4.5, 6, ●2.5, 3, 4, 5, 6 (Ball bit)		97
DR-11	10	⊕#00, #1, #2, ⊖4.5, 6, ●1.5, 2, 2.5, 3, 4 (Hex bit)	30	67
DR-15	6	★/★ T5/T6, ★/★ T7/T8, ★/★ T9/T10, T15/T20, T25/T27, T30/T40	110	159
DR-16	6	⊕ Double end bit...#2×65 #2×110 ⊕ Step type...#0×85 #1×100 #2×150 ⊕ bit...#2/⊖6×135		147
DR-17	10	★...T8, T10, T15, T20, T25, T27, T30, T40 ⊕ Double end bit...#1/⊖4.5, #2/⊖6 (⊕ bits are magnetic)	30	68

SCREW REMOVAL

SCISSORS

NIPPERS

PLIERS

CRIMPING STRIPPING

TWEEZERS

SCREW DRIVERS

SPECIAL DRIVERS

WRENCHES

CUTTING PROCESSING

SETS CASES

SOLDERING EQUIPMENT

ESD CHEMICALS

Special Drivers



DT/DTC/DTP/DTY SERIES



MOBILE PHONE DRIVER

Made for special screws, ideal for maintenance work of cordless phones, cellular phones, etc.



Torx (Hex-lobe) screws

There may be a projection in the center of screw hole for prevention of theft and tampering. Torx (Hex-lobe) screws are used for cordless phone, transceiver, precision instruments, etc.

DTC-27



Point size

(mm)

Item No.	Point size	Shaft Length	Shaft diam.	Handle diam.	O.A. Length	Main Use	
DTC-20	3.6	90	4.5	7.0	25	190	Game console/Soft
DTC-27	4.6	90	5.9	7.0	25	190	Game console

DAP-01



DTP-05



Point size

(mm)

Item No.	Point size	Shaft Length	Shaft diam.	Handle diam.	O.A. Length	Main Use
DAP-01	0.9	23	3.0	10	113	Smart phone
DTP-03	1.3	75	3.0	15	146	Mobile phone, etc
DTP-05	1.7	100	5.5	25	200	Mobile phone, etc



Applicable to tampering-proof screws (T6~T20)

(mm)

Item No.	Point size	Shaft length	Shaft diam.	Handle diam.	O.A. Length	Main Use
DT-02	★0.9 T2	75	3.0	15	146	Game console
DTX-04	★1.2 TX4	75	3.0	15	146	Smart phone/Mobile phone
DT-04	★1.3 T4	75	3.0	15	146	Smart phone/Mobile phone
DT-05	★1.4 T5	75	3.0	15	146	
DT-06	★1.7 T6	75	3.0	15	146	
DTX-08	★2.0 TX8	75	3.0	15	146	Smart phone/Mobile phone
DT-08	★2.3 T8	75	3.0	15	146	
DT-10	★2.7 T10	100	5.5	25	200	
DT-15	★3.3 T15	100	5.5	25	200	
DT-20	★3.8 T20	100	5.5	25	200	

DAT-02



Point size

(mm)

Item No.	Point size	Shaft Length	Shaft diam.	Handle diam.	O.A. Length	Main Use
DAT-02	★0.9 T2	23	3.0	10	113	Game console

DTY-03



Point size

(mm)

Item No.	Point size	Shaft Length	Shaft diam.	Handle diam.	O.A. Length	Main Use
DTY-02	1.7	75	3.0	15	146	Game/Mobile phone
DTY-03	2.4	75	3.0	15	146	Game/Mobile phone

DR-18



BIT SET FOR MOBILE PHONE

10-in-1 special driver bit set

- Easy to distinguish different color band.
- Magnet point attracting a tiny screw.

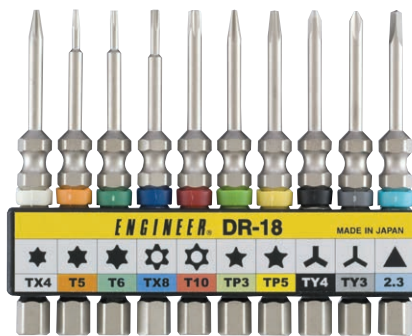

DR-50



TWIN WRENCH DRIVER (For Special Screws)

Ideal for sure-gripped work in restricted areas.

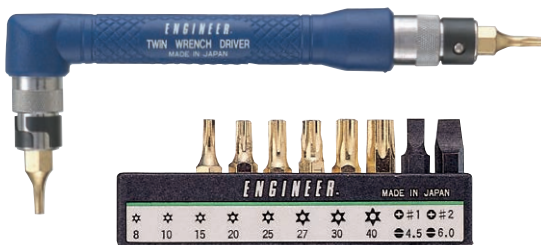

- Off-set twin wrench driver with 8 Torx bits and 2 ⊕/⊖ bits.
- Non-slip knurled cushion handle.
- Bullet type replaceable bit holder.

CONTENTS

(mm)

Shape of Bit	Point	Size
Torx bit	★	8 10 15 20 25 27 30 40
⊕/⊖ bit	+ -	⊕#1/⊖4.5 ⊕#2/⊖6.0

Bit set is separately available [DR-17](#)

SCREW REMOVAL

SCISSORS

NIPPERS

PLIERS

CRIMPING STRIPPING

TWEEZERS

SCREW DRIVERS

SPECIAL DRIVERS

WRENCHES

CUTTING PROCESSING

SETS CASES

SOLDERING EQUIPMENT

ESD CHEMICALS

DR-51

MASTER GRIP DRIVER (For Hex-Lobe Screws)

Accommodates 12 different sized Torx (hex-lobe) screws.

- 6 double ended hex-lobe bits fit 12 different screw sizes from T-5 to T-40.
- Bits are made of chrome-vanadium steel.
- Cushion grip handle.

Cushion grip

Easy slide-in

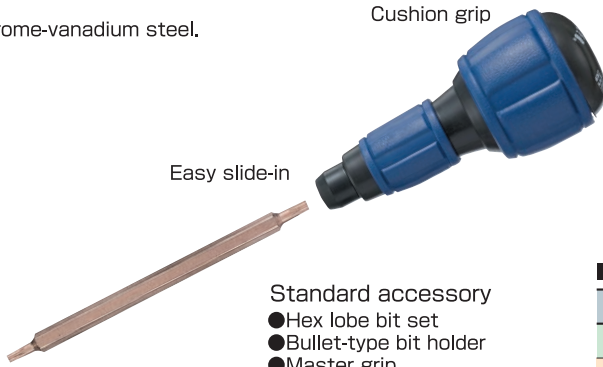

Standard accessory

- Hex lobe bit set
- Bullet-type bit holder
- Master grip

Bit set is separately available **DR-15**



■ Contents of bit set (12 sizes)

Tip Shape	Tip Size	O.A.Length
☆ / ☆	T-5 / T-6	110mm
☆ / ☆	T-7 / T-8	
☆ / ☆	T-9 / T-10	
☆ / ☆	T-15 / T-20	
☆ / ☆	T-25 / T-27	
☆ / ☆	T-30 / T-40	

■ Applications for hex-lobe screws (mm)

Size	T5	T6	T7	T8	T9	T10	T15	T20	T25	T27	T30	T40
Outer diam.	1.4	1.7	2.0	2.3	2.5	2.7	3.3	3.8	4.4	5.0	5.5	6.6
Screw adapted	-	M2	-	M2.5	-	M3	M3.5	M4	M5	M5	M6	M8

※ Diameter is just for reference

DJ-03·04

PLUG JACK DRIVER

- Ideal for use with radio microphone jacks.



DJ-03
C type

DJ-04
C type



C type

Item No.	Tip shape & size			Shaft length	Shaft diam.	Handle diam.	O.A. Length
	A	B	C				
DJ-03	-	-	4	75	4.3	16	150
DJ-04	-	-	6	75	4.3	16	150

(mm)

DN-01~12

NUT DRIVER

- Anti-abrasive point of special steel.
- Nickel-plated finish.

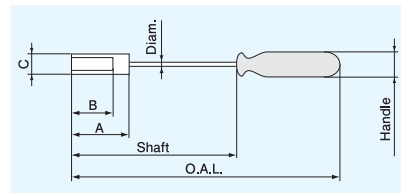
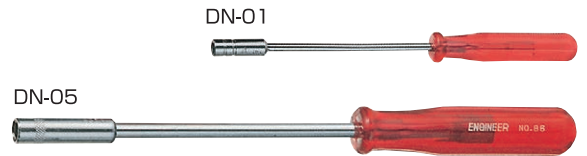

Item No.	Size	A	B	C	Shaft Length	Shaft diam.	Handle diam.	O.A. Length	Screw adapted
DN-01	3	18	9	6	75	3.0	11	130	(1.4)
DN-02	4	18	9	6	75	3.0	11	130	2
DN-03	4.5	18	9	8	75	4.0	13	145	(2.3)
DN-04	5	35	25	7.5	75	4.3	16	150	(2.6)
DN-05	5.5	35	25	9	125	5.5	18	210	3
DN-06	6	35	25	9	125	5.5	18	210	(3)
DN-07	7	35	25	11	125	5.5	18	210	4
DN-08	8	35	25	12	125	5.5	18	210	5
DN-09	9	35	25	13	125	5.5	18	210	(5)
DN-10	10	35	25	14	125	6.3	22	220	6
DN-12	12	36	25	17	125	6.3	22	220	(6)

(mm)

() = old specifications

DNC-55T·57T·65T

NUT CATCHING DRIVER

Magnet hold type for easy operation

- Solid shaft machined from one piece of metal, for improved durability.
- Suitable for maintenance service of facsimile machine and photocopying machine.
- Sliding magnet in socket attracts and catches a hex bolt while fitting different heights of the heads.
- Material: Cr-V (shaft), Cellulose Acetate (handle)

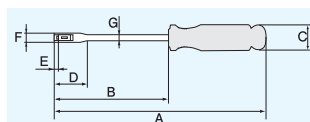
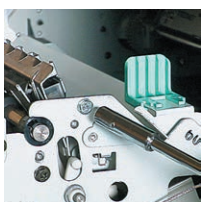
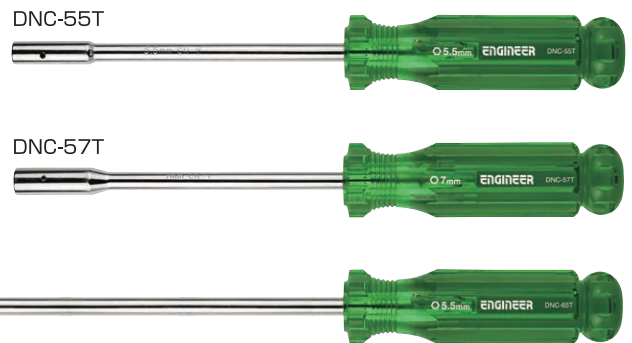

Item No.	Size	A	B	C	D	E	F	G	Wgt.
DNC-55T	5.5	233	127	29	32	0.5~3.0	9	7	120g
DNC-57T	7	233	127	29	37	0.5~4.3	11	7	125g
DNC-65T	5.5	336	230	29	32	0.5~3.0	9	7	153g

(mm)

DK-13

REVERSIBLE PRECISION DRIVER SET

- Driver's shaft length to be adjustable 18~90mm.
- Magnetic point ⊕ for hard-to-reach screws.
- ● 4mm slim shaft with double-ended blade (5-in-1)
- Cushioned grip for well-fitting with fingers.
- With rotary cap for quick rotation or precise alignment work

Contents 3 pcs. (Double-ended)	
Length: 125mm	
# 00	⊕ 2.5mm
# 0	⊕ 3.0mm
# 0	⊕ 4.0mm

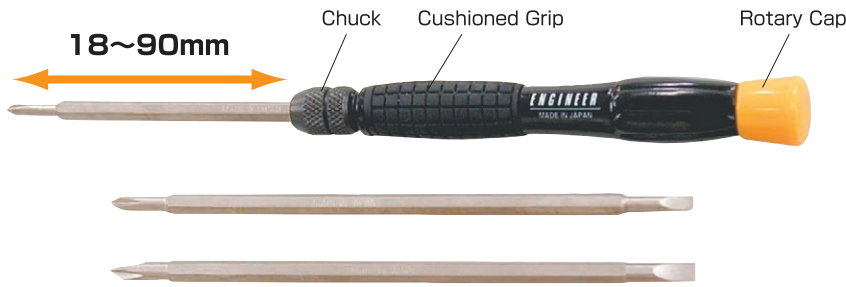

DKD-01

CIRCUIT TESTING DRIVER

- AC80~250V, DC100~300V
- For continuity & transmitting test
- O.A. Length: 129mm

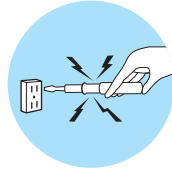

DKD-03

LED CIRCUIT TESTER

- AC100-250V (Low voltage use)
- High brightness LED built-in
- Continuity check of circuit
- Polarity check of electric outlet
- Blade (3.0 x 0.4mm) with protective cap
- O.A. Length : 120mm

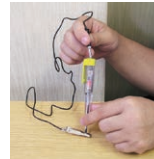

Continuity check



DB-15~40

BALL POINT DRIVER

- Ball head will work from an angle up to 30° off axis.
- Heat-treated alloy steel with electroless nickel plating
- Magnetized point



Ball Ended Point.

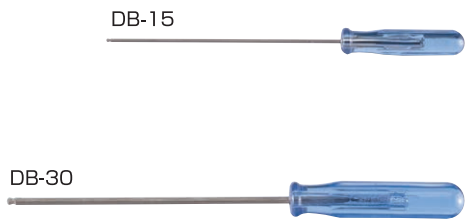

(mm)					
Item No.	Size ●↕	Shaft length	Shaft diam.	Handle diam.	O.A. Length
DB-15	1.5	70	1.5	11	124
DB-20	2	70	2	11	124
DB-25	2.5	70	2.5	16	143
DB-30	3	100	3	16	173
DB-40	4	120	4	18	204

DH-15~50

HEX DRIVER

- Heat-treated, chrome-molybdenum alloy steel blade.



(mm)				
Item No.	Size ●↕	Shaft length	Handle diam.	O.A. Length
DH-15	1.5	90	11	144
DH-20	2	90	11	144
DH-25	2.5	90	11	144
DH-30	3	90	16	163
DH-40	4	90	16	163
DH-50	5	90	18	175

SCREW REMOVAL

SCISSORS

NIPPERS

PLIERS

CRIMPING STRIPPING

TWEEZERS

SCREW DRIVERS

SPECIAL DRIVERS

WRENCHES

CUTTING PROCESSING

SETS CASES

SOLDERING EQUIPMENT

ESD CHEMICALS

DK-14

RoHS NUT DRIVER SET

- Set of 6 nut drivers with across flats 3~6mm
- Magnetized sockets



Slim socket design

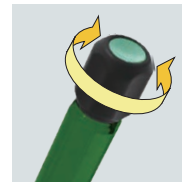

With rotary cap



Self-standing holder

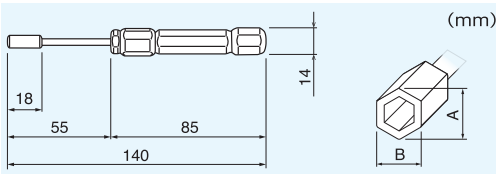

Materials	
Socket:Cr-Mo	
Shaft:Cr-V	
Handle:Cellulose Acetate	
Cap:PP	

Item No.	Across Flats	Screw Diameter	Ext. Socket Size		Wgt.
			A	B	
DK-14	3	M1.4/M1.5	6.3	5.6	155g (Holder included)
	4	M2	6.3	5.6	
	4.5	M2.3	8	7	
	5	M2.5/M2.6	8	7	
	5.5	M3	9.1	8	
	6	M3.5	9.1	8	

DK-01・02

RoHS HEX DRIVER SET

- Set of 4 (DK-01) and 6 (DK-02) most popular hex drivers in a vinyl pouch.



- DK-01 (4pcs)**
- DH-15
 - DH-20
 - DH-25
 - DH-30



- DK-02 (6pcs)**
- DH-15
 - DH-20
 - DH-25
 - DH-30
 - DH-40
 - DH-50

Screw adapted (mm)		
Size	Cap screw	Set screw
1.5	M1.6,M2	M3
2.0	M2.5,M2.6	M4
2.5	M3	M5
3.0	M4	M6
4.0	M5	M8
5.0	M6	M10

DK-03 BALL DRIVER SET

- Set of 5 most popular ball drivers in a vinyl pouch.



- DK-03(5pcs)**
- DB-15
 - DB-20
 - DB-25
 - DB-30
 - DB-40



DK-04

RoHS NUT DRIVER SET

7-in-1 assortment of Compact-sized Nut Drivers
 Contents:ø3, 3.5, 4, 4.5, 5, 5.5, 6mm

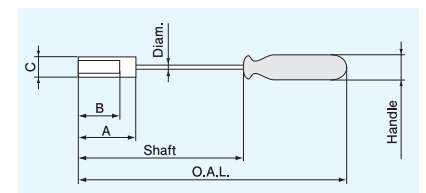

(mm)								
Size	A	B	C	Shaft length	Shaft diam.	Handle diam.	O.A. Length	
3	18	9	6	75	3.0	11	130	
3.5			6					
4			6					
4.5			8		4.0			13
5			8					
5.5			9					
6	9							

DM-20  **PRECISION DRIVER SET**

DM-30  **PRECISION DRIVER SET**

DM-60  **PRECISION DRIVER SET**



Item No.	Tip Size	Blade Diam.	O.A. Length
DM-21	#0000	1.4	76
DM-22	#000	1.6	84
DM-23	#00	2	90
DM-24	#0	2.4	102
DM-25	#1	3	110
DM-26	#1	3	118

Item No.	Tip Size	Blade Diam.	O.A. Length
DM-31	1.0×0.2	1	73
DM-32	1.2×0.3	1.2	79
DM-33	1.8×0.3	1.8	89
DM-34	2.4×0.45	2.4	102
DM-35	3.0×0.6	3	110
DM-36	3.5×0.7	3.5	118

Item No.	Tip Size	Blade Diam.	O.A. Length
DM-22	#000	1.6	84
DM-24	#0	2.4	102
DM-25	#1	3	110
DM-33	1.8×0.3	1.8	89
DM-34	2.4×0.45	2.4	102
DM-35	3.0×0.6	3	110

DK-05  **INTERCHANGEABLE DRIVER SET**

With circuit testing driver handle for low voltage.
(AC80~250V/DC100~300V)
Contents: ⊖5.5mm, ⊕#00, #0, #1, #2, #3

DK-06  **INTERCHANGEABLE DRIVER SET**

With circuit testing driver handle for low voltage.
(AC80~250V/DC100~300V)
Contents: ⊕#1, #2, ⊖3, 5.5mm, ⊙5.5mm, awl

DK-08  **INTERCHANGEABLE DRIVER SET**

Contents: ⊙4, 5.5, 6, 7, 8, 10mm

DK-05P-06P  **INTERCHANGEABLE DRIVER SET**

- Cost-saving package in Plastic blow-mould case
- Contents exactly same as DK-05 & DK-06

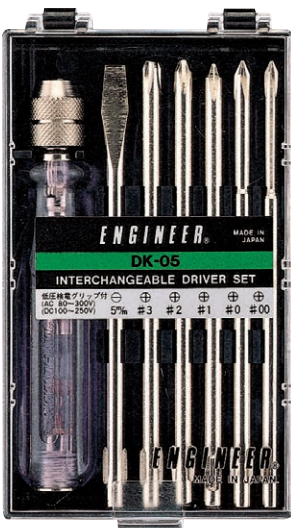

SCREW REMOVAL

SCISSORS

NIPPERS

PLIERS

CRIMPING STRIPPING

TWEEZERS

SCREW DRIVERS

SPECIAL DRIVERS

WRENCHES

CUTTING PROCESSING

SETS CASES

SOLDERING EQUIPMENT

ESD CHEMICALS

DA-48~52

CERAMIC ALIGNMENT SCREWDRIVER

Four-in-One Slotted Tip & Hex Core Ceramic Alignment Screwdrivers.

- Perfect non-conductive tip for high frequency trimming.
- Ideal alignment screwdriver for short-circuit prevention
- Four-in-one double ended tool.
- Pen-type design with protective caps and pocket clip.
- $\phi 8 \times 136$ mm long

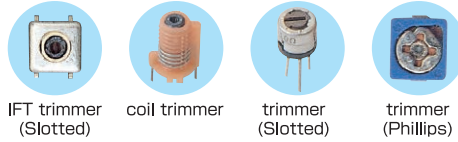

Item No.	Size	Core
DA-48	$\ominus 0.7 \times 1.3$	2
	$\ominus 0.4 \times 2.4$	2.5
DA-50	$\ominus 0.35 \times 0.8$	2
	$\oplus \#0$	-
DA-51	$\ominus 0.4 \times 0.9$	2
	$\ominus 0.4 \times 1.8$	2.5
DA-52	$\ominus 0.4 \times 1.3$	2
	$\ominus 0.7 \times 2.5$	2.5



Tips are made of fine, durable zirconia ceramic.



DK-90

CERAMIC ALIGNMENT SCREWDRIVER SET

Assortment of DA-48~52 (4pcs.)



DA-53~59

CERAMIC ALIGNMENT SCREWDRIVER

Pen type Ceramic Alignment Driver for service and assembly line work

- Two-in-one, slotted tip and hex, core (except DA-58)
- With pen-type cap for protection and portable use
- $\phi 9 \times 135$ mm long

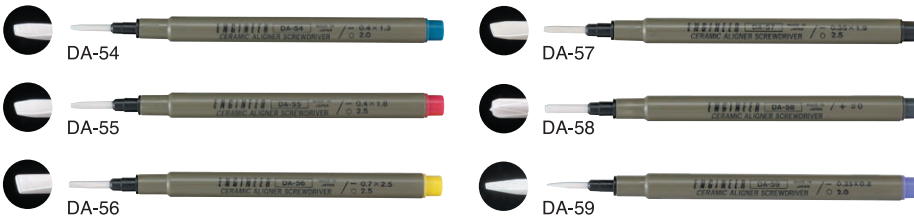

Item No.	Size	Core	Bottom color
DA-53	$\ominus 0.4 \times 0.9$	2.0	Green
DA-54	$\ominus 0.4 \times 1.3$	2.0	Blue
DA-55	$\ominus 0.4 \times 1.8$	2.5	Red
DA-56	$\ominus 0.7 \times 2.5$	2.5	Yellow
DA-57	$\ominus 0.35 \times 1.95$	2.5	Black
DA-58	$\oplus \#0$	-	Gray
DA-59	$\ominus 0.35 \times 0.8$	2.0	Purple

DA-72~79

CERAMIC ALIGNMENT SCREWDRIVER

The DA-70 series ceramic alignment screwdrivers are designed with a long slender shaft for a wider application of alignment in remote areas.

- Fine zirconia ceramic tipped alignment screwdrivers, highly intensive, durable, and perfectly non-conductive
- Slide-in shaft is attachable to other tools & equipment
- Long, slim design for easy access to remote areas
- Two-in-one, slotted tip and hex, core (except DA-78)

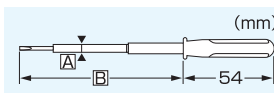

Item No.	Size	Core	A Size	B Size	Bottom color
DA-72	$\ominus 0.4 \times 2.4$	2.5	$\phi 4$	94	Orange
DA-73	$\ominus 0.4 \times 0.9$	2.0	$\phi 3.5$	95	Green
DA-74	$\ominus 0.4 \times 1.3$	2.0			Blue
DA-75	$\ominus 0.4 \times 1.8$	2.5			Red
DA-76	$\ominus 0.7 \times 2.5$	2.5	$\phi 4$	94	Yellow
DA-77	$\ominus 0.35 \times 1.95$	2.5			Black
DA-78	$\oplus \#0$	-		92	Gray
DA-79	$\ominus 0.35 \times 0.8$	2.0	$\phi 3.5$	95	Purple

DA-81~88



CERAMIC ALIGNMENT SCREWDRIVER

Compact designed ceramic alignment drivers. Perfect for assembly line trimming.

- Fine zirconia ceramic tipped alignment screwdrivers, highly intensive, durable, and perfectly non-conductive.
- Two-in-one function with slotted tip and hex core. (except DA-88)
- Ergonomically designed with convenient rotary cap.

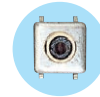

IFT trimmer (Slotted)

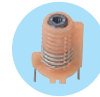

coil trimmer



trimmer (Slotted)



trimmer (Phillips)



DA-81



DA-85



DA-82



DA-86



DA-83



DA-87



DA-84



DA-88

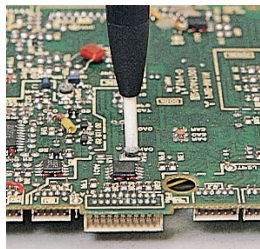
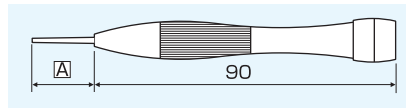

Item No.	Size	●Core	ASize	BOTTOM COLOR
DA-81	⊖0.7×1.3	2	18	Purple
DA-82	⊖0.4×2.4	2.5		Orange
DA-83	⊖0.4×0.9	2		Green
DA-84	⊖0.4×1.3	2		Blue
DA-85	⊖0.4×1.8	2.5		Red
DA-86	⊖0.7×2.5	2.5		Yellow
DA-87	⊖0.35×1.95	2.5	Black	
DA-88	⊕#0	—	15	Gray

DK-91



CERAMIC ALIGNMENT SCREWDRIVER SET

◇ Assortment of DA-81~88 (8pcs.)



DA-01·02



ALIGNMENT SCREWDRIVER

- Alignment tool for TV, tuner, trimmer under a high frequency current.

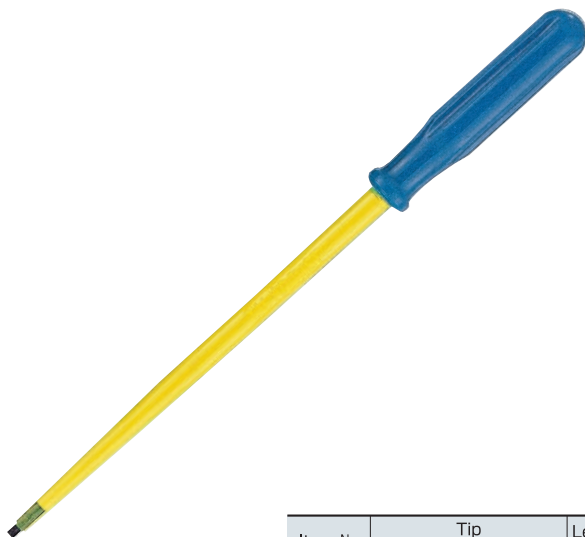

Item No.	Tip			Length of Rod	Handle
	Material	Thick	Width		
DA-01	SK steel	0.5	2.0	100	φ12×54
DA-02				150	

DA-40



ALIGNMENT SCREWDRIVER

- E.S.D. free construction (Safe from static discharge)
- Overall length: 125mm
- Tip: ⊖2×0.5 & ⊖2×0.5mm



SCREW REMOVAL

SCISSORS

NIPPERS

PLIERS

CRIMPING STRIPPING

TWEEZERS

SCREW DRIVERS

SPECIAL DRIVERS

WRENCHES

CUTTING PROCESSING

SETS CASES

SOLDERING EQUIPMENT

ESD CHEMICALS

Wrenches



SMART MONKEY WRENCH

Features

- Only 2mm-thick jaws fit in a narrow area.
- Ideal for fastening coaxial (BNC) connectors, double nut, etc.
- No damage given to housing of BNC connectors
- Accurately machined finish of thin edge
- Made of Chrome Vanadium steel
- Extra long jaws and wide opening type (TWM-07 & TWM-08)

TWM-03·07·08

SMART MONKEY WRENCH

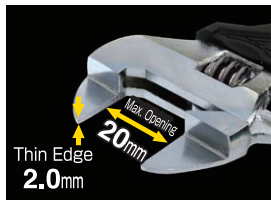

150mm size with soft handle

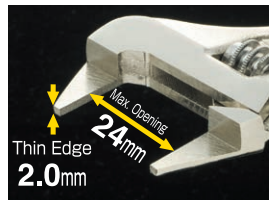

150mm size

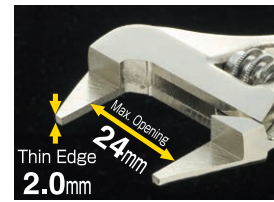

100mm size Stubby with cushioned handle (TPR)



TWM-03



TWM-07



TWM-08

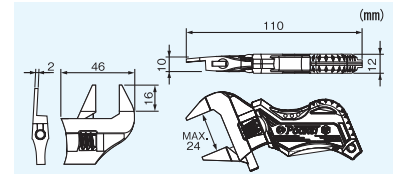
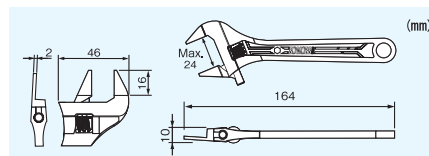
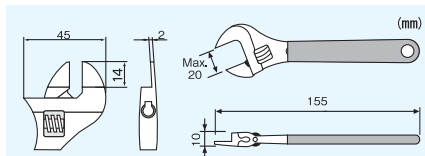

VARIOUS APPLICATIONS



TWM-01·02·04·05

ADJUSTABLE ANGLE WRENCH

- Heavy duty adjustable wrench
- Soft grip for easy handling.



TWM-04



TWM-02



TWM-01



TWM-05

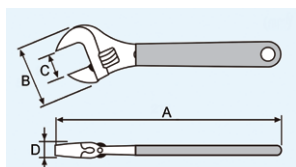

Item No.	Nominal Size	A	B	C	D
TWM-04	100	100	32	13	8
TWM-01	150	155	45	20	10
TWM-02	200	210	57	25	14
TWM-05	250	260	68	30	15

SCREW REMOVAL

SCISSORS

NIPPERS

PLIERS

CRIMPING STRIPPING

TWEEZERS

SCREW DRIVERS

SPECIAL DRIVERS

WRENCHES

CUTTING PROCESSING

SETS CASES

SOLDERING EQUIPMENT

ESD CHEMICALS

TS-04

MINI COMBINATION SPANNER SET

- 8-in-1 Combination spanner set with key chain
- Box-end inclined (30°)
- Thickness: 1.5mm
- Material: Stainless steel



◆ This item is individually available. (mm)

Item No.	Sizes		Thick	Length
	Box	Open		
TS-41	4.0	3.5	1.5	100
TS-42	4.5	4.0		106
TS-43	5.0	4.5		
TS-44	5.5	5.0		
TS-45	6.0	5.5	1.5	114
TS-46	6.5	6.0		
TS-47	7.0	6.5		
TS-48	8.0	7.0		

DROP-FORGED WRENCH SET

- Features
- 5-in-1 Set with carrying case
 - Material: Cr-V Steel

TS-05

OPEN-END WRENCH SET

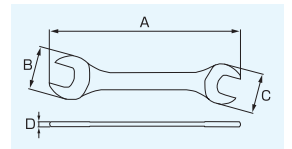

(mm)

Size	A	B	C	D	Wgt.(g)
3,2×5,5	70	13	10	2,4	7
4×5	70	13	10	2,4	7
6×7	80	16	14	2,7	12
8×9	90	20	18	3	17
10×11	100	23	21	3	23

TS-06

COMBINATION WRENCH SET

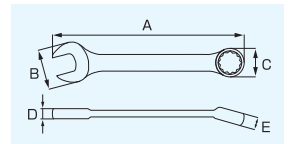

(mm)

Size	A	B	C	D	E	Wgt.(g)
3.2	77	10	6.5	3	3.1	7
3.5	77	10	6.5	3	3.1	7
4	77	10	7.5	3	3.1	7
5	82	11.8	9	3.2	4.1	9
5.5	82	11.8	9.5	3.2	4.1	9

TS-07

COMBINATION WRENCH SET

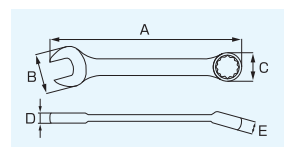

(mm)

Size	A	B	C	D	E	Wgt.(g)
6	88	15	10.4	3.8	5	14
7	88	15	11.5	3.8	5	14
8	94	17.2	12.5	4.3	6	20
9	98	19.4	14	4.6	6.2	23
10	103	21.5	15.3	5.1	6.6	29

TWB-01·02·04·05

IRoHS BALL POINT HEX WRENCH SET

Ball head (magnetized) works from an angle up to 30° off axis.

- Heat treated special alloy with electroless nickel plating
- Hardness : HRC57±2



TWB-01 8-in-1 Standard Long Shank



TWB-02 8-in-1 Stubby Arm, Long Shank

- Stubby arm accessible to restricted area where overhead space is tight

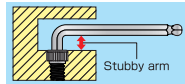

	TWB-01 (8 pcs./set)	TWB-02 (8 pcs./set)	TWB-04 (8 pcs./set)	TWB-05 (8 pcs./set)
Across Flat ● I (mm)	A x B (mm) (Individual model)	A x B (mm)	A x B (mm)	A x B (mm)
● 1.5	81 x 14 (TWB-15)	81 x 4	51 x 14	51 x 4
● 2.0	96 x 16 (TWB-20)	96 x 5	58 x 16	58 x 5
● 2.5	111 x 18 (TWB-25)	111 x 6	65 x 18	65 x 6
● 3.0	127 x 20 (TWB-30)	127 x 8	74 x 20	74 x 8
● 4.0	142 x 25 (TWB-40)	142 x 9	78 x 25	78 x 9
● 5.0	160 x 28 (TWB-50)	160 x 11	89 x 28	89 x 11
● 6.0	180 x 32 (TWB-60)	180 x 13	101 x 32	101 x 13
● 8.0	198 x 36 (TWB-80)	198 x 16	112 x 36	112 x 16

TWB-04 8-in-1 Standard Arm, Short Shank

- Hand-held compact sized body in bullet holder

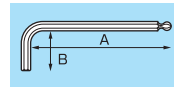

TWB-05 8-in-1 Stubby, Short Shank

- Stubby arm accessible to restricted area where overhead space is tight
- Hand-held compact sized body in bullet holder

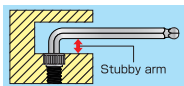

TWB-13~80 IRoHS BALL POINT HEX WRENCH

- Electroless nickel plated

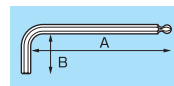

Item No.	Across Flats ● mm	A x B mm
TWB-13	1.27	70 x 13
TWB-15	1.5	81 x 14
TWB-20	2.0	96 x 16
TWB-25	2.5	111 x 18
TWB-30	3.0	127 x 20
TWB-40	4.0	142 x 25
TWB-50	5.0	160 x 28
TWB-60	6.0	180 x 32
TWB-80	8.0	198 x 36

TWH-01·02·04 IRoHS HEX KEY WRENCH SET

METRIC SIZE

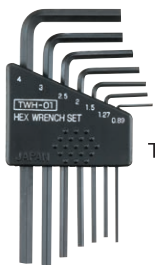

TWH-01

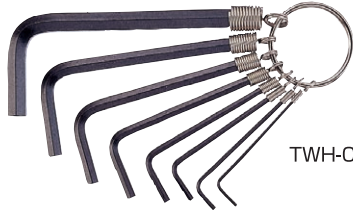

TWH-04

Item No.	pcs.	Set(mm)
TWH-01	7	0.89, 1.27, 1.5, 2.0, 2.5, 3.0, 4.0
TWH-04	8	1.5, 2.0, 2.5, 3.0, 4.0, 5.0, 6.0, 8.0

INCH SIZE



TWH-02

Item No.	pcs.	Set(inch)
TWH-02	7	0.71mm, 0.89mm, 0.05", 1/16", 5/64", 3/32", 7/64"

TWH-11~25 IRoHS HEX KEY WRENCH

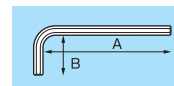

Hex Key Wrench in metric size

Item No.	Across Flats ● mm	L Size
TWH-11	1.5	45 x 14
TWH-12	2.0	50 x 16
TWH-13	2.5	56 x 18
TWH-14	3.0	63 x 20
TWH-15	4.0	70 x 25
TWH-16	5.0	80 x 28
TWH-17	6.0	90 x 32
TWH-18	8.0	100 x 36

Applicable Sizes Chart

Hex Across Flats	Cap Screw Diam.	Set Screw Diam.
1.27	M1.4	M2.5
1.5	M1.6, M2	M3
2.0	M2.5, M2.6	M4
2.5	M3	M5
3.0	M4	M6
4.0	M5	M8
5.0	M6	M10
6.0	M8	M12, M14
8.0	M10	M16, M18

Hex Key Wrench in inch size (mm)

Item No.	Across Flats	L Size
TWH-20	(0.71)	35 x 10
TWH-21	(0.89)	38 x 10
TWH-22	0.05"(1.27)	40 x 11.5
TWH-23	1/16"(1.59)	42.5 x 12.5
TWH-24	5/64"(1.98)	45.5 x 13.5
TWH-25	3/32"(2.38)	48.5 x 14.5

SCREW REMOVAL

SCISSORS

NIPPERS

PLIERS

CRIMPING STRIPPING

TWEEZERS

SCREW DRIVERS

SPECIAL DRIVERS

WRENCHES

CUTTING PROCESSING

SETS CASES

SOLDERING EQUIPMENT

ESD CHEMICALS

TWS-01~05

SOCKET WRENCH SET

- Socket wrench sets contain the complete combination of most needed sockets.
- Chrome molybdenum steel sockets and chrome vanadium ratchet handles.

TWS-05



TWS-05 Contents : 52pcs. per set

Contents	Size/Length(mm)
Sockets \varnothing 6.3(1/4")	4, 4.5, 5, 5.5, 6, 7, 8, 9, 10, 11, 13
	\varnothing 12.7(1/2") 10, 11, 12, 13, 14, 15, 17, 19, 22, 24, 27, 30, 32
Socket for 21mm plug	21 Across flats
Hex. Wrenches	1.5, 2, 2.5
Hex. Bits	3, 4, 5, 6, 7, 8
Phillips Bits	#1, #2, #3
Slotted Bits	4, 5.5, 7
Plastic Spinner Handle	200
Ratchet Handles	125, 300
Extension Shafts	100, 125, 250
T Type Sliding Handles	115, 300
Universal Joints	35, 70
Bit Adapters	25, 30
Steel Case	450×200×55

TWS-01·TWS-02



TWS-01 · 02 Contents : 16pcs. per set

Contents	Size/Length(mm)
Sockets \varnothing 6.3(1/4")	TWS-01 5/32, 3/16, 7/32, 1/4, 9/32, 5/16
	TWS-02 11/32, 3/8, 13/32, 7/16, 1/2 (inch) 9, 10, 11, 13 (mm)
Ratchet Handles	125
Extension Shafts	50, 150
Universal Handle	125
Cross Bar	115
Steel Case	180×120×30

TWS-03



TWS-03 Contents : 20pcs. per set

Contents	Size/Length (mm)
Sockets \varnothing 6.3(1/4")	4, 4.5, 5, 5.5, 6, 7, 8
	\varnothing 9.5(3/8") 9, 10, 12, 13, 14, 17, 19
Adaptor 3/8" → 1/4"	25
Plastic Spinner Handle	150
Ratchet Handle	200
Extension Shaft	75, 150
Socket for 21mm Plug	21 Across flats
Steel Case	292×145×35

TWS-04



TWS-04 Contents : 34pcs. per set

Contents	Size/Length(mm)
Sockets \varnothing 6.3(1/4")	4, 4.5, 5, 5.5, 6, 7, 8, 9, 10, 11, 13
Hex. Bits	3, 4, 5, 6, 8, 10
Phillips Bits	#1, #2, #3, #4
Slotted Bits	4, 5.5, 7
Hex Wrenches	1.5, 2, 2.5
Plastic Spinner Handle	150
Ratchet Handle	125
Extension Shaft	50, 100
T Type Sliding Handle	115
Universal Joint	35
Steel Case	200×110×30

- with quick drive ring



Cutting and Processing

TR-01~04

TAPER REAMER

- For reaming holes in sheet metal, aluminum and similar material
- Material : Carbon steel



(mm)			
Item No.	Size	Blade	Length
TR-01	φ3.0~12	81	113
TR-02	φ4.0~16	85	118
TR-03	φ5.0~20	95	130
TR-04	φ6.0~30	107	145

※Hardness: HRC 55±3

TDS-01·02·03

TWIST DRILL SET



TDS-01



TDS-02



TDS-03

		(mm)											
Item No.	Contents	0.3	0.4	0.5	0.6	0.7	0.8	0.9	1.0	1.2	1.5	2.0	2.5
TDS-01	5			●	●				●	●			
TDS-02	6						●		●	●	●	●	●
TDS-03	8	●	●	●	●	●	●	●	●				

TD-03~60

TWIST DRILL



(mm)		(mm)	
Item No.	Size	Item No.	Size
TD-03	0.3	TD-16	1.6
TD-04	0.4	TD-18	1.8
TD-05	0.5	TD-20	2.0
TD-06	0.6	TD-25	2.5
TD-07	0.7	TD-30	3.0
TD-08	0.8	TD-32	3.2
TD-09	0.9	TD-35	3.5
TD-10	1.0	TD-40	4.0
TD-12	1.2	TD-50	5.0
TD-15	1.5	TD-60	6.0

TT-01·02

TAP HANDLE

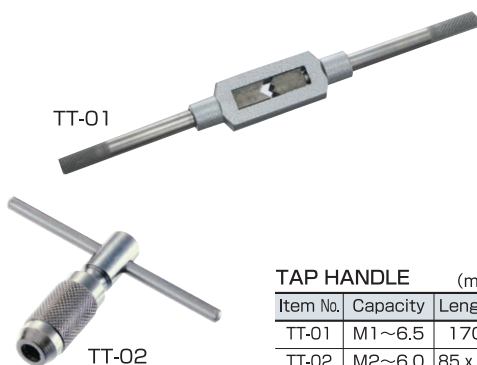

TAP HANDLE (mm)		
Item No.	Capacity	Length
TT-01	M1~6.5	170
TT-02	M2~6.0	85 x 60

TT-03·10~16

TAP/TAP SET



- Primary, Second & Finishing Taps (3pcs./set)



- ◀ TT-03 CONTENTS
- Tap, 4pcs(2, 3, 4, 5mm)
 - Tap Handle(TT-02)

TAP (mm)		
Item No.	Size	Pitch
TT-10	1.4	0.3
TT-11	1.7	0.35
TT-12	2.0	0.4
TT-13	3.0	0.5
TT-14	4.0	0.7
TT-15	5.0	0.8
TT-16	6.0	1.0

TP-20·23·24

MINI DRILL CHUCK/PIN VISE

- Used for various applications to drilling, tapping, piercing (handy reamer) grinding, etc.
- Featuring precision clamping chuck (collet)
- Material:Body-Brass Collet-Steel with plating

Fitting to electric driver with 2 pcs. of Single head collets

TP-20



Double ended shank (Through-hole body) with 2 pcs. of Double-head collets

TP-23



Single end with swivel head with 2 pcs. of Double-head collets

TP-24



Remove the swivel head to put a collet inside.



(mm)							
Item No.	Collet Type	Diameter of Drill Bit		Shank	Joint	O.A. Length	Weight (g)
TP-23	Double Head	⊕0.1~1.2	2.0~2.5	φ8	-	105	35
		⊕1.2~2.0	2.5~3.2				
TP-24	Double Head	⊕0.1~1.2	2.0~2.5	φ8	-	95	40
		⊕1.2~2.0	2.5~3.2				
TP-20	Single Head	⊕0.7~1.9		-	●6.3	50	20
		⊕1.9~3.0					

TV-01~27



TV-04



TV-14

- With special clasp ideal for thin plate, round bar and square lumber.
- The reverse of the clasp to be used as a flat clasp.



TV-26

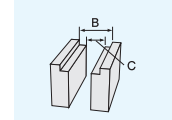

YANKEE VISE (mm)

Item No.	Size	Max. Opening	
		B	C
TV-25	50	61	55
TV-26	65	76	70
TV-27	75	84	78

BENCH VISE (mm)

Item No.	Size	Max. Opening	Clamp
TV-01	38	35	0~21
TV-02	50	35	0~32
TV-03	63	50	5~33
TV-04	75	50	18~40

ANVIL VISE (mm)

Item No.	Size	Max. Opening	Clamp
TV-11	38	35	0~25
TV-12	50	35	0~34
TV-13	63	45	20~45
TV-14	75	55	20~45

TN-01~05



- Light weight, durable and well-balanced frame design.
- Plastic handles are shaped for perfect grip without slip.
- Saw frame is designed to be adjustable in length and capable of using even broken pieces of saw blades. (TN-04/05)



TN-01



TN-02



TN-05

※Frame length adjustable(TN-04/05)

- Blade contained TN-17 (standard) TN-13&15 (spare)
- The ideal saw blades made of SKS special steel alloy with the technological know-how.
- Entirely heat treated, best quality saw blades available.

Item No.	Frame's Depth(mm)	Weight(g)
TN-01	125×75	170
TN-02	120×125	190
TN-03	110×280	240
*TN-04	~150×75	200
*TN-05	~150×125	220

TN-11~18 iRoHS SAW BLADES



TN-17

Item No.	Nominal Size	Blade Thick (mm)	Notches/25mm	Applications
TN-11	#3/0	0.24	61	Noble metals
TN-12	#2/0	0.26	56	Noble metals
TN-13	#0	0.28	53.5	Brass & thin Iron Sheet
TN-14	#1	0.30	51	Iron Sheet
TN-15	#2	0.34	43	Copper, Shell
TN-16	#3	0.36	40.5	Shell
TN-17	#4	0.38	38	Iron Sheet, Wood, Plastic
TN-18	#5	0.40	35.5	Plastic

TM-04·05



TM-04



Item No.	Scale
TM-04	15cm
TM-05	30cm

TZ-02~04



TZ-02 Adjustable blade



TZ-03



Item No.	Blade Size	Shape	Length
TZ-02	250mm24notches	Plastic Grip	260mm
TZ-03		Piping Frame	400mm

Die casting Aluminum handle

- Replacement blade [TZ-04] (12pcs/dozen)

TZ-05·07



SCRIBER
TZ-05
●210mm

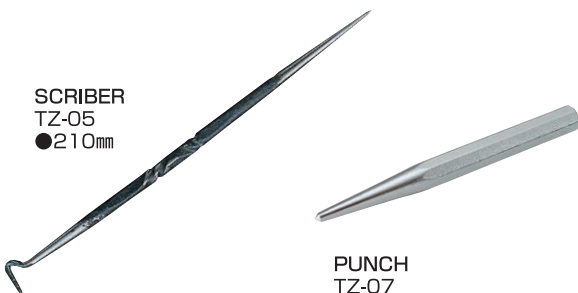

PUNCH
TZ-07
●100mm

TF-06·07·10



TF-07



TF-10



Item No.	Shape	Length(mm)	Grip
TF-06	□	200	Rubber
TF-07	○		
TF-10	△		

SCREW REMOVAL

SCISSORS

NIPPERS

PLIERS

CRIMPING STRIPPING

TWEEZERS

SCREW DRIVERS

SPECIAL DRIVERS

WRENCHES

CUTTING PROCESSING

SETS CASES

SOLDERING EQUIPMENT

ESD CHEMICALS

TF-11~45

High performance, Rust-resistant, Black coated files

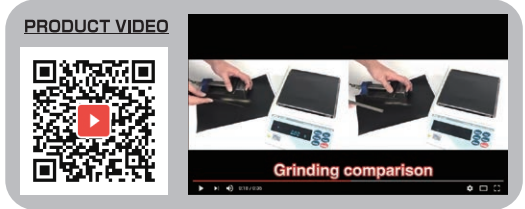

(mm)					
Item No.	Shape	Coarseness	Blade length	O.A. length	Wgt (g)
TF-11	□	Second-cut		215	58
TF-12	△				59
TF-13	○				41
TF-14	□				52
TF-15	△				56
TF-21	□	#3	100	200	21
TF-22	△				18
TF-23	○				16
TF-24	□				19
TF-25	△				17
TF-31	□	Smooth-cut		215	58
TF-32	△				61
TF-33	○				40
TF-34	□				55
TF-35	△				58
TF-41	□	Second-cut	175	325	166
TF-42	△				153
TF-43	○				109
TF-44	□			325	112
TF-45	△				166

ORDINARY FILES
Clogged with filing debris

Burr on each file tooth is eliminated before black coating, good for high and lasting performance of filing.

Sharp edge of teeth

Rust-resistant black coating

Side face
Smooth machined surface, ideal for filing a corner without damage. (TF-11, 21, 31, 41 only)

TFS-07·10·20·30 **RoHS JET BLACK FILE SET**

● A set of Jet Black Files in a roll-up storage with a strap



TFS-10 W240×L240(mm) W50×L240×H50(mm)

Item No.	Shape					Brush	Coarseness	Blade length	O.A.length	Wgt (g)
	□	△	○	□	△					
TFS-07	TF-11	TF-12	TF-13	□	△	-	Second-cut	100	215	274
	TF-21	TF-22	TF-23	-	-					
TFS-10	TF-11	TF-12	TF-13	TF-14	TF-15	○	Second-cut	100	215	349
TFS-20	TF-21	TF-22	TF-23	TF-24	TF-25	○	Precision	100	200	170
TFS-30	TF-31	TF-32	TF-33	TF-34	TF-35	○	Second-cut	100	215	371

TFS-01·02 **RoHS FILE SET**

NORMAL TYPE



TFS-01 TFS-02 (TF-06~10)

Item No.	Contents	□	△	○	□	△	Length(mm)
TFS-01	5	●	●	●	●	●	180
TFS-02	5	●	●	●	●	●	200

Sets and Cases



ENGINEER.

Even one of my belongings I replace on policy.
It is neither function nor design only. I represent to create myself
with an intellectual acting properties.

KS-01

 MY KIT

- Pocketable & reasonable kit for daily use



Set of 7 items

NSX-04	Micro nippers	115mm
PS-O4	Miniature pliers	115mm
PTS-01	Tweezers	125mm
DM-22	⊕Precision driver #3/0	
DM-33	⊖Precision driver 1.8mm	

DS-03	⊕Screwdriver	#00
DS-13	⊖Screwdriver	2.6×75

- Case : 135×90×30mm
- Weight : 0.25kg

KS-02

 MY KIT

- Simple & basic tool kit



Set of 11 items

NS-03	Micro nippers	125mm
PS-01	Miniature long nose pliers	125mm
PTS-01	Tweezers	125mm
DS-03	⊕Screwdriver	#00
DS-23	⊕Screwdriver	#0
DS-33	⊖Screwdriver	4×75

DH-15	Hex driver	1.5mm
DH-20	Hex driver	2.0mm
DH-25	Hex driver	2.5mm
	File(Half-round)	
	Cutter knife, S	

- Case : 220×145×35mm
- Weight : 0.5kg

KS-20

 MY KIT

- Pocket-sized and functional tool kit
- with Circuit testing driver handle



Set of 12 items

NN-45	Slant edge nippers	125mm
PR-15	Long nose pliers	125mm
PTS-01	Tweezers	125mm
	Phillips bit	⊕#00
	Phillips bit	⊕#1
	Phillips bit	⊕#2
	Slotted bit	⊖2.5mm
	Slotted bit	⊖3.5mm
	Slotted bit	⊖5.5mm
	Hex nut bit	⊖5.5mm
	Awl (square)	
	Cutter knife (S)	

- Case : 160×90×35mm
- Weight: 0.5kg



Circuit testing handle
(AC80~250V/DC100~300V)

KS-27

 MY KIT

- Pocket-sized tool kit, ideal for electronics
- with Penlight & Circuit testing driver



Set of 13 items

NS-03	Micro nippers	125mm
PS-01	Miniature long nose pliers	125mm
PT-06	Tweezers (J)	120mm
	Phillips bit	⊕#1
	Phillips bit	⊕#2
	Slotted bit	⊖3.5mm
	Slotted bit	⊖5.5mm
DM-22	⊕Precision driver	#000
DM-24	⊕Precision driver	#0
DM-32	⊕Precision driver	1.2mm
DM-34	⊖Precision driver	2.3mm
TWH-01	Hex key wrench set	
	Mini penlight (AAA type)	

- Case : 160×90×35mm
- Weight: 0.6kg



Circuit testing handle
(AC80~250V/DC100~300V)

KS-05 MAINTENANCE KIT

- For field maintenance service
- Environment-friendly polyester-made case (Lining: made of nylon)



Set of 13 items

NK-15	Diagonal nippers	125mm	PTS-01	Tweezers	125mm
PR-16	Long nose pliers	150mm	TWH-01	Hex key wrench set	
PC-06	Combination pliers	150mm	SKC-30	Soldering iron	26W
DS-03	⊕Screwdriver	#00	SW-30	Solder	20g
DS-23	⊕Screwdriver	#0		File (flat)	
DS-64	⊕Screwdriver	#2		●Case : 255×150×50mm	
DS-33	⊖Screwdriver	4×75		●Weight : 1kg	
DA-02	Alignment screwdriver	150mm			

⚡ Soldering Iron [220V~240V] available by assortment of SKC-30 as per Page 71

KSC-05 MAINTENANCE KIT

Cordless soldering iron (with Multi-holder) expands the utility of traditional tool kits.

- For field maintenance service
- Environment-friendly polyester-made case (Lining: made of nylon)

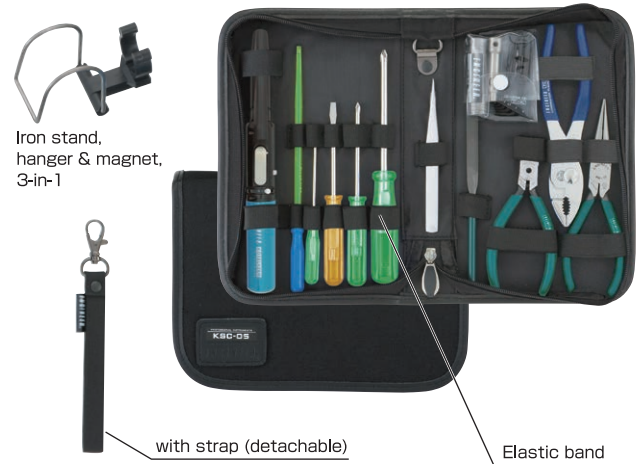

Set of 14 items

NK-15	Diagonal nippers	125mm	PTS-01	Tweezers	125mm
PR-16	Long nose pliers	150mm	TWH-01	Hex key wrench set	
PC-06	Combination pliers	150mm	SK-60	Cordless soldering iron(w/cap)	
DS-03	⊕Screwdriver	#00	SK-66	Hot blow tip	
DS-23	⊕Screwdriver	#0	SW-30	Solder	20g
DS-64	⊕Screwdriver	#2		File (flat)	
DS-33	⊖Screwdriver	4×75		●Case : 255×150×50mm	
DA-02	Alignment screwdriver	150mm		●Weight : 1kg	



Cordless soldering iron

KS-06(KSE-06) MAINTENANCE KIT

- For field maintenance service (Complete Set)



Set of 20 items

NN-46	Slant edge nippers	150mm	SKC-40	Soldering iron	32W
PR-16	Long nose pliers	150mm	SW-30	Solder	20g
PD-06	Side cutting pliers	150mm	TWM-02	Adjustable angle wrench	200mm
PC-06	Combination pliers	150mm		File (flat)	
PTS-02	Tweezers	125mm		File (round)	
DS-03	⊕Screwdriver	#00	TM-04	Steel rule	150mm
DS-23	⊕Screwdriver	#0	TWH-04	Hex key wrench set (8 pcs.)	
DS-64	⊕Screwdriver	#2		Cutter knife (S)	
DS-13	⊖Screwdriver	2.6×75		●Case : 305×220×45mm	
DS-54	⊖Screwdriver	5.5×100		●Weight : 2kg	
DN-05	Nut driver	5.5mm		⊕KSE-06 Case only	
DA-02	Alignment screwdriver	150mm			

⚡ Soldering Iron [220V~240V] available by assortment of SKC-30 as per Page 71

KSC-06 MAINTENANCE KIT

Cordless soldering iron (with Multi-holder) expands the utility of traditional tool kits.

- For field maintenance service (Complete Set)



Set of 21 items

NN-46	Slant edge nippers	150mm	SK-60	Cordless soldering iron(w/cap)	
PR-16	Long nose pliers	150mm	SK-66	Hot blow tip	
PD-06	Side cutting pliers	150mm	SW-30	Solder	20g
PC-06	Combination pliers	150mm	TWM-02	Adjustable angle wrench	200mm
PTS-02	Tweezers	125mm		File (flat)	
DS-03	⊕Screwdriver	#00		File (round)	
DS-23	⊕Screwdriver	#0	TM-04	Steel rule	150mm
DS-64	⊕Screwdriver	#2	TWH-04	Hex key wrench set (8 pcs.)	
DS-13	⊖Screwdriver	2.6×75		Cutter knife (S)	
DS-54	⊖Screwdriver	5.5×100		●Case : 305×220×45mm	
DN-05	Nut driver	5.5mm		●Weight : 2kg	
DA-02	Alignment screwdriver	150mm			



Cordless soldering iron

KS-03(KSE-03)

TOOL KIT

- General electronic & job training use



■Set of 12 items

NN-45	Slant edge nippers	125mm
PR-16	Long nose pliers	150mm
DS-03	⊕Screwdriver	#00
DS-23	⊕Screwdriver	#0
DS-64	⊕Screwdriver	#2
DS-33	⊖Screwdriver	4×75
DA-01	Alignment screwdriver	100mm
PTS-01	Tweezers	125mm
	Soldering iron	30W
	Solder	
	Solder paste	
	Soldering stand	

- Case : 240×115×45mm
- Weight : 0.8kg

◊ KSE-03 Case only

⚡ Soldering Iron [220V~240V] available by assortment of SK-14 as per Page 71

KS-04(KSE-04)

TOOL KIT

- General electronic & job training use
- Environment-friendly polyester-made case (Lining: made of nylon)



with strap (detachable)

Elastic band

■Set of 14 items

NN-45	Slant edge nippers	125mm	DN-05	Nut driver	5.5mm
PR-16	Long nose pliers	150mm	PTS-02	Tweezers	125mm
PD-06	Side cutting pliers	150mm	SKC-30	Soldering iron	26W
DS-03	⊕Screwdriver	#00		Solder	
DS-23	⊕Screwdriver	#0		Solder Paste	
DS-64	⊕Screwdriver	#2		Soldering stand	
DS-33	⊖Screwdriver	4×75		Cutter knife (S)	

- Case : 255×150×50mm
- Weight : 1.1kg

◊ KSE-04 Case only

⚡ Soldering Iron [220V~240V] available by assortment of SKC-30 as per Page 71

KSC-04

TOOL KIT

Cordless soldering iron (with Multi-holder) expands the utility of traditional tool kits.

- General electronic & job training use
- Environment-friendly polyester-made case (Lining: made of nylon)



Iron stand, hanger & magnet, 3-in-1

with strap (detachable)

Elastic band

⚡ Cordless soldering iron

■Set of 15 items

NN-45	Slant edge nippers	125mm	DS-33	⊖Screwdriver	4×75
PD-06	Side cutting pliers	150mm	SK-60	Cordless soldering iron(w/cap)	
PR-16	Long nose pliers	150mm	SK-66	Hot blow tip	
PTS-02	Tweezers	125mm		Solder	
DN-05	Nut driver	5.5mm		Solder Paste	
DS-03	⊕Screwdriver	#00		Soldering stand	
DS-23	⊕Screwdriver	#0		Cutter knife (S)	
DS-64	⊕Screwdriver	#2			

- Case : 255×150×50mm
- Weight : 1.1kg

KS-08

ELECTRONICS KIT

- For electronics, PC maintenance, PC modification, etc.
- Environment-friendly polyester-made case (Lining: made of nylon)



■Set of 21 items

NS-03	Micro nippers	125mm
PS-01	Miniature long nose pliers	125mm
PTS-01	Tweezers	125mm
SS-01	Solder sucker	
SS-08	IC extractor	
SS-22	Spring hook	
	Soldering iron	30W
SL-02	Inspection mirror	
SWU-04	Solder wick	2.8mm
	Solder (1m)	
TWH-01	Hex key wrench set	
DN-05	Nut driver	5.5mm
DM-22	⊕Precision driver	#000
DM-33	⊖Precision driver	1.8mm
	Phillips bit	⊕#00
	Phillips bit	⊕#0
	Phillips bit	⊕#1
	Phillips bit	⊕#2
	Slotted bit	⊖3.5mm
	Cutter knife (S)	
	File (half-round)	

- Case : 255×150×50mm
- Weight : 1.0kg

KS-14

- For electronics, office automation maintenance, etc.
- Environment-friendly polyester-made case (Lining: made of nylon)

■ Set of 18 items

NS-03	Micro nippers	125mm
PR-16	Long nose pliers	150mm
PTS-01	Tweezers	125mm
PZ-56	Screw removal pliers	175mm
DP-03	Pro-use driver	⊕#00
DP-24	Pro-use driver	⊕#0
DP-64	Pro-use driver	⊕#2
DP-34	Pro-use driver	⊖4.3mm
DN-05	Nut driver	5.5mm
	Mini spanner	5.5×6
	Mini spanner	8×9
TM-04	Steel rule	150mm
TZ-05	Scriber	220mm
TWH-01	Hex key wrench set	
TWM-03	Smart monkey wrench	150mm
SL-02	Inspection mirror	
	Cutter knife (S)	
	File (half-round)	

- Case : 250×180×50mm
- Weight : 1.3kg

KS-28(KSE-28)

TOOL KIT

Basic assortment of general purpose tools and free space in mesh pocket for your own use

- Soft touch EVA plastic case with double panel
- A4 size pocket is provided on the reverse of upper panel which is capable of documents, measuring instrument or notebook P.C. (max. 40mm thick)
- Tool panel is easily detachable with hook, which is convenient for field work.



330mm wide pocket on the reverse



● Free space in mesh pocket

● Clear pocket (detachable)

■ KS-28 Set of 22 items

NN-46	Slant edge nippers	150mm
PR-16	Long nose pliers	150mm
PD-06	Side cutting pliers	150mm
PZ-55	Screw removal pliers	150mm
PW-08	Pump pliers	200mm
PTS-01	Tweezers	125mm
DA-01	Alignment driver	100mm
DKD-01	Circuit testing driver	
DN-05	Nut driver	5.5mm
DG-05	⊕/⊖ Cushion driver	#2/⊖6
DG-21	⊖ Mini soft driver	3×100mm
DG-24	⊕ Mini soft driver	#0×100mm

SKC-30	Soldering iron	26W
SS-05	Tip cleaner with stand	
SW-30	Solder	20g
	File (half-round)	
	Measuring tape	2m
TS-05	Open-End wrench set	
TWH-01	Hex key wrench set	
TWM-02	Adjustable angle wrench	200mm
	Cutter knife (S)	
	Vinyl tape	

- Case : 405×306×100mm (Ext.)
380×276×73mm (Int.)
- Weight : 3.7kg

◆ **KSE-28** Case and panel 1.8kg

⚡ Soldering Iron [220V~240V] available by assortment of SKC-30 as per Page 71



Cordless Soldering Iron can be assorted instead of SKC-30 at customer's option.

KS-11 (KSE-11)

TOOL KIT

Field service and maintenance of production lines & machinery

KS-11 (Tool kit)

KSE-11 (Case and panel only) - Net 5 kg



■ Set of 60 items

NS-03	Micro nippers	125mm
NN-46	Slant edge nippers	150mm
PS-01	Miniature pliers	125mm
PR-46	Needle nose pliers	150mm
PD-06	Side cutting pliers	150mm
PC-06	Combination pliers	150mm
PW-10	Pump pliers	250mm
PA-01	Wire pliers	
PT-01	Tweezers	125mm
PH-03	Lock holder	150mm
PH-33	Electronic snips	145mm
DS-03	⊕Screwdriver	#00
DS-24	⊕Screwdriver	#0
DS-44	⊕Screwdriver	#1
DS-64	⊕Screwdriver	#2
DS-13	⊖Screwdriver	2.6×75
DS-34	⊖Screwdriver	4×100
DA-02	Alignment driver	150mm
DM-22	⊕Precision driver	#3/0
DM-23	⊕Precision driver	#00
DM-33	⊖Precision driver	1.8mm
DM-34	⊖Precision driver	2.3mm
DZ-24	Screw-holding driver	#0
DG-12	Long pro-grip driver	#2×250mm
DN-02	Nut driver	4mm
DN-04	Nut driver	5mm
DN-05	Nut driver	5.5mm
DN-07	Nut driver	7mm
DN-08	Nut driver	8mm
DR-04	Ratchet stubby driver set	
DZ-08	Offset driver set	
TWM-02	Adjustable angle wrench	200mm
TS-05	Mini spanner set (5 pcs.)	
TR-03	Taper reamer	20mm
	Hammer	
	Measuring tape	2m
TWH-01	Hex key wrench set	
TWS-02	Socket wrench set	
TFS-02	File set	
TZ-02	Handy saw	
SKC-40	Soldering iron	32W
SW-31	Solder	150g
SS-05	Tip cleaner with stand	
SS-02	Solder sucker	
SS-08	IC Extractor	
SS-21	Spring hook	
SS-22	Spring hook	
SL-03	Inspection mirror	
TP-35	Magnetic pick-up tool	
KP-03K	Parts box	
SWU-04	Solder wick	2.8mm
	Vinyl tape	
	Pen light	
	Cutter knife (L)	
ZC-19	Oil	20cc
	Flat brush	
	Poly bottle	50cc/2pcs.
	Poly bottle	100cc/2pcs.
	Silicon cloth	
SD-10	Digital Multimeter	

● Aluminum Case :
455×330×176 (Ext.)
440×315×168 (Int.)
● Weight : 12kg

⚡ Soldering Iron [220V~240V] available by assortment of SKC-30 as per Page 71

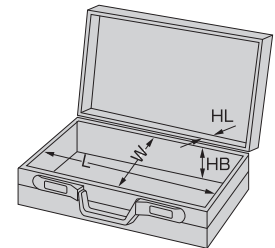

H=HL+HB



KS-12

ATTACHE TOOL KIT

Stylish and functional tool kit



■ Set of 25 items

NS-03	Micro nippers	125mm
PS-01	Miniature pliers	125mm
PD-06	Side cutting pliers	150mm
PTS-01	Tweezers	125mm
DA-51	Ceramic alignment driver	
DG-21	⊖Mini soft driver	3×0.4
DG-22	⊕Mini soft driver	#00
DG-24	⊕Mini soft driver	#0
DG-01	⊖Pro grip driver	5.5×0.7
DG-04	⊕Pro grip driver	#2
DST-05	⊕⊖Reversible stubby driver	#2/⊖6.3
SD-10	Digital multimeter	
SKC-30	Soldering iron	26W
SS-02	Solder sucker	
SS-08	IC extractor	
SS-10	PCB connector extractor	
SW-30	Solder	20g
TWM-03	Smart monkey wrench	150mm
TWH-04	Hex key wrench set	
TS-05	Mini spanner set (5 pcs.)	
TM-04	Steel rule	150mm
PA-06	Wire stripper	
SWU-04	Solder wick	2.8mm
SL-50	Pocket loupe	
	Cutter knife (S)	

● Dividing plate for soldering box & tester



Item No.	L	W	H	HL	HB	Weight(kg)	Color
KS-12	465 (450)	345 (320)	129 (105)	(35)	(70)	6	Black

() : Internal size

⚡ Soldering Iron [220V~240V] available by assortment of SKC-30 as per Page 71

KSE-12

iRoHS ATTACHE CASE WITH EMPTY PANEL

- Neatly designed for a stylish appearance
- Incorporating empty tool panel and document pocket



Dividing panel is easily detachable with Velcro.

- Speedy and easy attachment of empty panel

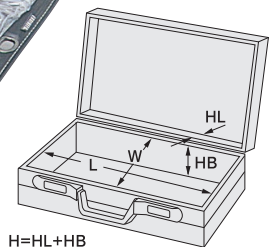

$$H=HL+HB$$

(mm)

Item No.	L	W	H	HL	HB	Weight(kg)	Color
KSE-12	465 (450)	345 (320)	129 (105)	(35)	(70)	3.3	Black

() : Internal size

KA-22

iRoHS ATTACHE CASE (WIDE TYPE)

Attractive and functional multipurpose case

- Light-weighted & durable case made of ABS resin
- Nylon 100% (Hypalon) interior finish for more than just business
- Tool panel (option) can be hidden from free space by dividing plate.
- Comes with multipurpose pockets

BODY

This handsome case is molded of ABS plastic with simple form line, lightweight and durable construction. Suggest a new field of use and produce the joy in possession of the case.

DIAL LOCK

Add security with combination dial lock and two pushing locks. Open easily by sliding outside the 2 buttons.



INSIDE

Besides business use, add functional and fashionable pockets and storage pouch to meet multipurpose requirements. Offer clear see-through mesh type pocket at the back of dividing plate.

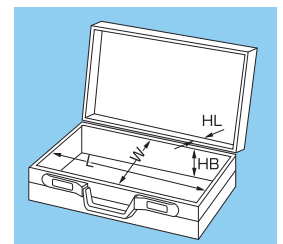

(Remark)

The dimensions indicate the internal sizes but subject to within a tolerance allowed.
H=HL+HB



HANDLE

Designed to fit the hand and reduce hand fatigue.

Item No.	L	W	H	HL	HB	Weight(kg)	Color
KA-22	450	320	105	35	74	2.4	Black

(mm)

SCREW REMOVAL

SCISSORS

NIPPERS

PLIERS

CRIMPING STRIPPING

TWEEZERS

SCREW DRIVERS

SPECIAL DRIVERS

WRENCHES

CUTTING PROCESSING

SETS CASES

SOLDERING EQUIPMENT

ESD CHEMICALS

KA-15

RoHS ABS ATTACHE CASE

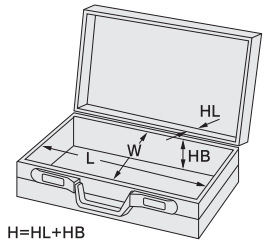

(mm)						
Item	L	W	H	HL	HB	Weight(kg)
KA-15	440	320	92	32	60	2

KA-50·51

RoHS ALUMINIUM CASE

- Featuring a matt surface in silver color
- Streamline appearance



● Durable handle

Internal Size (mm)						
Item	L	W	H	HL	HB	Weight(kg)
KA-50	440	320	105	40	65	2.6
KA-51	440	320	130	50	80	2.8

KA-57

RoHS ALUMINIUM CASE

- Stylish case coming with shock-proof sponges and tool panel



Tool panel affixed to shell with Velcro and detachable

Wavy formed urethane (upper shell) and cut sponges (body) protect contents such as camera, camcorder, etc.

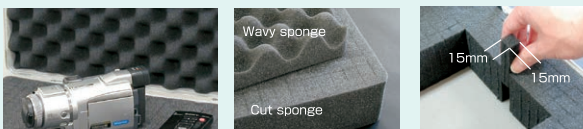

Each cut sponge (15x15mm) can be removed so as to fit the size and shape of content.

External dimensions (Internal dimensions) (mm)							
Item No.	L	W	H	HL	HB	Tool Panel (single)	Weight(kg)
KA-57	450(435)	330(314)	135(120)	(52)	(68)	420×300	4.1

KA-30·42~44

ALUMINIUM CASE

- Heavy-duty type
- Made of 1.5mm-thick rugged aluminium of anodized finish
- All the corners reinforced with aluminum frame and rivets
- Case inside in melton finish



●Durable handle

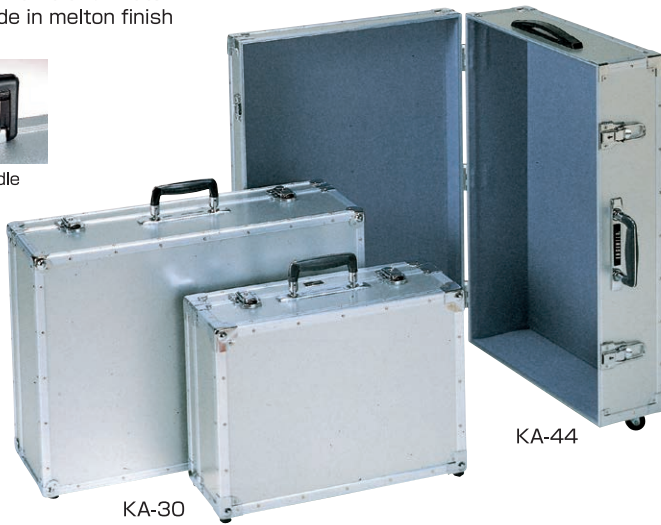

KA-30

KA-44



Water-repellent, anti-static or cleanroom type is available at option.



KA-44 is originally equipped with casters. Other models can be equipped with casters at option.

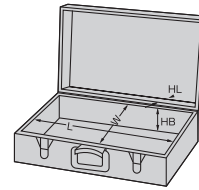

(Remark)
The dimensions indicate the internal sizes but subject to within a tolerance allowed.
H = HL+HB

Item No.	Internal Size (mm)					(kg)	
	L	W	H	HL	HB	Wgt.	Max.Load
KA-30	440	315	165	55	110	4.3	15
KA-42	540	320	160	50	110	4.6	
KA-43	590	410	205	50	155	6.2	20
KA-44	650	450	197	60	137	7.4	

KAC-30·42

ALUMINIUM CASE FOR CLEANROOM

- Constructed of aluminum sheets without any accessories nor material generating dust
- KAC-42 is ideal for storage of precision instruments in cleanroom



KAC-30

KAC-42



●Durable handle

Item No.	Internal Size (mm)					(kg)	
	L	W	H	HL	HB	Wgt.	Max.Load
KAC-30	440	315	165	55	110	4	15
KAC-42	540	320	160	50	110	4.7	

KA-54

ALUMINIUM ATTACHE CASE

- Featuring a glossy surface in black color Streamline appearance



Item	(mm)					
	L	W	H	HL	HB	Weight(kg)
KA-54	440	320	130	50	80	2.8

SCREW REMOVAL

SCISSORS

NIPPERS

PLIERS

CRIMPING STRIPPING

TWEEZERS

SCREW DRIVERS

SPECIAL DRIVERS

WRENCHES

CUTTING PROCESSING

SETS CASES

SOLDERING EQUIPMENT

ESD CHEMICALS

KP-01~03(KP-95~97)

Durable transparent box, ideal for transporting, classification and storage of small parts.

- Lightweight, compact and durable component box made of polypropylene
- Interchangeable dividing plates can be configured to create storage space
- See-through, transparent box.
- With article labels.

- ◇ Optional dividing plate set
 KP-95 : 6 pcs./set adaptable to KP-01
 KP-96 : 6 pcs./set adaptable to KP-02
 KP-97 : 6 pcs./set adaptable to KP-03



- KP-01
 Ext. Size : 157×102×42mm
 4 pcs. of dividing plates included



- KP-02
 Ext. Size : 207×145×40mm
 12 pcs. of dividing plates included



- KP-03
 Ext. Size : 255×190×40mm
 16 pcs. of dividing plates included

KP-02K·03K(KP-96·97)

Heavy duty transparent parts box, ideal for classification and storage

- Super clear transparent lid owing to shock-proof polycarbonate resin
- Micro-rib system of divider setting
- Material: Lid - Polycarbonate
 Body & Divider - Polypropylene
 Latch - ABS resin

- ◇ Optional dividing plate set
 KP-96 : 6 pcs./set adaptable to KP-02K
 KP-97 : 6 pcs./set adaptable to KP-03K



- KP-02K
 Ext. Size : 205×145×40mm
 18 pcs. of dividers included

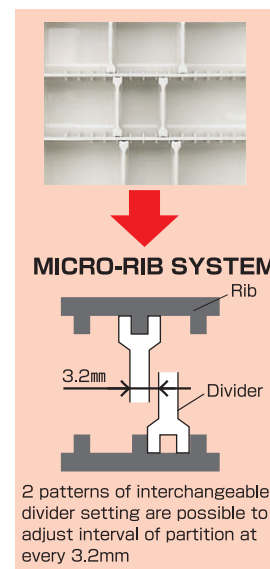

- KP-03K
 Ext. Size : 255×190×40mm
 32 pcs. of dividers included

KP-04

MINIATURE BOX

- Most suitable for electronic parts and other small components.
- Compact, lightweight and portable.
- Material: Styrene resin(lid), Polypropylene (body).
- External Size: 120×92×25mm

KP-51·52

- Compact IC storage box made of anti-static plastic body
- Comes with 10mm-thick high density conductive foam (Surface resistivity less than $5 \times 10^6 \Omega$)



- KP-51
 ● External Size : 80×135×25
 ● Internal Size : 75×130×19



- KP-52
 ● External Size : 230×145×28
 ● Internal Size : 219×134×22

Soldering Equipment



SK-30/40SERIES

SOLDERING IRON

Excellent built-in ceramic heater. Compact & light-weight design suitable for accurate soldering operations

- High efficient ceramic heater permits quick heat-up, enabling soldering operation only in about 1 minute.
- The use of a small connector connecting heater and power cord permits exchange of heaters with one touch.
- Short length from grip to tip for easy operation
- Screw type tip permits easy exchange of tips.
- Perfect for accurate soldering operation with sharp soldering tip (long life and non corrosive).
- With heat-resistance cap for handy storage after use. (SKC-30/31/32/40/41)

■SK-30~41

Grip made of reinforced glass fiber resin.

SK-30



■SKC-30~41

With Heat-Resistant Cap.

SKC-32



SK-30/40SERIES Three functions

1



Sharp iron tip
(Long life & durable type)

2

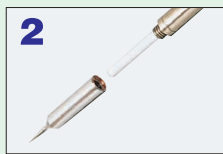

Special stainless steel Plug-in type heater for inside tip for prevention against sticking and loosening of the tip

3

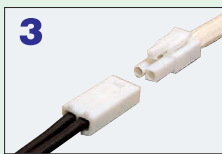

■Time/Temp. Chart

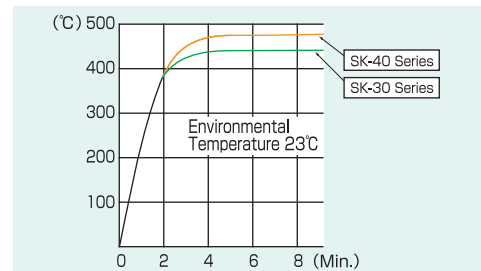

SK-30 SERIES

■Specification

Item No.	Max.Tip Temp.	Watt	Tip	L'gth	Wgt(g)	Rated Voltage	Insulation Resistance
SK-30	400°C	26W	ST-10	202mm	130	100V	100MΩ
SKC-30			ST-11				
SKE-30			ST-14				
SK-31	440°C	26W	ST-10	202mm	130	100V	100MΩ
SKC-31			ST-11				
SKE-31			ST-14				
SK-32	390°C	26W	ST-10	202mm	130	100V	100MΩ
SKC-32			ST-14				

■ SKC with Heat-Resistant Cap. ■ SKE with 3-pin plug.

⚡ 220V 230V 240V are also available. REF. Page 71

Caution Ceramic heater is not elastic and may be broken by excess shock. Please refrain from beating and wrenching.

■REPLACEMENT PARTS

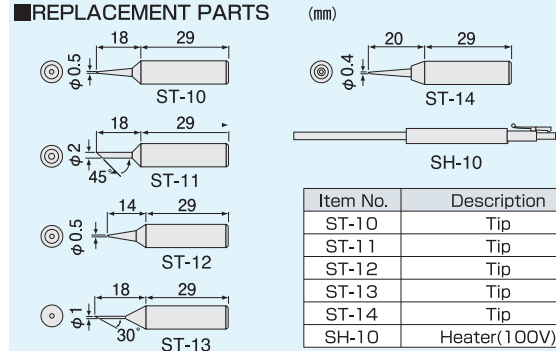

SK-40 SERIES

■Specification

Item No.	Max.Tip Temp.	Watt	Tip	L'gth	Wgt(g)	Rated Voltage	Insulation Resistance
SK-40	450°C	32W	ST-20	204mm	130	100V	100MΩ
SKC-40			ST-21				
SK-41	470°C	32W	ST-20	204mm	130	100V	100MΩ
SKC-41			ST-21				

■ SKC with Heat-Resistant Cap.

Caution Ceramic heater is not elastic and may be broken by excess shock. Please refrain from beating and wrenching.

■REPLACEMENT PARTS

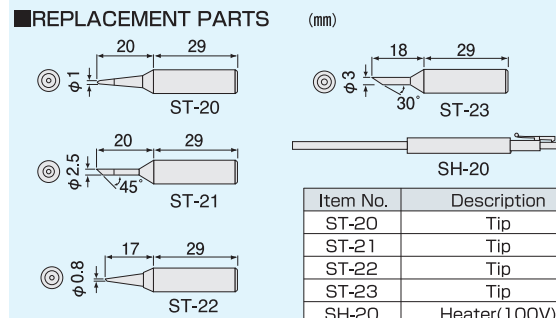

SK-30 SERIES

SOLDERING IRON

Excellent built-in ceramic heater. Compact & light-weight design suitable for accurate soldering operations

- High efficient ceramic heater permits quick heat-up, enabling soldering operation only in about 1 minute.
- The use of a small connector connecting heater and power cord permits exchange of heaters with one touch.
- Short length from grip to tip for easy operation
- Screw type tip permits easy exchange of tips.
- Perfect for accurate soldering operation with sharp soldering tip (long life and non corrosive).
- With heat-resistance cap for handy storage after use. (SKC-30/31)

■SK-30~31

Grip made of reinforced glass fiber resin.



■SKC-30~31

With Heat-Resistant Cap.



■SKE-30~31

With 3-Pin plug to avoid damage of elements caused by electric leakage.



SK-30SERIES Three functions

1



Sharp iron tip
(Long life & durable type)

2



Special stainless steel
inside tip for prevention
against sticking and
loosening of the tip

3



Plug-in type heater for
instant replacement

■Time/Temp. Chart

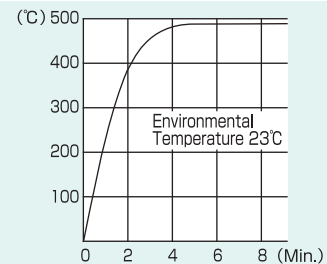

SK-30 SERIES

■Specification

Item No.	Max. Tip Temp.	Watt	Tip	L'gth	Wgt(g)	Rated Voltage	Insulation Resistance
SK-30	445°C	30W	ST-20	204mm	130	220 240V	100MΩ
SKC-30							
SKE-30							
SK-31	500°C	30W	ST-21	204mm	130	220 240V	100MΩ
SKC-31							
SKE-31							

■ST-22 Max. Tip Temp. 430°C ■ST-23 Max. Tip Temp. 500°C

Caution Ceramic heater is not elastic and may be broken by excess shock.
Please refrain from beating and wrenching.

■REPLACEMENT PARTS

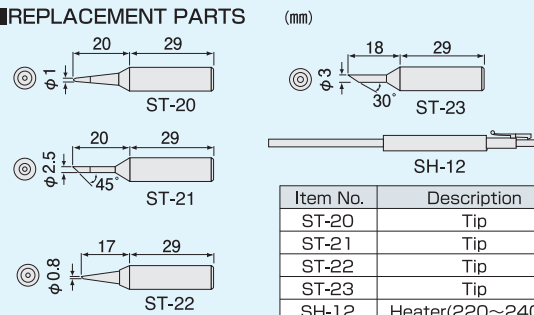

SCREW REMOVAL

SCISSORS

NIPPERS

PLIERS

CRIMPING STRIPPING

TWEEZERS

SCREW DRIVERS

SPECIAL DRIVERS

WRENCHES

CUTTING PROCESSING

SETS CASES

SOLDERING EQUIPMENT

ESD CHEMICALS

SK-60SERIES

Newly designed compact body with various functions!

- Perfect for in-field service and maintenance where accessibility may be limited.
- Light weight for fatigue free use.
- One touch ignition and super quick heat-up (equivalent up to 60 watts).
- More than one hour continuous use capacity.



Completely cordless assures no electric leakage, no E.M.I. and free from voltage problem.



Arts, craft, and hobby use such as plastic shaping and rope cutting.



Three-in-one heat tool with soldering, hot blow, and hot knife

- SKB-60 Contents
- Body (SK-61 solder tip)
 - Hot blow tip
 - Hot knife tip
 - Multi-holder
 - Protective cap



- SKA-60 Contents
- Body(SK-61 solder tip)
 - Hot blow tip
 - Multi-holder
 - Protective cap



Pin point accurate hot air for shrink tubing and plastic welding.

Kotelyzer(SK-60)Specifications

System		Gas Catalyst Reaction System
Thermal Output	Soldering Iron	200°C~450°C (Equivalent to 15~60W electric soldering iron)
	Hot Blow	650°C MAX
Gas Container Capa.		14ml
Operation Time for One Gas Fill		Abt 1 hour 15min.
O.A. Length		216mm including cap
Weight		66g



Two-in-one heat tool with soldering and hot blow.

- SKC-60 Contents
- Body(SK-61 solder tip)
 - Hot blow tip
 - Protective cap
 - Cleaner stand

SK-60SERIES

REPLACEMENT PARTS

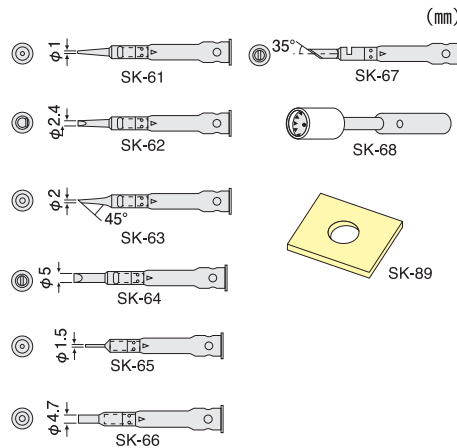

Item No.	Description
SK-61	Tapered needle
SK-62	Chisel
SK-63	φ2mm spade
SK-64	Chisel
SK-65	Hot blow tip
SK-66	Hot blow tip
SK-67	Hot knife
SK-68	Ceramic unit
SK-89	Cleaning sponge

● Multi-Holder is not saleable separately.

SS-08

IC EXTRACTOR

- Ideal for extracting 8~42 pins ICs in one single operation.
- Squeeze clip and hold ICs tightly.
- Overall Length : 125mm



SS-10

PC BOARD CONNECTOR EXTRACTOR

- Ideal for insertion or extraction of housing connectors on the PC boards.
- Holds PC board connectors with accurately machined tip, picking them uprightly and smoothly without a cut of wire or deformity.
- Accurate tip design to insert or extract PCB connectors (straight type & right-angle type) mounted on dense PCB
- Overall Length : 112mm



SK-70SERIES

Multi-holder creates new field of cordless soldering iron!

- Perfect for in-field service and maintenance where instant heat is required.
- Super quick heat up with one touch operation.
- Completely cordless assures no electric leakage no E.M.I.
- Flameless and safe heat generating system by gas catalyst reaction.
- Variable temperature control (equivalent to 20-80 watts).

■ Telecommunication field

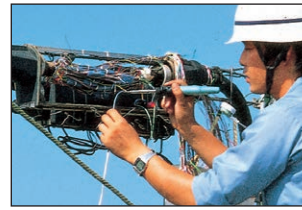

SKD-70 set comes with a high-power tip for cable maintenance tasks and an accurate tip for telephone office service.

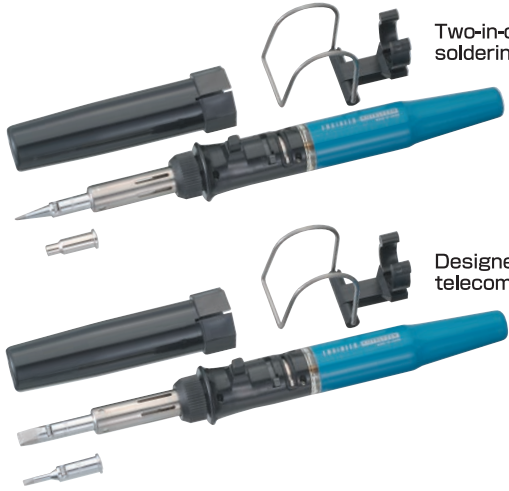

Two-in-one heat tool with soldering and hot blow.

- SKC-70 Contents
- Body(SK-71 solder tip)
 - Hot blow tip
 - Multi-holder
 - Protective cap

- SKA-70 Contents
- Body(SK-71 solder tip)
 - Hot blow tip
 - Protective cap

- SKB-70 Contents
- Body(SK-71 solder tip)
 - Hot blow tip

Designed to perform telecommunication tasks.

- SKD-70 Contents
- Body(SK-79 solder tip)
 - Solder tip(SK-72)
 - Multi-holder
 - Protective cap

■ Kotelyzer (SK-70) Specifications

System		Gas Catalyst Reaction System
Thermal Output	Soldering Iron	200°C~500°C (Equivalent to 20~80W electric soldering iron)
	Hot Blow	650°C MAX
Gas Container Capa.		28ml
Operation Time for One Gas Fill		Abt 4 hours (Lever position : 2)
O.A.Length		281mm including cap
Weight		110g

Three function of Multi-holder assures safe and wide task field !

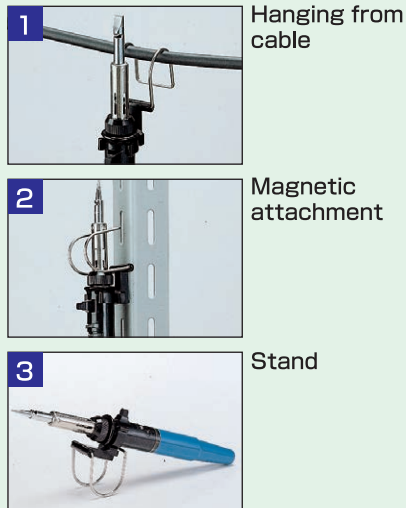

1 Hanging from cable

2 Magnetic attachment

3 Stand

Multi-Holder is useable for both SK-60 series and SK-70 series.

SK-70SERIES

REPLACEMENT PARTS

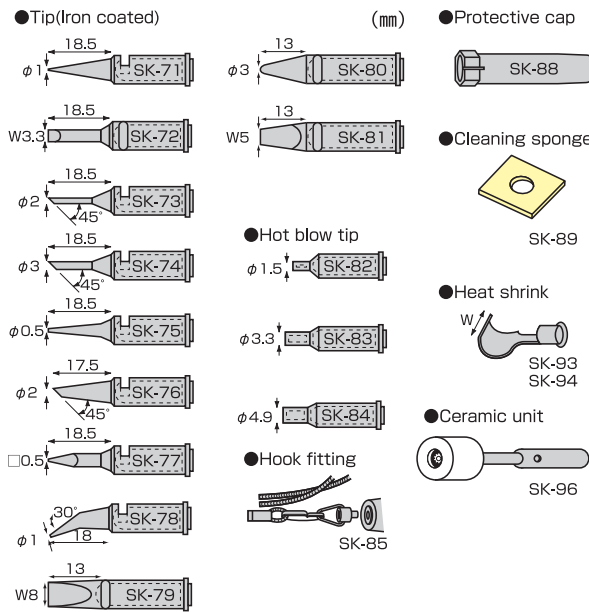

Item No.	Description
SK-71	Tapered needle
SK-72	Chisel
SK-73	φ2mm spade
SK-74	φ3mm spade
SK-75	Tapered needle
SK-76	φ2mm spade
SK-77	Tapered pyramid
SK-78	Offset tapered needle
SK-79	High powered chisel
SK-80	High powered round head needle
SK-81	High powered long taper chisel
SK-82	Hot blow tip
SK-83	Hot blow tip
SK-84	Hot blow tip
SK-85	Hook fitting
SK-88	Protective cap
SK-89	Cleaning sponge
SK-93	Heat shrink W-22
SK-94	Heat shrink W-18
SK-96	Ceramic unit

SKM-40·SK-42~47

HANDY KOTELYZER

SK-90·95

GAS REFILL

- Advanced and streamlined design
- Hot blow & powerful torch
- Improved heat-generating structure of metal catalyst
- Come with cleaner stand & solder
- Capable of continuous use in one hour

- Please use our original gas for refill. (Butane liquefied odorless gas for industry use)



■ Soldering Iron

■ Hot Blow

■ Torch

■ Specifications

System		Gas Catalyst Reaction System Pressure Gas Burning System (Torch)
Thermal Output	Soldering Iron	200°C~500°C (Equivalent to 20~60W electric soldering iron)
	Hot Blow	650°C MAX
	Torch	1300°C MAX
Gas Container Capa.		12ml
Operation Time for One Gas Fill		about 60 min. (Lever position: Middle)
O.A.Length		197mm Cap Included
Weight		74g

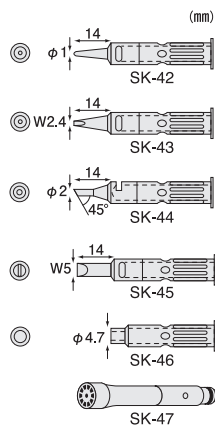

Item No.	Description
SK-42	Tapered Needle
SK-43	Chisel
SK-44	φ2mm Spade
SK-45	Chisel
SK-46	Hot blow tip
SK-47	Ejector Unit



265ml



480ml

SS-15 2P-3P PLUG CONVERTER

- Converts 3P Plug with ground wire into 2P.

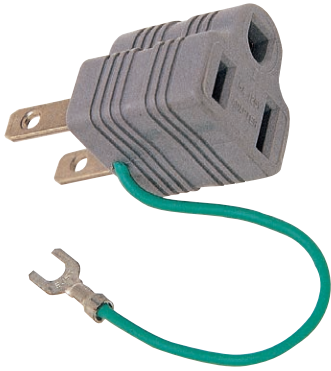
**ZC-70·71****FLUX/DISPENSER**

Ideal for rework of SMD solders.

- Pin-point accuracy with no spillage

ZC-70

- FLUX 50cc
- FLUX DISPENSER
- NEEDLE (Hole diam. 0.25/0.5mm) 1pce. each
- CLEANING PIN 1pce. each

ZC-71

- FLUX DISPENSER (BOTTLE)
- NEEDLE (Hole diam. 0.25/0.5mm) 1pce. each
- CLEANING PIN 1pce. each

**SD-20(SD-21~26·SD-60~88)**

High-capacity ceramic heater and powerful motor, capable of suction and hot air blow.

- Built-in motor, diaphragm type vacuum pump, temperature adjustable circuit and indicator light.
- Low noise and low vibration due to floating mechanism.
- Minimum reaching time to the maximum vacuum and powerful suction capacity.
- Ideal for desoldering on 4-8 layered PCB's.
- No static damage to IC etc. due to carboniferous body.

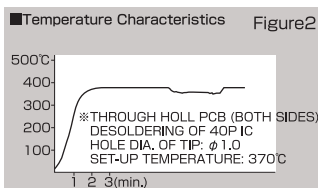
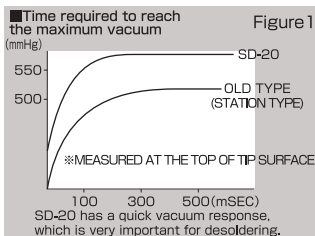
**REPLACEMENT PARTS**

Item No.	DESCRIPTION
SD-61	TIP φ0.8
SD-62	TIP φ 1.0
SD-63	TIP φ 1.5
SD-87	TAPERING SLIM TIP φ 0.8
SD-88	TAPERING SLIM TIP φ 1.0
SD-21	HEATER HOLER
SD-22	HEATER ASSY
SD-23	PIPE SETTER
SD-24	FILTER CARTRIDGE (5pcs.)
SD-25	SEAT VALVE
SD-26	DIAPHRAGM

Contents

- Carrying case
- Desoldering tool
- Spare tip (φ 1.5)
- Spare filter cartridge (2pcs.)
- Cleaning pin

SPECIFICATIONS

POWER SOURCE	AC100V · 50/60Hz
PUMP	DIAPHRAGM TYPE
MOTOR OUTPUT	12W
VACUUM ATTAINED	650mmHg
TIME REQUIRED TO REACH MAXIMUM VACUUM	0.2 seconds
AIR FLOW RATE (OPEN)	15 liter/min.
HEATER	100W(Ceramic)
CONTROL SYSTEM	Feed back zero cross over type
TEMPERATURE RANGE	350~500°C
TIP (HOLE DIA.)	1.0φ (STANDARD)
POWER SUPPLY CORD	3P CORD (W GROUND) 1.8m
WEIGHT	420g(excluding cord)

TOOL STAND

SD-60

**DESOLDERING TOOL**

DESTINATIONS ARE LIMITED FOR EXPORT

INDICATOR LIGHT

When the heater is on, light goes on and when the temperature reaches set-up level, it flickers.

Temperature Adjustment Dial (350~500°C)

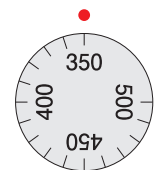
**SD-30(SD-29·31·86)****SMD ACCESSORY KIT**

- For easy removal of SMD components including QFP & SOP owing to Hot Blow function of SD-20

Contents:

- SD-29 Filter Pipe
- SD-31 Stainless Wire Reel
- SD-86 Hot Air Nozzle



SD-86

SD-29

SD-31

SS-20

IRON STAND

- Heat resistance engineering plastic on iron holder for cutting heat conduction to iron's grip
- Holds any soldering iron up to 13mm diam.
- 700g massive base stand creates high stability on bench.
- Dimensions:80Wx140Hx90D (mm)

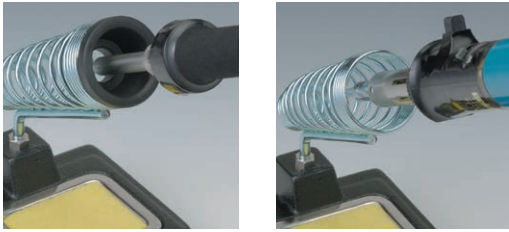

■ Ring detachable

SS-05

TIP CLEANER

- Glass-filled nylon resin (Housing) featuring heat resistance of 130°C
- O-ring creates airtight condition to keep sponge moist.
- Comes with 2 pcs. of cleaning sponges of different densities (blue & yellow)
- Easy to open the lid owing to sliding-lock structure
- Weight: 75g

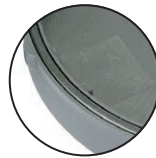

■ O-ring in lid

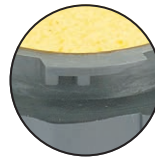

■ Sliding lock

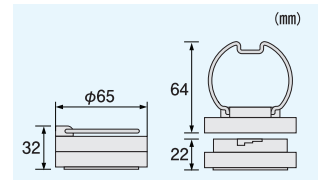

SS-01·02

SOLDER SUCKER

- All aluminum construction, well designed to suck up melted solder easily and efficiently with one-hand plunger action.
- Self-cleaning shaft allows high productivity of continual work without clogging.

SS-01

- Teflon tip : $\phi 2.2\text{mm}$ (Int.)
- Ideal for desoldering work at dense spot on PCB
- Body : $\phi 14 \times 170\text{mm}$



SS-02

- Silicone nozzle : $\phi 2\text{mm}$ (Int.) $\phi 4\text{mm}$ (Ext.)
- High-power and efficient absorption by means of elastic nozzle contact
- Low maintenance cost owing to spare tube only required for replacement
- 2 pcs. of spare silicone tubes (50mm long) originally included
- Body : $\phi 20 \times 153\text{mm}$



Heat resistant (350°C) silicone nozzle

Compact and durable aluminum body

Item No.	Cylinder Capa.	Wgt.
SS-01	5 ml	33g
SS-02	9 ml	52g

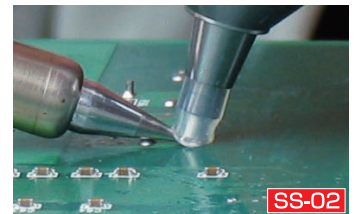

Elastic and heat-resistant nozzle can stick to soldering iron on board closely and suck up solder powerfully with less residue.



Plunger is within easy reach of thumb. It is ideal for one-hand operation in continuous work.

SS-11

REPLACEMENT NOZZLE FOR SS-01

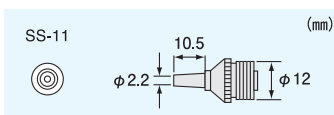

SS-16

REPLACEMENT SILICONE TUBES

- $\phi 2 \times 50\text{mm}$ 2 pcs./set
- Cut desired length of tube freely.
- Use only for SS-02



SCREW REMOVAL

SCISSORS

NIPPERS

PLIERS

CRIMPING STRIPPING

TWEEZERS

SCREW DRIVERS

SPECIAL DRIVERS

WRENCHES

CUTTING PROCESSING

SETS CASES

SOLDERING EQUIPMENT

ESD CHEMICALS

SWS-06~12 SUPERIOT RMA SOLDER

No cleaning high performance resin core solder, highest grade flux construction

- Completely non-corrosive flux residue which requires no cleaning after soldering
- Everlasting and reliable bonding owing to non-conductive and non-absorbable residue
- Wide solder spread and wetting for speedy work
- Contains organic amine activated rosin to meet highest JIS grade & MIL-RMA.



SWA-06~12 SUPERIOT RA SOLDER

No cleaning high performance resin core solder for soldering stainless steel

- Non-corrosive flux residue featuring everlasting bonding
- Featuring stable bonding owing to non-conductive and non-absorbable residue
- Continuous and high performance activation makes it possible to solder stainless steel.
- Contains organic amine activated rosin to meet JIS standard.



■ Superiot RMA / For use on precision PCB of copper and its alloy

Item No.	Tin/Lead Ratio, Melting point	Flux(Wt%)	Soluble resistance $\Omega \cdot \text{cm}$	Insulation resistance Ω	Wire diam. (mm)	Wire length. (m)
SWS-06	Sn60/Pb40 183~190°C	1.7% Noncleaning flux	1×10^5	3×10^{13} (Normal temp.)	0.6	5.6
SWS-08					0.8	4.4
SWS-10					1.0	5.5
SWS-12					1.2	4.6

■ Superiot RA / For use on stainless steel & nickel

Item No.	Tin/Lead Ratio, Melting point	Flux(Wt%)	Soluble resistance $\Omega \cdot \text{cm}$	Insulation resistance Ω	Wire diam. (mm)	Wire length. (m)
SWA-06	Sn60/Pb40 183~190°C	2.7% Noncleaning flux	6×10^4	2×10^{13} (Normal temp.)	0.6	5.6
SWA-08					0.8	4.4
SWA-10					1.0	5.5
SWA-12					1.2	4.6

SWS-56~82 SUPERIOT RMA SOLDER



Item No.	Wire diam. (mm)	Weight (g)
SWS-56	0.6	500
SWS-58	0.8	
SWS-60	1.0	
SWS-62	1.2	1000
SWS-76	0.6	
SWS-78	0.8	
SWS-80	1.0	
SWS-82	1.2	

SWA-56~82 SUPERIOT RA SOLDER



Item No.	Wire diam. (mm)	Weight (g)
SWA-56	0.6	500
SWA-58	0.8	
SWA-60	1.0	
SWA-62	1.2	1000
SWA-76	0.6	
SWA-78	0.8	
SWA-80	1.0	
SWA-82	1.2	

SWU-02~06

SOLDER WICK

- SODER-WICK® Highest copper braid features fast absorption of solder.
- No cleaning process required and leaving less residue of flux on circuit board



For desoldering highly dense SMD

SWU-02 1.5mm×1.5m



For desoldering small electronic parts or plated through hole

SWU-03 1.9mm×1.5m



For desoldering medium electronic parts or solder bridges

SWU-04 2.8mm×1.5m



For desoldering large-sized parts or terminals

SWU-05 3.9mm×1.5m



For use at large solder lugs

SWU-06 5.6mm×1.5m

SW-11~53

SOLDER

- High quality solder wire for precision electronic components.
- No paste is necessary because of activated rosin.



Item No.	diam.(mm)	Weight(g)
SW-11	0.6	150
SW-12		500
SW-13		1000
SW-21	0.8	150
SW-22		500
SW-23		1000
SW-30	1.0	20
SW-31		150
SW-32		500
SW-33		1000
SW-41	1.2	150
SW-42		500
SW-43		1000
SW-51	1.6	150
SW-52		500
SW-53		1000

SD-10

DIGITAL MULTIMETER

Multifunctional and compact : The ultimate tool for all your measurements!

- 3999 Counts, Auto-ranging
- Magnetic attachment to a metallic surface
- Gold-plated test leads for corrosion-resistance

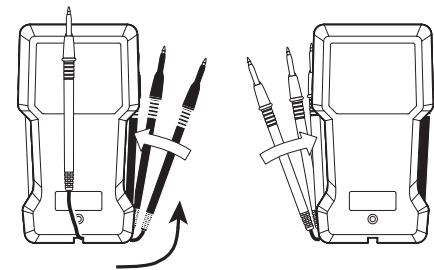

Test leads can be stored conveniently.



Operating principle	Dual integration
Display	LCD, 3999 Counts
Range switch	Auto range
Auto power off	Approx. 30 minutes (can be disabled)
Sampling	3 times / sec.
Operating temperature	0°C to 40°C less than 80% RH (without condensation)
Storage temperature	-10°C to 60°C less than 70% RH (without condensation)
Power	CR2032(3V) lithium battery x 1
Battery life	Approx. 120 hours
Dimensions and weight	70(W) x 127(H) x 12.5(D)mm Approx. 101g (incl. battery)
Lead length	Approx. 70cm
Standard	IEC61010-1 CAT II 600V, CAT III 300V
Accessories	Operation manual, Soft case

Function	Range	Resolution	Accuracy
DCV	4V	0.001V	±(1.0%+3dgt)
	40V	0.01V	
	400V	0.1V	
	600V	1V	
ACV	4V	0.001V	±(2.0%+5dgt)
	40V	0.01V	
	400V	0.1V	
	600V	1V	
Resistance	400Ω	0.1Ω	±(2.0%+5dgt)
	4kΩ	0.001kΩ	
	40kΩ	0.01kΩ	
	400kΩ	0.1kΩ	
	4MΩ	0.001MΩ	
Frequency	40MΩ	0.01MΩ	±(0.5%+5dgt)
	5Hz	0.001Hz	
	50Hz	0.01Hz	
	500Hz	0.1Hz	
	5kHz	0.001kHz	
	50kHz	0.01kHz	
Capacitance	100kHz	0.1kHz	±(5.0%+5dgt)
	50nF	0.01nF	
	500nF	0.1nF	
	5uF	0.001uF	
	50uF	0.01uF	
	100uF	0.1uF	

※Accuracy assurance of ACV·Frequency is limited to sine wave.

SCREW REMOVAL

SCISSORS

NIPPERS

PLIERS

CRIMPING STRIPPING

TWEEZERS

SCREW DRIVERS

SPECIAL DRIVERS

WRENCHES

CUTTING PROCESSING

SETS CASES

SOLDERING EQUIPMENT

ESD CHEMICALS

SL-50~53

POCKET LOUPE

- SL-50**
 ● 10x/20mm diam.
 ● 83mm length
 ● 50mm (case)

- SL-51**
 ● 8x/25mm dia.&
 15x/13mm dia.
 ● 150mm length
 ● 84mm (case)

- SL-52**
 ● Combination of 3x, 4x & 5x lens for max. 10x magnification
 ● 19mm diam. lens
 ● 83mm length
 ● 50mm (case)

- SL-53**
 ● Sharp and very distinct images with no color distortion
 ● Ideal for jewelry appraisal
 ● 18x/17mm diam.
 ● 63mm length
 ● 40mm (case)



SL-55~57

INSPECTION LOUPE

- Focus adjustment by sliding lens sleeve
- Built-in scale (detachable)

SL-55



- 10x
- 10mm diam. view
- Scale L

SL-56



- 15x
- 6mm diam. view
- Scale S

SL-57



- 22x
- 4mm diam. view
- Scale S

SL-12



- x10 Glass Lens
- Lens diameter : 30mm
- Crosshairs 0.1mm x 240
- Ext. Size : dia.38 x 50(H)
- with carrying pouch



BUILT-IN SCALE

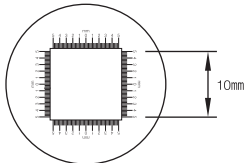

L: 0.2mm/scale

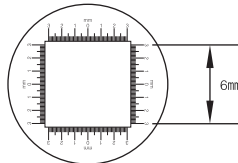

S: 0.1mm/scale

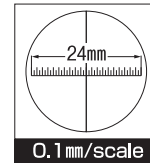

0.1mm/scale

Item No.	SL-50	SL-51	SL-52	SL-53	SL-12	SL-55	SL-56	SL-57
Magnification	x10	x8 & x15	x3, 4 & 5	x18	x10	x10	x15	x22
Lens Material	Glass	Glass	White Glass	White Glass	White Glass	White Glass	White Glass	White Glass
Lens Structure	1+1	1+1	single	5-fold	1+1	1+1	1+1	1+1

※ 1+1 Structure : 1 pce. of eyepiece and 1 pce. of objective lens
 ※ 1+2 Structure : Achromatic Lens - combination of different refractive lens minimizes chromatic aberration.
 ※ 5-fold lens : superior to achromatic lens in aspect of no aberration and creates clearer image.

SL-64

FOLDABLE MAGNIFIER

- x 3.5 Magnification acrylic lens
- Lens diameter: 40mm
- Foldable arm, flexible design
- Magnet attachment
- with carrying case



Portable magnifier



Attachment to a crimp tool



Self-standing for handsfree



Collapsible to fit carrying case



SL-01~03·11

iRoHS INSPECTION MIRROR

SL-01

- 35mm diam. angle-adjustable mirror
- O.A. length: 245mm



SL-02

- 35mm diam. adjustable all-angle ball joint mirror with pocket clip
- Telescopic rod extends from 192 to 540mm in length



SL-11

- Anti-magnetic stainless steel (AISI304) frame ideal for work on electronic parts and devices
- 21mm diam. adjustable all-angle ball joint magnifying mirror
- 2-sectioned telescopic rod (Min. 150mm - Max. 215mm)
- Compact body and thin head (frame) for inspection even at a narrow space

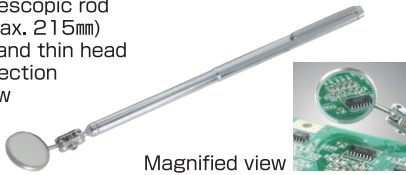

Magnified view

SL-03

- 35mm diam. adjustable all-angle ball joint magnifying mirror (Concave)
- Telescopic rod extends from 265 to 740mm in length



with built-in magnet

SL-04·07

iRoHS DESK-TOP LOUPE

SL-07

- x 2.5 ϕ 90mm lens
- 175mm Flexible shaft allows easy positioning.



SL-04

- Magnifying power: 2.5x/75mm diam. lens.
- Ball joint permits free change of angles and positions.



SL-22

LED LIGHT LOUPE

- 2x/95mm diam. Acrylic lens with x4 bifocal lens built-in
- Long-life and bright LED (16 bulbs)
- DC power (AA battery x 4 pcs.)
※ Battery is not included.
- AC adapter (Input voltage 100-240V) included
- Magnet base stand for handsfree work
- 310mm Flexible arm for easy positioning
- Desk clamp (Max. opening 65mm. Depth 58mm)



LED (16bulbs)

 ϕ 25mm (x4) ϕ 95mm (x2)

Flexible arm

Magnet base

SL-23

iRoHS LED STAND LOUPE



Built-in LED

 ϕ 22mm (x5) ϕ 105mm (x2)

Flexible arm

- 2x/105mm diam. Acrylic lens with x5 bifocal lens built-in
- Illuminated by 2 LED's, ideal for inspection and hobby use
- DC power (AA battery x 3 pcs.)
※ Battery is not included.
- 300mm Flexible arm for easy positioning

SL-71

FLASHLIGHT LOUPE

- Light beam illuminates magnified area.
- 10X, 30mm diam.
- 2 x C-cell battery adapted
- O.A. length: 177mm



Built-in 20mm scale

SL-72

iRoHS UTILITY LOUPE

- 3X 65mm diam. lens consists of aberration-free white lens.
- Versatile use with chrome-plated frame and wooden shaft.
- O.A. length: 175mm



SL-80~83/85~88

iRoHS HEAD LOUPE

- Suitable for inspection/repair of electronic and precise instruments
- Well-fitted head band with velcro tape
- Usable even while wearing glasses.

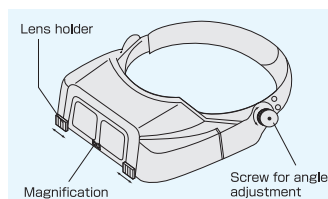

Lens holder

Magnification

Screw for angle adjustment



Head loupe

Item No.	Magnification
SL-80	1.8
SL-81	2.3
SL-82	2.7
SL-83	3.5

Replacement lens

Item No.	Magnification
SL-85	1.8
SL-86	2.3
SL-87	2.7
SL-88	3.5

● The size of all the replacement lens is common and suitable for any head loupes.

ESD Products and Chemicals



ZC-01·02

RoHS CONDUCTIVE FOAM

- Conductive urethane foam with high density in 10mm thickness.
- Protects CMOS IC and other static-sensitive components during storage, in transit and in hand.
- Material: Polyethylene

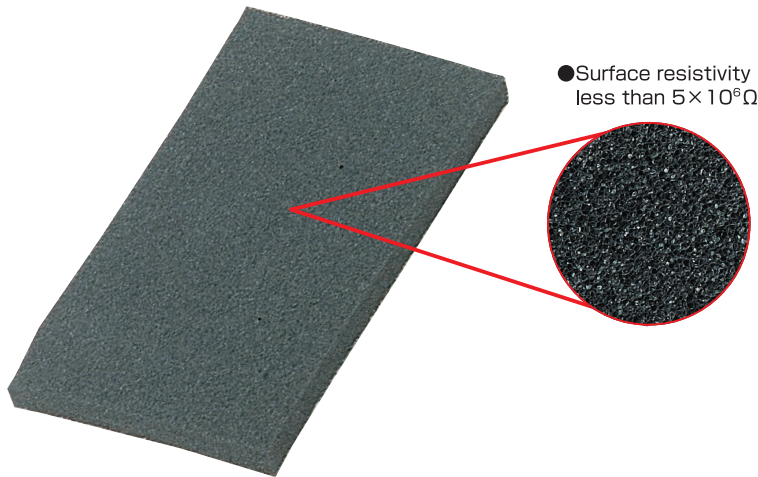

● Surface resistivity less than $5 \times 10^9 \Omega$

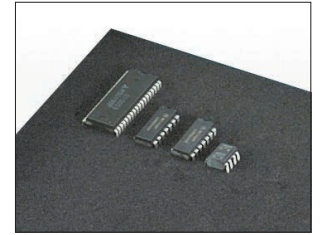

Item No.	Size(mm)
ZC-01	075×130×10
ZC-02	100×290×10

ZC-50

RoHS WRIST STRAP

- Conveniently-designed earth cord to improve precise work efficiently
- Curving-shaped & wide plastic body (30x20mm) featuring higher conductivity around wrist
- Silver filaments in elastic band ideal for high conductivity & anti-metallic allergy



Applications

Assembly or repair of electronics and precise instrument for anti-static electricity

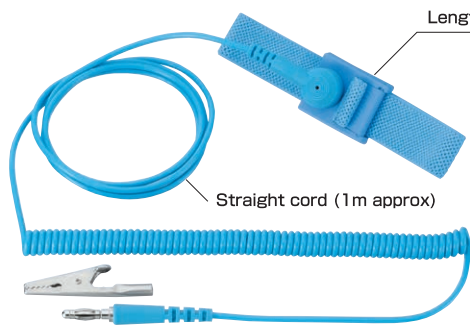

Length adjustable

Straight cord (1m approx)

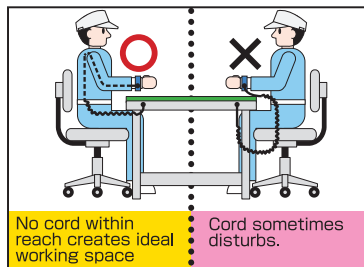

No cord within reach creates ideal working space

Cord sometimes disturbs.



Specifications :

- Adjustable type wrist band
- Built-in 1MΩ resistor for safety
- Alligator clip included
- Polyester elastic band woven with silver filaments

If anyone who is charged with static electricity through clothes touches IC's and electronic components, he discharges electricity through his fingers and gives a damage to IC's and electronic components. Wrist Strap can eliminate static electricity through his wrist to prevent them from being damaged.

ZC-80

RoHS ANTI-STATIC SERVICE KIT

- Mat size : 900×600mm (Thickness 0.7mm)
- Contents : Wrist strap with cord (1MΩ)
Spare earth cord (1MΩ)
Zippered carrying case (270×200mm)

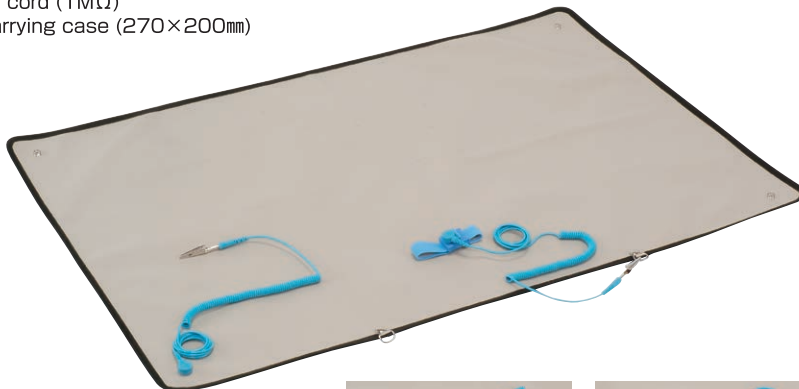

Rayon backing with stud



Earth cord

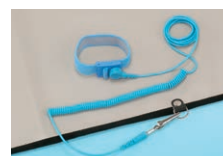

Wrist strap



Layer	Color	Material	Thickness	Surface Resistivity
Top	Beige	PVC	0.35mm	$7.3 \times 10^9 \Omega$
Bottom	Gray	Rayon	0.3mm	$1.5 \times 10^9 \Omega$

SCREW REMOVAL

SCISSORS

NIPPERS

PLIERS

CRIMPING STRIPPING

TWEEZERS

SCREW DRIVERS

SPECIAL DRIVERS

WRENCHES

CUTTING PROCESSING

SETS CASES

SOLDERING EQUIPMENT

ESD CHEMICALS

ZC-44~49  **STATIC CONDUCTIVE GLOVES**

- Surface resistivity : $10^5 \sim 10^6 \Omega$ sq.(Finger) $10^7 \Omega$ sq.(Palm)
- Ideal for clean room, assembly of electronic devices, handling of plastic products, etc.
- Copper sulfide mixed with acryl/nylon creates an excellent conductive effect (Finger Part)
- Seamless and dust-free mono-filament
- Chemical dyeing of conductive element features less reduction of conductivity withstanding repeated washing
- Material : Fabric - Nylon 90% Acryl 10%
: Coating - Polyurethane Resin



ZC-51~56  **ANTI-STATIC GLOVES**

- Surface resistivity : $10^6 \sim 10^9 \Omega$ sq.
- Ideal for any work in the facility where anti-static should be controlled
- Seamless and dust-free mono-filament
- Washable with ordinary detergent
- Material : Fabric - Nylon 75% Acryl 25%
: Coating - Polyurethane Resin



■Fingertip Coating (mm)

Item No.	Size	A×B
ZC-44	S	72×185
ZC-45	M	83×190
ZC-46	L	85×200

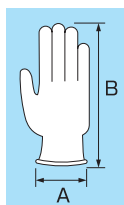

■Palm Coating (mm)

Item No.	Size	A×B
ZC-47	S	80×210
ZC-48	M	85×220
ZC-49	L	90×230

■Fingertip Coating (mm)

Item No.	Size	A×B
ZC-51	S	75×190
ZC-52	M	88×200
ZC-53	L	89×215

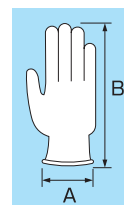

■Palm Coating (mm)

Item No.	Size	A×B
ZC-54	S	77×210
ZC-55	M	90×220
ZC-56	L	95×230

ZC-38~43  **DUST-FREE GLOVES**

- Flexible & comfortable gloves made of elastic and breathable nylon fiber
- Ideal for use in clean room and handling of C.R.T., electric bulb, compact disc, glass, etc.
- Seamless and dust-free mono-filament
- Non-slip coating for accurate assembly work
- Washable with ordinary detergent
- Material : Fabric - Wooly Nylon
: Coating - Polyurethane Resin

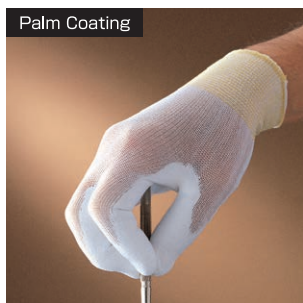
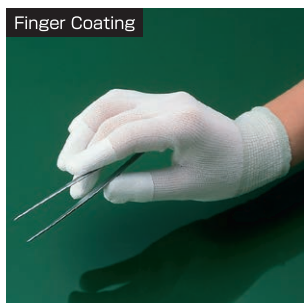

■Fingertip Coating (mm)

Item No.	Size	A×B
ZC-38	S	77×185
ZC-39	M	90×190
ZC-40	L	90×200

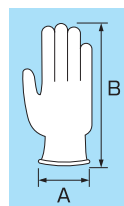

■Palm Coating (mm)

Item No.	Size	A×B
ZC-41	S	80×210
ZC-42	M	90×220
ZC-43	L	95×230

ZC-82·84·86  **STATIC CONDUCTIVE BAG**

- Surface resistivity : $10^4 \Omega$ or less
- Color : Black
- Thickness : 0.05mm
- Material : Polyethylene (Carbon contained)



Item No.	Size(mm)	Package
ZC-82	100×150	100pcs.
ZC-84	200×300	100pcs.
ZC-86	300×450	100pcs.

ZC-92·94·96  **ANTI-STATIC BAG**

- Surface resistivity : $10^{11} \Omega$ or less
- Color : Blue Transparent
- Thickness : 0.05mm
- Material : Polyethylene

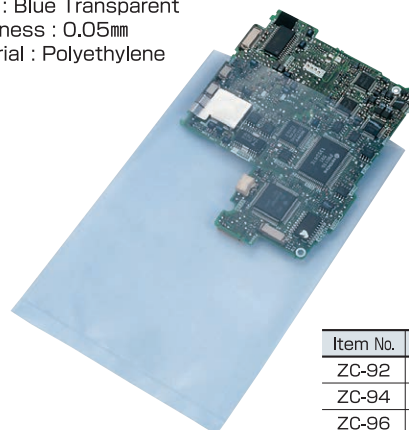

Item No.	Size(mm)	Package
ZC-92	100×150	100pcs.
ZC-94	200×300	100pcs.
ZC-96	300×450	100pcs.

ZCM-01~04**RoHS CONDUCTIVE COLORED MAT**

- Static-Dissipative mat maintains an ESD-Safe working surface.
- Anti-Fatigue rubber material that provides cushioning comfort.
- Available in pre-cut mats or rolls.

**Usage**

Put ZC-62 on the reverse of the mat for grounding.
Use ZC-63 in connection of mat.

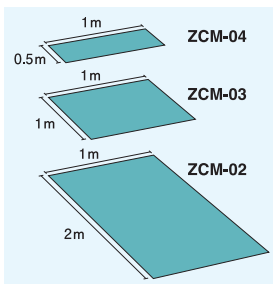
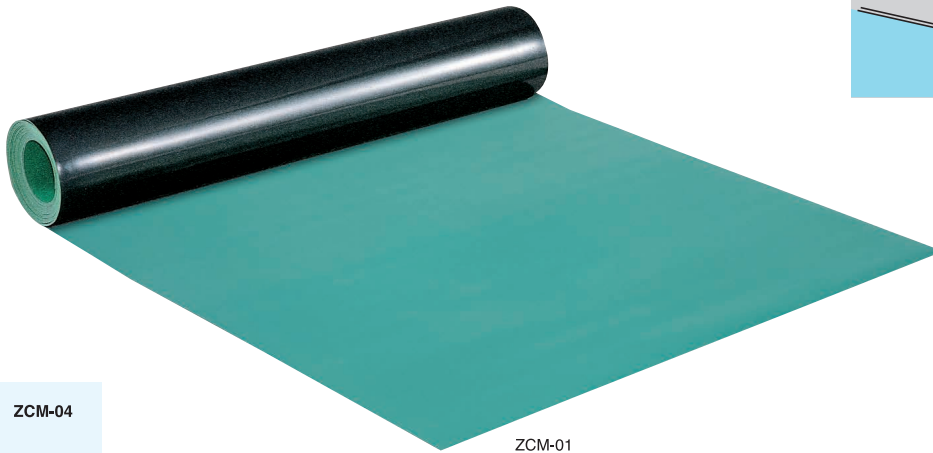
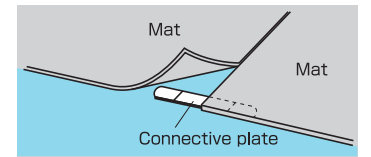

- Surface resistivity
Top Layer (Green) : $10^8 \sim 10^{10} \Omega$
Bottom Layer (Black) : $10^3 \sim 10^5 \Omega$

Item No.	Size
ZCM-01	1m×10m×2mm
ZCM-02	1m×2m×2mm
ZCM-03	1m×1m×2mm
ZCM-04	1m×0.5m×2mm

ZC-62**RoHS GROUND CORD**

- For ZCM-01~04
- Size : Cord.....2m Plate...15cm×2cm

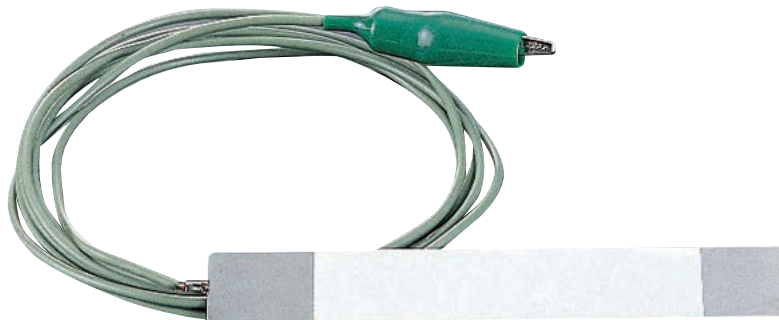
**ZC-63****RoHS CONNECTIVE PLATE**

- For ZCM-01~04
- Contents : 10pcs.
- Size : 15cm×2cm

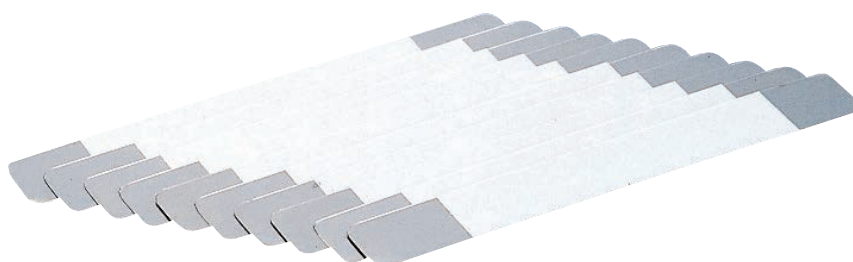
SCREW
REMOVAL

SCISSORS

NIPPERS

PLIERS

CRIMPING
STRIPPING

TWEEZERS

SCREW
DRIVERSSPECIAL
DRIVERS

WRENCHES

CUTTING
PROCESSINGSETS
CASESSOLDERING
EQUIPMENTESD
CHEMICALS

ZC-28

RUST REMOVER

Amazing - How quickly it cleans rust off!

- Since it is a neutral liquid, you can work safely (it does not contain acid or alkali).
- Rust on small components, such as rusted screws, can be removed in seconds.
- No need to scrub.

How it works on rusty screws

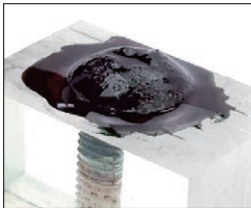

1. Penetration

The liquid penetrates through small gaps and reaches the screw's thread in seconds!



2. Rapid Action

It instantly reacts on the rust and turns purple!



3. Screw Removal

Utilize Screw Removal Pliers to loosen the treated screw with sure-gripping jaws.



SAFE: Neutral liquid
Less harmful to bare skin
(unlike acid or alkali)



Before



After

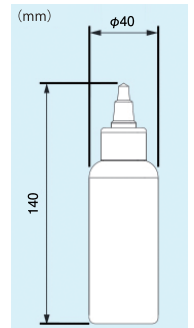

PRODUCT VIDEO



Before
After

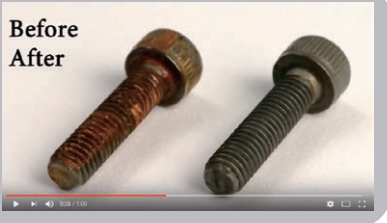

Item No.	pH	Capacity	Bottle size
ZC-28	Neutral	100ml	φ40 x H140mm

ZC-19

ROHS OILER

- Compact-sized and handy oiler
- Nozzle extendable (60mm-long approx.) for oiling at hard-to-reach area
- Capacity: 20ml
- Material: PE (Bottle/Cap), Brass (Nozzle)
- Usage: Oil, Water, Cleaning fluid, etc.

How to use

- ① Extend nozzle upward.
 - ② Unscrew plastic cap.
 - ③ Remove packing inside.
 - ④ Pour oil in bottle.
 - ⑤ Fasten the packing and the cap with nozzle in order.
- ※ Keep the bottle upright in storage.



Machinery maintenance



Lubrication

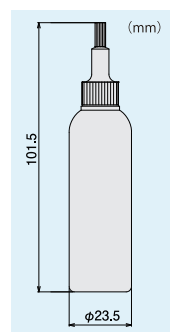

D

ITEM No.	CODE No.	ITEM	PAGE
DA-01	1001	Alignment Screwdriver	49
DA-02	1002	Alignment Screwdriver	49
DA-03	Discon.	Alignment Screwdriver	X
DA-40	1040	Alignment Screwdriver	49
DA-48	1048	Ceramic Alignment Screwdriver	48
DA-50	1050	Ceramic Alignment Screwdriver	48
DA-51	1051	Ceramic Alignment Screwdriver	48
DA-52	1052	Ceramic Alignment Screwdriver	48
DA-53	1053	Ceramic Alignment Screwdriver	48
DA-54	1054	Ceramic Alignment Screwdriver	48
DA-55	1055	Ceramic Alignment Screwdriver	48
DA-56	1056	Ceramic Alignment Screwdriver	48
DA-57	1057	Ceramic Alignment Screwdriver	48
DA-58	1058	Ceramic Alignment Screwdriver	48
DA-59	1059	Ceramic Alignment Screwdriver	48
DA-72	1072	Ceramic Alignment Screwdriver	48
DA-73	1073	Ceramic Alignment Screwdriver	48
DA-74	1074	Ceramic Alignment Screwdriver	48
DA-75	1075	Ceramic Alignment Screwdriver	48
DA-76	1076	Ceramic Alignment Screwdriver	48
DA-77	1077	Ceramic Alignment Screwdriver	48
DA-78	1078	Ceramic Alignment Screwdriver	48
DA-79	1079	Ceramic Alignment Screwdriver	48
DA-81	1081	Ceramic Alignment Screwdriver	49
DA-82	1082	Ceramic Alignment Screwdriver	49
DA-83	1083	Ceramic Alignment Screwdriver	49
DA-84	1084	Ceramic Alignment Screwdriver	49
DA-85	1085	Ceramic Alignment Screwdriver	49
DA-86	1086	Ceramic Alignment Screwdriver	49
DA-87	1087	Ceramic Alignment Screwdriver	49
DA-88	1088	Ceramic Alignment Screwdriver	49
DAP-01	0601	Pentalobe Driver	43
DAT-02	0602	Hex-Lobe Driver	43
DB-15	1315	Ball Point Driver	45
DB-20	1320	Ball Point Driver	45
DB-25	1325	Ball Point Driver	45
DB-30	1330	Ball Point Driver	45
DB-40	1340	Ball Point Driver	45
DB-50	Discon.	Ball Point Driver	X
DBZ-50B	1448	Handle Grip for DBZ	8
DBZ-51	1451	Replacement Bit for DBZ-60G	9
DBZ-52	1452	Replacement Bit for DBZ-60G	9
DBZ-53	1453	Optional Bit for DBZ-60G	9
DBZ-54	1465	Optional Bit for DBZ-60G	9
DBZ-56	1466	Optional Bit for DBZ-60G	9
DBZ-57	1467	Optional Bit for DBZ-60G	9
DBZ-60G	1462	Rapid Screw Extractor	8
DBZ-62	1471	Optional Bit for DBZ-60G	9
DBZ-63	1472	Optional Bit for DBZ-60G	9
DBZ-64	1473	Optional Bit for DBZ-60G	9
DBZ-65	1474	Optional Bit for DBZ-60G	9
DG-01	1101	Pro Grip Driver	38
DG-02	1102	Pro Grip Driver	38
DG-03	1103	Pro Grip Driver	38
DG-04	1104	Pro Grip Driver	38
DG-05	1105	Cushion Driver	38
DG-08	1108	Master Grip Driver	38
DG-09	1109	Master Grip Driver	38
DG-11	1111	Extra Long Grip Driver	38
DG-12	1112	Extra Long Grip Driver	38
DG-13	1113	Extra Long Grip Driver	38
DG-14	1114	Extra Long Grip Driver	38
DG-21	1121	Mini Soft Driver	39
DG-22	1122	Mini Soft Driver	39
DG-23	1123	Mini Soft Driver	39
DG-24	1124	Mini Soft Driver	39
DH-15	1515	Hex Driver	45
DH-20	1520	Hex Driver	45
DH-25	1525	Hex Driver	45
DH-30	1530	Hex Driver	45
DH-40	1540	Hex Driver	45
DH-50	1550	Hex Driver	45
DH-60	Discon.	Hex Driver	X
DJ-01	Discon.	Plug Jack Driver	X
DJ-02	Discon.	Plug Jack Driver	X
DJ-03	1763	Plug Jack Driver	44
DJ-04	1764	Plug Jack Driver	44
DJ-05	Discon.	Plug Jack Driver	X
DK-01	1601	Hex Driver Set	46
DK-02	1602	Hex Driver Set	46
DK-03	1603	Ball Point Driver Set	46
DK-04	1604	Nut Driver Set	46
DK-05	1605	Interchangeable Driver Set	47
DK-05P		Interchangeable Driver Set	47
DK-06	1606	Interchangeable Driver Set	47
DK-06P		Interchangeable Driver Set	47

DK-07	Discon.	Interchangeable Driver Set	X
DK-08	1608	Interchangeable Driver Set	47
DK-10	Discon.	⊕⊖Precision Driver Set	X
DK-13	1613	Reversible Precision Dr. Set	45
DK-14	1614	Nut Driver Set	46
DK-16	1616	Mini Soft Driver Set	39
DK-20	Discon.	⊕Precision Driver Set	X
DK-21	Discon.	Precision Driver	X
DK-22	Discon.	Precision Driver	X
DK-23	Discon.	Precision Driver	X
DK-24	Discon.	Precision Driver	X
DK-25	Discon.	Precision Driver	X
DK-26	Discon.	Precision Driver	X
DK-30	Discon.	⊖Precision Driver Set	X
DK-31	Discon.	Precision Driver	X
DK-32	Discon.	Precision Driver	X
DK-33	Discon.	Precision Driver	X
DK-34	Discon.	Precision Driver	X
DK-35	Discon.	Precision Driver	X
DK-36	Discon.	Precision Driver	X
DK-50	1650	Reversible Driver Set	39
DK-51	1651	Reversible Driver	39
DK-52	1652	Reversible Driver	39
DK-53	1653	Reversible Driver	39
DK-60	Discon.	⊕⊖Precision Driver Set	X
DK-80	Discon.	Computer Driver Set	X
DK-81	Discon.	Mobile Phone Driver Set	X
DK-82	Discon.	Mobile Phone Driver Set	X
DK-90	1690	Ceramic Alignment Driver Set	48
DK-91	1691	Ceramic Alignment Driver Set	49
DKD-01	1781	Circuit Testing Driver	45
DKD-02	Discon.	Circuit Testing Driver	X
DKD-03	1783	Led Circuit Tester	45
DM-20	1180	⊕Precision Driver Set	47
DM-21	1181	⊕Precision Driver	47
DM-22	1182	⊕Precision Driver	47
DM-23	1183	⊕Precision Driver	47
DM-24	1184	⊕Precision Driver	47
DM-25	1185	⊕Precision Driver	47
DM-26	1186	⊕Precision Driver	47
DM-30	1190	⊖Precision Driver Set	47
DM-31	1191	⊖Precision Driver	47
DM-32	1192	⊖Precision Driver	47
DM-33	1193	⊖Precision Driver	47
DM-34	1194	⊖Precision Driver	47
DM-35	1195	⊖Precision Driver	47
DM-36	1196	⊖Precision Driver	47
DM-60	1200	⊕⊖Precision Driver Set	47
DN-01	1701	Nut Driver	44
DN-02	1702	Nut Driver	44
DN-03	1703	Nut Driver	44
DN-04	1704	Nut Driver	44
DN-05	1705	Nut Driver	44
DN-06	1706	Nut Driver	44
DN-07	1707	Nut Driver	44
DN-08	1708	Nut Driver	44
DN-09	1709	Nut Driver	44
DN-10	1710	Nut Driver	44
DN-12	1712	Nut Driver	44
DNC-55T	0455	Nut Catching Driver	44
DNC-57T	0470	Nut Catching Driver	44
DNC-65T	0465	Nut Catching Driver	44
DNP-05	Discon.	Pro Nut Driver	X
DNP-07	Discon.	Pro Nut Driver	X
DNP-08	Discon.	Pro Nut Driver	X
DNP-10	Discon.	Pro Nut Driver	X
DP-03	1803	Pro-Use Driver⊕	38
DP-13	1813	Pro-Use Driver⊖	38
DP-24	1824	Pro-Use Driver⊕	38
DP-34	1834	Pro-Use Driver⊕	38
DP-44	1844	Pro-Use Driver⊖	38
DP-54	1854	Pro-Use Driver⊖	38
DP-64	1864	Pro-Use Driver⊕	38
DR-03	1203	Ratchet Stubby Driver	40
DR-04	1204	Ratchet Stubby Driver Set	40
DR-05	1205	Offset Ratchet Driver	40
DR-06	1206	Offset Ratchet Driver with Bit Set	40
DR-07	1207	Twin Wrench Driver Set	40
DR-08	1208	Ratchet Stubby Driver Set(Flex.)	40
DR-10	1210	Bit Set	41
DR-11	1211	Bit Set	41
DR-14	Discon.	Bit Set	X
DR-15	1215	Bit Set	41
DR-16	1216	Bit Set	41
DR-17	1217	Bit Set	41
DR-18	1218	Bit Set for Mobile Phone	43
DR-50	1250	Twin Wrench Driver Set	43
DR-51	1251	Master Grip Driver for Hex-Lobe Screw	44
DR-52	1252	Master Grip Driver	40
DR-53	Discon.	Cushioned Grip Ratchet Driver	X
DR-54	1255	Stubby Ratchet Driver	39

DR-55	1255	Mini Offset Ratchet	41
DR-56	1256	7-in-1 Angled Ratchet	41
DS-03	1903	Standard Driver⊕	38
DS-12	1912	Standard Driver⊖	38
DS-13	1913	Standard Driver⊖	38
DS-14	1914	Standard Driver⊖	38
DS-16	Discon.	Standard Driver⊖	X
DS-23	1923	Standard Driver⊕	38
DS-24	1924	Standard Driver⊕	38
DS-33	1933	Standard Driver⊖	38
DS-34	1934	Standard Driver⊖	38
DS-44	1944	Standard Driver⊕	38
DS-46	1946	Standard Driver⊕	38
DS-54	1954	Standard Driver⊖	38
DS-64	1964	Standard Driver⊕	38
DS-76	Discon.	Standard Driver⊖	X
DS-85	Discon.	Standard Driver⊕	X
DST-01	1581	Stubby Driver	39
DST-02	1582	Stubby Driver	39
DST-05	1585	Combination Reversible Stubby Driver	39
DST-06	1586	Miniature Reversible Driver	39
DST-07	1587	Miniature Reversible Driver	39
DT-02	0502	Mobile Phone Driver	43
DT-04	0504	Mobile Phone Driver	43
DT-05	0505	Mobile Phone Driver	43
DT-06	0506	Mobile Phone Driver	43
DT-08	0548	Mobile Phone Driver	43
DT-10	0510	Mobile Phone Driver	43
DT-15	0515	Mobile Phone Driver	43
DT-20	0520	Mobile Phone Driver	43
DTC-20	0570	Mobile Phone Driver	43
DTC-27	0577	Mobile Phone Driver	43
DTH-03	Discon.	Mobile Phone Driver	X
DTP-03	0543	Pentalobe Driver	43
DTP-05	0545	Pentalobe Driver	43
DTX-04	0544	Mobile Phone Driver	43
DTX-08	0508	Mobile Phone Driver	43
DTY-02	0582	Mobile Phone Driver	43
DTY-03	0583	Mobile Phone Driver	43
DZ-01	0901	Miniature Driver	39
DZ-02	0902	Miniature Driver	39
DZ-03	Discon.	Cross Nut Driver	X
DZ-04	Discon.	Cross Nut Driver	X
DZ-05	Discon.	Cross Nut Driver Set	X
DZ-06	Discon.	Offset Driver	X
DZ-07	Discon.	Offset Driver	X
DZ-08	Discon.	Offset Driver Set	X
DZ-11	Discon.	Flexible Shaft Driver	X
DZ-12	Discon.	Flexible Shaft Driver	X
DZ-21	Discon.	Screw Holding Driver	X
DZ-23	Discon.	Screw Holding Driver	X
DZ-24	Discon.	Screw Holding Driver	X
DZ-25	Discon.	Screw Holding Driver	X

K

ITEM No.	CODE No.	ITEM	PAGE
KA-15	7115	ABS Attache Case	66
KA-22	7122	Attache Case (Wide Type)	65
KA-30	7130	Aluminium Case	67
KA-42	7142	Aluminium Case	67
KA-43	7143	Aluminium Case	67
KA-44	7144	Aluminium Case	67
KA-50	7150	Aluminium Case	66
KA-51	7151	Aluminium Case	66
KA-54	7154	Aluminium Attache Case	67
KA-57	7157	Aluminium Case	66
KA-91	Discon.	Aluminium Case	X
KAC-30	7230	Aluminium Case for Clean Room	67
KAC-42	7242	Aluminium Case for Clean Room	67
KD-01	Discon.	Panel Kits for Field Maintenance	X
KD-02	Discon.	Panel Kits for Field Maintenance	X
KD-03	Discon.	Panel Kits for Field Maintenance	X
KD-04	Discon.	Panel Kits for Electronics Work	X
KD-05	Discon.	Panel Kits for Electronics Work	X
KD-06	Discon.	Panel Kits for Electronics Work	X
KDE-01	Discon.	Panel	X
KDE-02	Discon.	Panel	X
KDE-03	Discon.	Panel	X
KDE-04	Discon.	Panel	X
KDE-05	Discon.	Panel	X
KDE-06	Discon.	Panel	X
KP-01	7401	Parts Box	68
KP-02	7402	Parts Box	68
KP-02K	7408	Parts Box (Heavy-Duty Type)	68
KP-03	7403	Parts Box	68
KP-03K	7409	Parts Box (Heavy-Duty Type)	68
KP-04	7404	Miniature Box	68
KP-51	7451	Ic Storage Box	68

KP-52	7452	Ic Storage Box	68
KP-95	7495	Dividing Plate	68
KP-96	7496	Dividing Plate	68
KP-97	7497	Dividing Plate	68
KS-01	7001	My Kit	60
KS-02	7002	My Kit	60
KS-03	7003	Tool Kit	62
KS-04	7004	Tool Kit	62
KS-05	7005	Maintenance Kit	61
KS-06	7006	Maintenance Kit	61
KS-06R	Discon.	Maintenance Kit	61
KS-08	7038	Electronics Kit	62
KS-09	Discon.	Tool Kit	62
KS-10	Discon.	Tool Kit	62
KS-11	7011	Tool Kit	64
KS-12	7012	Attache Tool Kit	64
KS-14	7014	Electronics Kit	63
KS-17	Discon.	Tool Kit	63
KS-18	Discon.	Tool Kit	63
KS-20	7020	My Kit	60
KS-27	7027	My Kit	60
KS-28	7028	Tool Kit	63
KS-30	Discon.	Attache Tool Kit	63
KS-31	Discon.	Attache Tool Kit	63
KS-34	7034	Screw Emergency Tool Kit	7
KSC-04	7504	Tool Kit	62
KSC-05	7505	Maintenance Kit	61
KSC-06	7506	Maintenance Kit	61
KSE-03	7053	Tool Case	62
KSE-04	7054	Tool Case	62
KSE-06	7056	Tool Case	61
KSE-09	Discon.	Tool Case with Panel	62
KSE-10	Discon.	Tool Case with Panel	62
KSE-11	7061	Tool Case with Panel	64
KSE-12	7062	Attache Case with Empty Panel	65
KSE-17	Discon.	Tool Case with Empty Panel	65
KSE-18	Discon.	Tool Case with Empty Panel	65
KSE-28	7078	Eva Tool Case with Panel	63
KSE-30	Discon.	Attache Case with Empty Panel	65
KSE-31	Discon.	Attache Case with Empty Panel	65

N

ITEM No.	CODE No.	ITEM	PAGE
NK-15	3115	Diagonal Nippers	18
NK-16	3116	Diagonal Nippers	18
NK-25	3125	Diagonal Nippers	18
NK-26	3126	Diagonal Nippers	18
NK-36	3136	Heavy Duty Diagonal Nippers	18
NN-45	3145	Slant Edge Nippers	19
NN-46	3146	Slant Edge Nippers	19
NN-56	3156	Slant Edge Nippers	19
NP-03	3083	Plastic Nippers	19
NP-04	3084	Plastic Nippers	19
NP-05	3085	Plastic Nippers	19
NS-03	3003	Micro Nippers	16
NS-04	3004	Micro Nippers	16
NS-06	3006	Micro Nippers	16
NSX-04	3001	Micro Nippers	16
NZ-03	3093	Chip Cutter	17
NZ-05	3095	Chip Cutter	17
NZ-12	3098	Parallel Nippers	17
NZ-13	3099	Parallel Nippers	17

P

ITEM No.	CODE No.	ITEM	PAGE
PA-01	3501	Wire Pliers	25
PA-02	Discon.	Wire Pliers	25
PA-03	3503	Wire Pliers	25
PA-04	Discon.	Wire Pliers	25
PA-05	3505	Wire Stripper	31
PA-06	3506	Wire Stripper	31
PA-07	3507	Wire Stripper	31
PA-08	Discon.	Connector Pliers	26
PA-09	3509	Micro Connector Pliers	26
PA-11	3511	Wire Stripper	28
PA-12	Discon.	Wire Stripper	28
PA-13	Discon.	Wire Stripper	28
PA-14	3514	Wire Stripper	31
PA-15	Discon.	Connector Pliers	26
PA-20	3520	Universal Crimping Pliers	26
PA-21	3521	Universal Crimping Pliers	26
PA-30	3530	Wire Stripper	28
PA-90	3590	Strip Gauge	31
PA-91	3591	Terminal Set	28
PA-92	3592	Terminal Set	28

PA-93	3593	Terminal Set	28
PAD-01	Discon.	Handy Crimp Tool Complete Set	27
PAD-02	3539	Handy Crimp Tool Complete Set	28
PAD-10	3531	Handy Crimp Tool Frame	27
PAD-11	3532	Handy Crimp Tool (S)	27
PAD-11S	3535	Interchangeable Die Set (S)	27
PAD-12	3533	Handy Crimp Tool (M)	27
PAD-12S	3536	Interchangeable Die Set (M)	27
PAD-13	3534	Handy Crimp Tool (L)	27
PAD-13S	3537	Interchangeable Die Set (L)	27
PAR-20	Discon.	Ratchet Crimping Connector Pliers	29
PAS-30	3570	Connector Extractor	29
PAS-31	3571	Connector Extractor	29
PAS-32	3572	Connector Extractor	29
PAS-33	3573	Connector Extractor	29
PAS-34	3574	Connector Extractor	29
PC-06	3386	Combination Pliers	23
PC-08	3388	Combination Pliers	23
PD-06	3376	Side Cutting Pliers	22
PD-07	3377	Side Cutting Pliers	22
PD-08	3378	Side Cutting Pliers	22
PDS-01	3544	Screw Removal Tool Kit	7
PGT-03	3543	GT Pack (Paulownia Box)	7
PH-01	3401	Lock Holder	30
PH-02	3402	Lock Holder	30
PH-03	3403	Lock Holder	30
PH-04	3404	Lock Holder	30
PH-05	Discon.	Lock Holder	30
PH-06	Discon.	Lock Holder	30
PH-31	Discon.	Electronic Snips	14
PH-32	Discon.	Electronic Snips	14
PH-33	3433	Electronic Snips	14
PH-34	3434	Electronic Snips	14
PH-50	3450	Combination Scissors	13
PH-51	Discon.	Combination Scissors	13
PH-55	3455	Combination Scissors GT	13
PH-56G	3456	Combination Scissors MP	12
PH-56R	3461	Combination Scissors MP	12
PH-56Y	3462	Combination Scissors MP	12
PH-57	3457	Combination Scissors DP	11
PH-57G	3458	Combination Scissors DP	11
PH-57R	3459	Combination Scissors DP	11
PH-57Y	3460	Combination Scissors DP	11
PK-50	3550	Cable Shears	14
PK-51	3551	Cable Shears	14
PL-05	3355	Long Flat Nose Pliers	22
PL-06	3356	Long Flat Nose Pliers	22
PM-06	3366	Round Nose Pliers	22
PR-15	3315	Long Nose Pliers	22
PR-16	3316	Long Nose Pliers	22
PR-26	3326	Long Nose Pliers	22
PR-36	3336	Long Nose Pliers	22
PR-46	3346	Needle Nose Pliers	22
PS-01	3201	Miniature Long Nose Pliers	21
PS-03	3203	Miniature Needle Nose Pliers	21
PS-04	3204	Miniature Flat Nose Pliers	21
PSS-01	Discon.	S/S Long Nose Pliers	21
PSS-02	Discon.	S/S Needle Nose Pliers	21
PSS-04	Discon.	S/S Flat Nose Pliers(Curved)	21
PT-01	3601	Tweezers(AA)	33
PT-02	3602	Tweezers(RR)	33
PT-03	3603	Tweezers(MM)	33
PT-04	3604	Tweezers(I)	33
PT-05	3605	Tweezers(GG)	33
PT-06	3606	Tweezers(J)	33
PT-07	3607	Tweezers(TS)	33
PT-08	3608	Tweezers	33
PT-09	3609	Tweezers	33
PT-10	3610	Tweezers	33
PT-11	3611	Tweezers	33
PT-12	3612	Tweezers(BS)	34
PT-13	3613	Tweezers	34
PT-14	3614	Reverse Action Tweezers	34
PT-15	3615	Tweezers	34
PT-16	3616	Solid Arm Tweezers	34
PT-17	3617	Solid Arm Tweezers	34
PT-19	Discon.	SMD Tweezers	34
PT-20	Discon.	SMD Tweezers	34
PT-21	Discon.	SMD Tweezers	34
PT-22	Discon.	SMD Tweezers	34
PT-23	Discon.	SMD Tweezers	34
PT-24	Discon.	SMD Tweezers	34
PT-25	Discon.	SMD Tweezers	34
PT-26	Discon.	SMD Tweezers	34
PT-28	Discon.	SMD Tweezers	34
PT-31	3629	Solid Arm Tweezers	34
PTK-90	3690	Tweezers' Soft Case	34
PTN-01	3661	Titanium Tweezers(AA)	34
PTN-02	3662	Titanium Tweezers(GG)	34
PTN-03	3663	Titanium Tweezers(J)	34
PTN-04	Discon.	Titanium Tweezers(TS)	34

PTS-01	3671	Tweezers	36
PTS-02	3672	Tweezers	36
PTS-03	3673	Tweezers	36
PTS-04	3674	Tweezers	36
PTS-05	3675	Tweezers	36
PTS-06	3676	Tweezers	36
PTS-07	3677	Tweezers	36
PTS-08	3678	Tweezers	36
PTZ-01	Discon.	Wafer Handling Tweezers	35
PTZ-41	3693	ESD Plastic-Tipped Tweezers	35
PTZ-42	3694	ESD Plastic-Tipped Tweezers	35
PTZ-43	3697	ESD Plastic-Tipped Tweezers	35
PTZ-45	3703	ESD Plastic-Tipped Tweezers	35
PTZ-46	3704	ESD Plastic-Tipped Tweezers	35
PTZ-51	3701	Ceramic-Tipped Tweezers	36
PTZ-61	3707	Black-Coated ESD Tweezers	36
PTZ-62	3708	Black-Coated ESD Tweezers	36
PTZ-63	3709	Black-Coated ESD Tweezers	36
PTZ-91	3695	Spare Tip for PTZ-41	35
PTZ-92	3696	Spare Tip for PTZ-42	35
PTZ-93	3698	Spare Tip for PTZ-43	35
PTZ-94	3702	Spare Tip for PTZ-51	36
PTZ-95	3705	Spare Tip for PTZ-45	35
PTZ-96	3706	Spare Tip for PTZ-46	35
PW-05	3395	Water Pump Pliers	23
PW-08	3398	Water Pump Pliers	23
PW-10	3390	Water Pump Pliers	23
PZ-01	3901	E-Ring Pliers	23
PZ-02	3902	E-Ring Pliers	23
PZ-10	Discon.	Snap Ring Pliers	23
PZ-11	Discon.	Tip for Snap Ring Pliers 0.7S	23
PZ-12	Discon.	Tip for Snap Ring Pliers 0.7C	23
PZ-13	Discon.	Tip for Snap Ring Pliers 1.4S	23
PZ-14	Discon.	Tip for Snap Ring Pliers 1.4C	23
PZ-16	3916	Snap Ring Pliers	23
PZ-17	3917	Snap Ring Pliers	23
PZ-18	3918	Snap Ring Pliers	23
PZ-19	3919	Snap Ring Pliers	23
PZ-22	3900	Screw Eater	3
PZ-32	3932	Screw Removal Pliers JS	6
PZ-55	3955	Screw Removal Pliers	5
PZ-56	3956	Screw Removal Pliers XP	5
PZ-57	3957	Screw Removal Pliers M2	5
PZ-58	3958	Screw Removal Pliers GT	4
PZ-59	3959	Screw Removal Pliers RX	4
PZ-60	3962	Screw Removal Pliers Z	4
PZ-64	3967	Screw Removal Locking Pliers	6
PZ-65	3968	Screw Removal Locking Pliers	6
PZM-30	3964	Pliers Mask for PZ-32	6
PZM-58	3963	Pliers Mask for PZ-58	4

S

ITEM No.	CODE No.	ITEM	PAGE
SD-06	Discon.	Digital Multimeter	77
SD-07	Discon.	Iron Thermometer	74
SD-10	5710	Digital Multimeter	77
SD-20	5720	Desoldering Tool	74
SD-21	5721	Heater Holder	74
SD-22	5722	Heater Assy	74
SD-23	5723	Pipe Setter	74
SD-24	5724	Filter Cartridge	74
SD-25	5725	Seat Valve	74
SD-26	5726	Diaphragm	74
SD-29	5729	Filter Pipe	74
SD-30	5730	Smd Accessory Kit	74
SD-31	5731	Stainless Wire Reel	74
SD-58	Discon.	Sensor Probe	74
SD-60	5760	Tool Stand for SD-20	74
SD-61	5761	φ0.8 Tip for SD-20	74
SD-62	5762	φ1.0 Tip for SD-20	74
SD-63	5763	φ1.5 Tip for SD-20	74
SD-86	5786	Hot Air Nozzle	74
SD-87	5787	Tapering Slim Tip	74
SD-88	5788	Tapering Slim Tip	74
SH-10	5410	Replacement Heater (100V)	70
SH-12	5412	Replacement Heater (220-240V)	71
SH-20	5420	Replacement Heater (100V)	70
SK-14	Discon.	Soldering Iron (Mica)	70
SK-30	5030	Soldering Iron	70
SK-31	5031	Soldering Iron	70
SK-32	5032	Soldering Iron (100V)	70
SK-40	5040	Soldering Iron (100V)	70
SK-41	5041	Soldering Iron (100V)	70
SK-42	5042	Tapered Needle for SKM-40	73
SK-43	5043	Chisel for SKM-40	73
SK-44	5044	φ2mm Spade for SKM-40	73
SK-45	5045	Chisel for SKM-40	73
SK-46	5046	Hot Blow Tip for SKM-40	73

SK-47	5047	Ejector Unit for SKM-40	73
SK-50	Discon.	Kotelyzer	
SK-51	Discon.	Tapered Needle for SK-50	
SK-52	Discon.	Chisel for SK-50	
SK-53	Discon.	φ2mm Spade for SK-50	
SK-54	Discon.	Chisel for SK-50	
SK-55	Discon.	Hot Blow Tip for SK-50	
SK-56	Discon.	Hot Blow Tip for SK-50	
SK-57	Discon.	Ejector Unit for SK-50	
SK-61	5061	Tapered Needle for SK-60	72
SK-62	5062	Chisel for SK-60	72
SK-63	5063	φ2mm Spade for SK-60	72
SK-64	5064	Chisel for SK-60	72
SK-65	5065	Hot Blow Tip for SK-60	72
SK-66	5066	Hot Blow Tip for SK-60	72
SK-67	5067	Hot Knife for SK-60	72
SK-68	5068	Ceramic Unit for SK-60	72
SK-70	Discon.	Kotelyzer	
SK-71	5071	Tapered Needle for SK-70	73
SK-72	5072	Chisel for SK-70	73
SK-73	5073	φ2mm Spade for SK-70	73
SK-74	5074	φ3mm Spade for SK-70	73
SK-75	5075	Tapered Needle for SK-70	73
SK-76	5076	φ2mm Spade for SK-70	73
SK-77	5077	Tapered Pyramid for SK-70	73
SK-78	5078	Offset Tapered Needle for SK-70	73
SK-79	5079	High Powered Chisel for SK-70	73
SK-80	5080	High Powered Round Head Needle for SK-70	73
SK-81	5081	High Powered Long Taper Chisel for SK-70	73
SK-82	5082	Hot Blow Tip for SK-70	73
SK-83	5083	Hot Blow Tip for SK-70	73
SK-84	5084	Hot Blow Tip for SK-70	73
SK-85	5085	Hook Fitting for SK-70	73
SK-88	5088	Protective Cap for SK-70	73
SK-89	5089	Cleaning Sponge for Kotelyzer	72
SK-90	5090	Gas Refill for Kotelyzer	73
SK-93	5093	Heat Shrink for SK-70	73
SK-94	5094	Heat Shrink for SK-70	73
SK-95	5095	Gas Refill for Kotelyzer	73
SK-96	5096	Ceramic Unit for SK-70	73
SKA-50	Discon.	Kotelyzer	
SKA-60	5105	Kotelyzer	72
SKA-70	5101	Kotelyzer	73
SKB-60	5106	Kotelyzer	72
SKB-70	5102	Kotelyzer	73
SKC-30	5130	Soldering Iron	70
SKC-31	5131	Soldering Iron	70
SKC-32	5132	Soldering Iron (100V)	70
SKC-40	5140	Soldering Iron (100V)	70
SKC-41	5141	Soldering Iron (100V)	70
SKC-60	5107	Kotelyzer	72
SKC-70	5103	Kotelyzer	73
SKD-70	5104	Kotelyzer	73
SKE-30	5180	Soldering Iron	70
SKE-31	5181	Soldering Iron	70
SKE-32	Discon.	Soldering Iron (100V)	
SKE-40	Discon.	Soldering Iron (100V)	
SKE-41	Discon.	Soldering Iron (100V)	
SKM-40	5108	Handy Kotelyzer	73
SL-01	5801	Inspection Mirror	79
SL-02	5802	Inspection Mirror	79
SL-03	5803	Inspection Mirror	79
SL-04	5804	Desk-Top Loupe	79
SL-07	5807	Desk-Top Loupe	79
SL-11	5811	Inspection Mirror	79
SL-12	5812	Inspection Loupe	78
SL-22	5822	LED Light Loupe	79
SL-23	5823	LED Stand Loupe	79
SL-50	5850	Pocket Loupe	78
SL-51	5851	Pocket Loupe	78
SL-52	5852	Pocket Loupe	78
SL-53	5853	Pocket Loupe	78
SL-55	5855	Inspection Loupe	78
SL-56	5856	Inspection Loupe	78
SL-57	5857	Inspection Loupe	78
SL-58	Discon.	Inspection Loupe	
SL-60	Discon.	Stereo Microscope	
SL-62	Discon.	Microscope Cmos Camera	
SL-64	5896	Foldable Magnifier	78
SL-65	Discon.	Eyeiece with Micro Scale	
SL-66	Discon.	Eyeiece with Micro Scale	
SL-71	5871	Flashlight Loupe	79
SL-72	5872	Utility Loupe	79
SL-80	5880	Head Loupe	79
SL-81	5881	Head Loupe	79
SL-82	5882	Head Loupe	79
SL-83	5883	Head Loupe	79
SL-85	5885	Replacement Lens for Head Loupe	79
SL-86	5886	Replacement Lens for Head Loupe	79
SL-87	5887	Replacement Lens for Head Loupe	79
SL-88	5888	Replacement Lens for Head Loupe	79

SS-01	5501	Solder Sucker	75
SS-02	5502	Solder Sucker	75
SS-05	5505	Tip Cleaner	75
SS-08	5508	Ic Extractor	72
SS-09	Discon.	Soldering Box	
SS-10	5510	PCB Connector Extractor	72
SS-11	5511	Replacement Nozzle	75
SS-15	5515	2P-3P Plug Converter	74
SS-16	5516	Replacement Silicone Tubes	75
SS-20	5520	Iron Stand	75
SS-21	5521	Spring Hook	30
SS-22	5522	Spring Hook	30
SS-30	5530	Pin Extractor	29
SS-31	5531	Pin Extractor	29
SS-32	5532	Pin Extractor	29
SS-33	5533	Pin Extractor	29
SS-34	5534	Pin Extractor	29
ST-10	5210	Replacement Tip for SK-30	70
ST-11	5211	Replacement Tip for SK-30	70
ST-12	5212	Replacement Tip for SK-30	70
ST-13	5213	Replacement Tip for SK-30	70
ST-14	5214	Replacement Tip for SK-30	70
ST-20	5220	Replacement Tip	70
ST-21	5221	Replacement Tip	70
ST-22	5222	Replacement Tip	70
ST-23	5223	Replacement Tip	70
SW-11	5611	Solder	77
SW-12	5612	Solder	77
SW-13	5613	Solder	77
SW-21	5621	Solder	77
SW-22	5622	Solder	77
SW-23	5623	Solder	77
SW-30	5630	Solder	77
SW-31	5631	Solder	77
SW-32	5632	Solder	77
SW-33	5633	Solder	77
SW-41	5641	Solder	77
SW-42	5642	Solder	77
SW-43	5643	Solder	77
SW-51	5651	Solder	77
SW-52	5652	Solder	77
SW-53	5653	Solder	77
SWA-06	4006	Superiot RA Solder	76
SWA-08	4008	Superiot RA Solder	76
SWA-10	4010	Superiot RA Solder	76
SWA-12	4012	Superiot RA Solder	76
SWA-56	4056	Superiot RA Solder	76
SWA-58	4058	Superiot RA Solder	76
SWA-60	4060	Superiot RA Solder	76
SWA-62	4062	Superiot RA Solder	76
SWA-76	4076	Superiot RA Solder	76
SWA-78	4078	Superiot RA Solder	76
SWA-80	4080	Superiot RA Solder	76
SWA-82	4082	Superiot RA Solder	76
SWS-06	4106	Superiot RMA Solder	76
SWS-08	4108	Superiot RMA Solder	76
SWS-10	4110	Superiot RMA Solder	76
SWS-12	4112	Superiot RMA Solder	76
SWS-56	4156	Superiot RMA Solder	76
SWS-58	4158	Superiot RMA Solder	76
SWS-60	4160	Superiot RMA Solder	76
SWS-62	4162	Superiot RMA Solder	76
SWS-76	4176	Superiot RMA Solder	76
SWS-78	4178	Superiot RMA Solder	76
SWS-80	4180	Superiot RMA Solder	76
SWS-82	4182	Superiot RMA Solder	76
SWU-02	5605	Solder Wick	76
SWU-03	5606	Solder Wick	76
SWU-04	5607	Solder Wick	76
SWU-05	5608	Solder Wick	76
SWU-06	5609	Solder Wick	76

T

ITEM No.	CODE No.	ITEM	PAGE
TD-03	6403	Twist Drill	56
TD-04	6404	Twist Drill	56
TD-05	6405	Twist Drill	56
TD-06	6406	Twist Drill	56
TD-07	6407	Twist Drill	56
TD-08	6408	Twist Drill	56
TD-09	6409	Twist Drill	56
TD-10	6410	Twist Drill	56
TD-12	6412	Twist Drill	56
TD-15	6415	Twist Drill	56
TD-16	6416	Twist Drill	56
TD-18	6418	Twist Drill	56
TD-20	6420	Twist Drill	56
TD-25	6425	Twist Drill	56

TD-30	6430	Twist Drill	56
TD-32	6432	Twist Drill	56
TD-35	6435	Twist Drill	56
TD-40	6440	Twist Drill	56
TD-50	6450	Twist Drill	56
TD-60	6460	Twist Drill	56
TDS-01	6471	Twist Drill Set	56
TDS-02	6472	Twist Drill Set	56
TDS-03	6473	Twist Drill Set	56
TF-01	Discon.	File	
TF-02	Discon.	File	
TF-03	Discon.	File	
TF-04	Discon.	File	
TF-05	Discon.	File	
TF-06	6536	File	57
TF-07	6537	File	57
TF-10	6540	File	57
TF-11	6541	Jet Black File	58
TF-12	6542	Jet Black File	58
TF-13	6543	Jet Black File	58
TF-14	6547	Jet Black File	58
TF-15	6548	Jet Black File	58
TF-21	6544	Jet Black File	58
TF-22	6545	Jet Black File	58
TF-23	6546	Jet Black File	58
TF-24	6549	Jet Black File	58
TF-25	6550	Jet Black File	58
TF-31	6641	Jet Black File	58
TF-32	6642	Jet Black File	58
TF-33	6643	Jet Black File	58
TF-34	6644	Jet Black File	58
TF-35	6645	Jet Black File	58
TF-41	6646	Jet Black File	58
TF-42	6647	Jet Black File	58
TF-43	6648	Jet Black File	58
TF-44	6649	Jet Black File	58
TF-45	6650	Jet Black File	58
TFS-01	6551	File Set	58
TFS-02	6552	File Set	58
TFS-03	Discon.	File Set(Precise Type)	
TFS-04	Discon.	File Set(Precise Type)	
TFS-06	Discon.	File Set(Precise Type)	
TFS-07	6557	Jet Black File Set	58
TFS-10	6558	Jet Black File Set	58
TFS-20	6559	Jet Black File Set	58
TFS-30	6560	Jet Black File Set	58
TG-02	Discon.	Grinder	
TH-01	Discon.	Hammer	
TH-02	Discon.	Hammer	
TH-05	Discon.	Hammer	
TM-04	6624	Steel Rule	57
TM-05	6625	Steel Rule	57
TN-01	6101	Jeweller's Saw	57
TN-02	6102	Jeweller's Saw	57
TN-03	6103	Jeweller's Saw	57
TN-04	6104	Jeweller's Saw	57
TN-05	6105	Jeweller's Saw	57
TN-11	6111	Saw Blade	57
TN-12	6112	Saw Blade	57
TN-13	6113	Saw Blade	57
TN-14	6114	Saw Blade	57
TN-15	6115	Saw Blade	57
TN-16	6116	Saw Blade	57
TN-17	6117	Saw Blade	57
TN-18	6118	Saw Blade	57
TP-20	6020	Mini Drill Chuck	56
TP-21	Discon.	Pin Vise	
TP-22	Discon.	Pin Vise	
TP-23	6023	Pin Vise	56
TP-24	6024	Pin Vise	56
TP-25	Discon.	Pin Vise(for Drilling Machine)	
TP-26	Discon.	Pin Vise(for Mini Motor)	
TP-28	Discon.	Pin Vise(for Mini Motor)	
TP-31	Discon.	Pick-Up Tool	
TP-33	6033	Pick-Up Tool	30
TP-34	6034	Pick-Up Tool	30
TP-35	6035	Magnetic Pick-Up Tool	30
TP-36	6036	Magnetic Pick-Up Tool	30
TR-01	6611	Taper Reamer	56
TR-02	6612	Taper Reamer	56
TR-03	6613	Taper Reamer	56
TR-04	6614	Taper Reamer	56
TS-01	Discon.	Mini Spanner Set	
TS-02	Discon.	Mini Spanner Set	
TS-04	6364	Mini Combination Spanner Set	52
TS-05	6365	Open-End Wrench Set	52
TS-06	6366	Combination Wrench Set	52
TS-07	6367	Combination Wrench Set	52
TS-11	Discon.	Spanner(Flat Head)	
TS-12	Discon.	Spanner(Flat Head)	
TS-13	Discon.	Spanner(Flat Head)	

TS-14	Discon.	Spanner(Flat Head)	✕
TS-15	Discon.	Spanner(Flat Head)	✕
TS-21	Discon.	Spanner(Inclined Head)	✕
TS-22	Discon.	Spanner(Inclined Head)	✕
TS-23	Discon.	Spanner(Inclined Head)	✕
TS-24	Discon.	Spanner(Inclined Head)	✕
TS-25	Discon.	Spanner(Inclined Head)	✕
TS-41	6281	Combination Spanner	52
TS-42	6282	Combination Spanner	52
TS-43	6283	Combination Spanner	52
TS-44	6284	Combination Spanner	52
TS-45	6285	Combination Spanner	52
TS-46	6286	Combination Spanner	52
TS-47	6287	Combination Spanner	52
TS-48	6288	Combination Spanner	52
TT-01	6501	Tap Handle	56
TT-02	6502	Tap Handle	56
TT-03	6503	Tap Set	56
TT-10	6510	Tap	56
TT-11	6511	Tap	56
TT-12	6512	Tap	56
TT-13	6513	Tap	56
TT-14	6514	Tap	56
TT-15	6515	Tap	56
TT-16	6516	Tap	56
TV-01	6561	Bench Vise	57
TV-02	6562	Bench Vise	57
TV-03	6563	Bench Vise	57
TV-04	6564	Bench Vise	57
TV-11	6571	Anvil Vise	57
TV-12	6572	Anvil Vise	57
TV-13	6573	Anvil Vise	57
TV-14	6574	Anvil Vise	57
TV-25	6585	Yankee Vise	57
TV-26	6586	Yankee Vise	57
TV-27	6587	Yankee Vise	57
TV-31	Discon.	Clamp	✕
TV-32	Discon.	Clamp	✕
TV-34	Discon.	Clamp	✕
TWB-00	Discon.	Ball Point Hex Wrench	✕
TWB-01	6201	Ball Point Hex Wrench Set (Long)	53
TWB-02	6202	Ball Point Stubby Wrench Set	53
TWB-04	6204	Ball Point Wrench Set (Short)	53
TWB-05	6205	Ball Point Stubby Wrench Set	53
TWB-13	6213	Ball Point Hex Wrench	53
TWB-15	6215	Ball Point Hex Wrench	53
TWB-20	6220	Ball Point Hex Wrench	53
TWB-25	6225	Ball Point Hex Wrench	53
TWB-30	6230	Ball Point Hex Wrench	53
TWB-40	6240	Ball Point Hex Wrench	53
TWB-50	6250	Ball Point Hex Wrench	53
TWB-60	6260	Ball Point Hex Wrench	53
TWB-80	6280	Ball Point Hex Wrench	53
TWH-01	6301	Hex Key Wrench Set	53
TWH-02	6302	Hex Key Wrench Set	53
TWH-04	6304	Hex Key Wrench Set	53
TWH-11	6311	Hex Key Wrench	53
TWH-12	6312	Hex Key Wrench	53
TWH-13	6313	Hex Key Wrench	53
TWH-14	6314	Hex Key Wrench	53
TWH-15	6315	Hex Key Wrench	53
TWH-16	6316	Hex Key Wrench	53
TWH-17	6317	Hex Key Wrench	53
TWH-18	6318	Hex Key Wrench	53
TWH-20	6320	Hex Key Wrench	53
TWH-21	6321	Hex Key Wrench	53
TWH-22	6322	Hex Key Wrench	53
TWH-23	6323	Hex Key Wrench	53
TWH-24	6324	Hex Key Wrench	53
TWH-25	6325	Hex Key Wrench	53
TWH-26	Discon.	Hex Key Wrench	✕
TWM-01	6351	Adjustable Angle Wrench	51
TWM-02	6352	Adjustable Angle Wrench	51
TWM-03	6353	Smart Monkey Wrench	51
TWM-04	6354	Adjustable Angle Wrench	51
TWM-05	6355	Adjustable Angle Wrench	51
TWM-07	6357	Smart Monkey Wrench	51
TWM-08	6358	Smart Monkey Wrench	51
TWS-01	6341	Socket Wrench Set (Inch Size)	54
TWS-02	6342	Socket Wrench Set	54
TWS-03	6343	Socket Wrench Set	54
TWS-04	6344	Socket Wrench Set	54
TWS-05	6345	Socket Wrench Set	54
TZ-02	6902	Handy Saw	57
TZ-03	6903	Hack Saw	57
TZ-04	6904	Replacement Blade	57
TZ-05	6905	Scriber	57
TZ-07	6907	Punch	57
TZ-08	Discon.	Anvil	✕

Z

ITEM No.	CODE No.	ITEM	PAGE
ZC-01	9001	Conductive Foam	81
ZC-02	9002	Conductive Foam	81
ZC-03	Discon.	Conductive Foam	✕
ZC-11	Discon.	Super Oil Spray	✕
ZC-12	Discon.	Handy Grease Spray	✕
ZC-13	Discon.	Silicon Oil	✕
ZC-14	Discon.	Oil	✕
ZC-15	Discon.	Tap & Drill Oil	✕
ZC-16	Discon.	Rust Preventive	✕
ZC-17	Discon.	Silicon Grease	✕
ZC-18	Discon.	Super Grease	✕
ZC-19	9019	Oiler	84
ZC-28	9028	Rust Remover	84
ZC-31	Discon.	Aero Duster	✕
ZC-32	Discon.	Aero Duster	✕
ZC-38	9038	Dust-Free Gloves (S)	82
ZC-39	9039	Dust-Free Gloves (M)	82
ZC-40	9040	Dust-Free Gloves (L)	82
ZC-41	9041	Dust-Free Gloves (S)	82
ZC-42	9042	Dust-Free Gloves (M)	82
ZC-43	9043	Dust-Free Gloves (L)	82
ZC-44	9044	Static Conductive Gloves (S)	82
ZC-45	9045	Static Conductive Gloves (M)	82
ZC-46	9046	Static Conductive Gloves (L)	82
ZC-47	9047	Static Conductive Gloves (S)	82
ZC-48	9048	Static Conductive Gloves (M)	82
ZC-49	9049	Static Conductive Gloves (L)	82
ZC-50	9050	Wrist Strap	81
ZC-51	9051	Anti-Static Gloves (S)	82
ZC-52	9052	Anti-Static Gloves (M)	82
ZC-53	9053	Anti-Static Gloves (L)	82
ZC-54	9054	Anti-Static Gloves (S)	82
ZC-55	9055	Anti-Static Gloves (M)	82
ZC-56	9056	Anti-Static Gloves (L)	82
ZC-62	9062	Ground Cord	83
ZC-63	9063	Connective Plate	83
ZC-70	9070	Flux	74
ZC-71	9071	Flux Dispenser	74
ZC-80	9080	Anti-Static Service Kit	81
ZC-82	9082	Static Conductive Bag	82
ZC-84	9084	Static Conductive Bag	82
ZC-86	9086	Static Conductive Bag	82
ZC-92	9092	Anti-Static Bag	82
ZC-94	9094	Anti-Static Bag	82
ZC-96	9096	Anti-Static Bag	82
ZCM-01	9121	Conductive Colored Mat 10M	83
ZCM-02	9122	Conductive Colored Mat 2M	83
ZCM-03	9123	Conductive Colored Mat 1M	83
ZCM-04	9124	Conductive Colored Mat 0.5M	83

ENGINEER INC.

**2-8-9 HIGASHI-IMAZATO, HIGASHINARI-KU,
OSAKA 537-0011, JAPAN**

TEL +81-6-6974-0028

FAX +81-6-6974-5661

WEB <http://www.engineer.jp>



X-ON Electronics

Largest Supplier of Electrical and Electronic Components

Click to view similar products for [Hand Tools](#) category:

Click to view products by [Engineer manufacturer](#):

Other Similar products are found below :

[58284-1](#) [662908-1](#) [68764-0001](#) [690619-6](#) [D20419-189](#) [7-354778-7](#) [768531-1](#) [821903-5](#) [822253-1](#) [854183-1](#) [854358-1](#) [992258-1](#) [1-21046-3](#)
[1-22278-0](#) [1-22278-2](#) [1-24954-2](#) [125529-5](#) [126513-1](#) [1-305579-8](#) [1320846-1](#) [1338618-1](#) [1338968-2](#) [1-354779-0](#) [1-354779-2](#) [1-354779-4](#)
[1424443-1](#) [1424289-1](#) [1424444-1](#) [MS24256A16](#) [1-525442-0](#) [1532195-2](#) [1538773-2](#) [1-59681-8](#) [1-59907-5](#) [1-692134-3](#) [1725760-1](#) [HT-](#)
[920A-124-HTELE-RPL-KIT](#) [1976923-1](#) [1976969-1](#) [2063794-1](#) [2063795-1](#) [2-21002-1](#) [2-21002-3](#) [2-21002-4](#) [2-21002-7](#) [2-21002-9](#) [2-21004-](#)
[0](#) [229399-2](#) [229707-1](#) [911737-2](#)