

SCREW REMOVAL

Screw Removal Pliers, Rapid Screw Extractor, etc.

2

SCREW
REMOVAL

SCISSORS

Combination Scissors, Cable Shears, etc.

10

SCISSORS

NIPPERS

Micro Nippers, Parallel Nippers, Diagonal Nippers, Plastic Nippers, etc.

15

NIPPERS

PLIERS

Miniature Pliers, Long Nose Pliers, Combination Pliers, E-Ring Pliers, etc.

20

PLIERS

CRIMPING AND STRIPPING

Handy Crimp Tool, Universal Crimping Pliers, Pin Extractor, Wire Strippers, etc.

24

CRIMPING
STRIPPING

TWEEZERS

Tweezers, Titanium Tweezers, ESD Plastic-Tipped Tweezers, etc.

32

TWEEZERS

SCREWDRIVERS

Master Grip Drivers, Pro-Use Drivers, Stubby Drivers, Offset Ratchet Drivers, etc.

37

SCREW
DRIVERS

SPECIAL DRIVERS

Mobile Phone Drivers, Nut Drivers, Hex Drivers, Ceramic Alignment Screwdrivers, etc.

42

SPECIAL
DRIVERS

WRENCHES

Smart Monkey Wrench, Ball Point Hex Wrench Set, Socket Wrench Set, etc.

50

WRENCHES

CUTTING AND PROCESSING

Taper Reamer, Vise, Jeweller's Saw, Jet Black Files, etc.

55

CUTTING
PROCESSING

SETS AND CASES

Maintenance Kits, Tool Kits, Electronics Kits, Aluminium Cases, Parts Boxes, etc.

59

SETS
CASES

SOLDERING EQUIPMENT

Soldering Irons, Kotelyzers, Desoldering Tool, Solder Sucker, Digital Multimeter, Loupes, etc.

69

SOLDERING
EQUIPMENT

ESD PRODUCTS AND CHEMICALS

Anti-Static Service Kit, Dust-Free Gloves, Conductive Colored Mat, Rust Remover, etc.

80

ESD
CHEMICALS



Screw Removal

SCREW REMOVAL PLIERS SERIES

PATENTED TECHNIQUE

Remove all kinds of screws, fasteners, pins, etc. easily!

PZ-22

RoHS SCREW EATER

Finally, the world-standard model of the Screw Removal Pliers!

- Vertical serrations bite and grip a screw head without slippage.
- Also good for Truss head screw. *Truss: Lower-profile dome head
- Also ideal for situations when the correct size or type of screwdriver is not available.
- Serrated side teeth lined consecutively, inter-meshed with each other. Good for holding a thin plate securely.
- Owing to T-shaped forging handles, the handle sleeve will not twist or slip off during heavy duty use.

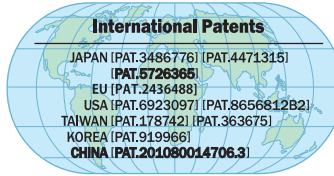

Vertical serrations

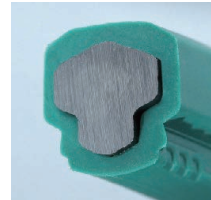

T-shaped handle

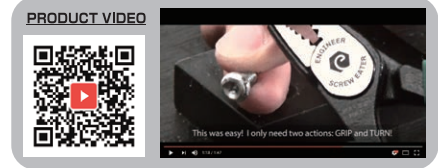

Vertical Serrations (PAT.)

You can remove damaged screws in seconds. Just grip and turn!



Inter-meshed Teeth (PAT.)

Need to hold a thin material? Get a firm grip!



How does it work?

Ordinary pliers

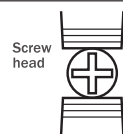

Ordinary plier jaws are lined with horizontal serrations. When you grasp and turn a screw head with ordinary pliers, the jaws slip and the screw remains stuck.

"Vertical serrations"

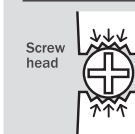

Specially-designed jaws generate gripping power.

"Maximizes the friction"



Perfect fitting serrations maximize friction with no slippage.

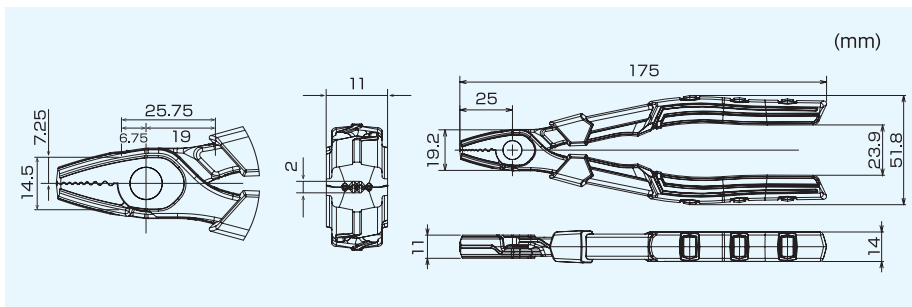

Screw head size

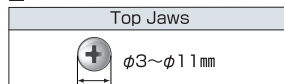

| Item No. | Material | Hardness | Wgt.(g) |
|----------|--------------|----------|---------|
| PZ-22 | Carbon Steel | HRC60±2 | 165 |

Rust Remover (ZC-28)

Screw stuck due to rust? Try our Rust Remover to remove the rust off screws within seconds!

Turn to page 84 for further information.

Works in seconds
 Penetrates along threads
 Low harmful to skin

SCREW REMOVAL

SCISSORS

NIPPERS

PLIERS

CRIMPING STRIPPING

TWEEZERS

SCREW DRIVERS

SPECIAL DRIVERS

WRENCHES

CUTTING PROCESSING

SETS CASES

SOLDERING EQUIPMENT

ESD CHEMICALS



Remove all kinds of screws, fasteners, pins, etc. easily!

PZ-58

RoHS SCREW REMOVAL PLIERS GT

The best selling Screw Removal Pliers in the whole world!!

- Elaborately-designed serration fits the profile of screw head at the best angle.
- Also good for Truss head screw. *Truss: Lower-profile dome head
- with wire cutter (Capacity: copper wire ϕ 1.2mm)
- Owing to T-shaped forging handles, the handle sleeve will not twist or slip off during heavy duty use.



PZM-58 RoHS PLIERS MASK FOR PZ-58

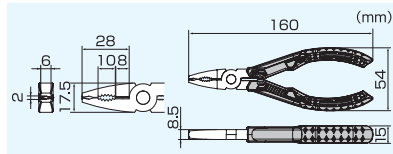
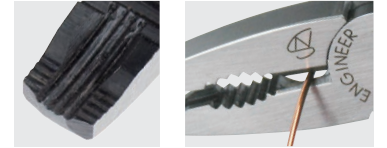

| Item No. | Material | Hardness | Wgt. (g) |
|----------|--------------|---------------|----------|
| PZ-58 | Carbon Steel | HRC58 \pm 2 | 130 |

■ Screw head size
Top Jaws

| | |
|--|------------------------|
| | ϕ 3~ ϕ 9.5mm |
|--|------------------------|

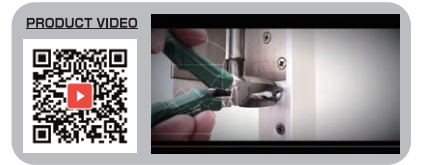

PZ-59

RoHS SCREW REMOVAL PLIERS RX

- Removes screws with stripped or rusted heads or stubborn fasteners in seconds
- Also good for Truss head screw. *Truss: Lower-profile dome head
- Inter-meshed side teeth even hold a very thin plate securely, no slippage!
- Owing to T-shaped forging handles, the handle sleeve will not twist or slip off during heavy duty use.

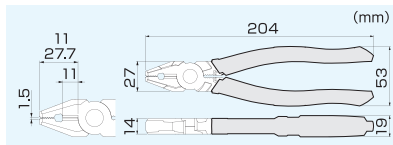
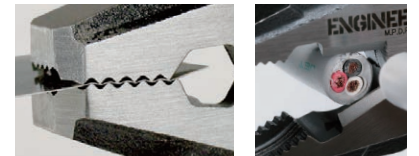

| Item No. | Material | Hardness | Wgt. (g) |
|----------|--------------|---------------|----------|
| PZ-59 | Carbon Steel | HRC60 \pm 2 | 300 |

■ Screw head size
Top Jaws

| | |
|--|-----------------------|
| | ϕ 3~ ϕ 15mm |
|--|-----------------------|

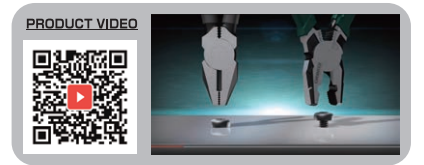

PZ-60

RoHS SCREW REMOVAL PLIERS Z

- Long nose ideal for a hard-to-reach small screws up to 5.5mm
- Vertical serrations bite a screw head without slippage.
- Also good for Truss head screw. *Truss: Lower-profile dome head
- Inter-meshed teeth to hold even a thin plate securely, so no slippage.
- Owing to T-shaped forging handles, the handle sleeve does not twist or slip off the handle.

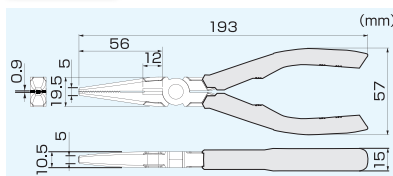
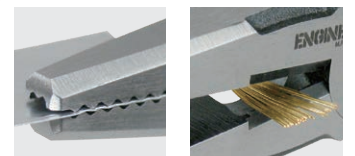

| Item No. | Material | Hardness | Wgt. (g) |
|----------|--------------|---------------|----------|
| PZ-60 | Carbon Steel | HRC60 \pm 2 | 180 |

■ Screw head size
Top Jaws

| | |
|--|-------------------------------------------------|
| | ϕ 2~ ϕ 5.5mm (Head Height < 2.2mm) |
|--|-------------------------------------------------|



PZ-55

SCREW REMOVAL PLIERS

The basic Screw Removal Pliers: Powerful and simple!

- Serrated jaw inside bites screw head firm and unfastens it with no slip.
- More powerful torque than screwdriver toward screw & nut
- Also ideal for rotating nut in case of no space to drive wrench in arc
- ※ For screw whose head was damaged and transformed
- ※ For screw whose slot on the head is special, unique or tamper-proof
- ※ For screw frozen with rust

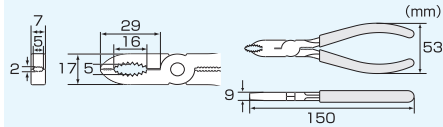

■ Screw head size

| |
|--------------------------------|
| Top Jaws |
| $\phi 3 \sim \phi 8 \text{mm}$ |

| Item No. | Material | Hardness | Wgt.(g) |
|----------|----------|----------|---------|
| PZ-55 | S58C | HRC56±2 | 125 |

PZ-56

SCREW REMOVAL PLIERS XP

Feel the powerful and extensive work !!

- Slip joint function makes it possible to select two points of opening jaws.
- Reverse cross-jointed structure to reduce the load which is imposed at joint bolt while unfastening work.

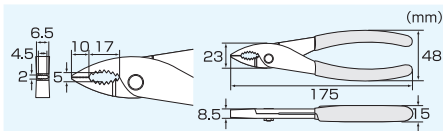
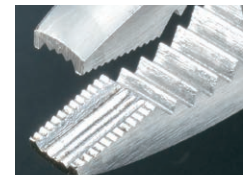
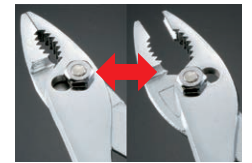

■ Screw head size

| |
|---------------------------------|
| Top Jaws |
| $\phi 3 \sim \phi 10 \text{mm}$ |

| Item No. | Material | Hardness | Wgt.(g) |
|----------|----------|----------|---------|
| PZ-56 | Cr-V | HRC56±2 | 187 |

PZ-57

SCREW REMOVAL PLIERS M2

Slender jaws and pocket-sized body

- Ideal for unfastening frozen or special screws of tiny size
- ESD-Safe handle made of thermoplastic Elastomer (TPR) featuring comfortable grip



with strap hole



ESD-Safe handle (1x10⁶~10⁷Ω/sq)

Top Jaws Side Jaws

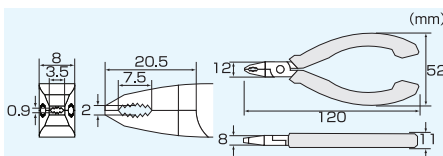

■ Screw head size

| |
|----------------------------------|
| Top Jaws |
| $\phi 2 \sim \phi 3.5 \text{mm}$ |

| Item No. | Material | Hardness | Wgt.(g) |
|----------|----------|----------|---------|
| PZ-57 | S58C | HRC56±2 | 100 |



PCB



Hard Disk Drive



Damaged screw



Torx screw

SCREW REMOVAL

SCISSORS

NIPPERS

PLIERS

CRIMPING STRIPPING

TWEEZERS

SCREW DRIVERS

SPECIAL DRIVERS

WRENCHES

CUTTING PROCESSING

SETS CASES

SOLDERING EQUIPMENT

ESD CHEMICALS

PZ-32

1RoHS SCREW REMOVAL PLIERS JS

- Vertical serrations bite and grip a screw head without slippage.
- Also good for Truss head screw. *Truss: Lower-profile dome head
- Serrated side teeth lined consecutively, inter-meshed with each other
- Black oxide finish to increase rust-resistance!
- Owing to T-shaped forging handles, the handle sleeve will not twist or slip off during heavy duty use.



PZM-30 1RoHS PLIERS MASK FOR PZ-32

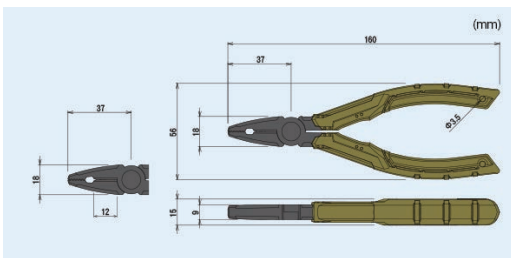

Inter-meshed, never let go.

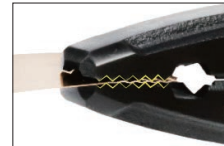

Strap hole goes through the steel handle.



■ Screw head size

| Top Jaws |
|-----------------------------------|
| ⊕ $\phi 3 \sim \phi 9.5\text{mm}$ |

| Item No. | Size | Material | Hardness | Cutting Capacity | Wgt. | Safety Hole |
|----------|-------|----------------------------------|----------|--------------------------------------|------|---------------------|
| PZ-32 | 160mm | Body:Carbon Steel Handles:TPR | HRC60±2 | $\phi 1.2\text{mm}$ (copper wire) | 125g | $\phi 3.5\text{mm}$ |

PZ-64·65

1RoHS SCREW REMOVAL LOCKING PLIERS

- Vertically serrated jaws bite a screw head while locking it securely. It helps to optimize your hand strength for twisting off stubborn screws.
- Also good for Truss head screw. *Truss: Lower-profile dome head
- Quick release mechanism, just open the handles to unlock the gripping jaws
- Rubber handles provide you with a comfortable grip.

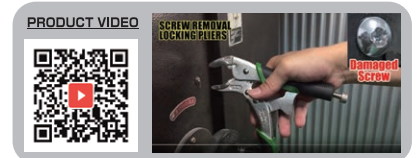
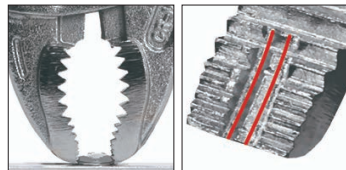

PZ-65



PZ-64

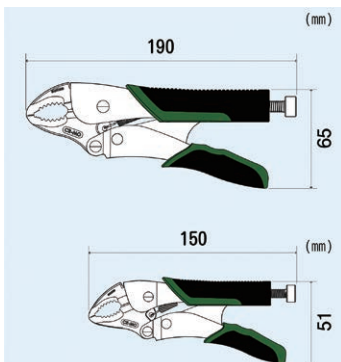

■ Screw head size

| Item No. | Top Jaws |
|----------|-----------------------------------|
| PZ-64 | ⊕ $\phi 3 \sim \phi 9.5\text{mm}$ |
| PZ-65 | ⊕ $\phi 7 \sim \phi 12\text{mm}$ |

| Item No. | Max.Jaws | Cutting Capacity | O.A. Length | Hardness (Jaws) | Wgt. | Material |
|----------|----------|--------------------------------|-------------|-----------------|------|-------------|
| PZ-64 | 38mm | Steel wire $\phi 1.6\text{mm}$ | 150mm | HRC57±3 | 205g | Body:Cr-Mo |
| PZ-65 | 48mm | Steel wire $\phi 2.3\text{mm}$ | 190mm | | 400g | Handles:TPR |

KS-34**SCREW EMERGENCY TOOL KIT**

The all-in-one solution for your screw troubles!

- Screw Eater + Rapid Screw Extractor with 3 bits
 - Lightweight and stylish bundle case
- *Turn to page 08 for more information on the Rapid Screw Extractor

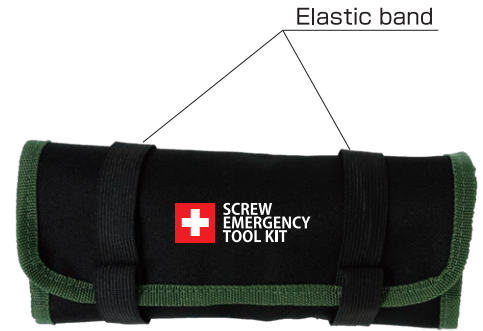

Compact and lightweight!

■ Contents

| Item No. | Description |
|----------|------------------------------|
| PZ-22 | Screw Eater |
| DBZ-50G | Handle Grip for DBZ (Green) |
| DBZ-51 | ⊕#2 (Press & Twist type bit) |
| DBZ-52 | ⊕#2 (Strike & Turn type bit) |
| DBZ-57 | ⊕#1 (Press & Twist type bit) |
| | Bundle case |

| Item No. | Case Size (When unfold) | Wgt. |
|----------|-------------------------|------|
| KS-34 | 380×220mm | 394g |

PDS-01**SCREW REMOVAL TOOL KIT**

Screw Removal Pliers GT with Mask
+ Rapid Screw Extractor with 5 bits
in a compact heavy duty case

*Turn to page 08 for more information on the Rapid Screw Extractor



■ Contents

| Item No. | Description |
|----------|-------------------------------|
| PZ-58 | Screw Removal Pliers GT |
| PZM-58 | Pliers Mask for PZ-58 |
| DBZ-50B | Handle Grip For DBZ (Black) |
| DBZ-51 | ⊕#2 (Press & Twist type bit) |
| DBZ-52 | ⊕#2 (Strike & Turn type bit) |
| DBZ-53 | Hex socket screw(●:2.5-3.0mm) |
| DBZ-54 | Hex socket screw(●:4.0mm) |
| DBZ-56 | Hex socket screw(●:5.0mm) |
| | Bit holder |

PGT-03 GT PACK(PAULOWNIA BOX)

The perfect gift for tool lovers!

- The Screw Removal Pliers GT and the Combination Scissors GT in a beautiful box made of paulownia wood.



■ Contents

| Item No. | Description |
|----------|-------------------------|
| PZ-58 | Screw Removal Pliers GT |
| PZM-58 | Pliers Mask for PZ-58 |
| PH-55 | Combination Scissors GT |

| Item No. | Case Size | Wgt. |
|----------|--------------|------|
| PGT-03 | 252×132×32mm | 372g |

| Item No. | Case Size | Wgt. |
|----------|--------------|------|
| PDS-01 | 300×63×200mm | 896g |

DBZ-60G**RoHS RAPID SCREW EXTRACTOR**

The unique extracting tool, especially designed to remove damaged countersunk screws!

- Special screw driver for screw extraction
- No power supply or drilling required
- 2 bits for more possibilities
- High-torque handle grip
- Shock-absorbable rubber sleeve included

Contents:

- Handle Grip for DBZ(Green)(DBZ-50G)
- ⊕#2 Press & Twist type bit (DBZ-51)
- ⊕#2 Strike & Turn type bit (DBZ-52)
- Rubber Sleeve for DBZ-52

PRODUCT VIDEO

Handle grip



DBZ-51



DBZ-52

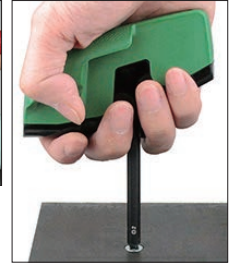

| Item No. | Material | Wgt. |
|----------|------------------------------------------------------|------|
| DBZ-60G | Bit: Carbon Steel Sleeve: TPR Grip: ABS, Nylon | 135g |

DBZ-50B**HANDLE GRIP FOR DBZ(BLACK)**

High-torque handle grip



| Item No. | Material | Width | Wgt. |
|----------|------------------|-------|------|
| DBZ-50B | Grip: ABS, Nylon | 100mm | 83g |

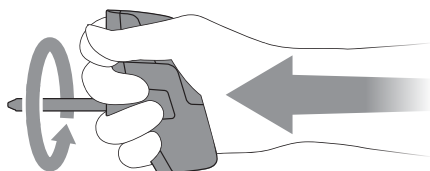



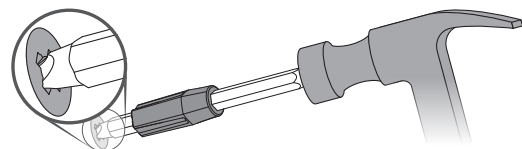









How to**Press & Twist type** (for slightly damaged screws)

- 1) Insert the bit into the handle grip.
- 2) Place the bit tip into the screw head, then scrape away burrs in the recess by twisting it back and forth lightly.
*Do not attempt to hit the bit with a hammer.
- 3) After you feel the bit tip catches the corner of recess, give a jerk counterclockwise while pressing firmly downward.

**Strike & Turn type** (for heavily damaged screws)

- 1) Clean out any steel chips left in the screw recess.
- 2) Fix the rubber sleeve to the Strike & Turn bit and position the tip in the recess.
- 3) Strike the end of the bit with a hammer to stick the tip into the recess.
- 4) Make sure the bit is self-standing upright, and then affix the grip onto the bit.
*Do not hit the grip with a hammer.
- 5) Give a jerk counterclockwise while pressing firmly downward.



| Press & Twist type | Strike & Turn type |
|--------------------------------------------------------------------------------------------------------------------------------------------------------------------------------------------------------------------------------------------------------------------------------------------------------------------------------------------------------------------------------------------------------------------------------------------------------------------------------------------------------------------------------|----------------------------------------------------------------------------------------------------------------------------------------------------------------------------------------------------------------------------------------------------------------------------------------------------------------------------------------------------------------------------------------------------------------------------------|
|  <p>Slightly damaged Philips screws</p> <p>■ DBZ-51</p>  <p>■ DBZ-57</p>  |  <p>Heavily damaged Philips screws</p> <p>■ DBZ-52</p>  |
|  <p>Slightly damaged Hex screws</p> <p>■ DBZ-62</p>  <p>■ DBZ-63</p>  <p>■ DBZ-64</p>  <p>■ DBZ-65</p>  |  <p>Heavily damaged Hex screws</p> <p>■ DBZ-53</p>  <p>■ DBZ-54</p>  <p>■ DBZ-56</p>  |











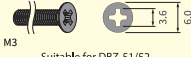

| Item No. | Screw type/size | Bit type | Length | Wgt. |
|----------|---------------------------------|--------------------|--------|------|
| DBZ-51 | ⊕#2 | Press & Twist type | 105mm | 27g |
| DBZ-52 | | Strike & Turn type | | |
| DBZ-53 | Hex socket screw (●: 2.5-3.0mm) | Strike & Turn type | | 26g |
| DBZ-54 | Hex socket screw (●: 4.0mm) | Strike & Turn type | | |
| DBZ-56 | Hex socket screw (●: 5.0mm) | Strike & Turn type | | |
| DBZ-57 | ⊕#1 | Press & Twist type | | 25g |
| DBZ-62 | Hex socket screw (●: 2.0mm) | Press & Twist type | | |
| DBZ-63 | Hex socket screw (●: 2.5-3.0mm) | Press & Twist type | | |
| DBZ-64 | Hex socket screw (●: 4.0mm) | Press & Twist type | | |
| DBZ-65 | Hex socket screw (●: 5.0mm) | Press & Twist type | | 27g |

PRODUCT VIDEO

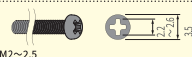

DBZ-62~65 can be used with your power driver

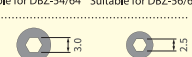
Screw types

| | | | |
|------------------------------------------------------------------------------------------------------------------------------------------------------------------------------------------------------------------------------------------------------------------------------------------------------------------------------------------------------------------------------------------------------------------------------------------------------------------------------|-----------------------------------------------------------------------------------------------------------------------------------------------------------------------------------------------------------------------------------------------------------------------------------------------------------------------------------------------------------------------------------------------------------------------------------------------------------------------------|---------------------------------------------------------------------------------------------------------------------------------------------------------------------------------------------------------------------------------------------------------------------------------------------------------------------------------------------------------------------------------|------------------------------------------------------------------------------------------------------------------------------------------------------------------------------------------------------------------------------------------------------------------------------------------------------------------------------------------------------------------------------------------|
| <p>Countersunk</p>  <p>M5</p>  <p>M4</p>  <p>M3</p> <p>Suitable for DBZ-51/52</p>  <p>M2~3</p> <p>Suitable for DBZ-57</p> | <p>Pan head</p>  <p>M5</p>  <p>M4</p>  <p>M3</p> <p>Suitable for DBZ-51/52</p>  <p>M2~2.5</p> <p>Suitable for DBZ-57</p> | <p>Dome head</p>  <p>M5</p>  <p>M4</p> <p>Suitable for DBZ-51/52</p>  <p>M2~3</p> <p>Suitable for DBZ-57</p> | <p>Hex</p>  <p>Suitable for DBZ-54/64</p>  <p>Suitable for DBZ-56/65</p>  <p>Cap bolt Counter sunk Button head</p> |
|------------------------------------------------------------------------------------------------------------------------------------------------------------------------------------------------------------------------------------------------------------------------------------------------------------------------------------------------------------------------------------------------------------------------------------------------------------------------------|-----------------------------------------------------------------------------------------------------------------------------------------------------------------------------------------------------------------------------------------------------------------------------------------------------------------------------------------------------------------------------------------------------------------------------------------------------------------------------|---------------------------------------------------------------------------------------------------------------------------------------------------------------------------------------------------------------------------------------------------------------------------------------------------------------------------------------------------------------------------------|------------------------------------------------------------------------------------------------------------------------------------------------------------------------------------------------------------------------------------------------------------------------------------------------------------------------------------------------------------------------------------------|

(Unit in mm)



Scissors

PH-57•PH-57R•PH-57G•PH-57Y

COMBINATION SCISSORS DP

- 2-in-1 anti-slip serrations and U-shaped blade
- 3mm-thick durable blades, made of stainless steel



Micro-serrations

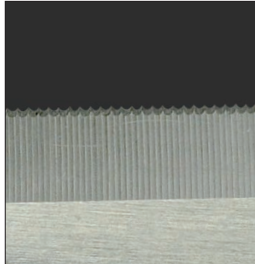

Hold the object without slippage such as Aramid fiber, plastic plate, etc.

U-shaped blade

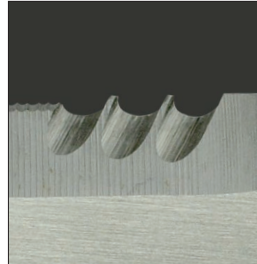

Ideal for power supply cord, coaxial cable, rope, etc.

TPR cushioned handles



Comfort gripping

Finger pinch guard



The overlapping guard prevents your fingers from being pinched **[PAT.]**

Cutting capacity (Reference only)

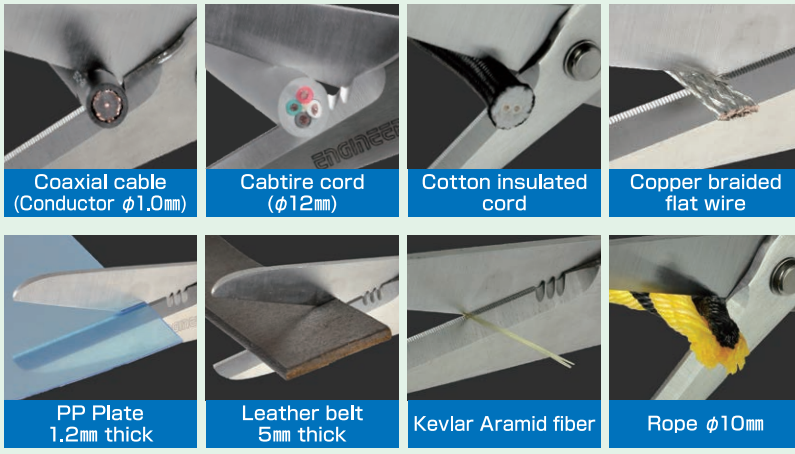

※Do not apply Copper or Steel wire to the Micro-serration to keep the life of main blades.
 ※Heat-treated or specially-hardened wire is not applicable for cutting. It may damage the blades.

Color variations

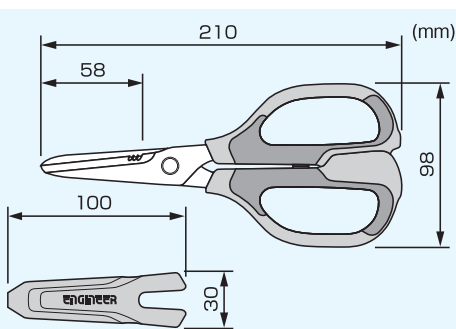

| Item No. | Size | Hardness | Material | Wgt. |
|----------|-------|----------|-------------------------|------|
| PH-57 | 210mm | HRC56±2 | Blades: Stainless Steel | 136g |
| PH-57R | | | Handles: ABS & TPR | |
| PH-57G | | | Cap: ABS | |
| PH-57Y | | | | |

SCREW REMOVAL

SCISSORS

NIPPERS

PLIERS

CRIMPING STRIPPING

TWEEZERS

SCREW DRIVERS

SPECIAL DRIVERS

WRENCHES

CUTTING PROCESSING

SETS CASES

SOLDERING EQUIPMENT

ESD CHEMICALS

PH-56R·PH-56G·PH-56Y

COMBINATION SCISSORS MP

- 2-in-1 anti-slip serrations and U-shaped blade
- 2.5mm-thick blades, made of stainless steel



Nano-serrations



Hold the object without slippage such as Aramid fiber, plastic plate, etc.

U-shaped blade

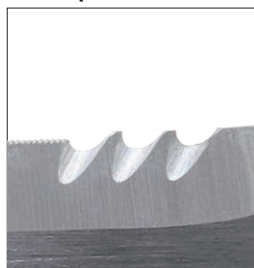

Ideal for power supply cord, coaxial cable, rope, etc.

Finger pinch guard

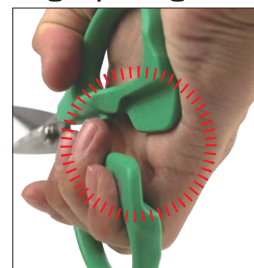

The overlapping guard prevents your fingers from being pinched **[PAT.]**

Cutting capacity (Reference only)

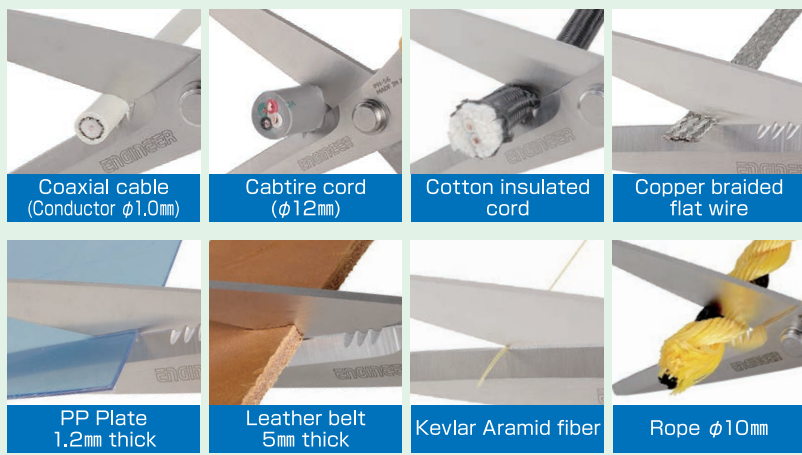

Color variations



※Do not apply Copper or Steel wire to the Micro-serration to keep the life of main blades.
 ※Heat-treated or specially-hardened wire is not applicable for cutting. It may damage the blades.

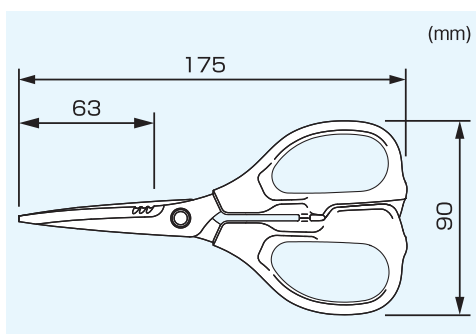

| Item No. | Size | Hardness | Material | Wgt. |
|----------|-------|----------|-----------------------------------------|------|
| PH-56R | 175mm | HRC56+2 | Blades: Stainless Steel Handles: ABS | 75g |
| PH-56G | | | | |
| PH-56Y | | | | |

PH-50

COMBINATION SCISSORS

2-in-1 Unique cutting blade

- Trimming various objects which you could not cut with ordinary scissors such as nylon fiber, cabtire cord, etc.
- Fine and flush cut in finish even compared with cut with cutting pliers
- Ideal for professional electricians as well as for hobby use.

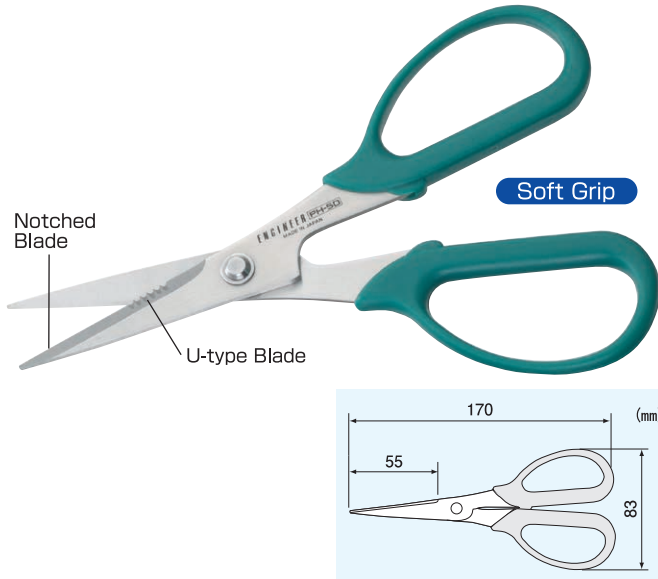

Notched Blade

Notched blades prevent the object from slipping



Trimming Nylon or Kevlar fiber without slipping



Copper braided flat wire



Aluminum sheet

PH-50 Notched Blade Cutting Capacity

| | |
|-----------------------|---------------|
| Nylon/Kevlar fiber | Various types |
| Copper braided wire | 0.5mm max. |
| Aluminum/Copper sheet | 1.0mm max. |
| Plastic plate / PET | 1.0mm max. |

U-type Blade



U-type notches hold cord firmly

Sharp cut against insulated cord with rubber or cotton braided



Cabtire cord



Copper wire

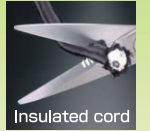

Insulated cord

PH-50 U-type Blade Cutting Capacity

| | |
|-----------------------|---------------|
| Copper wire | φ1.5mm max. |
| Cabtire cord | Various types |
| Cotton braided cord | |
| Cotton insulated cord | |

*Do not use U-type blade for cutting Aluminum or Copper sheet, which may damage the blade.

| Item No. | Size | Hardness | Material | Wgt. |
|----------|-------|----------|--------------------------------------|------|
| PH-50 | 170mm | HRC54±2 | Handles:PE Blades:Stainless Steel | 58g |

PH-55

COMBINATION SCISSORS GT

4-in-1 Blade combination, Compact Body to Generate More Force!!

- Cut various materials cleanly
- Safely-designed and comfortable handles
- Blade cap with vent & drain holes
- Rust proof stainless steel body
- Applicable to professional users and hobbyist

Anti-slip Handle



You can grasp the outer rim of the handles safely when the work requires a strong grip.



Micro-serration



Holds the object without slipping

Finger Pinch Guard



The overlapping guard prevents your fingers being pinched in the handles. **[PAT.]**

Flat Blade



Smooth cutting not only of cloth but also of paper



S-shaped Design



The unique form transmits gripping power efficiently to the shears.

Wire Cutter



Handy cutting blades for copper or steel wire

Safety Box Opener



Convenient to open carton boxes with ease

Cutting Capacity (Reference)

| Micro-serration | | Wire Cutter | |
|-----------------|--------------|------------------|-------------|
| Rope | Cabtire cord | Cotton insulated | Copper wire |
| | | | |
| φ10mm | φ9mm | φ8mm | φ1.6mm |
| Leather belt | CD-Card | Carpet | Wire |
| | | | |
| 4mm thick | 1.2mm thick | 5mm thick | φ1.2mm |

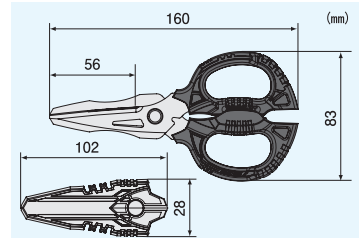

| Item No. | Size | Hardness | Material | Wgt. |
|----------|-------|----------|---------------------------------------|------|
| PH-55 | 160mm | HRC56±2 | Handles:PBT Blades:Stainless Steel | 120g |

*Do not apply Copper or Steel wire to the Micro-serration to keep the life of main blades.
*Heat-treated or specially-hardened wire is not applicable for cutting. It may damage the blades.

SCREW REMOVAL

SCISSORS

NIPPERS

PLIERS

CRIMPING STRIPPING

TWEEZERS

SCREW DRIVERS

SPECIAL DRIVERS

WRENCHES

CUTTING PROCESSING

SETS CASES

SOLDERING EQUIPMENT

ESD CHEMICALS

PH-33·34

RoHS ELECTRONIC SNIPS

- Ideal for delicate cutting for PCB related work.
- PH-33 (straight) / PH-34 (curved)
- Length: 145mm
- Material: Stainless Steel
- Serrated shears for anti-slipping



PK-50·51

RoHS CABLE SHEARS

- Makes a fine cut surface owing to the curved blades
- High leverage for easy operation

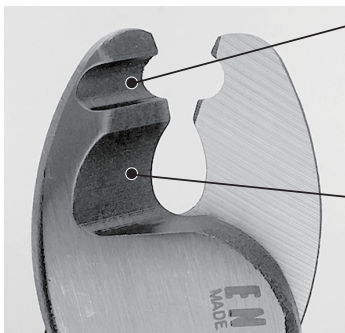
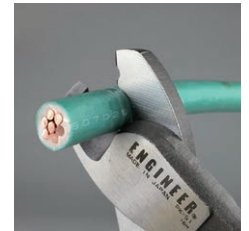

■ Foremost Blades
Wire cutter suitable for copper wires

■ Main Blade (Rearmost)
Curved blades suitable for insulated cables, make a fine cut surface. Flat cables, Coaxial cables, Power supply cords, LAN cables, etc. are also applicable.

Comparison of Cut Surface

Cable Shears

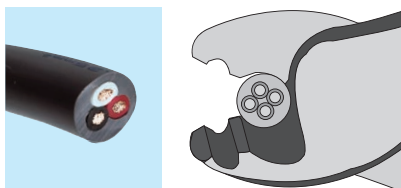

The curved blades can hold a cable securely and the shears mechanism enables you to make a cut surface finely.

Conventional Pliers

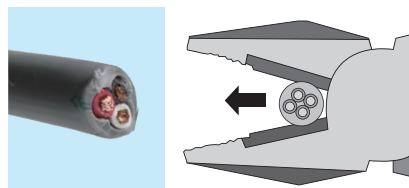

The pressure given from flat blades crushes a cable or it may slip sideways.



| Item No. | Size | Hardness | Cutting Capacity | | Wgt. |
|----------|-------|----------|-----------------------|-----------------------|------|
| | | | Vinyl insulated Cable | Flat Cable | |
| PK-50 | 164mm | HRC58±4 | 9mm outside diameter | 22 mil 2.0mm×2core | 150g |
| PK-51 | 212mm | HRC58±4 | 11mm outside diameter | 38 mil 2.0mm×3core | 250g |

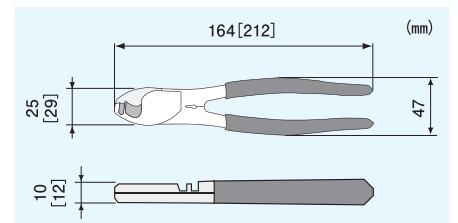

[]:PK-51

Nippers



NS & NZ SERIES

Features

- Our micro nippers are ideal for precise PCB work.
- Made of special steel and specially heat treated for excellent cutting capacity and durability.
- Full-flush cutting edge recommended for cutting copper and soft lead wires.
- Soft touch grip insulation and spring ensure long comfortable work.



- With opening angle adjuster or stopper

NS-03

RoHS MICRO NIPPERS

- Ideal for small PCB related work
- With opening angle adjuster
- Material: S58C
- Hardness: HRC 58±4
- Capacity: copper wire ϕ 1.4mm

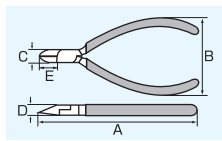

| Size | A | B | C | D | E |
|------|-----|----|----|---|----|
| 125 | 128 | 52 | 13 | 7 | 14 |

NS-04

RoHS MICRO NIPPERS

- Ideal for small PCB related work
- With opening angle adjuster
- ESD-Safe handles made of Elastomer (TPR)
- Material: S58C
- Hardness: HRC 58±4
- Capacity: copper wire ϕ 1.2mm

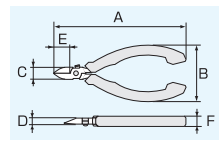

| Size | A | B | C | D | E | F |
|------|-----|----|----|---|----|----|
| 115 | 120 | 50 | 13 | 7 | 14 | 11 |

NSX-04

RoHS MICRO NIPPERS

- Cost-saving simple structure
- With side stopper
- Material: S58C
- Hardness: HRC 58±4
- Capacity: copper wire ϕ 1.2mm
- Especially for production line owing to economical and ecology package in poly bag

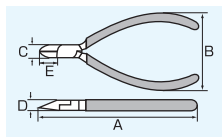

| Size | A | B | C | D | E |
|------|-----|----|----|---|----|
| 115 | 117 | 51 | 13 | 7 | 14 |

NS-06

RoHS MICRO NIPPERS

- Undercut design featuring thin blade
- Ideal for precise PCB related work
- With opening angle adjuster
- Material: S58C
- Hardness: HRC 58±4
- Capacity: copper wire ϕ 0.8mm

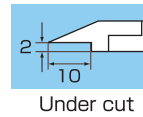

Under cut

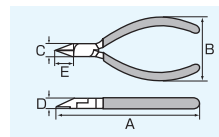

| Size | A | B | C | D | E |
|------|-----|----|----|---|----|
| 105 | 107 | 48 | 10 | 7 | 10 |

■ Nippers cutting capacities (Reference only)

| Item No. | Commodity | Size | Copper wire | | Steel wire (ϕ) | Others | Page |
|----------|--------------------|------|------------------|----------|-----------------------|------------------------------------|------|
| | | | Solid (ϕ) | Stranded | | | |
| NS-03 | Micro Nippers | 125 | 1.4 | 2 | | | 16 |
| NS-04 | Micro Nippers | 115 | 1.2 | 2 | | | 16 |
| NSX-04 | Micro Nippers | 115 | 1.2 | 2 | | | 16 |
| NS-06 | Micro Nippers | 105 | 0.8 | | | | 16 |
| NZ-03 | Chip Cutter | 125 | 0.6 | | | | 17 |
| NZ-05 | Chip Cutter | 125 | 0.6 | | | also applicable to plastic gate | 17 |
| NZ-12 | Parallel Nippers | 125 | 0.6 | | | | 17 |
| NZ-13 | Parallel Nippers | 125 | 0.6 | | | | 17 |
| NP-03 | Plastic Nippers | 125 | | | | Injection molding gate ϕ 3mm | 19 |
| NP-04 | Plastic Nippers | 150 | | | | Injection molding gate ϕ 3mm | 19 |
| NP-05 | Plastic Nippers | 115 | 0.8 | | | Injection molding gate ϕ 3mm | 19 |
| NK-15 | Diagonal Nippers | 125 | 2.6 | 2 | 1.5 | | 18 |
| NK-16 | Diagonal Nippers | 150 | 3 | 2 | 1.9 | | 18 |
| NK-25 | Diagonal Nippers | 125 | 2.6 | 2 | 1.5 | Stripping hole ϕ 1.2 & 1.6mm | 18 |
| NK-26 | Diagonal Nippers | 150 | 3 | 2 | 1.9 | Stripping hole ϕ 1.2 & 1.6mm | 18 |
| NK-36 | Diagonal Nippers | 150 | 3.2 | | 2 | Vinyl insulated cable ϕ 1.6mm | 18 |
| NN-45 | Slant Edge Nippers | 125 | 2 | 2 | 1.2 | Stripping hole ϕ 1.2 & 1.6mm | 19 |
| NN-46 | Slant Edge Nippers | 150 | 2.6 | 2 | 1.4 | Stripping hole ϕ 1.2 & 1.6mm | 19 |
| NN-56 | Slant Edge Nippers | 150 | 2.6 | 2 | 1.4 | | 19 |

NZ-03

iRoHS CHIP CUTTER

- Opening angle adjuster (Max. 5mm) with 1.5mm hex key wrench included
- Sharp & slender design of jaws for work on dense circuit board
- ESD-Safe handles made of Elastomer (TPR)
- Material: S58C
- Hardness: HRC 58±4
- Capacity: copper wire $\phi 0.6\text{mm}$
- Applications: Removal of chip resistance, IC, etc. on SMD

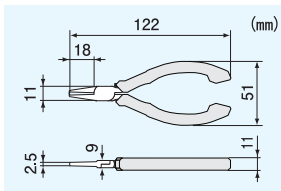

NZ-05

iRoHS CHIP CUTTER

- Opening angle adjuster (Max. 5mm) with 1.5mm hex key wrench included
- Sharp & slender design of jaws for work on dense circuit board
- ESD-Safe handles made of Elastomer (TPR)
- Material: S58C
- Hardness: HRC 58±4
- Capacity: copper wire $\phi 0.6\text{mm}$
- Applications: Leads of Dual In-line Package or Single In-line Package IC on SMD

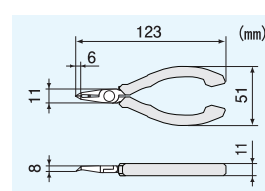

NZ-12·13

iRoHS PARALLEL NIPPERS

Full flush & super-fine cutting edge

- Ideal to cut an IC lead of a narrow-pitch QFP or SOP with slender shears (0.3mm+0.3mm width at top)
- Ergonomic elastomer handle for comfort gripping
- Cutting capacity : Copper wire $\phi 0.6\text{mm}$
- Light weight of 45g only

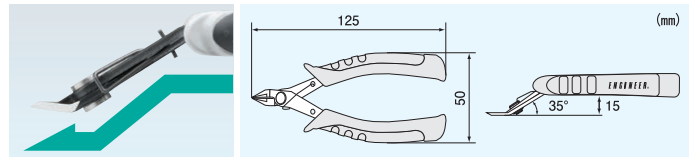

SHEARS & GRIP IN PARALLEL



NZ-12



NZ-13

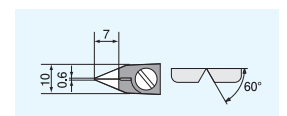
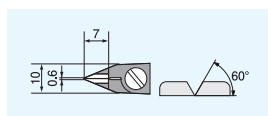

NZ-12 : Normal Blade
Enables you to make flush cut of a lead easily so as to prevent resist stripping or solder crack on the circuit board



NZ-13 : Reverse Blade
Enables you to cut IC lead in front of user with the best view while holding nippers vertically against circuit board

SCREW REMOVAL

SCISSORS

NIPPERS

PLIERS

CRIMPING STRIPPING

TWEEZERS

SCREW DRIVERS

SPECIAL DRIVERS

WRENCHES

CUTTING PROCESSING

SETS CASES

SOLDERING EQUIPMENT

ESD CHEMICALS

NK-15·16



DIAGONAL NIPPERS

Sharp & durable cutting for precision wiring work

- With opening angle adjuster & coiled spring
- Material: S55C
- Hardness: HRC 58±4
- Capacity (copper wire) : NK-15 ϕ 2.6mm
NK-16 ϕ 3mm

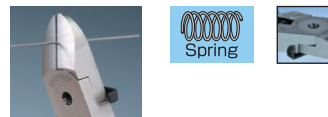

NK-15

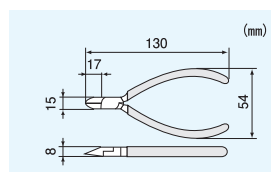

NK-16

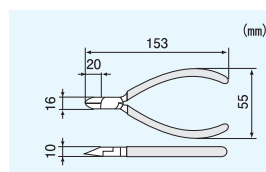

NK-25·26



DIAGONAL NIPPERS

Precision cutter with wire stripper

- With opening angle adjuster & coiled spring
- Stripping holes: ϕ 1.2 & 1.6mm
- Material: S55C
- Hardness: HRC 58±4
- Capacity (copper wire) : NK-25 ϕ 2.6mm
NK-26 ϕ 3mm

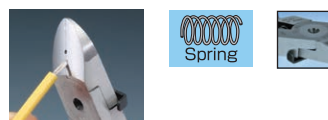

NK-25

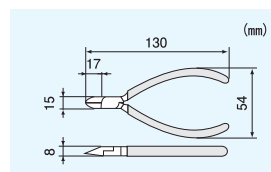

NK-26

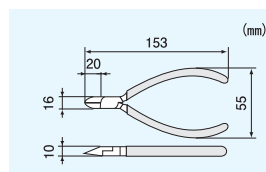

NK-36



HEAVY DUTY DIAGONAL NIPPERS

Heavy-duty durable cutter

- Material: S58C
- Hardness: HRC 60±4
- Capacity: copper wire ϕ 3.2mm

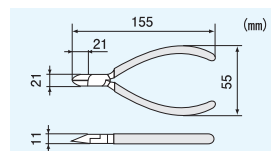

NN-45·46  **SLANT EDGE NIPPERS**

Professional type for sharp & easy use 

- Stripping holes: ϕ 1.2 & 1.6mm
- Material: S58C
- Hardness: HRC 58 \pm 4

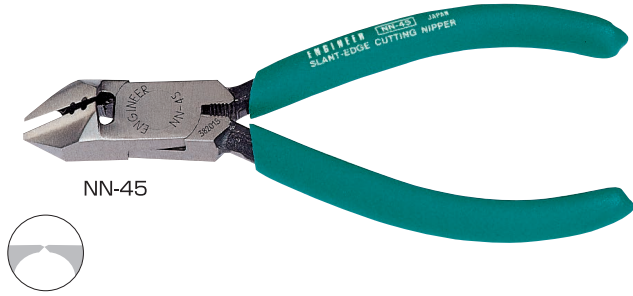

NN-45

| Item No. | Size | A | B | C | D | E | Capacity |
|----------|------|-----|----|----|----|----|--------------------------|
| NN-45 | 125 | 133 | 51 | 14 | 10 | 23 | copper wire ϕ 2mm |
| NN-46 | 150 | 159 | 51 | 16 | 11 | 26 | copper wire ϕ 2.6mm |

(mm)

NN-56  **SLANT EDGE NIPPERS**

Sharp cutting & easy handling 

- Material : S58C
- Hardness : HRC 58 \pm 4
- Capacity : copper wire ϕ 2.6mm

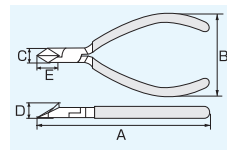

| Size | A | B | C | D | E |
|------|-----|----|----|----|----|
| 150 | 159 | 51 | 16 | 11 | 26 |

(mm)

NP-03·04  **PLASTIC NIPPERS**

- Ideal for cutting plastic mold gates & burns
- With opening angle adjuster & coiled spring
- Material: S58C
- Hardness: HRC 58 \pm 4

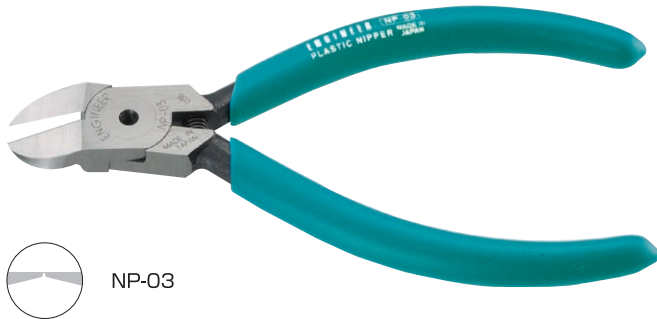

NP-03



NP-04

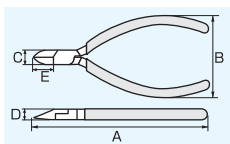

| Item No. | Size | A | B | C | D | E |
|----------|------|-----|----|----|----|----|
| NP-03 | 125 | 130 | 54 | 14 | 8 | 17 |
| NP-04 | 150 | 152 | 55 | 16 | 10 | 20 |

(mm)

NP-05  **PLASTIC NIPPERS**

Tapered and slender head for work in restricted area

- Ideal for cutting and trimming various gates of injection molding
- Also capable of cutting thin copper wire (ϕ 0.8mm max.)
- ESD-Safe handles made of Elastomer (TPR)
- With side stopper & coiled spring
- Material: S58C
- Hardness: HRC 59 \pm 3



NP-05

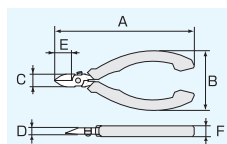

| Item No. | Size | A | B | C | D | E | F |
|----------|------|-----|----|----|---|----|----|
| NP-05 | 115 | 123 | 52 | 11 | 7 | 12 | 11 |

(mm)

SCREW REMOVAL

SCISSORS

NIPPERS

PLIERS

CRIMPING STRIPPING

TWEEZERS

SCREW DRIVERS

SPECIAL DRIVERS

WRENCHES

CUTTING PROCESSING

SETS CASES

SOLDERING EQUIPMENT

ESD CHEMICALS

Pliers



PS-01

 MINIATURE LONG NOSE PLIERS

Ideal for precision work

- Jaws with inside serration
- Material: S58C
- Hardness: HRC 58±4
- Capacity: copper wire ϕ 2mm

Point section

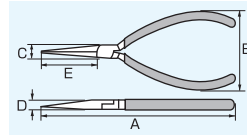
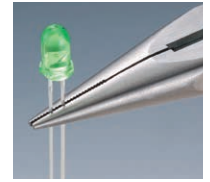

| Item No. | Size | A | B | C | D | E |
|----------|------|-----|----|----|---|----|
| PS-01 | 125 | 132 | 51 | 14 | 8 | 37 |

SCREW REMOVAL

SCISSORS

NIPPERS

PLIERS

PS-03

 MINIATURE NEEDLE NOSE PLIERS

Ideal for forming work

- Jaws without serration
- ESD-Safe handles made of Elastomer (TPR)
- Material: S58C
- Hardness: HRC 46±4



Point section



CRIMPING STRIPPING

TWEEZERS

SCREW DRIVERS

SPECIAL DRIVERS

PS-04

 MINIATURE FLAT NOSE PLIERS

- Jaws without serration
- ESD-Safe handles made of Elastomer (TPR)
- Material: S58C
- Hardness: HRC 46±4



Point section

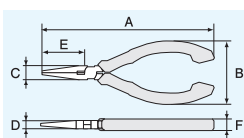
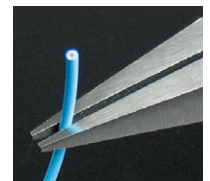

| Item No. | Size | A | B | C | D | E | F |
|----------|------|-----|----|----|---|----|----|
| PS-03 | 125 | 141 | 55 | 11 | 8 | 38 | 11 |
| PS-04 | 125 | 132 | 50 | 11 | 8 | 29 | 11 |

WRENCHES

CUTTING PROCESSING

SETS CASES

SOLDERING EQUIPMENT

ESD CHEMICALS

PL-05 · 06  **LONG FLAT NOSE PLIERS**

Thin and flat edge for efficient work

- Jaws without serration
- Long-life box joint structure to avoid loosening
- Material: Stainless steel

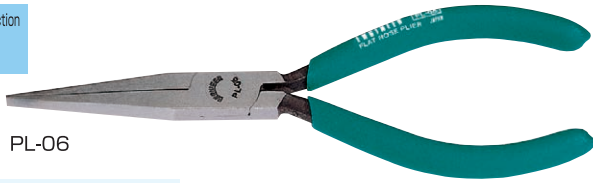

PL-06

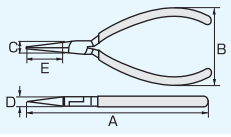

| Item No. | SIZE | A | B | C | D | E |
|----------|------|-----|----|----|----|----|
| PL-05 | 125 | 143 | 50 | 11 | 7 | 40 |
| PL-06 | 150 | 164 | 53 | 15 | 10 | 43 |

PM-06  **ROUND NOSE PLIERS**

Ideal for looping & coiling of steel wires

- Material: SCM440H

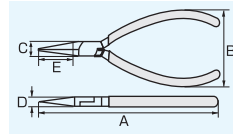
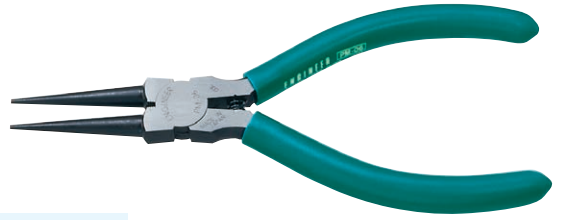

| SIZE | A | B | C | D | E |
|------|-----|----|----|---|----|
| 150 | 145 | 53 | 15 | 8 | 35 |

PR-15 · 16  **LONG NOSE PLIERS**

General purpose pliers



- Material: S58C
- Hardness: HRC 58±4

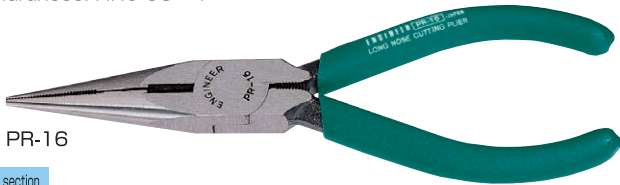

PR-16



| Item No. | SIZE | A | B | C | D | E | Capacity |
|----------|------|-----|----|----|----|----|--------------------------|
| PR-15 | 125 | 142 | 51 | 17 | 10 | 43 | Copper wire ϕ 2.0mm |
| PR-16 | 150 | 160 | 55 | 17 | 10 | 49 | Copper wire ϕ 2.6mm |

PR-26  **LONG NOSE PLIERS**

Professional type pliers



- Material: S58C
- Hardness: HRC 58±4
- Capacity: copper wire ϕ 2.6mm

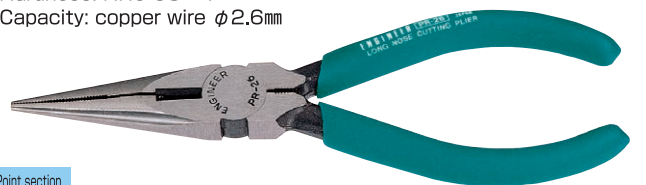

| SIZE | A | B | C | D | E |
|------|-----|----|----|----|----|
| 150 | 160 | 52 | 17 | 10 | 50 |

PR-36  **LONG NOSE PLIERS**

Multipurpose pliers with gripping jaws, cutter & wire stripper



- Stripping Hole: ϕ 1.2mm
- Material: S58C
- Hardness: HRC 58±4
- Capacity: copper wire ϕ 2.6mm

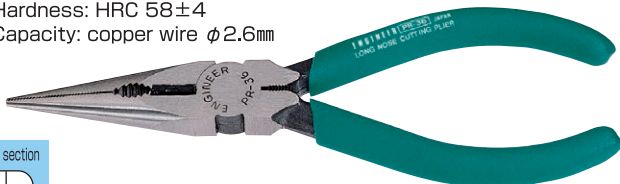

| SIZE | A | B | C | D | E |
|------|-----|----|----|----|----|
| 150 | 160 | 51 | 17 | 10 | 50 |

PR-46  **NEEDLE NOSE PLIERS**

50mm-long slender nose ideal for work in deep area

- Material: S58C
- Hardness: HRC 58±4
- Capacity: copper wire ϕ 2.6mm

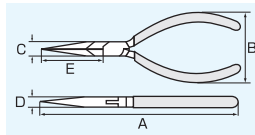

| SIZE | A | B | C | D | E |
|------|-----|----|----|---|----|
| 160 | 160 | 51 | 13 | 8 | 50 |

PD SERIES

Features ● Durably constructed Electrician's Pliers

PD-06~08

 **SIDE CUTTING PLIERS**

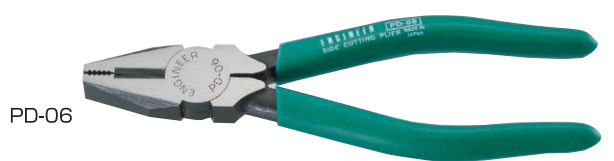

PD-06



PD-07



Heavy duty professional-use pliers

- Material: S58C
- Hardness: HRC 60±4

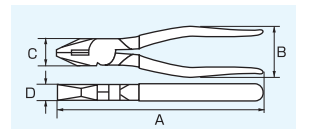

| Item No. | Size | A | B | C | D | Capacity |
|----------|------|-----|----|----|----|-----------------------|
| PD-06 | 150 | 165 | 50 | 22 | 12 | steel wire ϕ 1.6 |
| PD-07 | 175 | 185 | 52 | 24 | 13 | steel wire ϕ 1.8 |
| PD-08 | 200 | 210 | 53 | 27 | 14 | steel wire ϕ 2.0 |

PC & PW SERIES

Features ● Slip Joint Pliers and Groove Joint Pliers for maintenance and general purpose

PC-06·08 COMBINATION PLIERS

- Slip joint for wide-open jaws
- Material: S55C



PC-06



PC-08

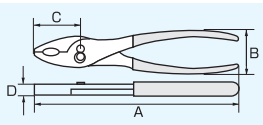

| Item No. | Size | A | B | C | D | (mm) |
|----------|------|-----|----|----|----|------|
| PC-06 | 150 | 165 | 45 | 42 | 9 | |
| PC-08 | 200 | 203 | 48 | 46 | 11 | |

PW-05~10 WATER PUMP PLIERS

- Groove-joint leverage for heavy duty work
- Serrated jaws with soft-touch grip
- Material: S55C



PW-05



PW-08

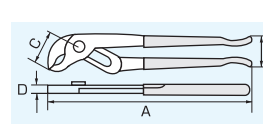

| Item No. | Size | A | B | C | D | Max. Opening | (mm) |
|----------|------|-----|----|----|-----|--------------|------|
| PW-05 | 125 | 127 | 34 | 25 | 5.5 | 15 | |
| PW-08 | 200 | 200 | 37 | 38 | 8 | 33 | |
| PW-10 | 250 | 250 | 38 | 50 | 11 | 45 | |

PZ-01·02

E-RING PLIERS

Ideal and smart pliers to remove and fasten E-ring!!

- Place the corner of E-ring into the recess of pliers' jaw for removal, fastening and replacement work.
- Magnetized point for convenient holding
- Long-life box joint structure to avoid loose joint
- Material : Stainless steel

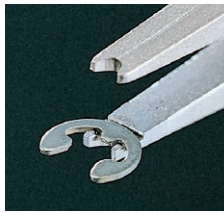
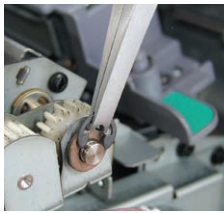

PZ-01

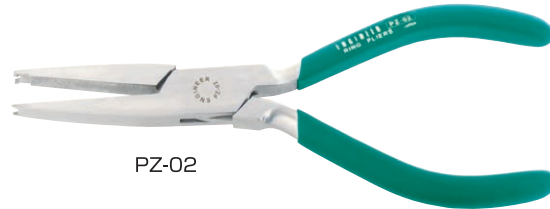

PZ-02



Box joint

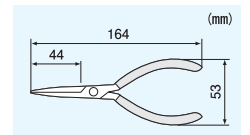
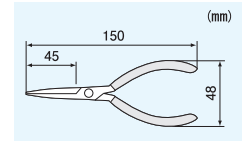

| Item No. | Ring Size | O.A. Length | (mm) |
|----------|-----------|-------------|------|
| PZ-01 | φ3~4 | 150 | |
| PZ-02 | φ5~9 | 164 | |



Ring Size

The Ring Size shown above is the diameter of grooved shaft to which E-ring retains.

PZ-16~19

SNAP RING PLIERS

- Slender design of jaws ideal for work at a confined area
- The spiked tips are angled outward (PZ-16&17) or inward (PZ-18&19) to hold a snap ring securely without slippage.
- Spring built into the joint screw for smooth and repeated work
- Material: Carbon steel



PZ-16



PZ-18



External ring type



Internal ring type

| Item No. | Applicable Ring Size | Tip Diameter | Ring Type | Wgt. | (mm) |
|----------|----------------------|--------------|---------------|------|------|
| PZ-16 | #10-25mm | φ1.3mm | External ring | 90g | |
| PZ-17 | #19-60mm | φ1.8mm | | 175g | |
| PZ-18 | #10-25mm | φ1.1mm | Internal ring | 90g | |
| PZ-19 | #19-60mm | φ1.8mm | | 175g | |

SCREW REMOVAL

SCISSORS

NIPPERS

PLIERS

CRIMPING STRIPPING

TWEEZERS

SCREW DRIVERS

SPECIAL DRIVERS

WRENCHES

CUTTING PROCESSING

SETS CASES

SOLDERING EQUIPMENT

ESD CHEMICALS

Crimping and Stripping



WIRE PLIERS SERIES

Features ● General purpose & compact wire pliers used for crimping, stripping & cutting for precision wiring work.

PA-01

RoHS WIRE PLIERS

- Six-in-one multipurpose type.
- For bare, insulated terminals & splices (open barrels).
- O.A. length: 245mm.
- Weight: 250g

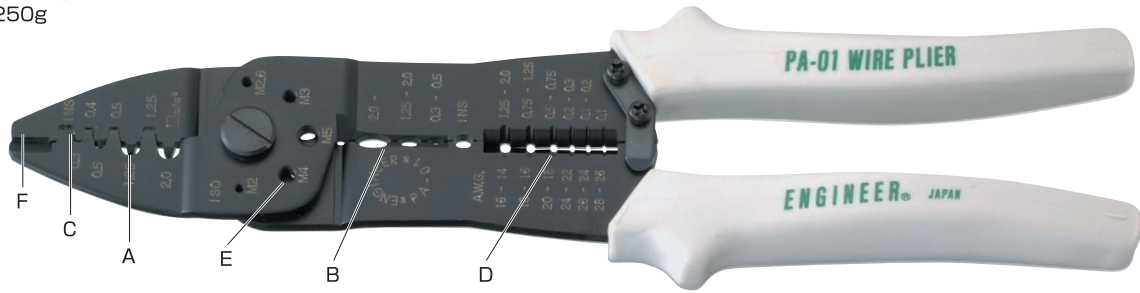

PA-03

RoHS WIRE PLIERS

- For splices (open barrel terminals) with wire stripper & bolt cutter.
- O.A. Length: 210mm.
- Weight: 205g

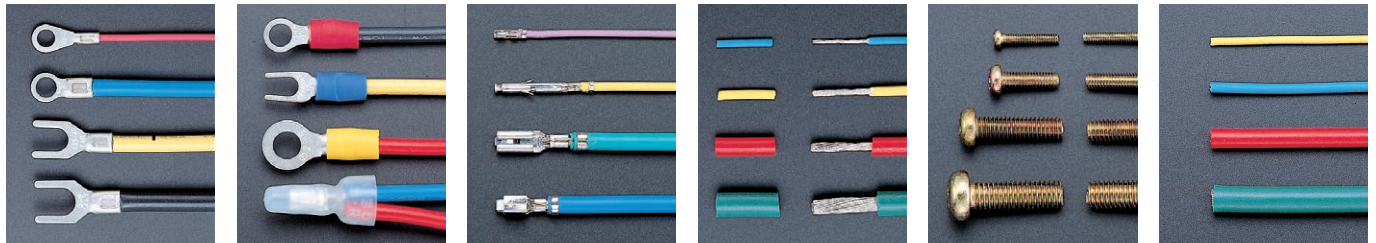
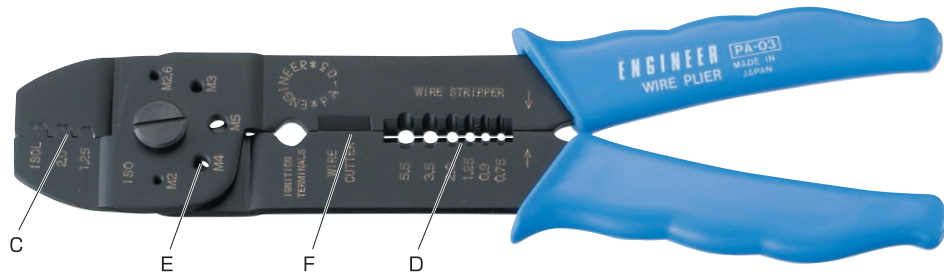

A. For crimping BARE terminals. B. For crimping INSULATED terminals. C. For crimping OPEN BARREL(SPLICES) D. For stripping insulated WIRES. E. For cutting SCREWS. F. For cutting WIRES.

| Item No. | (mm ²) | | | | | |
|----------|--------------------------------------|-------------------------------------------|--------------------------------|------------------------------|---------------------------------------------------|---------------------|
| | A | B | C | D | E | F |
| PA-01 | Bare terminals' crimping 0.5 ~2.0 | Insulated terminals' crimping 0.3 ~2.0 | Splices' crimping 0.3 ~1.25 | Wires' stripping 0.1 ~2.0 | Small screw's cutter(ISO) M2, M2.6, M3, M4, M5 | Wires' cutting ○ |
| PA-03 | - | - | 1.25~2.0 | 0.75~5.5 | M2, M2.6, M3, M4, M5 | ○ |

Conversion A.W.G. table

| AWG | 8 | 10 | 12 | 14 | 16 | 18 | 20 | 22 | 24 | 26 | 28 | 30 |
|--------------------------------|------|------|------|------|------|------|------|------|------|------|------|------|
| Sectional area mm ² | 8.37 | 5.26 | 3.31 | 2.08 | 1.31 | 0.82 | 0.52 | 0.33 | 0.20 | 0.13 | 0.08 | 0.05 |
| Wire diam mm | 3.26 | 2.59 | 2.05 | 1.63 | 1.29 | 1.02 | 0.81 | 0.64 | 0.51 | 0.40 | 0.32 | 0.25 |

How to select the proper dies for crimping an open-barrel contact

1. Measure the width of conductor barrel with a caliper while both barrel wings are in parallel.



2. Select the die width which is close to the width of barrel wings measured.

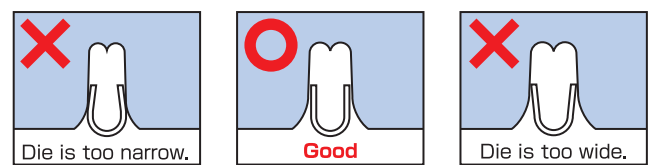

For example: 1.5mm measured → Select 1.6mm dies.

Turn to page 26 for Crimping Pliers →

SCREW REMOVAL

SCISSORS

NIPPERS

PLIERS

CRIMPING STRIPPING

TWEEZERS

SCREW DRIVERS

SPECIAL DRIVERS

WRENCHES

CUTTING PROCESSING

SETS CASES

SOLDERING EQUIPMENT

ESD CHEMICALS

CONNECTOR CRIMPING PLIERS

Features

- Our line-up offers you very precise and perfect crimp finish of open-barrel contacts.
- ENGINEER original joint-screw prevents the joint from being loose and realizes easy maintenance.
- Pliers made of S55C high carbon steel for durability
- With locking latch and coiled spring, Light weight for fatigue-free work

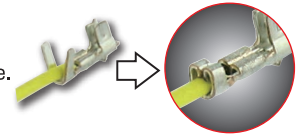

PA-09



MICRO CONNECTOR PLIERS

Crimp AWG #32 to #20 wires in micro connectors of different makers!!

- 4 different crimping dies, 1.0, 1.4, 1.6 & 1.9mm(W)
- Makes it possible to crimp 1.25 to 2.5mm pitch connector pin (Narrow pitch)
- D-sub connector contacts also adaptable
- Weight: 145 g



■ Typical terminals applicable

| | | |
|----------------|----------------|---------------------|
| PH Series(JST) | ZH Series(JST) | Molex 170363(Molex) |
| EH Series(JST) | NH Series(JST) | Molex 170365(Molex) |



■ Specifications

| Item No. | Die Width (mm) | Die Height (mm) | Die Thickness (mm) | Wires applicable (Reference only) | | |
|----------|----------------|-----------------|--------------------|-----------------------------------|------------|-----------------|
| | | | | φ mm | mm | AWG (conductor) |
| PA-09 | 1.0 | 0.50 | 1.7 | 0.20~0.32 | 0.031~0.08 | #32~#28 |
| | 1.4 | 0.55 | | 0.32~0.51 | 0.08~0.21 | #28~#24 |
| | 1.6 | 0.8 | 2.0 | 0.51~0.64 | 0.21~0.33 | #24~#22 |
| | 1.9 | 0.9 | | 0.51~0.81 | 0.21~0.52 | #24~#20 |

PA-20



UNIVERSAL CRIMPING PLIERS

Crimp AWG #28 to #18 wires in micro connectors of different makers!!

- 4 different crimping dies, 1.6, 1.9, 2.0 & 2.3mm(W)
- Makes it possible to crimp 2.5 to 5mm pitch connector pin (Universal type)
- Weight: 145 g



■ Typical terminals applicable

| | | |
|----------------|--------------------|------------------|
| VH Series(JST) | NH Series(JST) | PH Series(JST) |
| EL Series(JST) | 3191 Series(Molex) | MATE-N-LOK(Tyco) |



■ Specifications

| Item No. | Die Width (mm) | Die Height (mm) | Die Thickness (mm) | Wires applicable (Reference only) | | |
|----------|----------------|-----------------|--------------------|-----------------------------------|-----------|-----------------|
| | | | | φ mm | mm | AWG (conductor) |
| PA-20 | 1.6 | 0.7 | 2.5 | 0.32~0.64 | 0.08~0.33 | #28~#22 |
| | 1.9 | 0.8 | | 0.51~0.81 | 0.21~0.52 | #24~#20 |
| | 2.0 | 0.9 | | 0.64~1.02 | 0.33~0.82 | #22~#18 |
| | 2.3 | 1.0 | | 0.81~1.02 | 0.52~0.82 | #20~#18 |

PA-21



UNIVERSAL CRIMPING PLIERS

Precise crimpers for wide range of open-barrel contacts including long barrel wing type

- 4 different crimping dies, 1.6, 1.9, 2.2 & 2.5mm(W)
- Crimping AWG #26~18 contacts of different connector makers
- Weight: 145 g

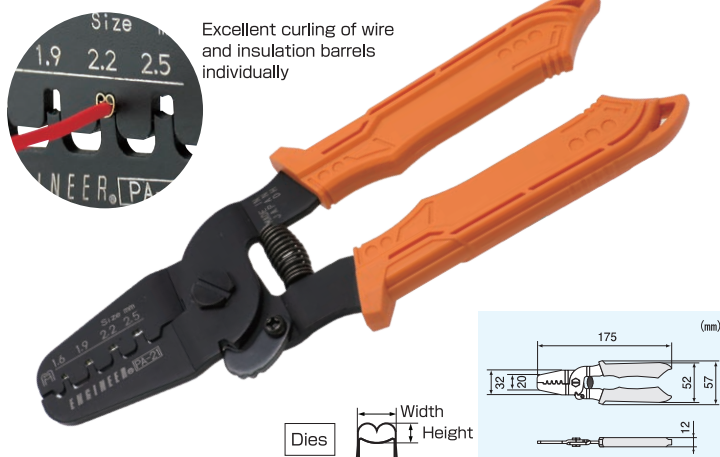

■ Typical terminals applicable

| | | |
|----------------|-----------------|----------------------------|
| XH Series(JST) | NH Series(JST) | VH Series(JST) |
| PA Series(JST) | Mini Fit(Molex) | Universal MATE-N-LOK(Tyco) |

■ Specifications

| Item No. | Die Width (mm) | Die Height (mm) | Die Thickness (mm) | Wires applicable (Reference only) | | |
|----------|----------------|-----------------|--------------------|-----------------------------------|-----------|-----------------|
| | | | | φ mm | mm | AWG (conductor) |
| PA-21 | 1.6 | 0.8 | 1.8 | 0.41~0.51 | 0.13~0.21 | #26~#24 |
| | 1.9 | 1.0 | | 0.41~0.64 | 0.13~0.33 | #26~#22 |
| | 2.2 | 1.2 | | 0.51~0.81 | 0.21~0.52 | #24~#20 |
| | 2.5 | 1.4 | | 0.64~1.02 | 0.33~0.82 | #22~#18 |

PRECISE CRIMPING SERIES - Tool Frame and Die Set

PAD-11~13

IRoHS HANDY CRIMP TOOL

Ultra-precise crimper forming excellent crimping finish

- Interchangeable die set for open-barrel contacts. Easy replacement and perfect fitting to the frame
- Ergonomically-designed handles with strap hole
- Equipped with wire stripper and cutter, spring loaded
- Standard accessory : Hex key wrench ● 2.5mm
- Material :
Frame & Die set – Special alloy steel
Handles – Elastomer (TPR)

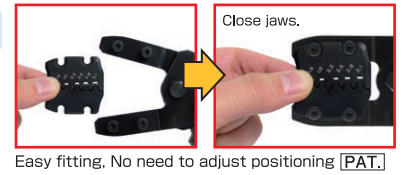

PAD-11 (S Size)

Loosen the cap screws with a hex key wrench to replace the die set.

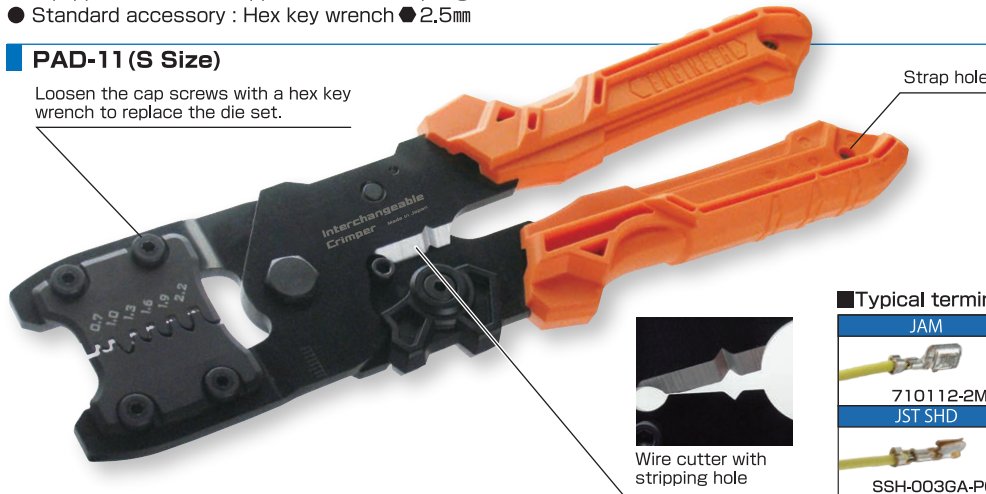

Typical terminals applicable

| JAM | Molex CLIK-Mate | Tyco D-1000 |
|----------------|-----------------|-------------|
| 710112-2MAC | 502381 | 1827586-2 |
| JST SHD | Molex PicoBlade | Tyco D-1000 |
| SSH-003GA-P0.2 | 50079 | 1827587-2 |

PAD-12 (M Size)



Typical terminals applicable

| JST NH | Molex New Mini Fit | Tyco D-3000 |
|----------------|--------------------|-------------|
| SHF-001T-0.8BS | 5556T | 175217-2 |
| JST VH | Molex New Mini Fit | Tyco D-3000 |
| SVH-21T-P1.1 | 5558T | 175288-2 |

PAD-13 (L Size)



Typical terminals applicable

| JST VL | Molex 3191 | Tyco D-3000 |
|--------------|------------|-------------|
| BVF-42T-P2.0 | 1189T | 175218-2 |
| JST VL | Molex 3191 | Tyco D-3000 |
| BVF-61T-P2.0 | 1190T | 175289-2 |

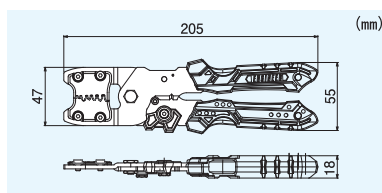

Crimper size

| Item No. | PAD-11 | | | | | | | | | | |
|---------------|--------|-----|-----|-----|-----|-----|--------|-----|-----|-----|-----|
| | PAD-12 | | | | | | PAD-13 | | | | |
| | PAD-13 | | | | | | | | | | |
| Die width | 0.7 | 1.0 | 1.3 | 1.6 | 1.9 | 2.2 | 2.5 | 2.8 | 3.1 | 3.4 | 3.7 |
| Die thickness | 1.0 | | 1.5 | | 2.0 | | 2.5 | | 3.0 | | 3.5 |

PAD-11S~13S

IRoHS INTERCHANGEABLE DIE SET

PAD-11S (S Size)

- Over 90 different terminals applicable



PAD-12S (M Size)

- Over 110 different terminals applicable



PAD-13S (L Size)

- Over 100 different terminals applicable

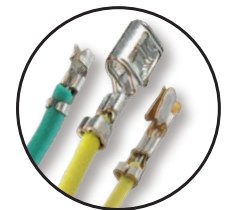

Frame & Dies Combination

| Item No. | Frame | Die set |
|----------|--------|-----------|
| PAD-11 | PAD-10 | + PAD-11S |
| PAD-12 | PAD-10 | + PAD-12S |
| PAD-13 | PAD-10 | + PAD-13S |

Crimper size

| Item No. | PAD-11S | | | | | | PAD-12S | | | | |
|---------------|-----------|-----|-----|-----|-----|-----|---------|-----|-----|-----|-----|
| | PAD-13S | | | | | | | | | | |
| | Die width | 0.7 | 1.0 | 1.3 | 1.6 | 1.9 | 2.2 | 2.5 | 2.8 | 3.1 | 3.4 |
| Die thickness | 1.0 | | 1.5 | | 2.0 | | 2.5 | | 3.0 | | 3.5 |

PAD-02  **HANDY CRIMP TOOL COMPLETE SET**

- Comes with 3 different interchangeable Die Sets
- Tool Frame & Parts Boxes in a stylish carrying case



■ Set Content

| Item No. | Description | |
|----------|--------------------------------------------------------|--------------|
| PAD-11 | Handy Crimp Tool | |
| PAD-12S | Interchangeable Die Set (M Size) | |
| PAD-13S | Interchangeable Die Set (L Size) | |
| | 2.5mm Hex. key wrench | |
| | Connectable parts box (6 pcs.) Ext. size:20×29×16mm | |
| | Carrying case (HDPE) | |
| (mm) | | |
| Item No. | Case Size | Wgt.(g) |
| PAD-02 | 300×200×63mm | 910g approx. |

PA-11

 **WIRE STRIPPER**

- Super-Light weight wire stripper
- Accurate wire stripping with single squeeze action.
- Fatigue-free owing to spring action
- Made of durable plastic



■ With strip gauge
Length of wire is adjustable using strip gauge.

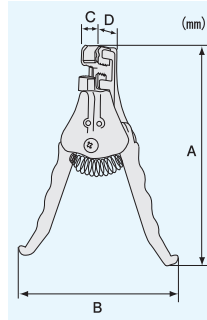

■ Size applicable

| Hole diameter mm | 0.5 | 1.2 | 1.6 | 2.0 | |
|--------------------|-----|-----|-----|-----|---------|
| Stranded wire(AWG) | 26 | 18 | 16 | 14 | |
| Solid wire AWG | 24 | 16 | 14 | 12 | |
| (mm) | | | | | |
| Item No. | A | B | C | D | Wgt.(g) |
| PA-11 | 165 | 128 | 20 | 30 | 140 |

PA-30  **WIRE STRIPPER**

- One-Squeeze operation for easy stripping of applicable flat cables, 12mm width max.
- With stopper for adjustment of stripping length, 2~20mm.
- Applicable sectional area: AWG20~10

- Sliding stopper to adjust length of stripping.

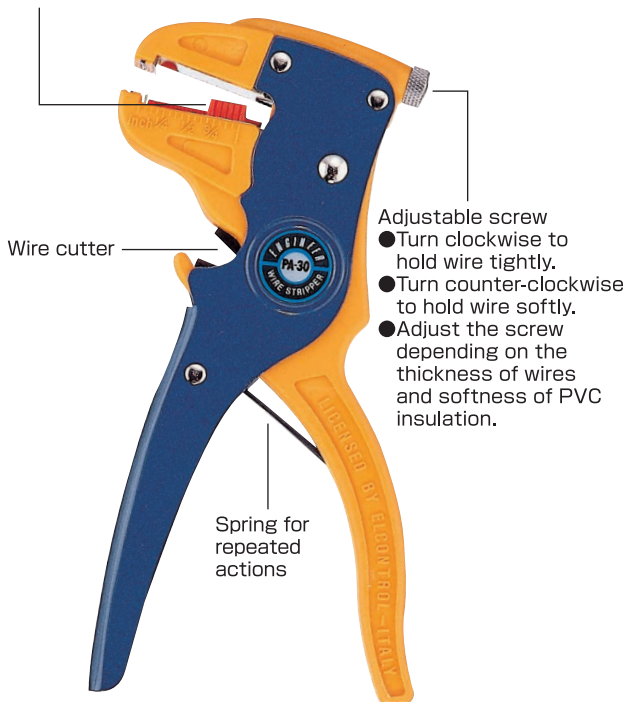



PA-91~93  **TERMINAL SET**

- Popular crimping terminals and connectors in compact plastic case.



■ PA-91 Set

| Terminal | Sectional area (mm ²) | Screw diam (mm) | Contents |
|-----------------------------------------------------------------------------------------|-----------------------------------------------------------------------------------------|-----------------|----------|
| Bare Terminal | R  | 0.5 | 3 |
| | | 1.25 | 3 |
| | | 1.25 | 4 |
| | | 2 | 5 |
| | | 5.5 | 6 |
| Y  | Y  | 1.25 | 4 |
| | | 2 | 5 |
| | | 5.5 | 6 |







■ PA-92 Set

| Terminal | Sectional area (mm ²) | Screw diam (mm) | Contents |
|--------------------|------------------------------------------------------------------------------------------|-----------------|----------|
| Insulated terminal | RV  | 1.25 | 3 |
| | | 1.25 | 4 |
| | | 2 | 5 |
| | | 1.25 | 3 |
| | | 1.25 | 4 |
| | | 2 | 5 |



■ PA-93 Set

| Terminal | Sectional area (mm ²) | Screw diam (mm) | Contents |
|--------------------|------------------------------------------------------------------------------------------|-----------------|----------|
| Insulated terminal | RV  | 5.5 | 6 |
| | YV  | 5.5 | 6 |
| Splice terminal | BC  | 1.25 | 8 |
| | | 2 | 8 |
| Twist connector | TC  | 1.25~2 | 10 |
| | | 1.5~4 | 8 |

PAS-30~34



CONNECTOR EXTRACTOR (Spring Loaded Type)

- Perfect and simple work for extracting pin & socket contacts
- Newly designed construction with built-in return spring
- Owing to built-in spring, ejector pin retracts in the sleeve after work. It prevents the ejector pin from being damaged while carrying or not in use.

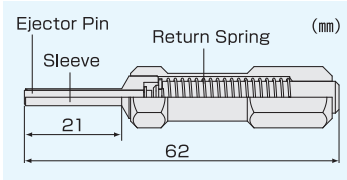

| Item No. | Inner Diam of Sleeve | Outer Diam of Sleeve | Material |
|----------|----------------------|----------------------|------------------------|
| PAS-30 | 1.9 | 2.5 | SUS303 Stainless Steel |
| PAS-31 | 2.1 | 2.7 | |
| PAS-32 | 2.4 | 2.9 | |
| PAS-33 | 3.1 | 3.6 | |
| PAS-34 | 2.7 | 3.2 | |

■ Reference for extracting typical connectors

| Brand/Connector | Pin Housing | Socket Housing |
|--------------------------------|-------------|----------------|
| "TE" Mini Universal Mate-N-Lok | PAS-30 | SS-30 |
| "TE" Universal Mate-N-Lok | PAS-34 | PAS-34 |
| "TE" Commercial Mate-N-Lok | PAS-32 | PAS-34 |
| "JST" ML & EL Series | PAS-31 | PAS-31 |
| "JST" L & LL Series | PAS-33 | PAS-33 |
| "MOLEX" 1545 Series | PAS-33 | PAS-34 |
| "MOLEX" 1625 Series | PAS-30 | PAS-31 |
| "MOLEX" 3191 Series | PAS-33 | PAS-33 |

SS-30~34



PIN EXTRACTOR

Perfect for extracting both pin and socket terminals.

- The ejector rod inside the sleeve enables you to knock out both male & female pin easily from socket terminal.

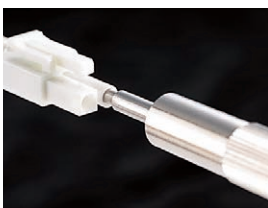
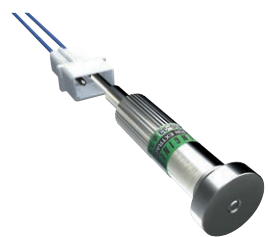

(Shape sizes)

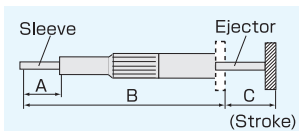

| Item No. | Outer Diam of Sleeve | Inner Diam of Sleeve | A | B | C |
|----------|----------------------|----------------------|----|----|----|
| SS-30 | 2.5 | 1.9 | 12 | 64 | 21 |
| SS-31 | 2.7 | 2.1 | | | |
| SS-32 | 2.9 | 2.4 | | | |
| SS-33 | 3.6 | 3.1 | | | |
| SS-34 | 3.2 | 2.7 | | | |

■ Reference for extracting typical connectors

| Brand/Connector | Pin Housing | Socket Housing |
|--------------------------------------------|-------------|----------------|
| "TYCO" Mini Universal Mate-N-Lok | SS-30 | SS-30 |
| "TYCO" Universal Mate-N-Lok | SS-34 | SS-34 |
| "TYCO" Commercial Mate-N-Lok | SS-32 | SS-34 |
| "JST" ML & EL Series | SS-31 | SS-31 |
| "JST" L & LL Series | SS-33 | SS-33 |
| "MOLEX" 1545 Series | SS-33 | SS-34 |
| "MOLEX" 1625 Series | SS-30 | SS-31 |
| "MOLEX" 3191 Series | SS-33 | SS-33 |
| "MOLEX" 8980 Series(4-pin connector in PC) | SS-32 | SS-34 |

SCREW REMOVAL
SCISSORS
NIPPERS
PLIERS
CRIMPING STRIPPING
TWEEZERS
SCREW DRIVERS
SPECIAL DRIVERS
WRENCHES
CUTTING PROCESSING
SETS CASES
SOLDERING EQUIPMENT
ESD CHEMICALS

PH-01~04

LOCK HOLDER

- Serrated ratchet allows quick disconnect & reconnect for temporary connection.
- Ideal for assembling, soldering & precision clamping work.
- Material: Stainless Steel



Holding component

Clipping oil hose



| (mm) | | |
|----------|--------|-------------|
| Item No. | Length | Point shape |
| PH-01 | 125 | Straight |
| PH-02 | | Curved |
| PH-03 | 150 | Straight |
| PH-04 | | Curved |

SS-21·22

SPRING HOOK

- Ideal for inserting, removing and adjusting coil springs of electronic components or precision instruments
- Suitable for removing connector leads, aligning leads of resistor or condenser and testing arrangements of wires
- 3mm diam.X215 O.A. length



SS-21

SS-22



SS-21



SS-22

TP-33·34

PICK-UP TOOL

- 4 spring jaws pick up small and ball bearing type parts easily and firmly.
- Suitable for assembly work of precision instruments.
- Ideal for pick-up work even in hard to reach areas.

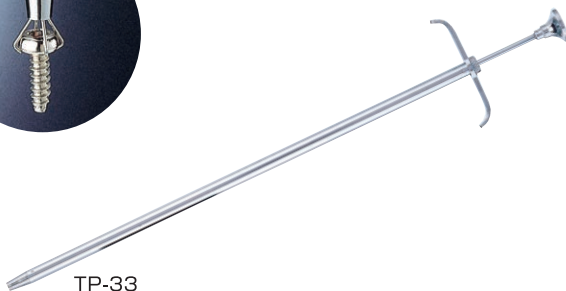

TP-33

| (mm) | | |
|----------|---------|-------------|
| Item No. | Housing | O.A. Length |
| TP-33 | φ6.2 | 250 |
| TP-34 | φ6.2 | 350 |

TP-35·36

MAGNETIC PICK-UP TOOL

- Ideal for part retrieval in hard to reach areas
- Flexible shaft conforms to any shape
- Alnico magnet tip

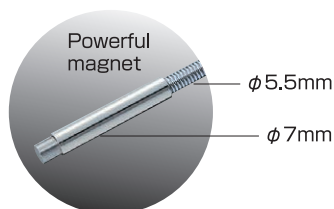

| (mm) | |
|----------|-------------|
| Item No. | O.A. Length |
| TP-35 | 410 |
| TP-36 | 525 |

PA-05·06·07·14

WIRE STRIPPER

- Giving a very round finish of wires after stripping by sharp and precise edge
- Made of carbon steel alloy withstanding abrasions
- Oil-resistant Elastomer (TPR) handle



Environment-friendly Elastomer handle

PA-14 for micro-thin wire

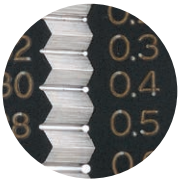

with strap hole

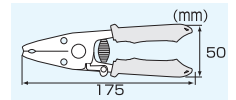

| Item No. | Wgt. |
|----------|------|
| PA-14 | 134g |

Applicable Sizes Table

| Stripper's Hole Diam(mm) | | 0.25 | 0.3 | 0.4 | 0.5 | 0.65 | 0.8 | 0.95 | |
|--------------------------|----------------|------------|-----|-----|-------|------|-----|-------|-------|
| Applicable wire | AWG conversion | Stranded | 34 | 32 | 28~30 | 26 | 24 | 22~24 | 20~22 |
| | | Solid wire | 32 | 30 | 28 | 26 | 24 | 22 | 20 |

() Reference

"ENGINEER" original Joint-Screw prevents the joint from being loose and offer you easy maintenance.

PA-05 for thin wire

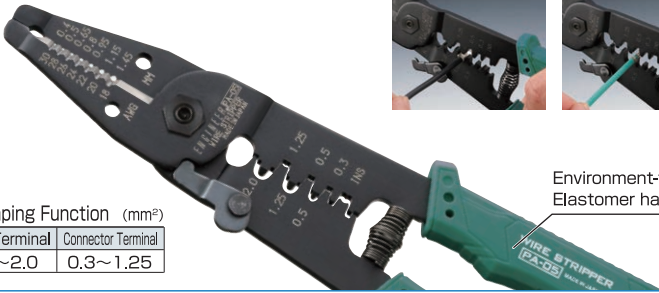

Environment-friendly Elastomer handle

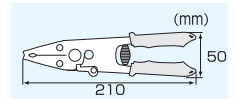

| Item No. | Wgt. |
|----------|------|
| PA-05 | 166g |

Applicable Sizes Table

| Stripper's Hole Diam(mm) | | 0.4 | 0.5 | 0.65 | 0.8 | 0.95 | 1.15 | 1.45 |
|--------------------------|----------------|------------|-------|-------|-----|-------|-------|---------|
| Applicable wire | AWG conversion | Stranded | 28~30 | 26~28 | 24 | 22~24 | 20~22 | 20 (18) |
| | | Solid wire | 28 | 26 | 24 | 22 | 20 | 18 |

() Reference

■Crimping Function (mm²)

| Bare Terminal | Connector Terminal |
|---------------|--------------------|
| 0.5~2.0 | 0.3~1.25 |

PA-06 for thin wire



Environment-friendly Elastomer handle

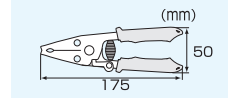

| Item No. | Wgt. |
|----------|------|
| PA-06 | 134g |

Applicable Sizes Table

| Stripper's Hole Diam(mm) | | 0.4 | 0.5 | 0.65 | 0.8 | 0.95 | 1.15 | 1.45 |
|--------------------------|----------------|------------|-------|------|-----|-------|-------|---------|
| Applicable wire | AWG conversion | Stranded | 28~30 | 26 | 24 | 22~24 | 20~22 | 20 (18) |
| | | Solid wire | 28 | 26 | 24 | 22 | 20 | 18 |

() Reference

PA-07 for thick wire



Environment-friendly Elastomer handle

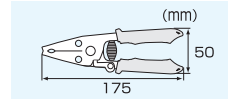

| Item No. | Wgt. |
|----------|------|
| PA-07 | 134g |

Applicable Sizes Table

| Stripper's Hole Diam(mm) | | 0.8 | 0.95 | 1.15 | 1.45 | 1.8 | 2.1 | 2.5 |
|--------------------------|----------------|------------|-------|-------|---------|------|-----|------|
| Applicable wire | AWG conversion | Stranded | 22~24 | 20~22 | 20 (18) | (16) | 14 | 12 |
| | | Solid wire | 22 | 20 | 18 | 16 | 14 | (12) |

() Reference

Wire Stripper AWG Conversion (Reference only)

| AWG | 34 | 32 | 30 | 28 | 26 | 24 | 22 | 20 | 18 | 16 | 14 | 12 |
|----------------------------|-------|-------|------|------|------|------|------|------|------|------|------|------|
| Stranded wire diameter(mm) | 0.19 | 0.23 | 0.29 | 0.37 | 0.47 | 0.59 | 0.74 | 0.94 | 1.18 | 1.49 | 1.88 | 2.37 |
| Conductor diameter(mm) | 0.16 | 0.2 | 0.25 | 0.32 | 0.40 | 0.51 | 0.64 | 0.81 | 1.02 | 1.29 | 1.63 | 2.05 |
| Sectional area(ml) | 0.025 | 0.032 | 0.05 | 0.08 | 0.13 | 0.2 | 0.33 | 0.52 | 0.82 | 1.31 | 2.08 | 3.31 |
| Stripping hole φ (mm) | PA-05 | | 0.4 | 0.5 | 0.65 | 0.8 | 0.95 | 1.15 | 1.45 | | | |
| | PA-06 | | 0.4 | 0.5 | 0.65 | 0.8 | 0.95 | 1.15 | 1.45 | | | |
| | PA-07 | | | | | 0.8 | 0.95 | 1.15 | 1.45 | 1.8 | 2.1 | 2.5 |
| | PA-14 | 0.25 | 0.3 | 0.4 | 0.5 | 0.65 | 0.8 | 0.95 | | | | |

PA-90 STRIP GAUGE

Min. stripping length 1mm!

- Saving time and giving you perfect stripping length every time
- Adjustable stripping length let you work more efficiently and reduces faults.

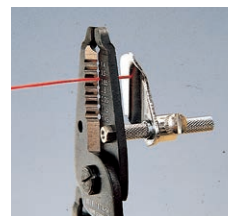

SCREW REMOVAL

SCISSORS

NIPPERS

PLIERS

CRIMPING STRIPPING

TWEEZERS

SCREW DRIVERS

SPECIAL DRIVERS

WRENCHES

CUTTING PROCESSING

SETS CASES

SOLDERING EQUIPMENT

ESD CHEMICALS

Tweezers



PT SERIES (AISI 304 Stainless Steel)

Features

- Standardized stainless steel (AISI 304), anti-magnetic, anti-acid & anti-corrosive alloy
- Hardened points are finished accurately and tensionized body to provide correct spring action & eliminate strain of fingers.
- Indicates spring action with

★ Soft ★★ Middle ★★★ Hard

PT-02 TWEEZERS (RR)

● Length : 150mm

★★



PT-04 TWEEZERS (I)

● Length : 120mm

★



PT-06 TWEEZERS (J)

● Length : 120mm

★



PT-08 TWEEZERS

● Length : 145mm

★



PT-10 TWEEZERS

- Serrated inside point
- Length : 150mm

★★



PT-01 TWEEZERS (AA)

● Length : 125mm

★



PT-03 TWEEZERS (MM)

● Length : 125mm

★



PT-05 TWEEZERS (GG)

● Length : 120mm

★



PT-07 TWEEZERS (TS)

- Serrated inside point
- Length : 125mm

★★



PT-09 TWEEZERS

- Serrated inside point
- Length : 130mm

★★



PT-11 TWEEZERS

- Serrated inside point
- Length : 230mm

★★



SCREW REMOVAL

SCISSORS

NIPPERS

PLIERS

CRIMPING STRIPPING

TWEEZERS

SCREW DRIVERS

SPECIAL DRIVERS

WRENCHES

CUTTING PROCESSING

SETS CASES

SOLDERING EQUIPMENT

ESD CHEMICALS

PT-12  **TWEEZERS (BS)**

●Length : 160mm



PT-13  **TWEEZERS**

●Length : 190mm

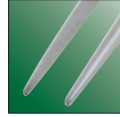

PT-14  **REVERSE ACTION TWEEZERS**

- Handles are squeezed to open points.
- Serrated inside points
- Length : 175mm

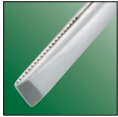

PT-15  **TWEEZERS**

- Inside polished points for picking up small sheets.
- Length : 105mm



SOLID ARM TWEEZERS SERIES

- Features
- 2.2mm thickly-designed arms hold IC chip more steadily than conventional tweezers.
 - Stiff arms can not bend easily and hold a small component very steadily.
 - AISI 304 anti-magnetic stainless steel

Arm Thickness:
1.5 times!!

PT-16

Conventional
tweezers



PT-16·17·31

 **SOLID ARM TWEEZERS**

- 0.5mm Fine tip
- Length:125mm



PT-16

- 1.3mm Squared tip
- Length: 125mm

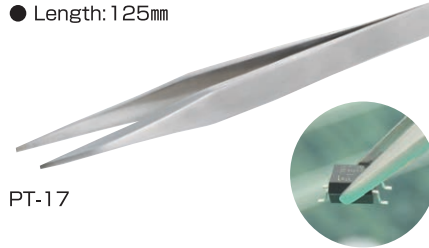

PT-17

- 0.3mm Fine tip (GG)
- Length:120mm

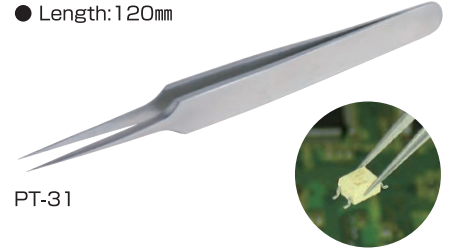

PT-31

TITANIUM TWEEZERS SERIES (100% ANTI-MAGNETIC)

- Features
- Perfect anti-magnetic titanium, safety in work of electronics and computer device. No solder residue left.
 - No corrosion, No rusting and Anti-ionization, ideal for chemical & biological fields

- Light weight, 40% less than ordinary stainless steel tweezers, for fatigue-free work

★ Soft ★★ Middle ★★★ Hard

PTN-01 TYPE AA  **TITANIUM TWEEZERS**

- Length : 125mm
- with soft case



General use tweezers with strong sharply pointed type.

with Soft Case **PTK-90**

PTN-02 TYPE GG  **TITANIUM TWEEZERS**

- Length : 120mm
- with soft case



Needle-like, very thin tips for handling microscopic parts.

with Soft Case **PTK-90**

PTN-03 TYPE J  **TITANIUM TWEEZERS**

- Length : 120mm
- with soft case



very thin and curved tips for working on microminiature assemblies.

with Soft Case **PTK-90**

ENGINEERING PLASTIC, PPS (Polyphenylenesulfide) TIP

- Features**
- ESD-Safe tip ideal for handling static sensitive components
 - Holding the object softly without any possibility of damage like metal tweezers
 - Totally anti-magnetic body including stainless steel shank
 - Anti-acid chemical resistance
 - High wear-resistant and replaceable tip
 - Heat resistance up to 270°C (ASTM D648)
- ※ The above is Deflection temperature and is not to guarantee performance of tip against heated object.

STATIC SAFE MILD CONTACT **SOFT SPRING ACTION**

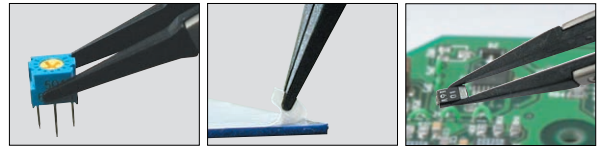

PTZ-41·42·43

ESD PLASTIC-TIPPED TWEEZERS



PTZ-41

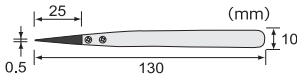

▲ Fine Tip PTZ-41

PTZ-42

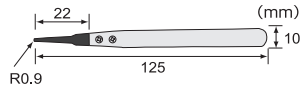

▲ Duckbill Tip PTZ-42

PTZ-43

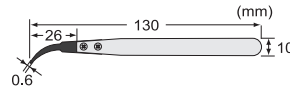

▲ Curved Nose (J) PTZ-43

PPS-TIPPED STAINLESS TWEEZERS

| Item No. | Overall Length | Tip | Shank Width | Wgt. |
|----------|----------------|-----------------|-------------|------|
| PTZ-41 | 130mm | 0.5mm Fine Tip | 10mm | 16g |
| PTZ-42 | 125mm | R0.9mm Duckbill | 10mm | 16g |
| PTZ-43 | 130mm | 0.6mm Fine Tip | 10mm | 16g |

PTZ-91

SPARE TIP FOR PTZ-41



Fine tip

■ Contents : tip 2 pcs. & screw 4 pcs./set

| Item No. | Material | Surface Resistivity |
|----------|----------|----------------------------------|
| PTZ-91 | PPS | $1 \times 10^5 \sim 10^7 \Omega$ |

PTZ-92

SPARE TIP FOR PTZ-42



Duckbill tip

■ Contents : tip 2 pcs. & screw 4 pcs./set

| Item No. | Material | Surface Resistivity |
|----------|----------|----------------------------------|
| PTZ-92 | PPS | $1 \times 10^5 \sim 10^7 \Omega$ |

PTZ-93

SPARE TIP FOR PTZ-43



■ Contents : tip 2 pcs. & screw 4 pcs./set

| Item No. | Material | Surface Resistivity |
|----------|----------|----------------------------------|
| PTZ-93 | PPS | $1 \times 10^5 \sim 10^7 \Omega$ |

PTZ-45·46

ESD PLASTIC TIPPED TWEEZERS

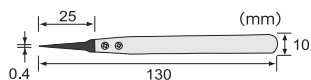

▲ Fine Tip PTZ-45

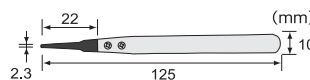

▲ Squared Tip PTZ-46

PPS-TIPPED STAINLESS TWEEZERS

| Item No. | Overall Length | Tip | Shank Width | Wgt. |
|----------|----------------|----------------|-------------|------|
| PTZ-45 | 130mm | 0.4mm Fine tip | 10mm | 16g |
| PTZ-46 | 125mm | 2.3mm Squared | 10mm | 16g |

PTZ-95

SPARE TIP FOR PTZ-45



Fine tip

■ Contents : tip 2 pcs. & screw 4 pcs./set

| Item No. | Material | Surface Resistivity |
|----------|----------|----------------------------------|
| PTZ-95 | PPS | $1 \times 10^5 \sim 10^7 \Omega$ |

PTZ-96

SPARE TIP FOR PTZ-46



Squared tip

■ Contents : tip 2 pcs. & screw 4 pcs./set

| Item No. | Material | Surface Resistivity |
|----------|----------|----------------------------------|
| PTZ-96 | PPS | $1 \times 10^5 \sim 10^7 \Omega$ |

SCREW REMOVAL

SCISSORS

NIPPERS

PLIERS

CRIMPING STRIPPING

TWEEZERS

SCREW DRIVERS

SPECIAL DRIVERS

WRENCHES

CUTTING PROCESSING

SETS CASES

SOLDERING EQUIPMENT

ESD CHEMICALS

PTZ-61~63

BLACK-COATED ESD TWEEZERS

Static dissipative black-coated tweezers

- ESD-safe body ideal for handling static sensitive components ($1 \times 10^5 \sim 10^9 \Omega$)
- Anti-magnetic and non-corrosive stainless steel body
- Non-slip and anti-glare rugged surface for easy handling

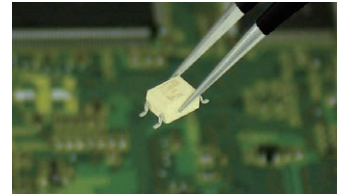

PTZ-61

▲ Fine tip PTZ-61

PTZ-62

▲ Duckbill tip PTZ-62

PTZ-63

▲ Type GG PTZ-63

| Item No. | Overall Length | Tip Length | Shank Width |
|----------|----------------|------------|-------------|
| PTZ-61 | 125 | 60 | 11 |
| PTZ-62 | 120 | 35 | 10 |
| PTZ-63 | 113 | 34 | 10 |

PTZ-51

CERAMIC-TIPPED TWEEZERS

High-temperature resistant ceramic tip featuring less solder adhesive

- Heat resistance : 1,000 °C (Tip)
- High wear-resistant and anti-acid tip
- Excellent electrical insulation
- Material : Anti-Magnetic stainless steel body with zirconia ceramic fine tip

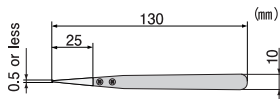

PTZ-94

SPARE TIP FOR PTZ-51



■ Contents : tip 2 pcs. & screw 4 pcs./set

PTS SERIES

Features ● Anti-corrosive stainless steel

PTS-01

TWEEZERS

- Straight AA type
- Length:125mm



PTS-03

TWEEZERS

- Curved with serrated inside
- Length:125mm



PTS-02·04~08

TWEEZERS

- Straight with serrated inside



| Item No. | Length(mm) |
|----------|------------|
| PTS-02 | 125 |
| PTS-04 | 150 |
| PTS-05 | 180 |
| PTS-06 | 210 |
| PTS-07 | 240 |
| PTS-08 | 300 |

Screwdrivers



DG-01~04



PRO GRIP DRIVER

- Soft grip handle provides excellent tightening power without slipping.
- Chrome-vanadium alloy steel, perfectly heat-treated gives it lasting durability.
- Black magnetic oxide tip.
- Chrome plated.



(mm)

| Item No. | Point Size | Shaft Length | Shaft diam. | Handle diam. | O.A. Length |
|----------|------------|--------------|-------------|--------------|-------------|
| DG-01 | ⊖5.5×0.7 | 80 | 5.5 | 28 | 200 |
| DG-02 | ⊕#1 | 80 | 5.5 | 28 | 200 |
| DG-03 | ⊖6.3×0.9 | 76 | 6.3 | 32 | 214 |
| DG-04 | ⊕#2 | 76 | 6.3 | 32 | 214 |

DG-05



CUSHION DRIVER

- ⊕/⊖ Two-in-one reversible blade.
- Comfortable soft-grip handle.
- Can also be used with electric and air drivers.



(mm)

| Item No. | Point Size | Shaft Length | Shaft diam. | Handle diam. | O.A. Length |
|----------|------------|--------------|-------------|--------------|-------------|
| DG-05 | ⊕#2/⊖6 | 95 | 6.3 | 34 | 210 |

DP-03~64



PRO-USE DRIVER

- Chrome Vanadium alloy steel & complete heat treated blade.
- Black oxide finish blade.
- Knurl shaft for quick rotation



Size table (mm)

| Item No. | Blade size | Shaft length | Shaft diam. | Handle diam. | O.A. Length |
|----------|------------|--------------|-------------|--------------|-------------|
| DP-03 | #00 | 75 | 3 | 15 | 146 |
| DP-24 | #0 | 100 | 4.3 | 18 | 183 |
| DP-44 | #1 | 100 | 5.5 | 25 | 200 |
| DP-64 | #2 | 100 | 6.3 | 27 | 213 |
| DP-13 | ⊖3.0×0.35 | 75 | 3 | 15 | 146 |
| DP-34 | ⊖4.3×0.5 | 100 | 4.3 | 18 | 183 |
| DP-54 | ⊖5.5×0.7 | 100 | 5.5 | 25 | 200 |

(Blade size=width×thickness)

DG-08·09



MASTER GRIP DRIVER

- Master Cushion grip assures powerful fastening power.
- Bottom marking & color distinguish phillips from slotted tip.
- Special alloy steel blade, tempered & plated for lasting durability.
- Precision black-point finish, magnetic point.



(mm)

| Item No. | Point Size | Shaft Length | Shaft diam. | Handle diam. | O.A. Length |
|----------|------------|--------------|-------------|--------------|-------------|
| DG-08 | ⊕#2 | 70 | 6.3 | 40 | 195 |
| DG-09 | ⊖6×1.0 | 70 | 6.3 | 40 | 195 |

DG-11~14



EXTRA LONG GRIP DRIVER

- Cushion grip handle which fits perfect in the hand provides excellent tightening power.
- Shafts are made of chrome vanadium alloy steel, entirely heat treated with black magnetic oxide tip.
- Chrome plated finish.



(mm)

| Item No. | Point Size | Shaft Length | Shaft diam. | Handle diam. | O.A. Length |
|----------|------------|--------------|-------------|--------------|-------------|
| DG-11 | ⊖6.0×0.8 | 225 | 6.3 | 32 | 362 |
| DG-12 | ⊕#2 | 225 | 6.3 | 32 | 362 |
| DG-13 | ⊖6.0×0.8 | 275 | 6.3 | 32 | 412 |
| DG-14 | ⊕#2 | 275 | 6.3 | 32 | 412 |

DS-03~64



STANDARD DRIVER



Size table for ⊕ driver (mm)

| Item No. | ⊕Blade size | Shaft length | Shaft diam. | Handle diam. | O.A. Length |
|----------|-------------|--------------|-------------|--------------|-------------|
| DS-03 | #00 | 75 | 3 | 11 | 128 |
| DS-23 | #0 | 75 | 4.3 | 16 | 151 |
| DS-24 | #0 | 100 | 4.3 | 16 | 176 |
| DS-44 | #1 | 100 | 5.5 | 18 | 185 |
| DS-46 | #1 | 150 | 5.5 | 18 | 235 |
| DS-64 | #2 | 100 | 6.3 | 22 | 193 |

Size table for ⊖ driver (mm)

| Item No. | ⊖Blade size | Shaft length | Shaft diam. | Handle diam. | O.A. Length |
|----------|-------------|--------------|-------------|--------------|-------------|
| DS-12 | 2.6×0.35 | 50 | 3 | 11 | 103 |
| DS-13 | 2.6×0.35 | 75 | 3 | 11 | 129 |
| DS-14 | 2.6×0.35 | 100 | 3 | 11 | 154 |
| DS-33 | 4.0×0.5 | 75 | 4.3 | 16 | 150 |
| DS-34 | 4.0×0.5 | 100 | 4.3 | 16 | 175 |
| DS-54 | 5.5×0.7 | 100 | 5.5 | 18 | 184 |

DG-21~24  **MINI SOFT DRIVER**

- Comfortable soft-grip handle.
- Chrome-vanadium steel & perfectly heat-treated blade.
- Black oxide point.
- Chrome plated finish.



| Item No. | Blade size | Shaft length | Shaft diam. | Handle diam. | O.A. Length |
|----------|------------|--------------|-------------|--------------|-------------|
| DG-21 | ⊖3×0.4 | 80 | 3 | 21 | 167 |
| DG-22 | ⊕#00 | 80 | 3 | 21 | 167 |
| DG-23 | ⊖4×0.5 | 80 | 4 | 21 | 167 |
| DG-24 | ⊕#0 | 80 | 4 | 21 | 167 |

DK-16  **MINI SOFT DRIVER SET**

- Contents
- DG-21
 - DG-22
 - DG-23
 - DG-24

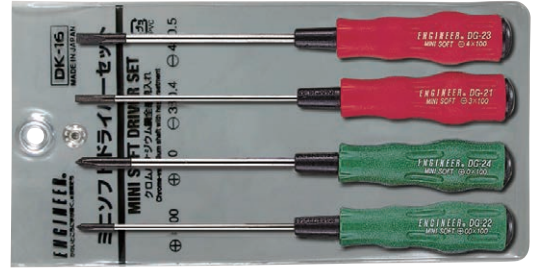

DST-01·02  **STUBBY DRIVER**



| Item No. | Tip size | Shaft length | Shaft diam. | Handle diam. | O.A. Length |
|----------|----------|--------------|-------------|--------------|-------------|
| DST-01 | ⊖6.3×0.9 | 38 | 6.3 | 30 | 86 |
| DST-02 | ⊕ #2 | 38 | 6.3 | 30 | 86 |

DST-05  **COMBINATION REVERSIBLE STUBBY DRIVER**

- 2-in-1 ⊕/⊖ reversible in single hand.
- Extra compact 85mm O.A. length.

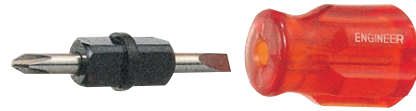

| Item No. | Tip size | Blade length | Blade diam. | Handle diam. | O.A. Length |
|----------|----------|--------------|-------------|--------------|-------------|
| DST-05 | ⊕#2/⊖6.3 | 23 | 6.3 | 30 | 85 |

DST-06·07  **MINIATURE REVERSIBLE DRIVER**

- 2-in-1 ⊕/⊖ reversible in single hand.
- Specially compact design in 42mm O.A. length.

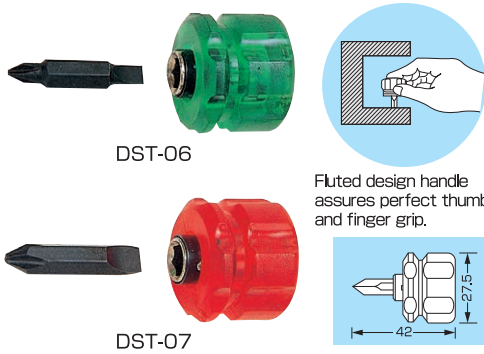

| Item No. | Tip size | Bit length | Bit diam. | Handle diam. |
|----------|----------|------------|-----------|--------------|
| DST-06 | ⊕#1/⊖4.5 | 16 | 6.3 | 27.5 |
| DST-07 | ⊕#2/⊖6 | 16 | 6.3 | 27.5 |

DK-50  **REVERSIBLE DRIVER SET**

- ⊕/⊖ Reversible type, 3pcs. set
- Contents: DK-51 ⊕#00/⊖2.6
DK-52 ⊕#1/⊖4.5
DK-53 ⊕#2/⊖6



DK-51~53  **REVERSIBLE DRIVER**

- ⊕/⊖ Two-in-one



| Item No. | Tip size | Blade length | Blade diam. | Handle diam. | O.A. Length |
|----------|-----------|--------------|-------------|--------------|-------------|
| DK-51 | ⊕#00/⊖2.6 | 67 | 3 | 18 | 164 |
| DK-52 | ⊕#1/⊖4.5 | 82 | 5 | 24 | 195 |
| DK-53 | ⊕#2/⊖6 | 89 | 6.3 | 26 | 216 |

DR-54  **STUBBY RATCHET DRIVER**

- Super compact stubby driver for hard-to-reach areas
- Improved efficiency due to the ratchet mechanism
- Magnet bit socket to attract and hold the bit firmly and securely in place



| Item No. | Bit size | Gear positions | Swing arc | Material | Wgt. |
|----------|----------|----------------|-----------|----------------------------------------|------|
| DR-54 | ⊕#2×25mm | 45 | 8 degrees | Handle: Aluminium Bit: Carbon steel | 50g |

DZ-01·02  **MINIATURE DRIVER**

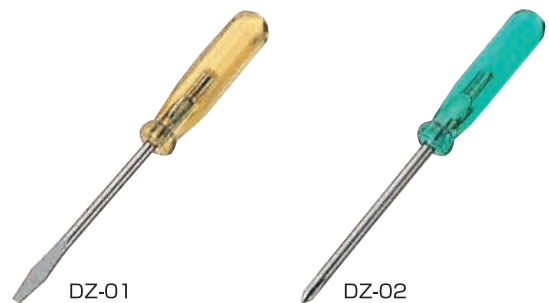

| Item No. | Point Size | Shaft Length | Shaft diam. | Grip diam. | O.A. Length |
|----------|------------|--------------|-------------|------------|-------------|
| DZ-01 | ⊖1.6×0.3 | 30 | 2 | 6.3 | 55 |
| DZ-02 | ⊕ #000 | 30 | 2 | 6.3 | 55 |

SCREW REMOVAL

SCISSORS

NIPPERS

PLIERS

CRIMPING STRIPPING

TWEEZERS

SCREW DRIVERS

SPECIAL DRIVERS

WRENCHES

CUTTING PROCESSING

SETS CASES

SOLDERING EQUIPMENT

ESD CHEMICALS

DR-52 MASTER GRIP DRIVER

Provides the most useful and popular magnetic bits.

- Tips also fit most rechargeable and electric drivers.
- Chrome-vanadium steel.
- Cushion grip handle.

Bullet-type bit holder for portable use.

Cushion grip



Bit set is separately available [DR-16](#)

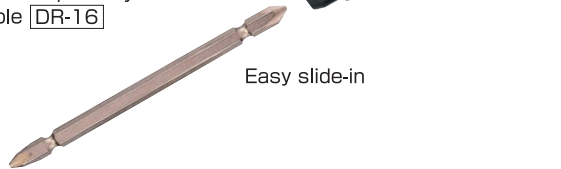

Easy slide-in

DR-07 TWIN WRENCH DRIVER SET

Designed for sure-gripped work in restricted areas.

- 10-in-1 combination of the most useful \oplus/\ominus tips.
- Knurled cushion handle fits the hand and the job.
- With portable bullet holder.
- Replacement bit sizes \oplus #00, #1, #2 \ominus 4.5, 6
- 1.5, 2, 2.5, 3, 4

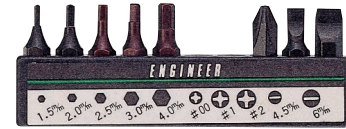

DR-03 RATCHET STUBBY DRIVER

- Compact 95mm O.A. length with a comfortable grip.
- Built-in ratchet mechanism.
- Replacement bits: \oplus #2/ \ominus 6mm, \oplus #1/ \ominus 4.5mm.
- Knurl shaft for quick rotation



DR-04 RATCHET STUBBY DRIVER SET

- Versatile driver with common replaceable \oplus/\ominus point bits.
- Built-in ratchet mechanism.
- Replacement set includes: \oplus #00, #1, #2, \ominus 4.5, 6
- 2.5, 3, 4, 5, 6
- Knurl shaft for quick rotation

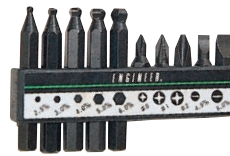

DR-08 RATCHET STUBBY DRIVER SET WITH FLEXIBLE SHAFT

Versatile flexible shaft makes difficult jobs easy

- 6-in-1 ratchet stubby type comes with most needed \oplus/\ominus , hex, box bits and flexible shaft.
- Easy access to tighten screws & nuts at hard-to-reach positions.
- Knurl shaft for quick rotation

Flexible shaft is designed to bend max. 75 degree in double construction. The piano wire is covered with flexible insulation.

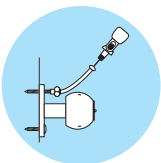

For use at hard-to-reach positions.



Flexible shaft is workable with rechargeable driver.

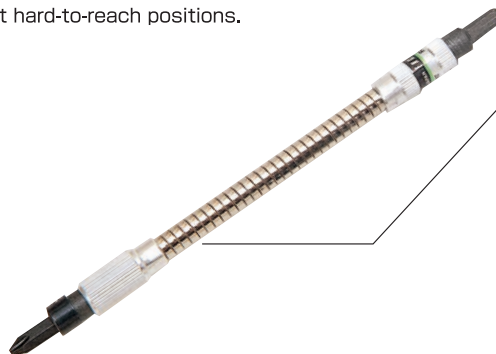

Bullet holder is clipped to belt or tool panel.

CONTENTS

- Ratchet stubby O.A.length: 80mm
- Flexible shaft O.A.length: 182mm
- \oplus/\ominus bit \oplus #2/ \ominus 6, \oplus #1/ \ominus 4.5
- Hex bit ● 2, 2.5, 3mm
- Box bit ● 5.5mm

DR-05 OFFSET RATCHET DRIVER

- Built-in quick ratchet mechanism increases work productivity.
- Designed to permit work in close areas that are inaccessible with ordinary drivers.
- Tip: \oplus #2/ \ominus 6mm

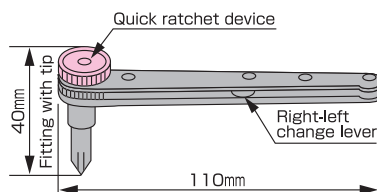
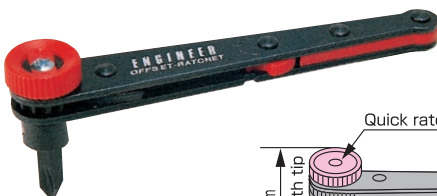

DR-06 OFFSET RATCHET DRIVER WITH BIT SET

Excellent for working in close areas!

- Versatile driver with most popular \oplus/\ominus & hex bits.
- Complete with handy bullet holder for carrying.
- Replacement set includes: \oplus #00, #1, #2, \ominus 4.5, 6
- 1.5, 2, 2.5, 3, 4
- Built-in quick ratchet device.

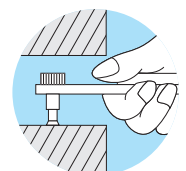
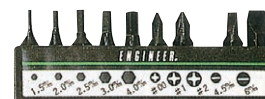
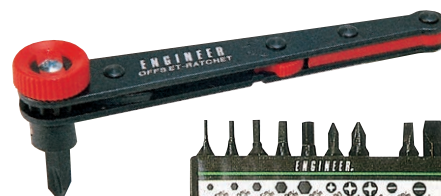

DR-55

RoHS MINI OFFSET RATCHET

Only 22mm-high low-profile head accessible to tight space !!

- Built-in quick ratchet device increases work productivity.
- Bit set includes : ⊕#1, #2, #3 & ⊖6mm

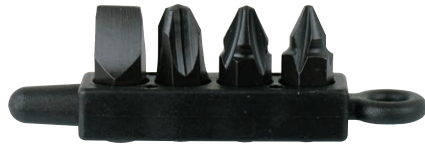
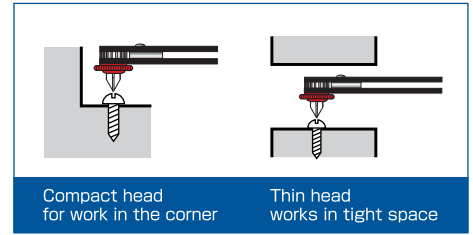

Super-thin Head 22mm

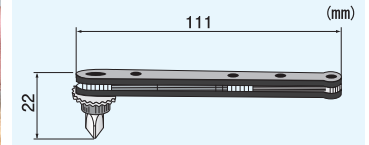

DR-56

RoHS 7-in-1 ANGLED RATCHET

- Ratchet handle with angled heads for ease of operation (Max. torque: 27.4 Nm)
- Use as a screwdriver (adaptor included) with a selection of 5 low-profile bits in a bullet holder.
- Bit adaptor accepts standard 6.35mm (1/4") hex bits.
- Low-profile head accessible to tight spaces
- ※ No socket is included in this product.

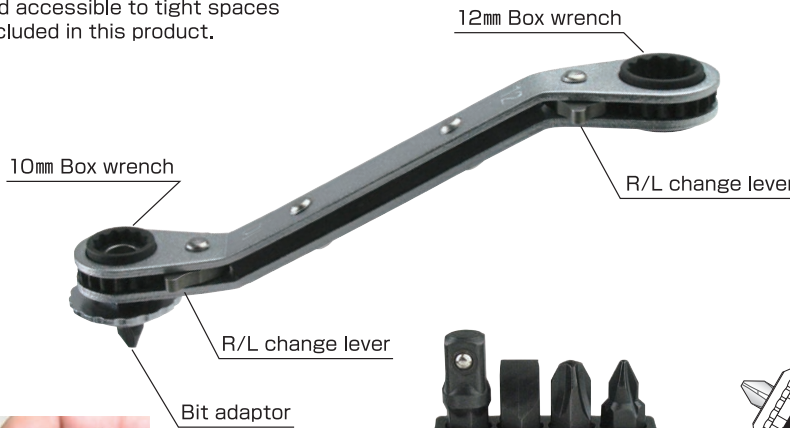

Slim Head 24.5mm

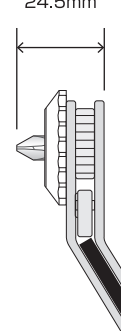

| Item No. | Bit Sizes | Length (mm) | Wgt.(g) |
|----------|----------------------------------------|-------------|---------|
| DR-56 | ⊕#1, #2, #3, ⊖6 1/4" socket adapter | 135 | 78 |

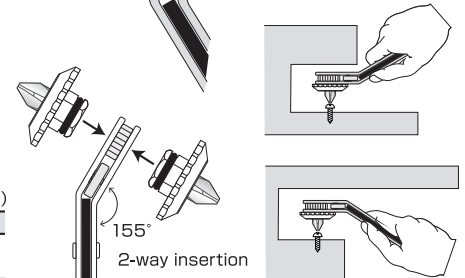

DR-10·11·15~17

RoHS BIT SET

- A comprehensive and wide selection of bits to handle any job or application.
- Bullet type bit holder suitable for portable use
- DR-16 bits are also used for rechargeable or electric drivers.

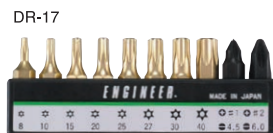
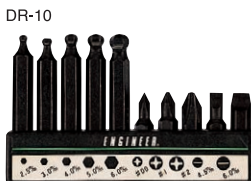

| Item No. | Number of bits | Bit Sizes | Length (mm) | Wgt.(g) |
|----------|----------------|------------------------------------------------------------------------------------------------------|-------------|---------|
| DR-10 | 10 | ⊕#00, #1, #2, ⊖4.5, 6, ●2.5, 3, 4, 5, 6 (Ball bit) | | 97 |
| DR-11 | 10 | ⊕#00, #1, #2, ⊖4.5, 6, ●1.5, 2, 2.5, 3, 4 (Hex bit) | 30 | 67 |
| DR-15 | 6 | ★/★ T5/T6, ★/☆ T7/T8, ☆/☆ T9/T10, T15/T20, T25/T27, T30/T40 | 110 | 159 |
| DR-16 | 6 | ⊕ Double end bit...#2×65 #2×110 ⊕ Step type...#0×85 #1×100 #2×150 ⊕ bit...#2/⊖6×135 | | 147 |
| DR-17 | 10 | ☆...T8, T10, T15, T20, T25, T27, T30, T40 ⊕ Double end bit...#1/⊖4.5, #2/⊖6 (⊕ bits are magnetic) | 30 | 68 |

SCREW REMOVAL

SCISSORS

NIPPERS

PLIERS

CRIMPING STRIPPING

TWEEZERS

SCREW DRIVERS

SPECIAL DRIVERS

WRENCHES

CUTTING PROCESSING

SETS CASES

SOLDERING EQUIPMENT

ESD CHEMICALS

Special Drivers



DT/DTC/DTP/DTY SERIES



MOBILE PHONE DRIVER

Made for special screws, ideal for maintenance work of cordless phones, cellular phones, etc.



Torx (Hex-lobe) screws

There may be a projection in the center of screw hole for prevention of theft and tampering. Torx (Hex-lobe) screws are used for cordless phone, transceiver, precision instruments, etc.

DTC-27



Point size

(mm)

| Item No. | Point size | Shaft Length | Shaft diam. | Handle diam. | O.A. Length | Main Use | |
|----------|------------|--------------|-------------|--------------|-------------|----------|-------------------|
| DTC-20 | 3.6 | 90 | 4.5 | 7.0 | 25 | 190 | Game console/Soft |
| DTC-27 | 4.6 | 90 | 5.9 | 7.0 | 25 | 190 | Game console |

DAP-01



DTP-05



Point size

(mm)

| Item No. | Point size | Shaft Length | Shaft diam. | Handle diam. | O.A. Length | Main Use |
|----------|------------|--------------|-------------|--------------|-------------|-------------------|
| DAP-01 | 0.9 | 23 | 3.0 | 10 | 113 | Smart phone |
| DTP-03 | 1.3 | 75 | 3.0 | 15 | 146 | Mobile phone, etc |
| DTP-05 | 1.7 | 100 | 5.5 | 25 | 200 | Mobile phone, etc |



Applicable to tampering-proof screws (T6~T20)

(mm)

| Item No. | Point size | Shaft length | Shaft diam. | Handle diam. | O.A. Length | Main Use |
|----------|------------|--------------|-------------|--------------|-------------|--------------------------|
| DT-02 | ★ 0.9 T2 | 75 | 3.0 | 15 | 146 | Game console |
| DTX-04 | ★ 1.2 TX4 | 75 | 3.0 | 15 | 146 | Smart phone/Mobile phone |
| DT-04 | ★ 1.3 T4 | 75 | 3.0 | 15 | 146 | Smart phone/Mobile phone |
| DT-05 | ★ 1.4 T5 | 75 | 3.0 | 15 | 146 | |
| DT-06 | ★ 1.7 T6 | 75 | 3.0 | 15 | 146 | |
| DTX-08 | ★ 2.0 TX8 | 75 | 3.0 | 15 | 146 | Smart phone/Mobile phone |
| DT-08 | ★ 2.3 T8 | 75 | 3.0 | 15 | 146 | |
| DT-10 | ★ 2.7 T10 | 100 | 5.5 | 25 | 200 | |
| DT-15 | ★ 3.3 T15 | 100 | 5.5 | 25 | 200 | |
| DT-20 | ★ 3.8 T20 | 100 | 5.5 | 25 | 200 | |

DAT-02



Point size

(mm)

| Item No. | Point size | Shaft Length | Shaft diam. | Handle diam. | O.A. Length | Main Use |
|----------|------------|--------------|-------------|--------------|-------------|--------------|
| DAT-02 | ★ 0.9 T2 | 23 | 3.0 | 10 | 113 | Game console |

DTY-03



Point size

(mm)

| Item No. | Point size | Shaft Length | Shaft diam. | Handle diam. | O.A. Length | Main Use |
|----------|------------|--------------|-------------|--------------|-------------|-------------------|
| DTY-02 | 1.7 | 75 | 3.0 | 15 | 146 | Game/Mobile phone |
| DTY-03 | 2.4 | 75 | 3.0 | 15 | 146 | Game/Mobile phone |

DR-18



BIT SET FOR MOBILE PHONE

10-in-1 special driver bit set

- Easy to distinguish different color band.
- Magnet point attracting a tiny screw.

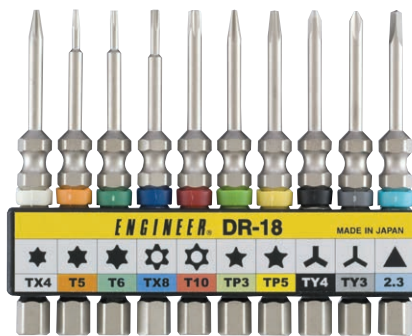

DR-50



TWIN WRENCH DRIVER (For Special Screws)

Ideal for sure-gripped work in restricted areas.

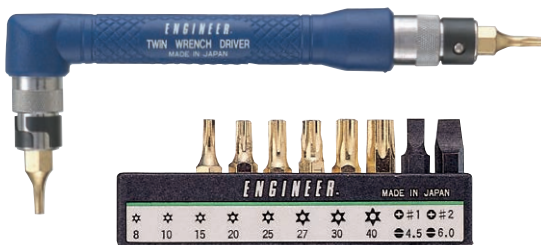

- Off-set twin wrench driver with 8 Torx bits and 2 ⊕/⊖ bits.
- Non-slip knurled cushion handle.
- Bullet type replaceable bit holder.

CONTENTS

(mm)

| Shape of Bit | Point | Size |
|--------------|-------|------------------------|
| Torx bit | ★ | 8 10 15 20 25 27 30 40 |
| ⊕/⊖ bit | ⊕/⊖ | ⊕#1/⊖4.5 ⊕#2/⊖6.0 |

Bit set is separately available [\[DR-17\]](#)

SCREW REMOVAL

SCISSORS

NIPPERS

PLIERS

CRIMPING STRIPPING

TWEEZERS

SCREW DRIVERS

SPECIAL DRIVERS

WRENCHES

CUTTING PROCESSING

SETS CASES

SOLDERING EQUIPMENT

ESD CHEMICALS

DR-51

MASTER GRIP DRIVER (For Hex-Lobe Screws)

Accommodates 12 different sized Torx (hex-lobe) screws.

- 6 double ended hex-lobe bits fit 12 different screw sizes from T-5 to T-40.
- Bits are made of chrome-vanadium steel.
- Cushion grip handle.



Easy slide-in

Cushion grip



■ Contents of bit set (12 sizes)

| Tip Shape | Tip Size | O.A.Length |
|-----------|-----------|------------|
| | T-5/T-6 | 110mm |
| | T-7/T-8 | |
| | T-9/T-10 | |
| | T-15/T-20 | |
| | T-25/T-27 | |
| | T-30/T-40 | |



Standard accessory

- Hex lobe bit set
- Bullet-type bit holder
- Master grip

Bit set is separately available **DR-15**

■ Applications for hex-lobe screws (mm)

| Size | T5 | T6 | T7 | T8 | T9 | T10 | T15 | T20 | T25 | T27 | T30 | T40 |
|---------------|-----|-----|-----|------|-----|-----|------|-----|-----|-----|-----|-----|
| Outer diam. | 1.4 | 1.7 | 2.0 | 2.3 | 2.5 | 2.7 | 3.3 | 3.8 | 4.4 | 5.0 | 5.5 | 6.6 |
| Screw adapted | - | M2 | - | M2.5 | - | M3 | M3.5 | M4 | M5 | M5 | M6 | M8 |

※Diameter is just for reference

DJ-03·04

PLUG JACK DRIVER

- Ideal for use with radio microphone jacks.



DJ-03
C type

DJ-04
C type



C type

| Item No. | Tip shape & size | | | Shaft length | Shaft diam. | Handle diam. | O.A. Length |
|----------|------------------|---|---|--------------|-------------|--------------|-------------|
| | A | B | C | | | | |
| DJ-03 | - | - | 4 | 75 | 4.3 | 16 | 150 |
| DJ-04 | - | - | 6 | 75 | 4.3 | 16 | 150 |

(mm)

DN-01~12

NUT DRIVER

- Anti-abrasive point of special steel.
- Nickel-plated finish.

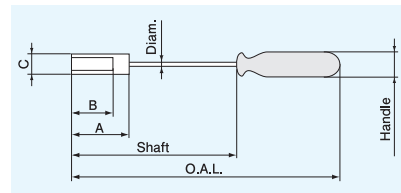
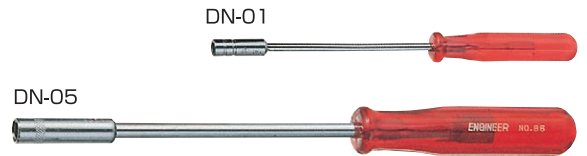

| Item No. | Size | A | B | C | Shaft Length | Shaft diam. | Handle diam. | O.A. Length | Screw adapted |
|----------|------|----|----|-----|--------------|-------------|--------------|-------------|---------------|
| DN-01 | 3 | 18 | 9 | 6 | 75 | 3.0 | 11 | 130 | (1.4) |
| DN-02 | 4 | 18 | 9 | 6 | 75 | 3.0 | 11 | 130 | 2 |
| DN-03 | 4.5 | 18 | 9 | 8 | 75 | 4.0 | 13 | 145 | (2.3) |
| DN-04 | 5 | 35 | 25 | 7.5 | 75 | 4.3 | 16 | 150 | (2.6) |
| DN-05 | 5.5 | 35 | 25 | 9 | 125 | 5.5 | 18 | 210 | 3 |
| DN-06 | 6 | 35 | 25 | 9 | 125 | 5.5 | 18 | 210 | (3) |
| DN-07 | 7 | 35 | 25 | 11 | 125 | 5.5 | 18 | 210 | 4 |
| DN-08 | 8 | 35 | 25 | 12 | 125 | 5.5 | 18 | 210 | 5 |
| DN-09 | 9 | 35 | 25 | 13 | 125 | 5.5 | 18 | 210 | (5) |
| DN-10 | 10 | 35 | 25 | 14 | 125 | 6.3 | 22 | 220 | 6 |
| DN-12 | 12 | 36 | 25 | 17 | 125 | 6.3 | 22 | 220 | (6) |

(mm)

() = old specifications

DNC-55T·57T·65T

NUT CATCHING DRIVER

Magnet hold type for easy operation

- Solid shaft machined from one piece of metal, for improved durability.
- Suitable for maintenance service of facsimile machine and photocopying machine.
- Sliding magnet in socket attracts and catches a hex bolt while fitting different heights of the heads.
- Material: Cr-V (shaft), Cellulose Acetate (handle)

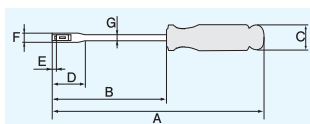
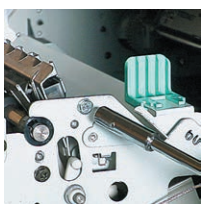
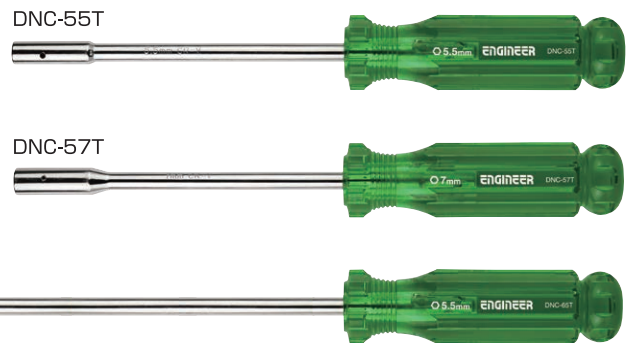

| Item No. | Size | A | B | C | D | E | F | G | Wgt. |
|----------|------|-----|-----|----|----|---------|----|---|------|
| DNC-55T | 5.5 | 233 | 127 | 29 | 32 | 0.5~3.0 | 9 | 7 | 120g |
| DNC-57T | 7 | 233 | 127 | 29 | 37 | 0.5~4.3 | 11 | 7 | 125g |
| DNC-65T | 5.5 | 336 | 230 | 29 | 32 | 0.5~3.0 | 9 | 7 | 153g |

(mm)

DK-13

REVERSIBLE PRECISION DRIVER SET

- Driver's shaft length to be adjustable 18~90mm.
- Magnetic point ⊕ for hard-to-reach screws.
- ● 4mm slim shaft with double-ended blade (5-in-1)
- Cushioned grip for well-fitting with fingers.
- With rotary cap for quick rotation or precise alignment work

| | |
|-----------------------------------|---------|
| Contents 3 pcs. (Double-ended) | |
| Length: 125mm | |
| # 00 | ⊕ 2.5mm |
| # 0 | ⊕ 3.0mm |
| # 0 | ⊕ 4.0mm |

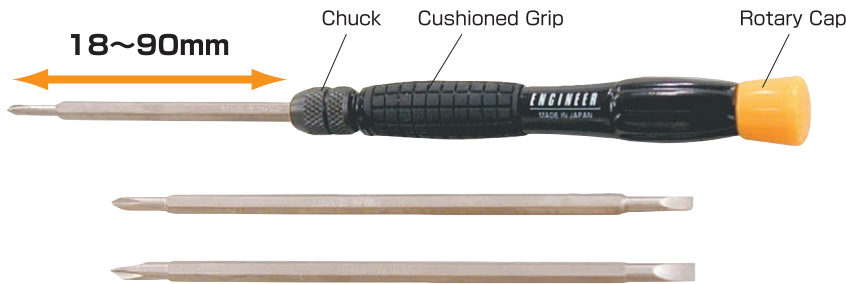

DKD-01

CIRCUIT TESTING DRIVER

- AC80~250V, DC100~300V
- For continuity & transmitting test
- O.A. Length: 129mm

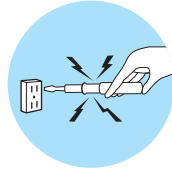

DKD-03

LED CIRCUIT TESTER

- AC100-250V (Low voltage use)
- High brightness LED built-in
- Continuity check of circuit
- Polarity check of electric outlet
- Blade (3.0 x 0.4mm) with protective cap
- O.A. Length : 120mm

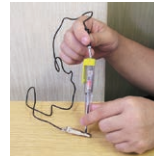

Continuity check



DB-15~40

BALL POINT DRIVER

- Ball head will work from an angle up to 30° off axis.
- Heat-treated alloy steel with electroless nickel plating
- Magnetized point



Ball Ended Point.

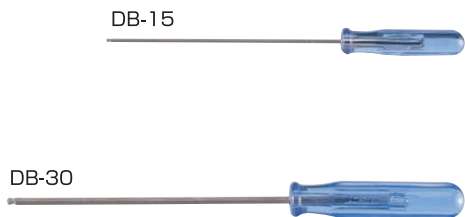

DH-15~50

HEX DRIVER

- Heat-treated, chrome-molybdenum alloy steel blade.



| (mm) | | | | | |
|----------|---------|--------------|-------------|--------------|-------------|
| Item No. | Size ●↕ | Shaft length | Shaft diam. | Handle diam. | O.A. Length |
| DB-15 | 1.5 | 70 | 1.5 | 11 | 124 |
| DB-20 | 2 | 70 | 2 | 11 | 124 |
| DB-25 | 2.5 | 70 | 2.5 | 16 | 143 |
| DB-30 | 3 | 100 | 3 | 16 | 173 |
| DB-40 | 4 | 120 | 4 | 18 | 204 |

| (mm) | | | | |
|----------|---------|--------------|--------------|-------------|
| Item No. | Size ●↕ | Shaft length | Handle diam. | O.A. Length |
| DH-15 | 1.5 | 90 | 11 | 144 |
| DH-20 | 2 | 90 | 11 | 144 |
| DH-25 | 2.5 | 90 | 11 | 144 |
| DH-30 | 3 | 90 | 16 | 163 |
| DH-40 | 4 | 90 | 16 | 163 |
| DH-50 | 5 | 90 | 18 | 175 |

SCREW REMOVAL

SCISSORS

NIPPERS

PLIERS

CRIMPING STRIPPING

TWEEZERS

SCREW DRIVERS

SPECIAL DRIVERS

WRENCHES

CUTTING PROCESSING

SETS CASES

SOLDERING EQUIPMENT

ESD CHEMICALS

DK-14

RoHS NUT DRIVER SET

- Set of 6 nut drivers with across flats 3~6mm
- Magnetized sockets



Slim socket design

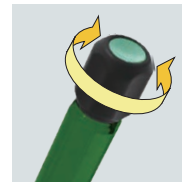

With rotary cap



Self-standing holder

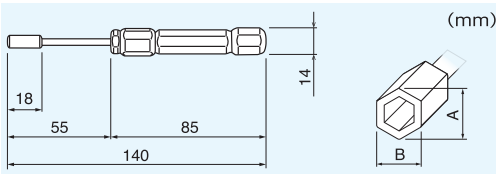

| Materials | |
|--------------------------|--|
| Socket:Cr-Mo | |
| Shaft:Cr-V | |
| Handle:Cellulose Acetate | |
| Cap:PP | |

| Item No. | Across Flats | Screw Diameter | Ext. Socket Size | | Wgt. |
|----------|--------------|----------------|------------------|-----|---------------------------|
| | | | A | B | |
| DK-14 | 3 | M1.4/M1.5 | 6.3 | 5.6 | 155g (Holder included) |
| | 4 | M2 | 6.3 | 5.6 | |
| | 4.5 | M2.3 | 8 | 7 | |
| | 5 | M2.5/M2.6 | 8 | 7 | |
| | 5.5 | M3 | 9.1 | 8 | |
| | 6 | M3.5 | 9.1 | 8 | |

DK-01・02

RoHS HEX DRIVER SET

- Set of 4 (DK-01) and 6 (DK-02) most popular hex drivers in a vinyl pouch.



- DK-01 (4pcs)**
- DH-15
 - DH-20
 - DH-25
 - DH-30



- DK-02 (6pcs)**
- DH-15
 - DH-20
 - DH-25
 - DH-30
 - DH-40
 - DH-50

| Screw adapted (mm) | | |
|--------------------|-----------|-----------|
| Size | Cap screw | Set screw |
| | | |
| 1.5 | M1.6,M2 | M3 |
| 2.0 | M2.5,M2.6 | M4 |
| 2.5 | M3 | M5 |
| 3.0 | M4 | M6 |
| 4.0 | M5 | M8 |
| 5.0 | M6 | M10 |

DK-03 BALL DRIVER SET

- Set of 5 most popular ball drivers in a vinyl pouch.



- DK-03(5pcs)**
- DB-15
 - DB-20
 - DB-25
 - DB-30
 - DB-40



DK-04

RoHS NUT DRIVER SET

7-in-1 assortment of Compact-sized Nut Drivers
 Contents:ø3, 3.5, 4, 4.5, 5, 5.5, 6mm

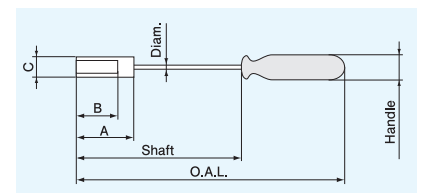

| (mm) | | | | | | | | | |
|------|----|---|---|--------------|-------------|--------------|-------------|----|-----|
| Size | A | B | C | Shaft length | Shaft diam. | Handle diam. | O.A. Length | | |
| 3 | 18 | 9 | 6 | 75 | 3.0 | 11 | 130 | | |
| 3.5 | | | 6 | | | | | | |
| 4 | | | 6 | | | | | | |
| 4.5 | | | 8 | | 4.0 | | | 13 | 145 |
| 5 | | | 8 | | | | | | |
| 5.5 | | | 9 | | | | | | |
| 6 | 9 | | | | | | | | |

DM-20  **PRECISION DRIVER SET**

DM-30  **PRECISION DRIVER SET**

DM-60  **PRECISION DRIVER SET**



| Item No. | Tip Size | Blade Diam. | O.A. Length |
|----------|----------|-------------|-------------|
| DM-21 | #0000 | 1.4 | 76 |
| DM-22 | #000 | 1.6 | 84 |
| DM-23 | #00 | 2 | 90 |
| DM-24 | #0 | 2.4 | 102 |
| DM-25 | #1 | 3 | 110 |
| DM-26 | #1 | 3 | 118 |

| Item No. | Tip Size | Blade Diam. | O.A. Length |
|----------|----------|-------------|-------------|
| DM-31 | 1.0×0.2 | 1 | 73 |
| DM-32 | 1.2×0.3 | 1.2 | 79 |
| DM-33 | 1.8×0.3 | 1.8 | 89 |
| DM-34 | 2.4×0.45 | 2.4 | 102 |
| DM-35 | 3.0×0.6 | 3 | 110 |
| DM-36 | 3.5×0.7 | 3.5 | 118 |

| Item No. | Tip Size | Blade Diam. | O.A. Length |
|----------|----------|-------------|-------------|
| DM-22 | #000 | 1.6 | 84 |
| DM-24 | #0 | 2.4 | 102 |
| DM-25 | #1 | 3 | 110 |
| DM-33 | 1.8×0.3 | 1.8 | 89 |
| DM-34 | 2.4×0.45 | 2.4 | 102 |
| DM-35 | 3.0×0.6 | 3 | 110 |

DK-05  **INTERCHANGEABLE DRIVER SET**

With circuit testing driver handle for low voltage.
(AC80~250V/DC100~300V)
Contents: ⊖5.5mm, ⊕#00, #0, #1, #2, #3

DK-06  **INTERCHANGEABLE DRIVER SET**

With circuit testing driver handle for low voltage.
(AC80~250V/DC100~300V)
Contents: ⊕#1, #2, ⊖3, 5.5mm, ⊙5.5mm, awl

DK-08  **INTERCHANGEABLE DRIVER SET**

Contents: ⊙4, 5.5, 6, 7, 8, 10mm

DK-05P-06P  **INTERCHANGEABLE DRIVER SET**

- Cost-saving package in Plastic blow-mould case
- Contents exactly same as DK-05 & DK-06

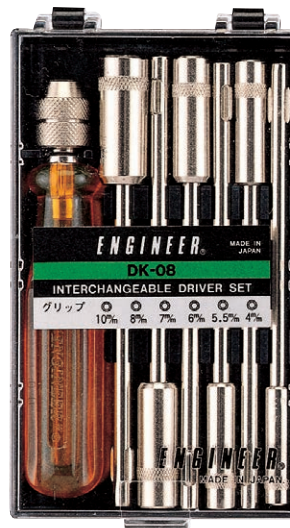
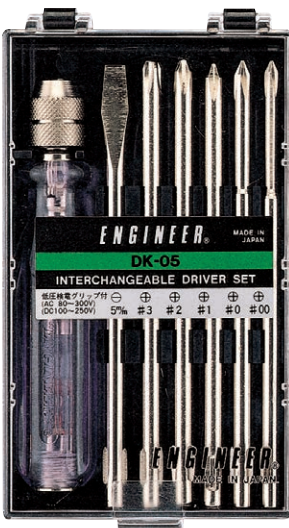

SCREW REMOVAL

SCISSORS

NIPPERS

PLIERS

CRIMPING STRIPPING

TWEEZERS

SCREW DRIVERS

SPECIAL DRIVERS

WRENCHES

CUTTING PROCESSING

SETS CASES

SOLDERING EQUIPMENT

ESD CHEMICALS

DA-48~52

CERAMIC ALIGNMENT SCREWDRIVER

Four-in-One Slotted Tip & Hex Core Ceramic Alignment Screwdrivers.

- Perfect non-conductive tip for high frequency trimming.
- Ideal alignment screwdriver for short-circuit prevention
- Four-in-one double ended tool.
- Pen-type design with protective caps and pocket clip.
- $\phi 8 \times 136$ mm long

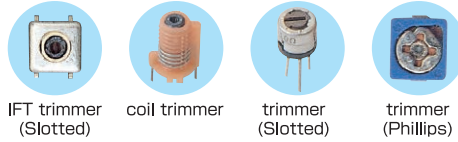

| Item No. | Size | Core |
|----------|---------------------------|------|
| DA-48 | $\ominus 0.7 \times 1.3$ | 2 |
| | $\ominus 0.4 \times 2.4$ | 2.5 |
| DA-50 | $\ominus 0.35 \times 0.8$ | 2 |
| | $\oplus \#0$ | - |
| DA-51 | $\ominus 0.4 \times 0.9$ | 2 |
| | $\ominus 0.4 \times 1.8$ | 2.5 |
| DA-52 | $\ominus 0.4 \times 1.3$ | 2 |
| | $\ominus 0.7 \times 2.5$ | 2.5 |



Tips are made of fine, durable zirconia ceramic.



DK-90

CERAMIC ALIGNMENT SCREWDRIVER SET

Assortment of DA-48~52 (4pcs.)



DA-53~59

CERAMIC ALIGNMENT SCREWDRIVER

Pen type Ceramic Alignment Driver for service and assembly line work

- Two-in-one, slotted tip and hex, core (except DA-58)
- With pen-type cap for protection and portable use
- $\phi 9 \times 135$ mm long

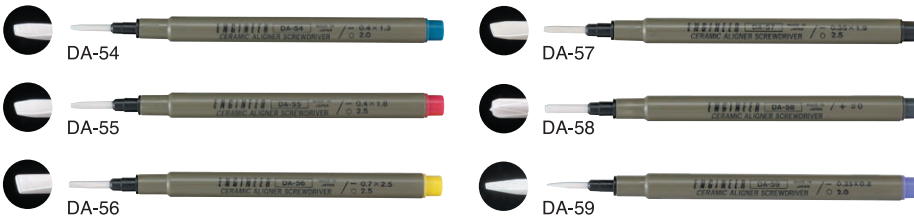

| Item No. | Size | Core | Bottom color |
|----------|----------------------------|------|--------------|
| DA-53 | $\ominus 0.4 \times 0.9$ | 2.0 | Green |
| DA-54 | $\ominus 0.4 \times 1.3$ | 2.0 | Blue |
| DA-55 | $\ominus 0.4 \times 1.8$ | 2.5 | Red |
| DA-56 | $\ominus 0.7 \times 2.5$ | 2.5 | Yellow |
| DA-57 | $\ominus 0.35 \times 1.95$ | 2.5 | Black |
| DA-58 | $\oplus \#0$ | - | Gray |
| DA-59 | $\ominus 0.35 \times 0.8$ | 2.0 | Purple |

DA-72~79

CERAMIC ALIGNMENT SCREWDRIVER

The DA-70 series ceramic alignment screwdrivers are designed with a long slender shaft for a wider application of alignment in remote areas.

- Fine zirconia ceramic tipped alignment screwdrivers, highly intensive, durable, and perfectly non-conductive
- Slide-in shaft is attachable to other tools & equipment
- Long, slim design for easy access to remote areas
- Two-in-one, slotted tip and hex, core (except DA-78)

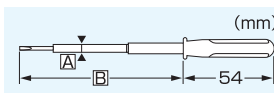

| Item No. | Size | Core | A Size | B Size | Bottom color |
|----------|----------------------------|------|------------|--------|--------------|
| DA-72 | $\ominus 0.4 \times 2.4$ | 2.5 | $\phi 4$ | 94 | Orange |
| DA-73 | $\ominus 0.4 \times 0.9$ | 2.0 | $\phi 3.5$ | 95 | Green |
| DA-74 | $\ominus 0.4 \times 1.3$ | 2.0 | | | Blue |
| DA-75 | $\ominus 0.4 \times 1.8$ | 2.5 | | | Red |
| DA-76 | $\ominus 0.7 \times 2.5$ | 2.5 | $\phi 4$ | 94 | Yellow |
| DA-77 | $\ominus 0.35 \times 1.95$ | 2.5 | | | Black |
| DA-78 | $\oplus \#0$ | - | | 92 | Gray |
| DA-79 | $\ominus 0.35 \times 0.8$ | 2.0 | $\phi 3.5$ | 95 | Purple |

DA-81~88

CERAMIC ALIGNMENT SCREWDRIVER

Compact designed ceramic alignment drivers. Perfect for assembly line trimming.

- Fine zirconia ceramic tipped alignment screwdrivers, highly intensive, durable, and perfectly non-conductive.
- Two-in-one function with slotted tip and hex core. (except DA-88)
- Ergonomically designed with convenient rotary cap.

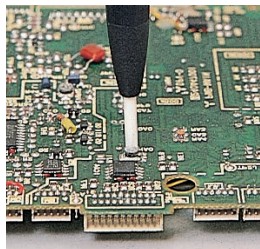
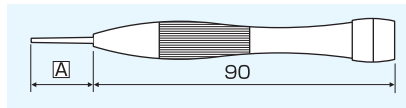
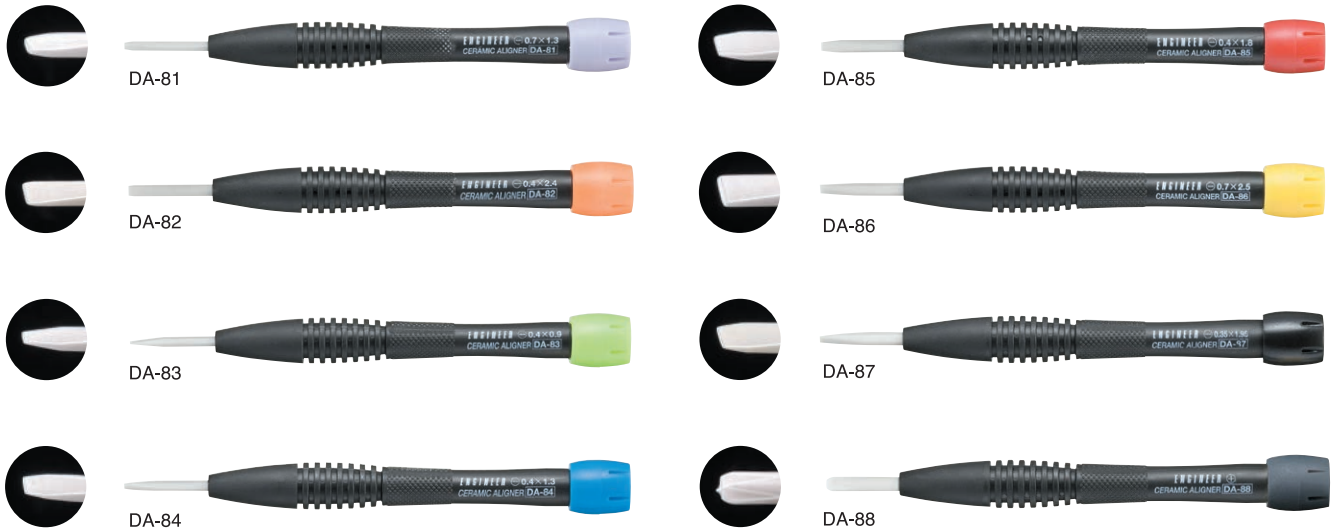
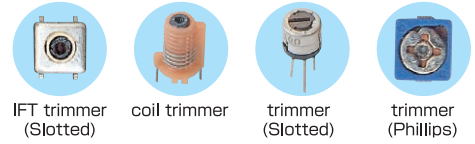

| Item No. | Size | ●Core | ASize | BOTTOM COLOR |
|----------|------------|-------|-------|--------------|
| DA-81 | ⊖0.7×1.3 | 2 | 18 | Purple |
| DA-82 | ⊖0.4×2.4 | 2.5 | | Orange |
| DA-83 | ⊖0.4×0.9 | 2 | | Green |
| DA-84 | ⊖0.4×1.3 | 2 | | Blue |
| DA-85 | ⊖0.4×1.8 | 2.5 | | Red |
| DA-86 | ⊖0.7×2.5 | 2.5 | | Yellow |
| DA-87 | ⊖0.35×1.95 | 2.5 | | Black |
| DA-88 | ⊕#0 | — | | 15 |

DK-91

CERAMIC ALIGNMENT SCREWDRIVER SET

◇ Assortment of DA-81~88 (8pcs.)



DA-01·02

ALIGNMENT SCREWDRIVER

- Alignment tool for TV, tuner, trimmer under a high frequency current.

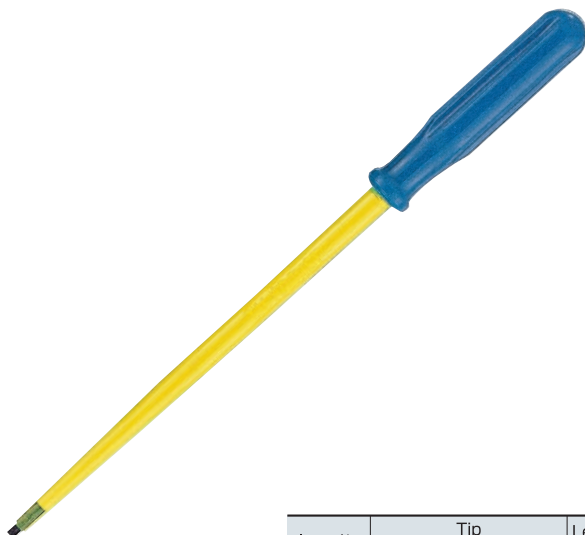

| Item No. | Tip | | | Length of Rod | Handle |
|----------|----------|-------|-------|---------------|--------|
| | Material | Thick | Width | | |
| DA-01 | SK steel | 0.5 | 2.0 | 100 | φ12×54 |
| DA-02 | | | | 150 | |

DA-40

ALIGNMENT SCREWDRIVER

- E.S.D. free construction (Safe from static discharge)
- Overall length: 125mm
- Tip: ⊖2×0.5 & ⊖2×0.5mm



SCREW REMOVAL

SCISSORS

NIPPERS

PLIERS

CRIMPING STRIPPING

TWEEZERS

SCREW DRIVERS

SPECIAL DRIVERS

WRENCHES

CUTTING PROCESSING

SETS CASES

SOLDERING EQUIPMENT

ESD CHEMICALS

Wrenches



SMART MONKEY WRENCH

Features

- Only 2mm-thick jaws fit in a narrow area.
- Ideal for fastening coaxial (BNC) connectors, double nut, etc.
- No damage given to housing of BNC connectors
- Accurately machined finish of thin edge
- Made of Chrome Vanadium steel
- Extra long jaws and wide opening type (TWM-07 & TWM-08)

TWM-03·07·08

SMART MONKEY WRENCH

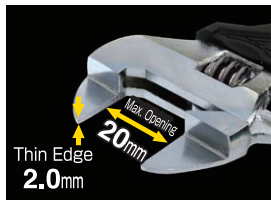

150mm size with soft handle

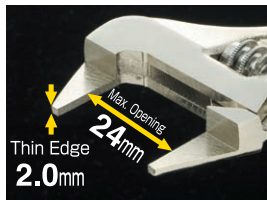

150mm size

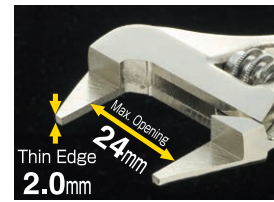

100mm size Stubby with cushioned handle (TPR)



TWM-03



TWM-07



TWM-08

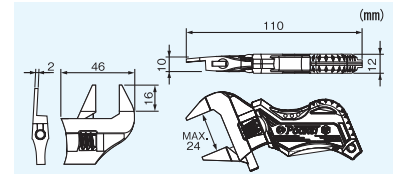
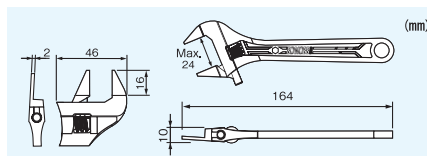
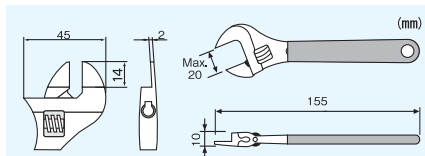

VARIOUS APPLICATIONS



TWM-01·02·04·05

ADJUSTABLE ANGLE WRENCH

- Heavy duty adjustable wrench
- Soft grip for easy handling.



TWM-04



TWM-02



TWM-01



TWM-05

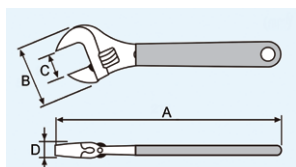

| Item No. | Nominal Size | A | B | C | D |
|----------|--------------|-----|----|----|----|
| TWM-04 | 100 | 100 | 32 | 13 | 8 |
| TWM-01 | 150 | 155 | 45 | 20 | 10 |
| TWM-02 | 200 | 210 | 57 | 25 | 14 |
| TWM-05 | 250 | 260 | 68 | 30 | 15 |

SCREW REMOVAL

SCISSORS

NIPPERS

PLIERS

CRIMPING STRIPPING

TWEEZERS

SCREW DRIVERS

SPECIAL DRIVERS

WRENCHES

CUTTING PROCESSING

SETS CASES

SOLDERING EQUIPMENT

ESD CHEMICALS

TS-04

MINI COMBINATION SPANNER SET

- 8-in-1 Combination spanner set with key chain
- Box-end inclined (30°)
- Thickness: 1.5mm
- Material: Stainless steel



◆ This item is individually available. (mm)

| Item No. | Sizes | | Thick | Length |
|----------|-------|------|-------|--------|
| | Box | Open | | |
| TS-41 | 4.0 | 3.5 | 1.5 | 100 |
| TS-42 | 4.5 | 4.0 | | 106 |
| TS-43 | 5.0 | 4.5 | | |
| TS-44 | 5.5 | 5.0 | | |
| TS-45 | 6.0 | 5.5 | 1.5 | 114 |
| TS-46 | 6.5 | 6.0 | | |
| TS-47 | 7.0 | 6.5 | | |
| TS-48 | 8.0 | 7.0 | | |

DROP-FORGED WRENCH SET

- Features
- 5-in-1 Set with carrying case
 - Material: Cr-V Steel

TS-05

OPEN-END WRENCH SET

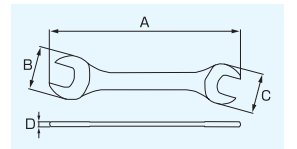

(mm)

| Size | A | B | C | D | Wgt.(g) |
|---------|-----|----|----|-----|---------|
| 3,2×5,5 | 70 | 13 | 10 | 2,4 | 7 |
| 4×5 | 70 | 13 | 10 | 2,4 | 7 |
| 6×7 | 80 | 16 | 14 | 2,7 | 12 |
| 8×9 | 90 | 20 | 18 | 3 | 17 |
| 10×11 | 100 | 23 | 21 | 3 | 23 |

TS-06

COMBINATION WRENCH SET

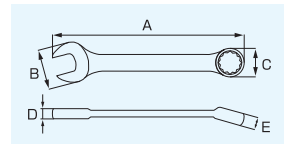

(mm)

| Size | A | B | C | D | E | Wgt.(g) |
|------|----|------|-----|-----|-----|---------|
| 3.2 | 77 | 10 | 6.5 | 3 | 3.1 | 7 |
| 3.5 | 77 | 10 | 6.5 | 3 | 3.1 | 7 |
| 4 | 77 | 10 | 7.5 | 3 | 3.1 | 7 |
| 5 | 82 | 11.8 | 9 | 3.2 | 4.1 | 9 |
| 5.5 | 82 | 11.8 | 9.5 | 3.2 | 4.1 | 9 |

TS-07

COMBINATION WRENCH SET

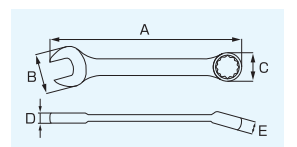

(mm)

| Size | A | B | C | D | E | Wgt.(g) |
|------|-----|------|------|-----|-----|---------|
| 6 | 88 | 15 | 10.4 | 3.8 | 5 | 14 |
| 7 | 88 | 15 | 11.5 | 3.8 | 5 | 14 |
| 8 | 94 | 17.2 | 12.5 | 4.3 | 6 | 20 |
| 9 | 98 | 19.4 | 14 | 4.6 | 6.2 | 23 |
| 10 | 103 | 21.5 | 15.3 | 5.1 | 6.6 | 29 |

TWB-01·02·04·05

IRoHS BALL POINT HEX WRENCH SET

Ball head (magnetized) works from an angle up to 30° off axis.

- Heat treated special alloy with electroless nickel plating
- Hardness : HRC57±2



TWB-01 8-in-1 Standard Long Shank



TWB-02 8-in-1 Stubby Arm, Long Shank

- Stubby arm accessible to restricted area where overhead space is tight

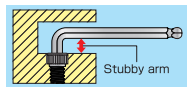

| | TWB-01 (8 pcs./set) | TWB-02 (8 pcs./set) | TWB-04 (8 pcs./set) | TWB-05 (8 pcs./set) |
|-------------------------|----------------------------------|------------------------|------------------------|------------------------|
| Across Flat ● I (mm) | A x B (mm) (Individual model) | A x B (mm) | A x B (mm) | A x B (mm) |
| ● 1.5 | 81 x 14 (TWB-15) | 81 x 4 | 51 x 14 | 51 x 4 |
| ● 2.0 | 96 x 16 (TWB-20) | 96 x 5 | 58 x 16 | 58 x 5 |
| ● 2.5 | 111 x 18 (TWB-25) | 111 x 6 | 65 x 18 | 65 x 6 |
| ● 3.0 | 127 x 20 (TWB-30) | 127 x 8 | 74 x 20 | 74 x 8 |
| ● 4.0 | 142 x 25 (TWB-40) | 142 x 9 | 78 x 25 | 78 x 9 |
| ● 5.0 | 160 x 28 (TWB-50) | 160 x 11 | 89 x 28 | 89 x 11 |
| ● 6.0 | 180 x 32 (TWB-60) | 180 x 13 | 101 x 32 | 101 x 13 |
| ● 8.0 | 198 x 36 (TWB-80) | 198 x 16 | 112 x 36 | 112 x 16 |

TWB-04 8-in-1 Standard Arm, Short Shank

- Hand-held compact sized body in bullet holder

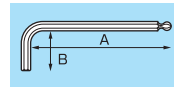

TWB-05 8-in-1 Stubby, Short Shank

- Stubby arm accessible to restricted area where overhead space is tight
- Hand-held compact sized body in bullet holder

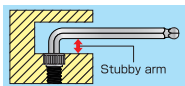

TWB-13~80 IRoHS BALL POINT HEX WRENCH

- Electroless nickel plated

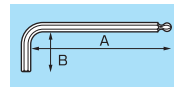

| Item No. | Across Flats ● mm | A x B mm |
|----------|----------------------|----------|
| TWB-13 | 1.27 | 70 x 13 |
| TWB-15 | 1.5 | 81 x 14 |
| TWB-20 | 2.0 | 96 x 16 |
| TWB-25 | 2.5 | 111 x 18 |
| TWB-30 | 3.0 | 127 x 20 |
| TWB-40 | 4.0 | 142 x 25 |
| TWB-50 | 5.0 | 160 x 28 |
| TWB-60 | 6.0 | 180 x 32 |
| TWB-80 | 8.0 | 198 x 36 |

TWH-01·02·04 IRoHS HEX KEY WRENCH SET

METRIC SIZE

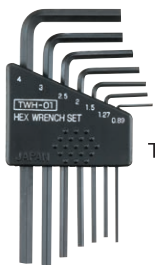

TWH-01

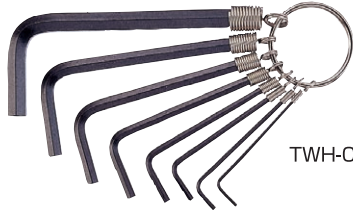

TWH-04

| Item No. | pcs. | Set(mm) |
|----------|------|----------------------------------------|
| TWH-01 | 7 | 0.89, 1.27, 1.5, 2.0, 2.5, 3.0, 4.0 |
| TWH-04 | 8 | 1.5, 2.0, 2.5, 3.0, 4.0, 5.0, 6.0, 8.0 |

INCH SIZE



TWH-02

| Item No. | pcs. | Set(inch) |
|----------|------|---------------------------------------------------|
| TWH-02 | 7 | 0.71mm, 0.89mm, 0.05", 1/16", 5/64", 3/32", 7/64" |

TWH-11~25 IRoHS HEX KEY WRENCH

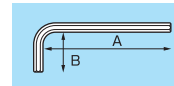

Hex Key Wrench in metric size

| Item No. | Across Flats ● mm | L Size |
|----------|----------------------|----------|
| TWH-11 | 1.5 | 45 x 14 |
| TWH-12 | 2.0 | 50 x 16 |
| TWH-13 | 2.5 | 56 x 18 |
| TWH-14 | 3.0 | 63 x 20 |
| TWH-15 | 4.0 | 70 x 25 |
| TWH-16 | 5.0 | 80 x 28 |
| TWH-17 | 6.0 | 90 x 32 |
| TWH-18 | 8.0 | 100 x 36 |

Applicable Sizes Chart

| Hex Across Flats I mm | Cap Screw Diam. | Set Screw Diam. |
|--------------------------|-----------------|-----------------|
| 1.27 | M1.4 | M2.5 |
| 1.5 | M1.6, M2 | M3 |
| 2.0 | M2.5, M2.6 | M4 |
| 2.5 | M3 | M5 |
| 3.0 | M4 | M6 |
| 4.0 | M5 | M8 |
| 5.0 | M6 | M10 |
| 6.0 | M8 | M12, M14 |
| 8.0 | M10 | M16, M18 |

Hex Key Wrench in inch size (mm)

| Item No. | Across Flats | L Size |
|----------|--------------|-------------|
| TWH-20 | (0.71) | 35 x 10 |
| TWH-21 | (0.89) | 38 x 10 |
| TWH-22 | 0.05"(1.27) | 40 x 11.5 |
| TWH-23 | 1/16"(1.59) | 42.5 x 12.5 |
| TWH-24 | 5/64"(1.98) | 45.5 x 13.5 |
| TWH-25 | 3/32"(2.38) | 48.5 x 14.5 |

SCREW REMOVAL

SCISSORS

NIPPERS

PLIERS

CRIMPING STRIPPING

TWEEZERS

SCREW DRIVERS

SPECIAL DRIVERS

WRENCHES

CUTTING PROCESSING

SETS CASES

SOLDERING EQUIPMENT

ESD CHEMICALS

TWS-01~05

SOCKET WRENCH SET

- Socket wrench sets contain the complete combination of most needed sockets.
- Chrome molybdenum steel sockets and chrome vanadium ratchet handles.

TWS-05



TWS-05 Contents : 52pcs. per set

| Contents | Size/Length(mm) |
|---------------------------------|-----------------------------------------------------------------------------|
| Sockets \varnothing 6.3(1/4") | 4, 4.5, 5, 5.5, 6, 7, 8, 9, 10, 11, 13 |
| | \varnothing 12.7(1/2") 10, 11, 12, 13, 14, 15, 17, 19, 22, 24, 27, 30, 32 |
| Socket for 21mm plug | 21 Across flats |
| Hex. Wrenches | 1.5, 2, 2.5 |
| Hex. Bits | 3, 4, 5, 6, 7, 8 |
| Phillips Bits | #1, #2, #3 |
| Slotted Bits | 4, 5.5, 7 |
| Plastic Spinner Handle | 200 |
| Ratchet Handles | 125, 300 |
| Extension Shafts | 100, 125, 250 |
| T Type Sliding Handles | 115, 300 |
| Universal Joints | 35, 70 |
| Bit Adapters | 25, 30 |
| Steel Case | 450×200×55 |

TWS-01·TWS-02



TWS-01 · 02 Contents : 16pcs. per set

| Contents | Size/Length(mm) |
|---------------------------------|-------------------------------------------------------------------------|
| Sockets \varnothing 6.3(1/4") | TWS-01 5/32, 3/16, 7/32, 1/4, 9/32, 5/16 |
| | TWS-02 11/32, 3/8, 13/32, 7/16, 1/2 (inch) 9, 10, 11, 13 (mm) |
| Ratchet Handles | 125 |
| Extension Shafts | 50, 150 |
| Universal Handle | 125 |
| Cross Bar | 115 |
| Steel Case | 180×120×30 |

TWS-03



TWS-03 Contents : 20pcs. per set

| Contents | Size/Length (mm) |
|---------------------------------|---------------------------------------------------|
| Sockets \varnothing 6.3(1/4") | 4, 4.5, 5, 5.5, 6, 7, 8 |
| | \varnothing 9.5(3/8") 9, 10, 12, 13, 14, 17, 19 |
| Adaptor 3/8" → 1/4" | 25 |
| Plastic Spinner Handle | 150 |
| Ratchet Handle | 200 |
| Extension Shaft | 75, 150 |
| Socket for 21mm Plug | 21 Across flats |
| Steel Case | 292×145×35 |

TWS-04



TWS-04 Contents : 34pcs. per set

| Contents | Size/Length(mm) |
|---------------------------------|----------------------------------------|
| Sockets \varnothing 6.3(1/4") | 4, 4.5, 5, 5.5, 6, 7, 8, 9, 10, 11, 13 |
| Hex. Bits | 3, 4, 5, 6, 8, 10 |
| Phillips Bits | #1, #2, #3, #4 |
| Slotted Bits | 4, 5.5, 7 |
| Hex Wrenches | 1.5, 2, 2.5 |
| Plastic Spinner Handle | 150 |
| Ratchet Handle | 125 |
| Extension Shaft | 50, 100 |
| T Type Sliding Handle | 115 |
| Universal Joint | 35 |
| Steel Case | 200×110×30 |

- with quick drive ring



Cutting and Processing

TR-01~04

TAPER REAMER

- For reaming holes in sheet metal, aluminum and similar material
- Material : Carbon steel



| (mm) | | | |
|----------|---------|-------|--------|
| Item No. | Size | Blade | Length |
| TR-01 | φ3.0~12 | 81 | 113 |
| TR-02 | φ4.0~16 | 85 | 118 |
| TR-03 | φ5.0~20 | 95 | 130 |
| TR-04 | φ6.0~30 | 107 | 145 |

※Hardness: HRC 55±3

TDS-01·02·03

TWIST DRILL SET



TDS-01



TDS-02



TDS-03

| | | (mm) | | | | | | | | | | | |
|----------|----------|------|-----|-----|-----|-----|-----|-----|-----|-----|-----|-----|-----|
| Item No. | Contents | 0.3 | 0.4 | 0.5 | 0.6 | 0.7 | 0.8 | 0.9 | 1.0 | 1.2 | 1.5 | 2.0 | 2.5 |
| TDS-01 | 5 | | | ● | ● | | | | ● | ● | | | |
| TDS-02 | 6 | | | | | | ● | | ● | ● | ● | ● | ● |
| TDS-03 | 8 | ● | ● | ● | ● | ● | ● | ● | ● | | | | |

TD-03~60

TWIST DRILL



| (mm) | | (mm) | |
|----------|------|----------|------|
| Item No. | Size | Item No. | Size |
| TD-03 | 0.3 | TD-16 | 1.6 |
| TD-04 | 0.4 | TD-18 | 1.8 |
| TD-05 | 0.5 | TD-20 | 2.0 |
| TD-06 | 0.6 | TD-25 | 2.5 |
| TD-07 | 0.7 | TD-30 | 3.0 |
| TD-08 | 0.8 | TD-32 | 3.2 |
| TD-09 | 0.9 | TD-35 | 3.5 |
| TD-10 | 1.0 | TD-40 | 4.0 |
| TD-12 | 1.2 | TD-50 | 5.0 |
| TD-15 | 1.5 | TD-60 | 6.0 |

TT-01·02

TAP HANDLE

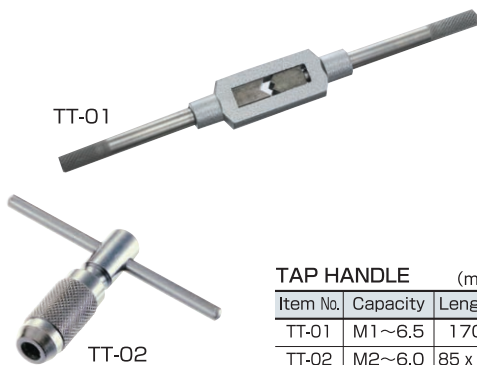

| TAP HANDLE (mm) | | |
|-----------------|----------|---------|
| Item No. | Capacity | Length |
| TT-01 | M1~6.5 | 170 |
| TT-02 | M2~6.0 | 85 x 60 |

TT-03·10~16

TAP/TAP SET



- Primary, Second & Finishing Taps (3pcs./set)



- ◀ TT-03 CONTENTS
- Tap, 4pcs(2, 3, 4, 5mm)
 - Tap Handle(TT-02)

| TAP (mm) | | |
|----------|------|-------|
| Item No. | Size | Pitch |
| TT-10 | 1.4 | 0.3 |
| TT-11 | 1.7 | 0.35 |
| TT-12 | 2.0 | 0.4 |
| TT-13 | 3.0 | 0.5 |
| TT-14 | 4.0 | 0.7 |
| TT-15 | 5.0 | 0.8 |
| TT-16 | 6.0 | 1.0 |

TP-20·23·24

MINI DRILL CHUCK/PIN VISE

- Used for various applications to drilling, tapping, piercing (handy reamer) grinding, etc.
- Featuring precision clamping chuck (collet)
- Material:Body-Brass Collet-Steel with plating

Fitting to electric driver with 2 pcs. of Single head collets

TP-20



Double ended shank (Through-hole body) with 2 pcs. of Double-head collets

TP-23



Single end with swivel head with 2 pcs. of Double-head collets

TP-24



Remove the swivel head to put a collet inside.



| (mm) | | | | | | | |
|----------|-------------|-----------------------|---------|-------|-------|-------------|------------|
| Item No. | Collet Type | Diameter of Drill Bit | | Shank | Joint | O.A. Length | Weight (g) |
| TP-23 | Double Head | ⊕0.1~1.2 | 2.0~2.5 | φ8 | - | 105 | 35 |
| | | ⊕1.2~2.0 | 2.5~3.2 | | | | |
| TP-24 | Double Head | ⊕0.1~1.2 | 2.0~2.5 | φ8 | - | 95 | 40 |
| | | ⊕1.2~2.0 | 2.5~3.2 | | | | |
| TP-20 | Single Head | ⊕0.7~1.9 | | - | ●6.3 | 50 | 20 |
| | | ⊕1.9~3.0 | | | | | |

TV-01~27



TV-04



TV-14

- With special clasp ideal for thin plate, round bar and square lumber.
- The reverse of the clasp to be used as a flat clasp.

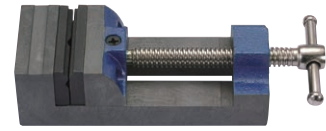

TV-26

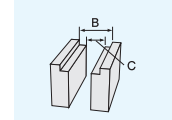

YANKEE VISE (mm)

| Item No. | Size | Max. Opening | |
|----------|------|--------------|----|
| | | B | C |
| TV-25 | 50 | 61 | 55 |
| TV-26 | 65 | 76 | 70 |
| TV-27 | 75 | 84 | 78 |

BENCH VISE (mm)

| Item No. | Size | Max. Opening | Clamp |
|----------|------|--------------|-------|
| TV-01 | 38 | 35 | 0~21 |
| TV-02 | 50 | 35 | 0~32 |
| TV-03 | 63 | 50 | 5~33 |
| TV-04 | 75 | 50 | 18~40 |

ANVIL VISE (mm)

| Item No. | Size | Max. Opening | Clamp |
|----------|------|--------------|-------|
| TV-11 | 38 | 35 | 0~25 |
| TV-12 | 50 | 35 | 0~34 |
| TV-13 | 63 | 45 | 20~45 |
| TV-14 | 75 | 55 | 20~45 |

TN-01~05



- Light weight, durable and well-balanced frame design.
- Plastic handles are shaped for perfect grip without slip.
- Saw frame is designed to be adjustable in length and capable of using even broken pieces of saw blades. (TN-04/05)



TN-01



TN-02



TN-05

※Frame length adjustable(TN-04/05)

- Blade contained TN-17 (standard) TN-13&15 (spare)
- The ideal saw blades made of SKS special steel alloy with the technological know-how.
- Entirely heat treated, best quality saw blades available.

| Item No. | Frame's Depth(mm) | Weight(g) |
|----------|-------------------|-----------|
| TN-01 | 125×75 | 170 |
| TN-02 | 120×125 | 190 |
| TN-03 | 110×280 | 240 |
| *TN-04 | ~150×75 | 200 |
| *TN-05 | ~150×125 | 220 |

TN-11~18 iRoHS SAW BLADES



TN-17

| Item No. | Nominal Size | Blade Thick (mm) | Notches/25mm | Applications |
|----------|--------------|------------------|--------------|---------------------------|
| TN-11 | #3/0 | 0.24 | 61 | Noble metals |
| TN-12 | #2/0 | 0.26 | 56 | Noble metals |
| TN-13 | #0 | 0.28 | 53.5 | Brass & thin Iron Sheet |
| TN-14 | #1 | 0.30 | 51 | Iron Sheet |
| TN-15 | #2 | 0.34 | 43 | Copper, Shell |
| TN-16 | #3 | 0.36 | 40.5 | Shell |
| TN-17 | #4 | 0.38 | 38 | Iron Sheet, Wood, Plastic |
| TN-18 | #5 | 0.40 | 35.5 | Plastic |

TM-04·05



TM-04



| Item No. | Scale |
|----------|-------|
| TM-04 | 15cm |
| TM-05 | 30cm |

TZ-02~04



TZ-02 Adjustable blade



TZ-03



| Item No. | Blade Size | Shape | Length |
|----------|----------------|--------------|--------|
| TZ-02 | 250mm24notches | Plastic Grip | 260mm |
| TZ-03 | | Piping Frame | 400mm |

Die casting Aluminum handle

- Replacement blade [TZ-04] (12pcs/dozen)

TZ-05·07



SCRIBER
TZ-05
●210mm

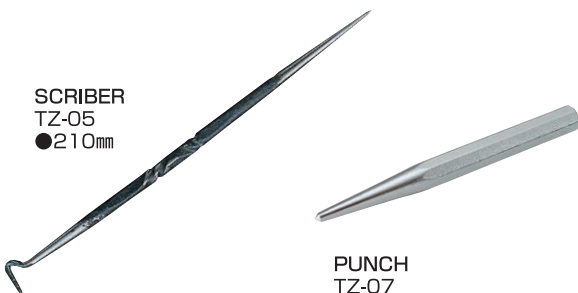

PUNCH
TZ-07
●100mm

TF-06·07·10



TF-07



TF-10



| Item No. | Shape | Length(mm) | Grip |
|----------|-------|------------|--------|
| TF-06 | □ | 200 | Rubber |
| TF-07 | ○ | | |
| TF-10 | △ | | |

SCREW REMOVAL

SCISSORS

NIPPERS

PLIERS

CRIMPING STRIPPING

TWEEZERS

SCREW DRIVERS

SPECIAL DRIVERS

WRENCHES

CUTTING PROCESSING

SETS CASES

SOLDERING EQUIPMENT

ESD CHEMICALS

TF-11~45

High performance, Rust-resistant, Black coated files

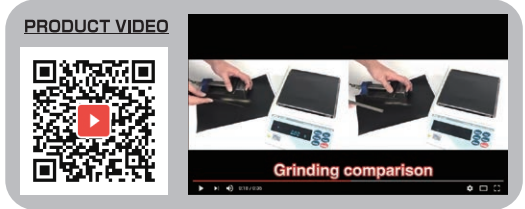

| (mm) | | | | | |
|----------|-------|------------|--------------|-------------|---------|
| Item No. | Shape | Coarseness | Blade length | O.A. length | Wgt (g) |
| TF-11 | □ | Second-cut | | 215 | 58 |
| TF-12 | △ | | | | 59 |
| TF-13 | ○ | | | | 41 |
| TF-14 | □ | | | | 52 |
| TF-15 | △ | | | | 56 |
| TF-21 | □ | #3 | 100 | 200 | 21 |
| TF-22 | △ | | | | 18 |
| TF-23 | ○ | | | | 16 |
| TF-24 | □ | | | | 19 |
| TF-25 | △ | | | | 17 |
| TF-31 | □ | Smooth-cut | | 215 | 58 |
| TF-32 | △ | | | | 61 |
| TF-33 | ○ | | | | 40 |
| TF-34 | □ | | | | 55 |
| TF-35 | △ | | | | 58 |
| TF-41 | □ | Second-cut | 175 | 325 | 166 |
| TF-42 | △ | | | | 153 |
| TF-43 | ○ | | | | 109 |
| TF-44 | □ | | | 325 | 112 |
| TF-45 | △ | | | | 166 |

ORDINARY FILES
Clogged with filing debris

Burr on each file tooth is eliminated before black coating, good for high and lasting performance of filing.

Sharp edge of teeth

Rust-resistant black coating

Side face
Smooth machined surface, ideal for filing a corner without damage. (TF-11, 21, 31, 41 only)

TFS-07·10·20·30 **RoHS JET BLACK FILE SET**

● A set of Jet Black Files in a roll-up storage with a strap



TFS-10 W240×L240(mm) W50×L240×H50(mm)

| Item No. | Shape | | | | | Brush | Coarseness | Blade length | O.A.length | Wgt (g) |
|----------|-------|-------|-------|-------|-------|-------|------------|--------------|------------|---------|
| | □ | △ | ○ | □ | △ | | | | | |
| TFS-07 | TF-11 | TF-12 | TF-13 | □ | △ | - | Second-cut | 100 | 215 | 274 |
| | TF-21 | TF-22 | TF-23 | - | - | | | | | |
| TFS-10 | TF-11 | TF-12 | TF-13 | TF-14 | TF-15 | ○ | Second-cut | 100 | 215 | 349 |
| TFS-20 | TF-21 | TF-22 | TF-23 | TF-24 | TF-25 | ○ | Precision | 100 | 200 | 170 |
| TFS-30 | TF-31 | TF-32 | TF-33 | TF-34 | TF-35 | ○ | Second-cut | 100 | 215 | 371 |

TFS-01·02 **RoHS FILE SET**

NORMAL TYPE



TFS-01 TFS-02 (TF-06~10)

| Item No. | Contents | □ | △ | ○ | □ | △ | Length(mm) |
|----------|----------|---|---|---|---|---|------------|
| TFS-01 | 5 | ● | ● | ● | ● | ● | 180 |
| TFS-02 | 5 | ● | ● | ● | ● | ● | 200 |

Sets and Cases



ENGINEER.

Even one of my belongings I replace on policy.
It is neither function nor design only. I represent to create myself
with an intellectual acting properties.

KS-01

 MY KIT

- Pocketable & reasonable kit for daily use



Set of 7 items

| | | |
|--------|-------------------------|-------|
| NSX-04 | Micro nippers | 115mm |
| PS-O4 | Miniature pliers | 115mm |
| PTS-01 | Tweezers | 125mm |
| DM-22 | ⊕Precision driver #3/0 | |
| DM-33 | ⊖Precision driver 1.8mm | |

| | | |
|-------|--------------|--------|
| DS-03 | ⊕Screwdriver | #00 |
| DS-13 | ⊖Screwdriver | 2.6×75 |

- Case : 135×90×30mm
- Weight : 0.25kg

KS-02

 MY KIT

- Simple & basic tool kit



Set of 11 items

| | | |
|--------|----------------------------|-------|
| NS-03 | Micro nippers | 125mm |
| PS-01 | Miniature long nose pliers | 125mm |
| PTS-01 | Tweezers | 125mm |
| DS-03 | ⊕Screwdriver | #00 |
| DS-23 | ⊕Screwdriver | #0 |
| DS-33 | ⊖Screwdriver | 4×75 |

| | | |
|-------|------------------|-------|
| DH-15 | Hex driver | 1.5mm |
| DH-20 | Hex driver | 2.0mm |
| DH-25 | Hex driver | 2.5mm |
| | File(Half-round) | |
| | Cutter knife, S | |

- Case : 220×145×35mm
- Weight : 0.5kg

KS-20

 MY KIT

- Pocket-sized and functional tool kit
- with Circuit testing driver handle



Set of 12 items

| | | |
|--------|--------------------|--------|
| NN-45 | Slant edge nippers | 125mm |
| PR-15 | Long nose pliers | 125mm |
| PTS-01 | Tweezers | 125mm |
| | Phillips bit | ⊕#00 |
| | Phillips bit | ⊕#1 |
| | Phillips bit | ⊕#2 |
| | Slotted bit | ⊖2.5mm |
| | Slotted bit | ⊖3.5mm |
| | Slotted bit | ⊖5.5mm |
| | Hex nut bit | ⊖5.5mm |
| | Awl (square) | |
| | Cutter knife (S) | |

- Case : 160×90×35mm
- Weight: 0.5kg



Circuit testing handle
(AC80~250V/DC100~300V)

KS-27

 MY KIT

- Pocket-sized tool kit, ideal for electronics
- with Penlight & Circuit testing driver



Set of 13 items

| | | |
|--------|----------------------------|--------|
| NS-03 | Micro nippers | 125mm |
| PS-01 | Miniature long nose pliers | 125mm |
| PT-06 | Tweezers (J) | 120mm |
| | Phillips bit | ⊕#1 |
| | Phillips bit | ⊕#2 |
| | Slotted bit | ⊖3.5mm |
| | Slotted bit | ⊖5.5mm |
| DM-22 | ⊕Precision driver | #000 |
| DM-24 | ⊕Precision driver | #0 |
| DM-32 | ⊕Precision driver | 1.2mm |
| DM-34 | ⊖Precision driver | 2.3mm |
| TWH-01 | Hex key wrench set | |
| | Mini penlight (AAA type) | |

- Case : 160×90×35mm
- Weight: 0.6kg



Circuit testing handle
(AC80~250V/DC100~300V)

KS-05 MAINTENANCE KIT

- For field maintenance service
- Environment-friendly polyester-made case (Lining: made of nylon)



with strap (detachable)

Elastic band

Set of 13 items

| | | | | | |
|-------|-----------------------|--------|--------|-------------------------|-------|
| NK-15 | Diagonal nippers | 125mm | PTS-01 | Tweezers | 125mm |
| PR-16 | Long nose pliers | 150mm | TWH-01 | Hex key wrench set | |
| PC-06 | Combination pliers | 150mm | SKC-30 | Soldering iron | 26W |
| DS-03 | ⊕Screwdriver | #00 | SW-30 | Solder | 20g |
| DS-23 | ⊕Screwdriver | #0 | | File (flat) | |
| DS-64 | ⊕Screwdriver | #2 | | Case : 255 × 150 × 50mm | |
| DS-33 | ⊖Screwdriver | 4 × 75 | | ●Weight : 1kg | |
| DA-02 | Alignment screwdriver | 150mm | | | |

⚡ Soldering Iron [220V~240V] available by assortment of SKC-30 as per Page 71

KSC-05 MAINTENANCE KIT

Cordless soldering iron (with Multi-holder) expands the utility of traditional tool kits.

- For field maintenance service
- Environment-friendly polyester-made case (Lining: made of nylon)

Iron stand,
hanger & magnet,
3-in-1

with strap (detachable)

Elastic band



Cordless soldering iron

Set of 14 items

| | | | | | |
|-------|-----------------------|--------|--------|--------------------------------|-------|
| NK-15 | Diagonal nippers | 125mm | PTS-01 | Tweezers | 125mm |
| PR-16 | Long nose pliers | 150mm | TWH-01 | Hex key wrench set | |
| PC-06 | Combination pliers | 150mm | SK-60 | Cordless soldering iron(w/cap) | |
| DS-03 | ⊕Screwdriver | #00 | SK-66 | Hot blow tip | |
| DS-23 | ⊕Screwdriver | #0 | SW-30 | Solder | 20g |
| DS-64 | ⊕Screwdriver | #2 | | File (flat) | |
| DS-33 | ⊖Screwdriver | 4 × 75 | | Case : 255 × 150 × 50mm | |
| DA-02 | Alignment screwdriver | 150mm | | ●Weight : 1kg | |

●Case : 255 × 150 × 50mm
●Weight : 1kg

KS-06(KSE-06) MAINTENANCE KIT

- For field maintenance service (Complete Set)



Set of 20 items

| | | | | | |
|--------|-----------------------|-----------|--------|-----------------------------|-------|
| NN-46 | Slant edge nippers | 150mm | SKC-40 | Soldering iron | 32W |
| PR-16 | Long nose pliers | 150mm | SW-30 | Solder | 20g |
| PD-06 | Side cutting pliers | 150mm | TWM-02 | Adjustable angle wrench | 200mm |
| PC-06 | Combination pliers | 150mm | | File (flat) | |
| PTS-02 | Tweezers | 125mm | | File (round) | |
| DS-03 | ⊕Screwdriver | #00 | TM-04 | Steel rule | 150mm |
| DS-23 | ⊕Screwdriver | #0 | TWH-04 | Hex key wrench set (8 pcs.) | |
| DS-64 | ⊕Screwdriver | #2 | | Cutter knife (S) | |
| DS-13 | ⊖Screwdriver | 2.6 × 75 | | Case : 305 × 220 × 45mm | |
| DS-54 | ⊖Screwdriver | 5.5 × 100 | | ●Weight : 2kg | |
| DN-05 | Nut driver | 5.5mm | | ⊕KSE-06 Case only | |
| DA-02 | Alignment screwdriver | 150mm | | | |

⚡ Soldering Iron [220V~240V] available by assortment of SKC-30 as per Page 71

KSC-06 MAINTENANCE KIT

Cordless soldering iron (with Multi-holder) expands the utility of traditional tool kits.

- For field maintenance service (Complete Set)



Set of 21 items

| | | | | | |
|--------|-----------------------|-----------|--------|--------------------------------|-------|
| NN-46 | Slant edge nippers | 150mm | SK-60 | Cordless soldering iron(w/cap) | |
| PR-16 | Long nose pliers | 150mm | SK-66 | Hot blow tip | |
| PD-06 | Side cutting pliers | 150mm | SW-30 | Solder | 20g |
| PC-06 | Combination pliers | 150mm | TWM-02 | Adjustable angle wrench | 200mm |
| PTS-02 | Tweezers | 125mm | | File (flat) | |
| DS-03 | ⊕Screwdriver | #00 | | File (round) | |
| DS-23 | ⊕Screwdriver | #0 | TM-04 | Steel rule | 150mm |
| DS-64 | ⊕Screwdriver | #2 | TWH-04 | Hex key wrench set (8 pcs.) | |
| DS-13 | ⊖Screwdriver | 2.6 × 75 | | Cutter knife (S) | |
| DS-54 | ⊖Screwdriver | 5.5 × 100 | | Case : 305 × 220 × 45mm | |
| DN-05 | Nut driver | 5.5mm | | ●Weight : 2kg | |
| DA-02 | Alignment screwdriver | 150mm | | | |

●Case : 305 × 220 × 45mm
●Weight : 2kg



Cordless soldering iron

KS-03(KSE-03)

TOOL KIT

- General electronic & job training use



■Set of 12 items

| | | |
|--------|-----------------------|-------|
| NN-45 | Slant edge nippers | 125mm |
| PR-16 | Long nose pliers | 150mm |
| DS-03 | ⊕Screwdriver | #00 |
| DS-23 | ⊕Screwdriver | #0 |
| DS-64 | ⊕Screwdriver | #2 |
| DS-33 | ⊖Screwdriver | 4×75 |
| DA-01 | Alignment screwdriver | 100mm |
| PTS-01 | Tweezers | 125mm |
| | Soldering iron | 30W |
| | Solder | |
| | Solder paste | |
| | Soldering stand | |

- Case : 240×115×45mm
- Weight : 0.8kg

◊ KSE-03 Case only

⚡ Soldering Iron [220V~240V] available by assortment of SK-14 as per Page 71

KS-04(KSE-04)

TOOL KIT

- General electronic & job training use
- Environment-friendly polyester-made case (Lining: made of nylon)



with strap (detachable)

Elastic band

■Set of 14 items

| | | | | | |
|-------|---------------------|-------|--------|------------------|-------|
| NN-45 | Slant edge nippers | 125mm | DN-05 | Nut driver | 5.5mm |
| PR-16 | Long nose pliers | 150mm | PTS-02 | Tweezers | 125mm |
| PD-06 | Side cutting pliers | 150mm | SKC-30 | Soldering iron | 26W |
| DS-03 | ⊕Screwdriver | #00 | | Solder | |
| DS-23 | ⊕Screwdriver | #0 | | Solder Paste | |
| DS-64 | ⊕Screwdriver | #2 | | Soldering stand | |
| DS-33 | ⊖Screwdriver | 4×75 | | Cutter knife (S) | |

- Case : 255×150×50mm
- Weight : 1.1kg

◊ KSE-04 Case only

⚡ Soldering Iron [220V~240V] available by assortment of SKC-30 as per Page 71

KSC-04

TOOL KIT

Cordless soldering iron (with Multi-holder) expands the utility of traditional tool kits.

- General electronic & job training use
- Environment-friendly polyester-made case (Lining: made of nylon)



Iron stand, hanger & magnet, 3-in-1

with strap (detachable)

Elastic band

◊ Cordless soldering iron

■Set of 15 items

| | | | | | |
|--------|---------------------|-------|-------|--------------------------------|------|
| NN-45 | Slant edge nippers | 125mm | DS-33 | ⊖Screwdriver | 4×75 |
| PD-06 | Side cutting pliers | 150mm | SK-60 | Cordless soldering iron(w/cap) | |
| PR-16 | Long nose pliers | 150mm | SK-66 | Hot blow tip | |
| PTS-02 | Tweezers | 125mm | | Solder | |
| DN-05 | Nut driver | 5.5mm | | Solder Paste | |
| DS-03 | ⊕Screwdriver | #00 | | Soldering stand | |
| DS-23 | ⊕Screwdriver | #0 | | Cutter knife (S) | |
| DS-64 | ⊕Screwdriver | #2 | | | |

- Case : 255×150×50mm
- Weight : 1.1kg

KS-08

ELECTRONICS KIT

- For electronics, PC maintenance, PC modification, etc.
- Environment-friendly polyester-made case (Lining: made of nylon)



■Set of 21 items

| | | |
|--------|----------------------------|--------|
| NS-03 | Micro nippers | 125mm |
| PS-01 | Miniature long nose pliers | 125mm |
| PTS-01 | Tweezers | 125mm |
| SS-01 | Solder sucker | |
| SS-08 | IC extractor | |
| SS-22 | Spring hook | |
| | Soldering iron | 30W |
| SL-02 | Inspection mirror | |
| SWU-04 | Solder wick | 2.8mm |
| | Solder (1m) | |
| TWH-01 | Hex key wrench set | |
| DN-05 | Nut driver | 5.5mm |
| DM-22 | ⊕Precision driver | #000 |
| DM-33 | ⊖Precision driver | 1.8mm |
| | Phillips bit | ⊕#00 |
| | Phillips bit | ⊕#0 |
| | Phillips bit | ⊕#1 |
| | Phillips bit | ⊕#2 |
| | Slotted bit | ⊖3.5mm |
| | Cutter knife (S) | |
| | File (half-round) | |

- Case : 255×150×50mm
- Weight : 1.0kg

KS-14

- For electronics, office automation maintenance, etc.
- Environment-friendly polyester-made case (Lining: made of nylon)

■ Set of 18 items

| | | |
|--------|----------------------|--------|
| NS-03 | Micro nippers | 125mm |
| PR-16 | Long nose pliers | 150mm |
| PTS-01 | Tweezers | 125mm |
| PZ-56 | Screw removal pliers | 175mm |
| DP-03 | Pro-use driver | ⊕#00 |
| DP-24 | Pro-use driver | ⊕#0 |
| DP-64 | Pro-use driver | ⊕#2 |
| DP-34 | Pro-use driver | ⊖4.3mm |
| DN-05 | Nut driver | 5.5mm |
| | Mini spanner | 5.5×6 |
| | Mini spanner | 8×9 |
| TM-04 | Steel rule | 150mm |
| TZ-05 | Scriber | 220mm |
| TWH-01 | Hex key wrench set | |
| TWM-03 | Smart monkey wrench | 150mm |
| SL-02 | Inspection mirror | |
| | Cutter knife (S) | |
| | File (half-round) | |

- Case : 250×180×50mm
- Weight : 1.3kg

KS-28(KSE-28)

TOOL KIT

Basic assortment of general purpose tools and free space in mesh pocket for your own use

- Soft touch EVA plastic case with double panel
- A4 size pocket is provided on the reverse of upper panel which is capable of documents, measuring instrument or notebook P.C. (max. 40mm thick)
- Tool panel is easily detachable with hook, which is convenient for field work.



330mm wide pocket on the reverse



● Free space in mesh pocket

● Clear pocket (detachable)

■ KS-28 Set of 22 items

| | | |
|--------|------------------------|----------|
| NN-46 | Slant edge nippers | 150mm |
| PR-16 | Long nose pliers | 150mm |
| PD-06 | Side cutting pliers | 150mm |
| PZ-55 | Screw removal pliers | 150mm |
| PW-08 | Pump pliers | 200mm |
| PTS-01 | Tweezers | 125mm |
| DA-01 | Alignment driver | 100mm |
| DKD-01 | Circuit testing driver | |
| DN-05 | Nut driver | 5.5mm |
| DG-05 | ⊕/⊖ Cushion driver | #2/⊖6 |
| DG-21 | ⊖ Mini soft driver | 3×100mm |
| DG-24 | ⊕ Mini soft driver | #0×100mm |

| | | |
|--------|-------------------------|-------|
| SKC-30 | Soldering iron | 26W |
| SS-05 | Tip cleaner with stand | |
| SW-30 | Solder | 20g |
| | File (half-round) | |
| | Measuring tape | 2m |
| TS-05 | Open-End wrench set | |
| TWH-01 | Hex key wrench set | |
| TWM-02 | Adjustable angle wrench | 200mm |
| | Cutter knife (S) | |
| | Vinyl tape | |

- Case : 405×306×100mm (Ext.)
380×276×73mm (Int.)
- Weight : 3.7kg

◇ [KSE-28] Case and panel 1.8kg

⚡ Soldering Iron [220V~240V] available by assortment of SKC-30 as per Page 71

OPTION  Cordless Soldering Iron can be assorted instead of SKC-30 at customer's option.

KS-11 (KSE-11)

TOOL KIT

Field service and maintenance of production lines & machinery

KS-11 (Tool kit)

KSE-11 (Case and panel only) - Net 5 kg



■ Set of 60 items

| | | |
|--------|---------------------------|-------------|
| NS-03 | Micro nippers | 125mm |
| NN-46 | Slant edge nippers | 150mm |
| PS-01 | Miniature pliers | 125mm |
| PR-46 | Needle nose pliers | 150mm |
| PD-06 | Side cutting pliers | 150mm |
| PC-06 | Combination pliers | 150mm |
| PW-10 | Pump pliers | 250mm |
| PA-01 | Wire pliers | |
| PT-01 | Tweezers | 125mm |
| PH-03 | Lock holder | 150mm |
| PH-33 | Electronic snips | 145mm |
| DS-03 | ⊕Screwdriver | #00 |
| DS-24 | ⊕Screwdriver | #0 |
| DS-44 | ⊕Screwdriver | #1 |
| DS-64 | ⊕Screwdriver | #2 |
| DS-13 | ⊖Screwdriver | 2.6×75 |
| DS-34 | ⊖Screwdriver | 4×100 |
| DA-02 | Alignment driver | 150mm |
| DM-22 | ⊕Precision driver | #3/0 |
| DM-23 | ⊕Precision driver | #00 |
| DM-33 | ⊖Precision driver | 1.8mm |
| DM-34 | ⊖Precision driver | 2.3mm |
| DZ-24 | Screw-holding driver | #0 |
| DG-12 | Long pro-grip driver | #2×250mm |
| DN-02 | Nut driver | 4mm |
| DN-04 | Nut driver | 5mm |
| DN-05 | Nut driver | 5.5mm |
| DN-07 | Nut driver | 7mm |
| DN-08 | Nut driver | 8mm |
| DR-04 | Ratchet stubby driver set | |
| DZ-08 | Offset driver set | |
| TWM-02 | Adjustable angle wrench | 200mm |
| TS-05 | Mini spanner set (5 pcs.) | |
| TR-03 | Taper reamer | 20mm |
| | Hammer | |
| | Measuring tape | 2m |
| TWH-01 | Hex key wrench set | |
| TWS-02 | Socket wrench set | |
| TFS-02 | File set | |
| TZ-02 | Handy saw | |
| SKC-40 | Soldering iron | 32W |
| SW-31 | Solder | 150g |
| SS-05 | Tip cleaner with stand | |
| SS-02 | Solder sucker | |
| SS-08 | IC Extractor | |
| SS-21 | Spring hook | |
| SS-22 | Spring hook | |
| SL-03 | Inspection mirror | |
| TP-35 | Magnetic pick-up tool | |
| KP-03K | Parts box | |
| SWU-04 | Solder wick | 2.8mm |
| | Vinyl tape | |
| | Pen light | |
| | Cutter knife (L) | |
| ZC-19 | Oil | 20cc |
| | Flat brush | |
| | Poly bottle | 50cc/2pcs. |
| | Poly bottle | 100cc/2pcs. |
| | Silicon cloth | |
| SD-10 | Digital Multimeter | |

- Aluminum Case : 455×330×176 (Ext.) 440×315×168 (Int.)
- Weight : 12kg

⚡ Soldering Iron [220V~240V] available by assortment of SKC-30 as per Page 71

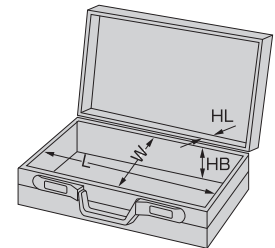

H=HL+HB



KS-12

ATTACHE TOOL KIT

Stylish and functional tool kit



■ Set of 25 items

| | | |
|--------|----------------------------|---------|
| NS-03 | Micro nippers | 125mm |
| PS-01 | Miniature pliers | 125mm |
| PD-06 | Side cutting pliers | 150mm |
| PTS-01 | Tweezers | 125mm |
| DA-51 | Ceramic alignment driver | |
| DG-21 | ⊖Mini soft driver | 3×0.4 |
| DG-22 | ⊕Mini soft driver | #00 |
| DG-24 | ⊕Mini soft driver | #0 |
| DG-01 | ⊖Pro grip driver | 5.5×0.7 |
| DG-04 | ⊕Pro grip driver | #2 |
| DST-05 | ⊕⊖Reversible stubby driver | #2/⊖6.3 |
| SD-10 | Digital multimeter | |
| SKC-30 | Soldering iron | 26W |
| SS-02 | Solder sucker | |
| SS-08 | IC extractor | |
| SS-10 | PCB connector extractor | |
| SW-30 | Solder | 20g |
| TWM-03 | Smart monkey wrench | 150mm |
| TWH-04 | Hex key wrench set | |
| TS-05 | Mini spanner set (5 pcs.) | |
| TM-04 | Steel rule | 150mm |
| PA-06 | Wire stripper | |
| SWU-04 | Solder wick | 2.8mm |
| SL-50 | Pocket loupe | |
| | Cutter knife (S) | |

● Dividing plate for soldering box & tester



| Item No. | L | W | H | HL | HB | Weight(kg) | Color |
|----------|--------------|--------------|--------------|------|------|------------|-------|
| KS-12 | 465 (450) | 345 (320) | 129 (105) | (35) | (70) | 6 | Black |

() : Internal size

⚡ Soldering Iron [220V~240V] available by assortment of SKC-30 as per Page 71

KSE-12

iRoHS ATTACHE CASE WITH EMPTY PANEL

- Neatly designed for a stylish appearance
- Incorporating empty tool panel and document pocket



Dividing panel is easily detachable with Velcro.

- Speedy and easy attachment of empty panel

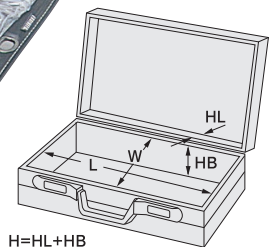

$$H=HL+HB$$

(mm)

| Item No. | L | W | H | HL | HB | Weight(kg) | Color |
|----------|--------------|--------------|--------------|------|------|------------|-------|
| KSE-12 | 465 (450) | 345 (320) | 129 (105) | (35) | (70) | 3.3 | Black |

() : Internal size

KA-22

iRoHS ATTACHE CASE (WIDE TYPE)

Attractive and functional multipurpose case

- Light-weighted & durable case made of ABS resin
- Nylon 100% (Hypalon) interior finish for more than just business
- Tool panel (option) can be hidden from free space by dividing plate.
- Comes with multipurpose pockets

BODY

This handsome case is molded of ABS plastic with simple form line, lightweight and durable construction. Suggest a new field of use and produce the joy in possession of the case.

DIAL LOCK

Add security with combination dial lock and two pushing locks. Open easily by sliding outside the 2 buttons.



INSIDE

Besides business use, add functional and fashionable pockets and storage pouch to meet multipurpose requirements. Offer clear see-through mesh type pocket at the back of dividing plate.

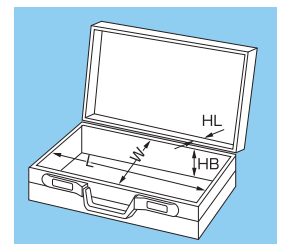

(Remark)

The dimensions indicate the internal sizes but subject to within a tolerance allowed.
H=HL+HB



HANDLE

Designed to fit the hand and reduce hand fatigue.

| Item No. | L | W | H | HL | HB | Weight(kg) | Color |
|----------|-----|-----|-----|----|----|------------|-------|
| KA-22 | 450 | 320 | 105 | 35 | 74 | 2.4 | Black |

(mm)

SCREW REMOVAL

SCISSORS

NIPPERS

PLIERS

CRIMPING STRIPPING

TWEEZERS

SCREW DRIVERS

SPECIAL DRIVERS

WRENCHES

CUTTING PROCESSING

SETS CASES

SOLDERING EQUIPMENT

ESD CHEMICALS

KA-15

RoHS ABS ATTACHE CASE

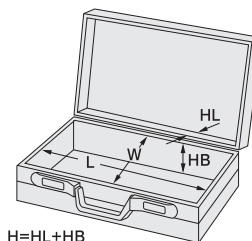

| (mm) | | | | | | |
|-------|-----|-----|----|----|----|------------|
| Item | L | W | H | HL | HB | Weight(kg) |
| KA-15 | 440 | 320 | 92 | 32 | 60 | 2 |

KA-50·51

RoHS ALUMINIUM CASE

- Featuring a matt surface in silver color
- Streamline appearance



● Durable handle

| Internal Size (mm) | | | | | | |
|--------------------|-----|-----|-----|----|----|------------|
| Item | L | W | H | HL | HB | Weight(kg) |
| KA-50 | 440 | 320 | 105 | 40 | 65 | 2.6 |
| KA-51 | 440 | 320 | 130 | 50 | 80 | 2.8 |

KA-57

RoHS ALUMINIUM CASE

- Stylish case coming with shock-proof sponges and tool panel



Wavy formed urethane (upper shell) and cut sponges (body) protect contents such as camera, camcorder, etc.

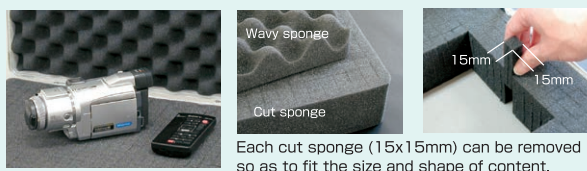

| External dimensions (Internal dimensions) (mm) | | | | | | | |
|------------------------------------------------|----------|----------|----------|------|------|---------------------|------------|
| Item No. | L | W | H | HL | HB | Tool Panel (single) | Weight(kg) |
| KA-57 | 450(435) | 330(314) | 135(120) | (52) | (68) | 420×300 | 4.1 |

KA-30·42~44

ALUMINIUM CASE

- Heavy-duty type
- Made of 1.5mm-thick rugged aluminium of anodized finish
- All the corners reinforced with aluminum frame and rivets
- Case inside in melton finish



●Durable handle



KA-30

KA-44



Water-repellent, anti-static or cleanroom type is available at option.



KA-44 is originally equipped with casters. Other models can be equipped with casters at option.

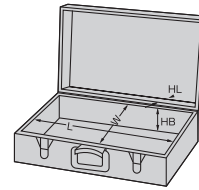

(Remark)
The dimensions indicate the internal sizes but subject to within a tolerance allowed.
H = HL+HB

| Item No. | Internal Size (mm) | | | | | (kg) | |
|----------|--------------------|-----|-----|----|-----|------|----------|
| | L | W | H | HL | HB | Wgt. | Max.Load |
| KA-30 | 440 | 315 | 165 | 55 | 110 | 4.3 | 15 |
| KA-42 | 540 | 320 | 160 | 50 | 110 | 4.6 | |
| KA-43 | 590 | 410 | 205 | 50 | 155 | 6.2 | 20 |
| KA-44 | 650 | 450 | 197 | 60 | 137 | 7.4 | |

KAC-30·42

ALUMINIUM CASE FOR CLEANROOM

- Constructed of aluminum sheets without any accessories nor material generating dust
- KAC-42 is ideal for storage of precision instruments in cleanroom



KAC-30

KAC-42



●Durable handle

| Item No. | Internal Size (mm) | | | | | (kg) | |
|----------|--------------------|-----|-----|----|-----|------|----------|
| | L | W | H | HL | HB | Wgt. | Max.Load |
| KAC-30 | 440 | 315 | 165 | 55 | 110 | 4 | 15 |
| KAC-42 | 540 | 320 | 160 | 50 | 110 | 4.7 | |

KA-54

ALUMINIUM ATTACHE CASE

- Featuring a glossy surface in black color Streamline appearance



| Item | (mm) | | | | | |
|-------|------|-----|-----|----|----|------------|
| | L | W | H | HL | HB | Weight(kg) |
| KA-54 | 440 | 320 | 130 | 50 | 80 | 2.8 |

SCREW REMOVAL

SCISSORS

NIPPERS

PLIERS

CRIMPING STRIPPING

TWEEZERS

SCREW DRIVERS

SPECIAL DRIVERS

WRENCHES

CUTTING PROCESSING

SETS CASES

SOLDERING EQUIPMENT

ESD CHEMICALS

KP-01~03(KP-95~97)

Durable transparent box, ideal for transporting, classification and storage of small parts.

- Lightweight, compact and durable component box made of polypropylene
- Interchangeable dividing plates can be configured to create storage space
- See-through, transparent box.
- With article labels.

- ◇ Optional dividing plate set
 KP-95 : 6 pcs./set adaptable to KP-01
 KP-96 : 6 pcs./set adaptable to KP-02
 KP-97 : 6 pcs./set adaptable to KP-03



- KP-01
 Ext. Size : 157×102×42mm
 4 pcs. of dividing plates included



- KP-02
 Ext. Size : 207×145×40mm
 12 pcs. of dividing plates included



- KP-03
 Ext. Size : 255×190×40mm
 16 pcs. of dividing plates included

KP-02K·03K(KP-96·97)

Heavy duty transparent parts box, ideal for classification and storage

- Super clear transparent lid owing to shock-proof polycarbonate resin
- Micro-rib system of divider setting
- Material: Lid - Polycarbonate
 Body & Divider - Polypropylene
 Latch - ABS resin

- ◇ Optional dividing plate set
 KP-96 : 6 pcs./set adaptable to KP-02K
 KP-97 : 6 pcs./set adaptable to KP-03K



- KP-02K
 Ext. Size : 205×145×40mm
 18 pcs. of dividers included

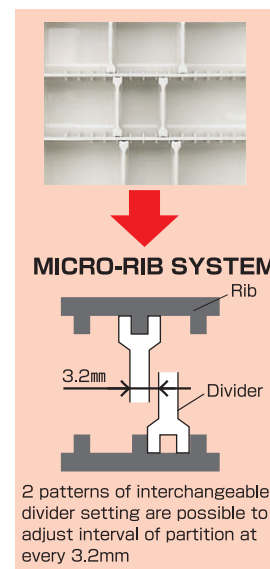

- KP-03K
 Ext. Size : 255×190×40mm
 32 pcs. of dividers included

KP-04  **MINIATURE BOX**

- Most suitable for electronic parts and other small components.
- Compact, lightweight and portable.
- Material: Styrene resin(lid), Polypropylene (body).
- External Size: 120×92×25mm

KP-51·52  **IC STORAGE BOX**

- Compact IC storage box made of anti-static plastic body
- Comes with 10mm-thick high density conductive foam (Surface resistivity less than $5 \times 10^6 \Omega$)



- KP-51
 ● External Size : 80×135×25
 ● Internal Size : 75×130×19



- KP-52
 ● External Size : 230×145×28
 ● Internal Size : 219×134×22

Soldering Equipment



SK-30/40SERIES

SOLDERING IRON

Excellent built-in ceramic heater. Compact & light-weight design suitable for accurate soldering operations

- High efficient ceramic heater permits quick heat-up, enabling soldering operation only in about 1 minute.
- The use of a small connector connecting heater and power cord permits exchange of heaters with one touch.
- Short length from grip to tip for easy operation
- Screw type tip permits easy exchange of tips.
- Perfect for accurate soldering operation with sharp soldering tip (long life and non corrosive).
- With heat-resistance cap for handy storage after use. (SKC-30/31/32/40/41)

■ SK-30~41

Grip made of reinforced glass fiber resin.

SK-30



■ SKC-30~41

With Heat-Resistant Cap.

SKC-32



SK-30/40SERIES Three functions

1



Sharp iron tip
(Long life & durable type)

2



Special stainless steel Plug-in type heater for inside tip for prevention against sticking and loosening of the tip

3

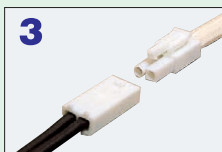

■ Time/Temp. Chart

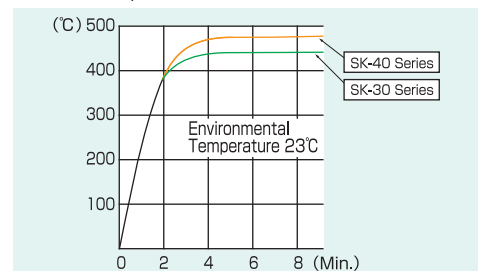

SK-30 SERIES

■ Specification

| Item No. | Max. Tip Temp. | Watt | Tip | L'gth | Wgt(g) | Rated Voltage | Insulation Resistance |
|----------|----------------|------|-------|-------|--------|---------------|-----------------------|
| SK-30 | 400°C | 26W | ST-10 | 202mm | 130 | 100V | 100MΩ |
| SKC-30 | | | ST-11 | | | | |
| SKE-30 | | | ST-14 | | | | |
| SK-31 | 440°C | 26W | ST-10 | 202mm | 130 | 100V | 100MΩ |
| SKC-31 | | | ST-11 | | | | |
| SKE-31 | | | ST-14 | | | | |
| SK-32 | 390°C | 26W | ST-10 | 202mm | 130 | 100V | 100MΩ |
| SKC-32 | | | ST-14 | | | | |

■ SKC with Heat-Resistant Cap. ■ SKE with 3-pin plug.

⚡ 220V 230V 240V are also available. REF. Page 71

Caution Ceramic heater is not elastic and may be broken by excess shock. Please refrain from beating and wrenching.

■ REPLACEMENT PARTS

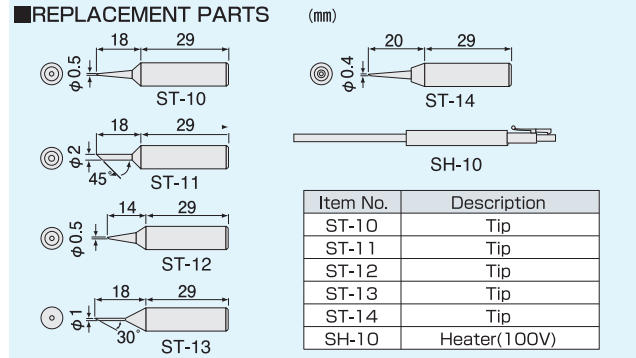

SK-40 SERIES

■ Specification

| Item No. | Max. Tip Temp. | Watt | Tip | L'gth | Wgt(g) | Rated Voltage | Insulation Resistance |
|----------|----------------|------|-------|-------|--------|---------------|-----------------------|
| SK-40 | 450°C | 32W | ST-20 | 204mm | 130 | 100V | 100MΩ |
| SKC-40 | | | ST-21 | | | | |
| SK-41 | 470°C | 32W | ST-20 | 204mm | 130 | 100V | 100MΩ |
| SKC-41 | | | ST-21 | | | | |

■ SKC with Heat-Resistant Cap.

Caution Ceramic heater is not elastic and may be broken by excess shock. Please refrain from beating and wrenching.

■ REPLACEMENT PARTS

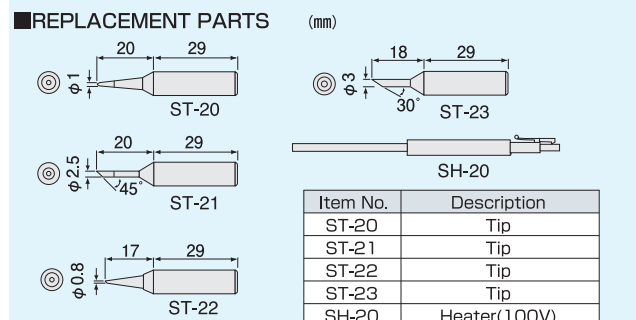

SK-30 SERIES

SOLDERING IRON

Excellent built-in ceramic heater. Compact & light-weight design suitable for accurate soldering operations

- High efficient ceramic heater permits quick heat-up, enabling soldering operation only in about 1 minute.
- The use of a small connector connecting heater and power cord permits exchange of heaters with one touch.
- Short length from grip to tip for easy operation
- Screw type tip permits easy exchange of tips.
- Perfect for accurate soldering operation with sharp soldering tip (long life and non corrosive).
- With heat-resistance cap for handy storage after use. (SKC-30/31)

■SK-30~31

Grip made of reinforced glass fiber resin.



■SKC-30~31

With Heat-Resistant Cap.



■SKE-30~31

With 3-Pin plug to avoid damage of elements caused by electric leakage.



SK-30SERIES Three functions

1



Sharp iron tip
(Long life & durable type)

2



Special stainless steel
inside tip for prevention
against sticking and
loosening of the tip

3



Plug-in type heater for
instant replacement

■Time/Temp. Chart

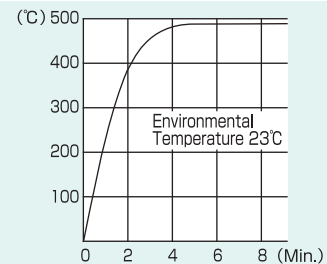

SK-30 SERIES

■Specification

| Item No. | Max. Tip Temp. | Watt | Tip | L'gth | Wgt(g) | Rated Voltage | Insulation Resistance |
|----------|----------------|------|-------|-------|--------|---------------|-----------------------|
| SK-30 | 445°C | 30W | ST-20 | 204mm | 130 | 220 240V | 100MΩ |
| SKC-30 | | | | | | | |
| SKE-30 | | | | | | | |
| SK-31 | 500°C | 30W | ST-21 | 204mm | 130 | 220 240V | 100MΩ |
| SKC-31 | | | | | | | |
| SKE-31 | | | | | | | |

■ST-22 Max. Tip Temp. 430°C ■ST-23 Max. Tip Temp. 500°C

Caution Ceramic heater is not elastic and may be broken by excess shock.
Please refrain from beating and wrenching.

■REPLACEMENT PARTS

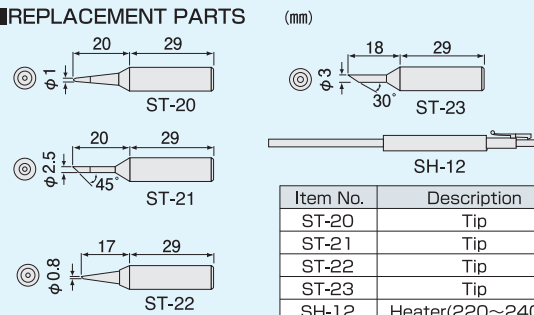

SCREW REMOVAL

SCISSORS

NIPPERS

PLIERS

CRIMPING STRIPPING

TWEEZERS

SCREW DRIVERS

SPECIAL DRIVERS

WRENCHES

CUTTING PROCESSING

SETS CASES

SOLDERING EQUIPMENT

ESD CHEMICALS

SK-60SERIES

Newly designed compact body with various functions!

- Perfect for in-field service and maintenance where accessibility may be limited.
- Light weight for fatigue free use.
- One touch ignition and super quick heat-up (equivalent up to 60 watts).
- More than one hour continuous use capacity.



Completely cordless assures no electric leakage, no E.M.I. and free from voltage problem.



Arts, craft, and hobby use such as plastic shaping and rope cutting.

Three-in-one heat tool with soldering, hot blow, and hot knife



- SKB-60 Contents**
- Body (SK-61 solder tip)
 - Hot blow tip
 - Hot knife tip
 - Multi-holder
 - Protective cap



- SKA-60 Contents**
- Body(SK-61 solder tip)
 - Hot blow tip
 - Multi-holder
 - Protective cap



Pin point accurate hot air for shrink tubing and plastic welding.

Kotelyzer(SK-60)Specifications

| System | | Gas Catalyst Reaction System |
|---------------------------------|----------------|------------------------------------------------------------|
| Thermal Output | Soldering Iron | 200°C~450°C (Equivalent to 15~60W electric soldering iron) |
| | Hot Blow | 650°C MAX |
| Gas Container Capa. | | 14ml |
| Operation Time for One Gas Fill | | Abt 1 hour 15min. |
| O.A. Length | | 216mm including cap |
| Weight | | 66g |



Two-in-one heat tool with soldering and hot blow.

- SKC-60 Contents**
- Body(SK-61 solder tip)
 - Hot blow tip
 - Protective cap
 - Cleaner stand

SK-60SERIES

REPLACEMENT PARTS

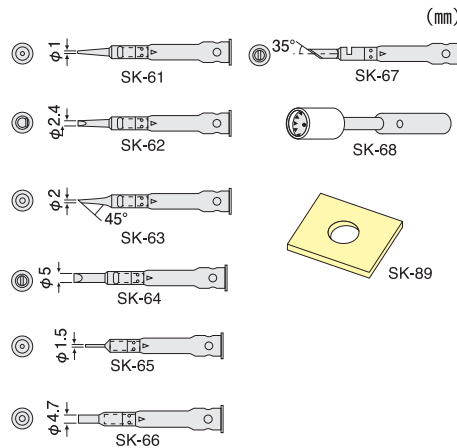

| Item No. | Description |
|----------|-----------------|
| SK-61 | Tapered needle |
| SK-62 | Chisel |
| SK-63 | φ2mm spade |
| SK-64 | Chisel |
| SK-65 | Hot blow tip |
| SK-66 | Hot blow tip |
| SK-67 | Hot knife |
| SK-68 | Ceramic unit |
| SK-89 | Cleaning sponge |

● Multi-Holder is not saleable separately.

SS-08

IC EXTRACTOR

- Ideal for extracting 8~42 pins ICs in one single operation.
- Squeeze clip and hold ICs tightly.
- Overall Length : 125mm



SS-10

PC BOARD CONNECTOR EXTRACTOR

- Ideal for insertion or extraction of housing connectors on the PC boards.
- Holds PC board connectors with accurately machined tip, picking them uprightly and smoothly without a cut of wire or deformity.
- Accurate tip design to insert or extract PCB connectors (straight type & right-angle type) mounted on dense PCB
- Overall Length : 112mm



SK-70SERIES

Multi-holder creates new field of cordless soldering iron!

- Perfect for in-field service and maintenance where instant heat is required.
- Super quick heat up with one touch operation.
- Completely cordless assures no electric leakage no E.M.I.
- Flameless and safe heat generating system by gas catalyst reaction.
- Variable temperature control (equivalent to 20-80 watts).

■ Telecommunication field

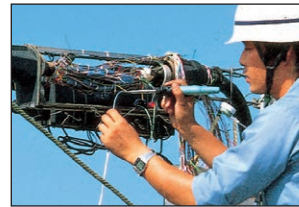

SKD-70 set comes with a high-power tip for cable maintenance tasks and an accurate tip for telephone office service.

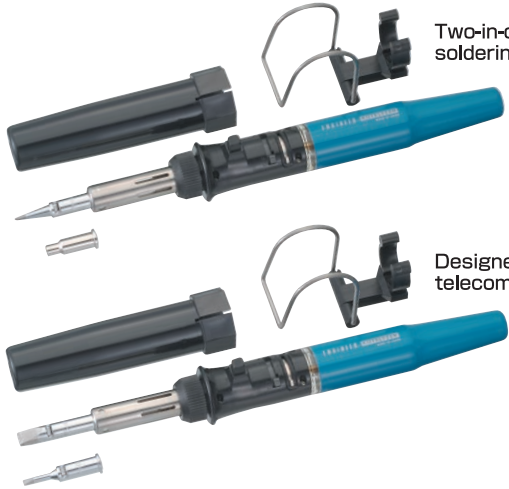

Two-in-one heat tool with soldering and hot blow.

- SKC-70 Contents
- Body(SK-71 solder tip)
 - Hot blow tip
 - Multi-holder
 - Protective cap

- SKA-70 Contents
- Body(SK-71 solder tip)
 - Hot blow tip
 - Protective cap

- SKB-70 Contents
- Body(SK-71 solder tip)
 - Hot blow tip

Designed to perform telecommunication tasks.

- SKD-70 Contents
- Body(SK-79 solder tip)
 - Solder tip(SK-72)
 - Multi-holder
 - Protective cap

■ Kotelyzer (SK-70) Specifications

| System | | Gas Catalyst Reaction System |
|---------------------------------|----------------|------------------------------------------------------------|
| Thermal Output | Soldering Iron | 200°C~500°C (Equivalent to 20~80W electric soldering iron) |
| | Hot Blow | 650°C MAX |
| Gas Container Capa. | | 28ml |
| Operation Time for One Gas Fill | | Abt 4 hours (Lever position : 2) |
| O.A.Length | | 281mm including cap |
| Weight | | 110g |

Three function of Multi-holder assures safe and wide task field !

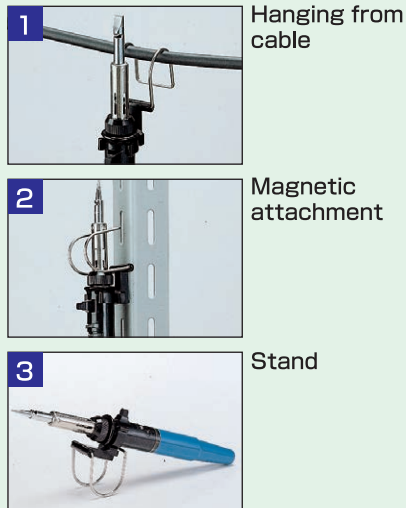

1 Hanging from cable

2 Magnetic attachment

3 Stand

Multi-Holder is useable for both SK-60 series and SK-70 series.

SK-70SERIES

REPLACEMENT PARTS

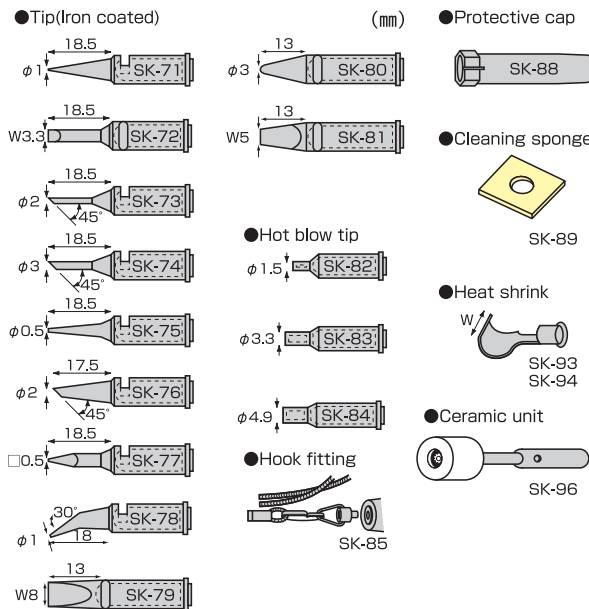

| Item No. | Description |
|----------|--------------------------------|
| SK-71 | Tapered needle |
| SK-72 | Chisel |
| SK-73 | φ2mm spade |
| SK-74 | φ3mm spade |
| SK-75 | Tapered needle |
| SK-76 | φ2mm spade |
| SK-77 | Tapered pyramid |
| SK-78 | Offset tapered needle |
| SK-79 | High powered chisel |
| SK-80 | High powered round head needle |
| SK-81 | High powered long taper chisel |
| SK-82 | Hot blow tip |
| SK-83 | Hot blow tip |
| SK-84 | Hot blow tip |
| SK-85 | Hook fitting |
| SK-88 | Protective cap |
| SK-89 | Cleaning sponge |
| SK-93 | Heat shrink W-22 |
| SK-94 | Heat shrink W-18 |
| SK-96 | Ceramic unit |

SKM-40·SK-42~47

HANDY KOTELYZER

SK-90·95

GAS REFILL

- Advanced and streamlined design
- Hot blow & powerful torch
- Improved heat-generating structure of metal catalyst
- Come with cleaner stand & solder
- Capable of continuous use in one hour

- Please use our original gas for refill. (Butane liquefied odorless gas for industry use)



■ Soldering Iron

■ Hot Blow

■ Torch

■ Specifications

| System | | Gas Catalyst Reaction System Pressure Gas Burning System (Torch) |
|---------------------------------|----------------|---------------------------------------------------------------------|
| Thermal Output | Soldering Iron | 200°C~500°C (Equivalent to 20~60W electric soldering iron) |
| | Hot Blow | 650°C MAX |
| | Torch | 1300°C MAX |
| Gas Container Capa. | | 12ml |
| Operation Time for One Gas Fill | | about 60 min. (Lever position: Middle) |
| O.A.Length | | 197mm Cap Included |
| Weight | | 74g |

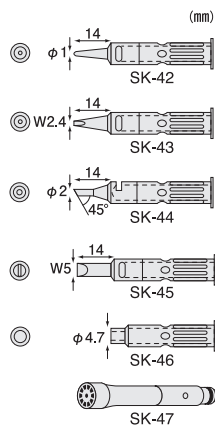

| Item No. | Description |
|----------|----------------|
| SK-42 | Tapered Needle |
| SK-43 | Chisel |
| SK-44 | φ2mm Spade |
| SK-45 | Chisel |
| SK-46 | Hot blow tip |
| SK-47 | Ejector Unit |



265ml



480ml

SS-15 2P-3P PLUG CONVERTER

- Converts 3P Plug with ground wire into 2P.

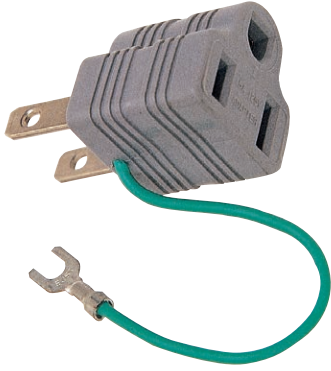
**ZC-70·71****FLUX/DISPENSER**

Ideal for rework of SMD solders.

- Pin-point accuracy with no spillage

- ZC-70
 - FLUX 50cc
 - FLUX DISPENSER
 - NEEDLE (Hole diam. 0.25/0.5mm) 1pce. each
 - CLEANING PIN 1pce. each

- ZC-71
 - FLUX DISPENSER (BOTTLE)
 - NEEDLE (Hole diam. 0.25/0.5mm) 1pce. each
 - CLEANING PIN 1pce. each

**SD-20(SD-21~26·SD-60~88)**

High-capacity ceramic heater and powerful motor, capable of suction and hot air blow.

- Built-in motor, diaphragm type vacuum pump, temperature adjustable circuit and indicator light.
- Low noise and low vibration due to floating mechanism.
- Minimum reaching time to the maximum vacuum and powerful suction capacity.
- Ideal for desoldering on 4-8 layered PCB's.
- No static damage to IC etc. due to carboniferous body.

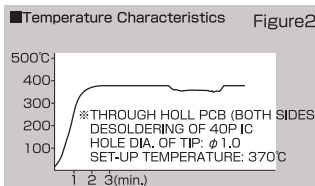
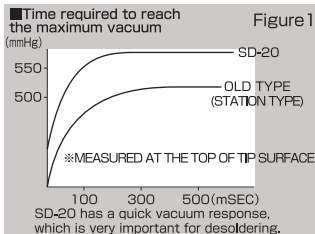
**REPLACEMENT PARTS**

| Item No. | DESCRIPTION |
|----------|------------------------------|
| SD-61 | TIP ϕ 0.8 |
| SD-62 | TIP ϕ 1.0 |
| SD-63 | TIP ϕ 1.5 |
| SD-87 | TAPERING SLIM TIP ϕ 0.8 |
| SD-88 | TAPERING SLIM TIP ϕ 1.0 |
| SD-21 | HEATER HOLER |
| SD-22 | HEATER ASSY |
| SD-23 | PIPE SETTER |
| SD-24 | FILTER CARTRIDGE (5pcs.) |
| SD-25 | SEAT VALVE |
| SD-26 | DIAPHRAGM |

Contents

- Carrying case
- Desoldering tool
- Spare tip (ϕ 1.5)
- Spare filter cartridge (2pcs.)
- Cleaning pin

SPECIFICATIONS

| | |
|---------------------------------------|--------------------------------|
| POWER SOURCE | AC100V · 50/60Hz |
| PUMP | DIAPHRAGM TYPE |
| MOTOR OUTPUT | 12W |
| VACUUM ATTAINED | 650mmHg |
| TIME REQUIRED TO REACH MAXIMUM VACUUM | 0.2 seconds |
| AIR FLOW RATE (OPEN) | 15 liter/min. |
| HEATER | 100W(Ceramic) |
| CONTROL SYSTEM | Feed back zero cross over type |
| TEMPERATURE RANGE | 350~500°C |
| TIP (HOLE DIA.) | 1.0 ϕ (STANDARD) |
| POWER SUPPLY CORD | 3P CORD (W GROUND) 1.8m |
| WEIGHT | 420g(excluding cord) |

TOOL STAND

SD-60

**DESOLDERING TOOL**

DESTINATIONS ARE LIMITED FOR EXPORT

INDICATOR LIGHT

When the heater is on, light goes on and when the temperature reaches set-up level, it flickers.

Temperature Adjustment Dial (350~500°C)

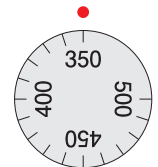
**SD-30(SD-29·31·86)****SMD ACCESSORY KIT**

- For easy removal of SMD components including QFP & SOP owing to Hot Blow function of SD-20

- Contents:
 - SD-29 Filter Pipe
 - SD-31 Stainless Wire Reel
 - SD-86 Hot Air Nozzle



SWS-06~12 SUPERIOT RMA SOLDER

No cleaning high performance resin core solder, highest grade flux construction

- Completely non-corrosive flux residue which requires no cleaning after soldering
- Everlasting and reliable bonding owing to non-conductive and non-absorbable residue
- Wide solder spread and wetting for speedy work
- Contains organic amine activated rosin to meet highest JIS grade & MIL-RMA.



SWA-06~12 SUPERIOT RA SOLDER

No cleaning high performance resin core solder for soldering stainless steel

- Non-corrosive flux residue featuring everlasting bonding
- Featuring stable bonding owing to non-conductive and non-absorbable residue
- Continuous and high performance activation makes it possible to solder stainless steel.
- Contains organic amine activated rosin to meet JIS standard.



■Superiot RMA / For use on precision PCB of copper and its alloy

| Item No. | Tin/Lead Ratio, Melting point | Flux(Wt%) | Soluble resistance Ω · cm | Insulation resistance Ω | Wire diam. (mm) | Wire length. (m) |
|----------|-------------------------------|--------------------------|---------------------------|-------------------------------------------------------------------------------------|-----------------|------------------|
| SWS-06 | Sn60/Pb40 183~190°C | 1.7% Noncleaning flux | 1 × 10 ⁵ | 3 × 10 ¹³ (Normal temp.) 5 × 10 ¹² (Higher humidity) | 0.6 | 5.6 |
| SWS-08 | | | | | 0.8 | 4.4 |
| SWS-10 | | | | | 1.0 | 5.5 |
| SWS-12 | | | | | 1.2 | 4.6 |

■Superiot RA / For use on stainless steel & nickel

| Item No. | Tin/Lead Ratio, Melting point | Flux(Wt%) | Soluble resistance Ω · cm | Insulation resistance Ω | Wire diam. (mm) | Wire length. (m) |
|----------|-------------------------------|--------------------------|---------------------------|-------------------------------------------------------------------------------------|-----------------|------------------|
| SWA-06 | Sn60/Pb40 183~190°C | 2.7% Noncleaning flux | 6 × 10 ⁴ | 2 × 10 ¹³ (Normal temp.) 2 × 10 ¹² (Higher humidity) | 0.6 | 5.6 |
| SWA-08 | | | | | 0.8 | 4.4 |
| SWA-10 | | | | | 1.0 | 5.5 |
| SWA-12 | | | | | 1.2 | 4.6 |

SWS-56~82 SUPERIOT RMA SOLDER



| Item No. | Wire diam. (mm) | Weight (g) |
|----------|-----------------|------------|
| SWS-56 | 0.6 | 500 |
| SWS-58 | 0.8 | |
| SWS-60 | 1.0 | |
| SWS-62 | 1.2 | 1000 |
| SWS-76 | 0.6 | |
| SWS-78 | 0.8 | |
| SWS-80 | 1.0 | |
| SWS-82 | 1.2 | |

SWA-56~82 SUPERIOT RA SOLDER



| Item No. | Wire diam. (mm) | Weight (g) |
|----------|-----------------|------------|
| SWA-56 | 0.6 | 500 |
| SWA-58 | 0.8 | |
| SWA-60 | 1.0 | |
| SWA-62 | 1.2 | 1000 |
| SWA-76 | 0.6 | |
| SWA-78 | 0.8 | |
| SWA-80 | 1.0 | |
| SWA-82 | 1.2 | |

SWU-02~06

SOLDER WICK

- SODER-WICK® Highest copper braid features fast absorption of solder.
- No cleaning process required and leaving less residue of flux on circuit board



For desoldering highly dense SMD

SWU-02 1.5mm×1.5m



For desoldering small electronic parts or plated through hole

SWU-03 1.9mm×1.5m



For desoldering medium electronic parts or solder bridges

SWU-04 2.8mm×1.5m



For desoldering large-sized parts or terminals

SWU-05 3.9mm×1.5m



For use at large solder lugs

SWU-06 5.6mm×1.5m

SW-11~53

SOLDER

- High quality solder wire for precision electronic components.
- No paste is necessary because of activated rosin.



| Item No. | diam.(mm) | Weight(g) |
|----------|-----------|-----------|
| SW-11 | 0.6 | 150 |
| SW-12 | | 500 |
| SW-13 | | 1000 |
| SW-21 | 0.8 | 150 |
| SW-22 | | 500 |
| SW-23 | | 1000 |
| SW-30 | 1.0 | 20 |
| SW-31 | | 150 |
| SW-32 | | 500 |
| SW-33 | | 1000 |
| SW-41 | 1.2 | 150 |
| SW-42 | | 500 |
| SW-43 | | 1000 |
| SW-51 | 1.6 | 150 |
| SW-52 | | 500 |
| SW-53 | | 1000 |

SD-10

DIGITAL MULTIMETER

Multifunctional and compact : The ultimate tool for all your measurements!

- 3999 Counts, Auto-ranging
- Magnetic attachment to a metallic surface
- Gold-plated test leads for corrosion-resistance

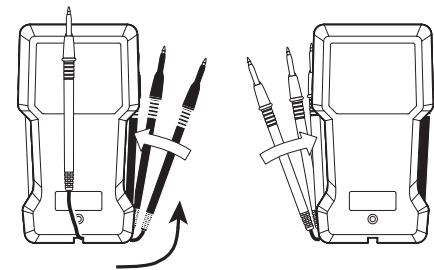

Test leads can be stored conveniently.



| | |
|-----------------------|------------------------------------------------------------|
| Operating principle | Dual integration |
| Display | LCD, 3999 Counts |
| Range switch | Auto range |
| Auto power off | Approx. 30 minutes (can be disabled) |
| Sampling | 3 times / sec. |
| Operating temperature | 0°C to 40°C less than 80% RH (without condensation) |
| Storage temperature | -10°C to 60°C less than 70% RH (without condensation) |
| Power | CR2032(3V) lithium battery x 1 |
| Battery life | Approx. 120 hours |
| Dimensions and weight | 70(W) x 127(H) x 12.5(D)mm Approx. 101g (incl. battery) |
| Lead length | Approx. 70cm |
| Standard | IEC61010-1 CAT II 600V, CAT III 300V |
| Accessories | Operation manual, Soft case |

| Function | Range | Resolution | Accuracy |
|-------------|--------|------------|--------------|
| DCV | 4V | 0.001V | ±(1.0%+3dgt) |
| | 40V | 0.01V | |
| | 400V | 0.1V | |
| | 600V | 1V | |
| ACV | 4V | 0.001V | ±(2.0%+5dgt) |
| | 40V | 0.01V | |
| | 400V | 0.1V | |
| | 600V | 1V | |
| Resistance | 400Ω | 0.1Ω | ±(2.0%+5dgt) |
| | 4kΩ | 0.001kΩ | |
| | 40kΩ | 0.01kΩ | |
| | 400kΩ | 0.1kΩ | |
| | 4MΩ | 0.001MΩ | |
| Frequency | 40MΩ | 0.01MΩ | ±(0.5%+5dgt) |
| | 5Hz | 0.001Hz | |
| | 50Hz | 0.01Hz | |
| | 500Hz | 0.1Hz | |
| | 5kHz | 0.001kHz | |
| | 50kHz | 0.01kHz | |
| Capacitance | 100kHz | 0.1kHz | ±(5.0%+5dgt) |
| | 50nF | 0.01nF | |
| | 500nF | 0.1nF | |
| | 5uF | 0.001uF | |
| | 50uF | 0.01uF | |
| | 100uF | 0.1uF | |

※Accuracy assurance of ACV·Frequency is limited to sine wave.

SCREW REMOVAL

SCISSORS

NIPPERS

PLIERS

CRIMPING STRIPPING

TWEEZERS

SCREW DRIVERS

SPECIAL DRIVERS

WRENCHES

CUTTING PROCESSING

SETS CASES

SOLDERING EQUIPMENT

ESD CHEMICALS

SL-50~53

POCKET LOUPE

- SL-50**
 ● 10x/20mm diam.
 ● 83mm length
 ● 50mm (case)



- SL-51**
 ● 8x/25mm dia.&
 15x/13mm dia.
 ● 150mm length
 ● 84mm (case)



- SL-52**
 ● Combination of 3x, 4x & 5x lens for max. 10x magnification
 ● 19mm diam. lens
 ● 83mm length
 ● 50mm (case)



- SL-53**
 ● Sharp and very distinct images with no color distortion
 ● Ideal for jewelry appraisal
 ● 18x/17mm diam.
 ● 63mm length
 ● 40mm (case)



SL-55~57

INSPECTION LOUPE

- Focus adjustment by sliding lens sleeve
- Built-in scale (detachable)

SL-55



- 10x
- 10mm diam. view
- Scale L

SL-56



- 15x
- 6mm diam. view
- Scale S

SL-57



- 22x
- 4mm diam. view
- Scale S

SL-12



- x10 Glass Lens
- Lens diameter : 30mm
- Crosshairs 0.1mm x 240
- Ext. Size : dia.38 x 50(H)
- with carrying pouch



BUILT-IN SCALE

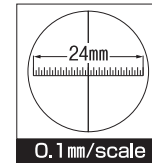
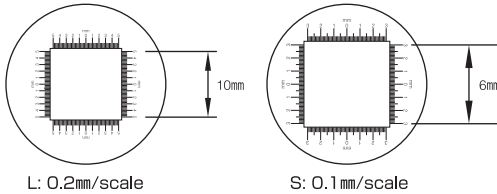

| Item No. | SL-50 | SL-51 | SL-52 | SL-53 | SL-12 | SL-55 | SL-56 | SL-57 |
|----------------|-------|----------|-------------|-------------|-------------|-------------|-------------|-------------|
| Magnification | x10 | x8 & x15 | x3, 4 & 5 | x18 | x10 | x10 | x15 | x22 |
| Lens Material | Glass | Glass | White Glass | White Glass | White Glass | White Glass | White Glass | White Glass |
| Lens Structure | 1+1 | 1+1 | single | 5-fold | 1+1 | 1+1 | 1+1 | 1+1 |

※ 1+1 Structure : 1 pce. of eyepiece and 1 pce. of objective lens
 ※ 1+2 Structure : Achromatic Lens - combination of different refractive lens minimizes chromatic aberration.
 ※ 5-fold lens : superior to achromatic lens in aspect of no aberration and creates clearer image.

SL-64

FOLDABLE MAGNIFIER

- x 3.5 Magnification acrylic lens
- Lens diameter: 40mm
- Foldable arm, flexible design
- Magnet attachment
- with carrying case



Portable magnifier



Attachment to a crimp tool

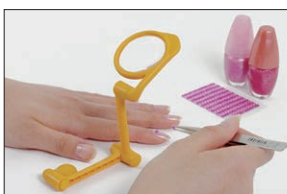

Self-standing for handsfree



Collapsible to fit carrying case

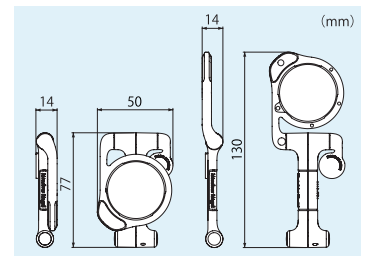

SL-01~03·11

iRoHS INSPECTION MIRROR

SL-01

- 35mm diam. angle-adjustable mirror
- O.A. length: 245mm



SL-02

- 35mm diam. adjustable all-angle ball joint mirror with pocket clip
- Telescopic rod extends from 192 to 540mm in length



SL-11

- Anti-magnetic stainless steel (AISI304) frame ideal for work on electronic parts and devices
- 21mm diam. adjustable all-angle ball joint magnifying mirror
- 2-sectioned telescopic rod (Min. 150mm - Max. 215mm)
- Compact body and thin head (frame) for inspection even at a narrow space

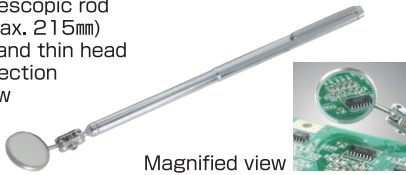

Magnified view

SL-03

- 35mm diam. adjustable all-angle ball joint magnifying mirror (Concave)
- Telescopic rod extends from 265 to 740mm in length



with built-in magnet

SL-04·07

iRoHS DESK-TOP LOUPE

SL-07

- x 2.5 ϕ 90mm lens
- 175mm Flexible shaft allows easy positioning.



SL-04

- Magnifying power: 2.5x/75mm diam. lens.
- Ball joint permits free change of angles and positions.



SL-22

LED LIGHT LOUPE

- 2x/95mm diam. Acrylic lens with x4 bifocal lens built-in
- Long-life and bright LED (16 bulbs)
- DC power (AA battery x 4 pcs.)
※ Battery is not included.
- AC adapter (Input voltage 100-240V) included
- Magnet base stand for handsfree work
- 310mm Flexible arm for easy positioning
- Desk clamp (Max. opening 65mm. Depth 58mm)



LED (16bulbs)

 ϕ 25mm (x4) ϕ 95mm (x2)

Flexible arm

Magnet base

SL-23

iRoHS LED STAND LOUPE



Built-in LED

 ϕ 22mm (x5) ϕ 105mm (x2)

Flexible arm

- 2x/105mm diam. Acrylic lens with x5 bifocal lens built-in
- Illuminated by 2 LED's, ideal for inspection and hobby use
- DC power (AA battery x 3 pcs.)
※ Battery is not included.
- 300mm Flexible arm for easy positioning

SL-71

FLASHLIGHT LOUPE

- Light beam illuminates magnified area.
- 10X, 30mm diam.
- 2 x C-cell battery adapted
- O.A. length: 177mm



Built-in 20mm scale

SL-72

iRoHS UTILITY LOUPE

- 3X 65mm diam. lens consists of aberration-free white lens.
- Versatile use with chrome-plated frame and wooden shaft.
- O.A. length: 175mm



SL-80~83/85~88

iRoHS HEAD LOUPE

- Suitable for inspection/repair of electronic and precise instruments
- Well-fitted head band with velcro tape
- Usable even while wearing glasses.

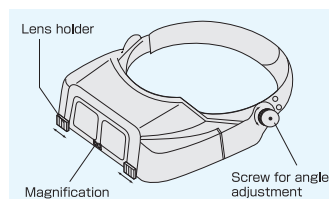

Lens holder

Magnification

Screw for angle adjustment



Head loupe

| Item No. | Magnification |
|----------|---------------|
| SL-80 | 1.8 |
| SL-81 | 2.3 |
| SL-82 | 2.7 |
| SL-83 | 3.5 |

Replacement lens

| Item No. | Magnification |
|----------|---------------|
| SL-85 | 1.8 |
| SL-86 | 2.3 |
| SL-87 | 2.7 |
| SL-88 | 3.5 |

● The size of all the replacement lens is common and suitable for any head loupes.

SCREW REMOVAL

SCISSORS

NIPPERS

PLIERS

CRIMPING STRIPPING

TWEEZERS

SCREW DRIVERS

SPECIAL DRIVERS

WRENCHES

CUTTING PROCESSING

SETS CASES

SOLDERING EQUIPMENT

ESD CHEMICALS

ESD Products and Chemicals



ZC-01·02

RoHS CONDUCTIVE FOAM

- Conductive urethane foam with high density in 10mm thickness.
- Protects CMOS IC and other static-sensitive components during storage, in transit and in hand.
- Material: Polyethylene

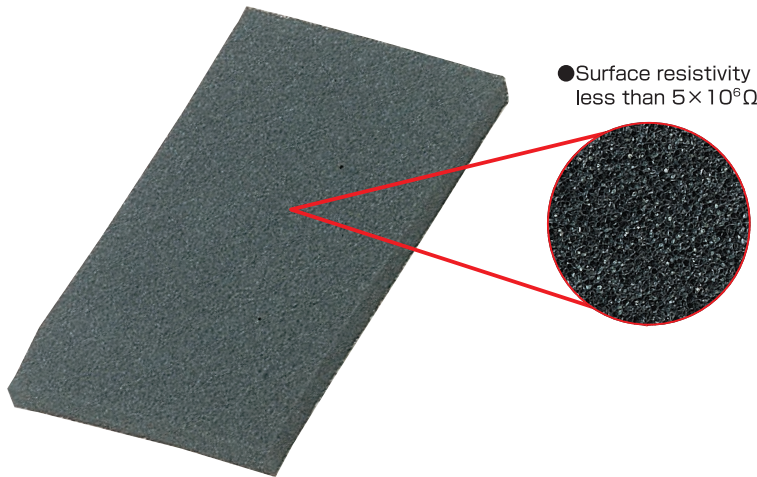

● Surface resistivity less than $5 \times 10^9 \Omega$

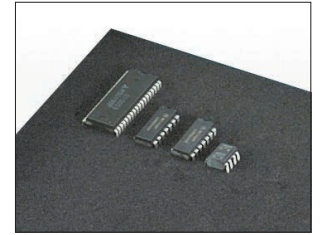

| Item No. | Size(mm) |
|----------|------------|
| ZC-01 | 075×130×10 |
| ZC-02 | 100×290×10 |

ZC-50

RoHS WRIST STRAP

- Conveniently-designed earth cord to improve precise work efficiently
- Curving-shaped & wide plastic body (30x20mm) featuring higher conductivity around wrist
- Silver filaments in elastic band ideal for high conductivity & anti-metallic allergy



Applications

Assembly or repair of electronics and precise instrument for anti-static electricity

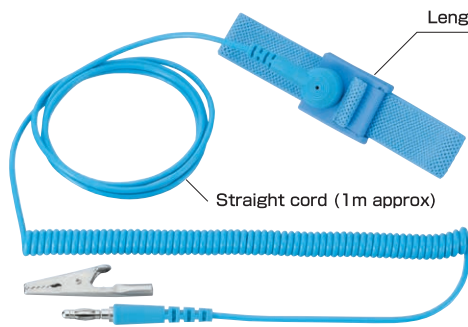

Length adjustable

Straight cord (1m approx)

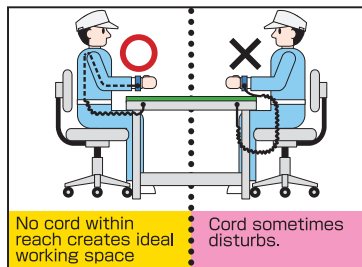

No cord within reach creates ideal working space

Cord sometimes disturbs.



Specifications :

- Adjustable type wrist band
- Built-in 1MΩ resistor for safety
- Alligator clip included
- Polyester elastic band woven with silver filaments

If anyone who is charged with static electricity through clothes touches IC's and electronic components, he discharges electricity through his fingers and gives a damage to IC's and electronic components. Wrist Strap can eliminate static electricity through his wrist to prevent them from being damaged.

ZC-80

RoHS ANTI-STATIC SERVICE KIT

- Mat size : 900×600mm (Thickness 0.7mm)
- Contents : Wrist strap with cord (1MΩ)
Spare earth cord (1MΩ)
Zippered carrying case (270×200mm)

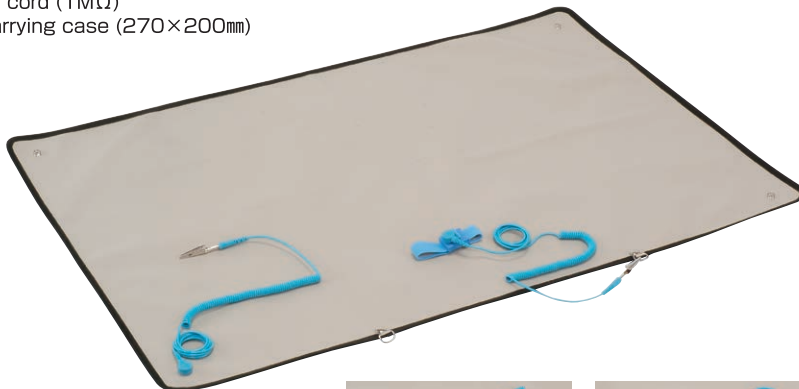

Rayon backing with stud

| Layer | Color | Material | Thickness | Surface Resistivity |
|--------|-------|----------|-----------|--------------------------|
| Top | Beige | PVC | 0.35mm | $7.3 \times 10^9 \Omega$ |
| Bottom | Gray | Rayon | 0.3mm | $1.5 \times 10^9 \Omega$ |



Earth cord

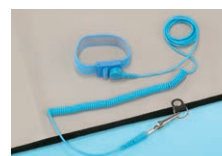

Wrist strap



SCREW REMOVAL

SCISSORS

NIPPERS

PLIERS

CRIMPING STRIPPING

TWEEZERS

SCREW DRIVERS

SPECIAL DRIVERS

WRENCHES

CUTTING PROCESSING

SETS CASES

SOLDERING EQUIPMENT

ESD CHEMICALS

ZC-44~49  **STATIC CONDUCTIVE GLOVES**

- Surface resistivity : $10^5 \sim 10^6 \Omega$ sq.(Finger) $10^7 \Omega$ sq.(Palm)
- Ideal for clean room, assembly of electronic devices, handling of plastic products, etc.
- Copper sulfide mixed with acryl/nylon creates an excellent conductive effect (Finger Part)
- Seamless and dust-free mono-filament
- Chemical dyeing of conductive element features less reduction of conductivity withstanding repeated washing
- Material : Fabric - Nylon 90% Acryl 10%
: Coating - Polyurethane Resin



ZC-51~56  **ANTI-STATIC GLOVES**

- Surface resistivity : $10^6 \sim 10^9 \Omega$ sq.
- Ideal for any work in the facility where anti-static should be controlled
- Seamless and dust-free mono-filament
- Washable with ordinary detergent
- Material : Fabric - Nylon 75% Acryl 25%
: Coating - Polyurethane Resin



■Fingertip Coating (mm)

| Item No. | Size | A×B |
|----------|------|--------|
| ZC-44 | S | 72×185 |
| ZC-45 | M | 83×190 |
| ZC-46 | L | 85×200 |

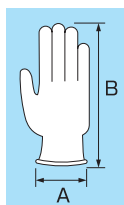

■Palm Coating (mm)

| Item No. | Size | A×B |
|----------|------|--------|
| ZC-47 | S | 80×210 |
| ZC-48 | M | 85×220 |
| ZC-49 | L | 90×230 |

■Fingertip Coating (mm)

| Item No. | Size | A×B |
|----------|------|--------|
| ZC-51 | S | 75×190 |
| ZC-52 | M | 88×200 |
| ZC-53 | L | 89×215 |

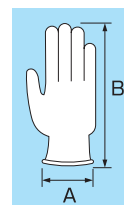

■Palm Coating (mm)

| Item No. | Size | A×B |
|----------|------|--------|
| ZC-54 | S | 77×210 |
| ZC-55 | M | 90×220 |
| ZC-56 | L | 95×230 |

ZC-38~43  **DUST-FREE GLOVES**

- Flexible & comfortable gloves made of elastic and breathable nylon fiber
- Ideal for use in clean room and handling of C.R.T., electric bulb, compact disc, glass, etc.
- Seamless and dust-free mono-filament
- Non-slip coating for accurate assembly work
- Washable with ordinary detergent
- Material : Fabric - Wooly Nylon
: Coating - Polyurethane Resin

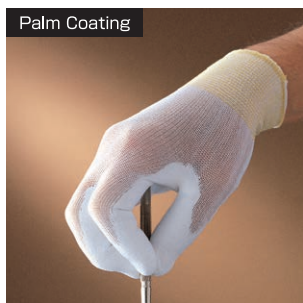
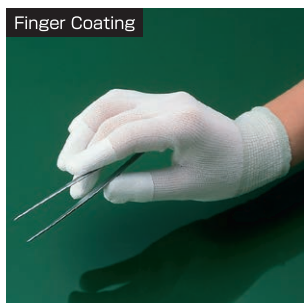

■Fingertip Coating (mm)

| Item No. | Size | A×B |
|----------|------|--------|
| ZC-38 | S | 77×185 |
| ZC-39 | M | 90×190 |
| ZC-40 | L | 90×200 |

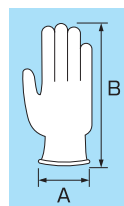

■Palm Coating (mm)

| Item No. | Size | A×B |
|----------|------|--------|
| ZC-41 | S | 80×210 |
| ZC-42 | M | 90×220 |
| ZC-43 | L | 95×230 |

ZC-82·84·86  **STATIC CONDUCTIVE BAG**

- Surface resistivity : $10^4 \Omega$ or less
- Color : Black
- Thickness : 0.05mm
- Material : Polyethylene (Carbon contained)



| Item No. | Size(mm) | Package |
|----------|----------|---------|
| ZC-82 | 100×150 | 100pcs. |
| ZC-84 | 200×300 | 100pcs. |
| ZC-86 | 300×450 | 100pcs. |

ZC-92·94·96  **ANTI-STATIC BAG**

- Surface resistivity : $10^{11} \Omega$ or less
- Color : Blue Transparent
- Thickness : 0.05mm
- Material : Polyethylene

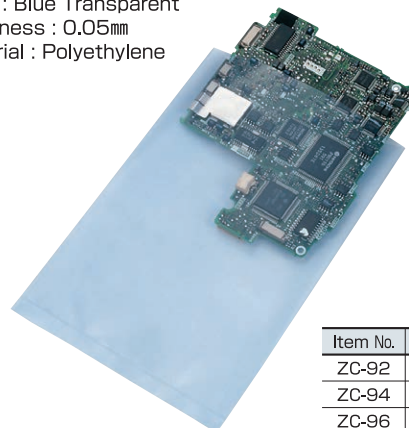

| Item No. | Size(mm) | Package |
|----------|----------|---------|
| ZC-92 | 100×150 | 100pcs. |
| ZC-94 | 200×300 | 100pcs. |
| ZC-96 | 300×450 | 100pcs. |

ZCM-01~04**RoHS CONDUCTIVE COLORED MAT**

- Static-Dissipative mat maintains an ESD-Safe working surface.
- Anti-Fatigue rubber material that provides cushioning comfort.
- Available in pre-cut mats or rolls.

**Usage**

Put ZC-62 on the reverse of the mat for grounding.
Use ZC-63 in connection of mat.

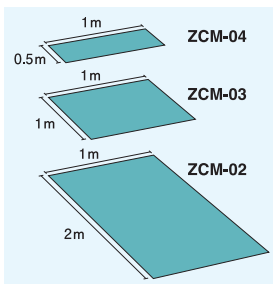
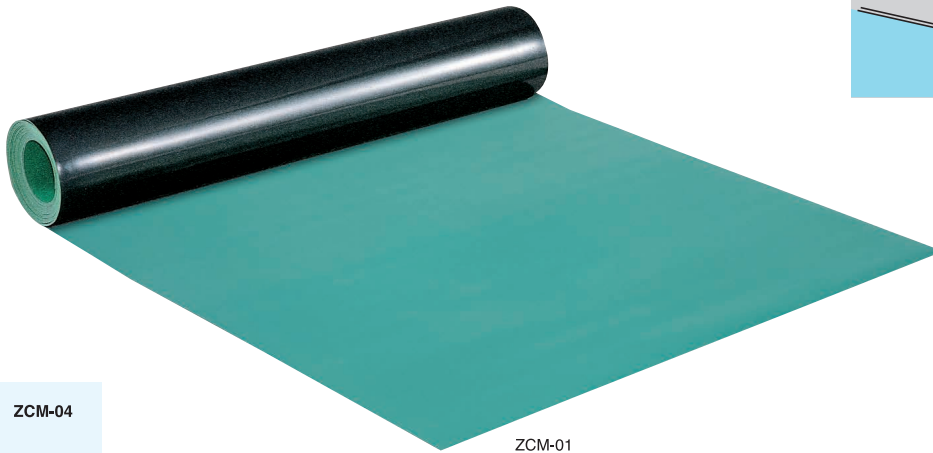
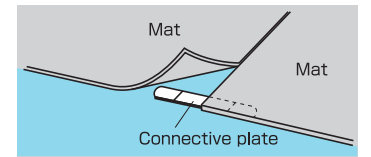

- Surface resistivity
Top Layer (Green) : $10^8 \sim 10^{10} \Omega$
Bottom Layer (Black) : $10^3 \sim 10^5 \Omega$

| Item No. | Size |
|----------|-------------|
| ZCM-01 | 1m×10m×2mm |
| ZCM-02 | 1m×2m×2mm |
| ZCM-03 | 1m×1m×2mm |
| ZCM-04 | 1m×0.5m×2mm |

ZC-62**RoHS GROUND CORD**

- For ZCM-01~04
- Size : Cord.....2m Plate...15cm×2cm

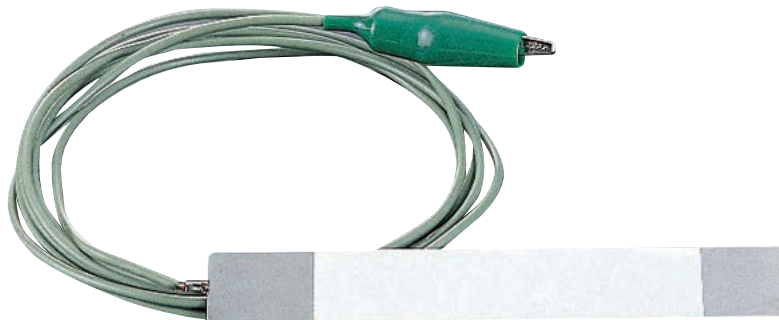
**ZC-63****RoHS CONNECTIVE PLATE**

- For ZCM-01~04
- Contents : 10pcs.
- Size : 15cm×2cm

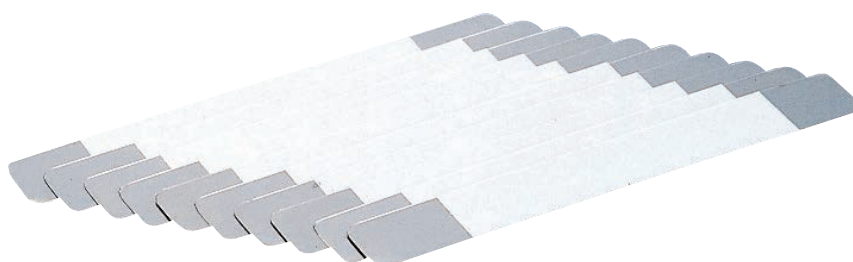
SCREW
REMOVAL

SCISSORS

NIPPERS

PLIERS

CRIMPING
STRIPPING

TWEEZERS

SCREW
DRIVERSSPECIAL
DRIVERS

WRENCHES

CUTTING
PROCESSINGSETS
CASESSOLDERING
EQUIPMENTESD
CHEMICALS

ZC-28

RUST REMOVER

Amazing - How quickly it cleans rust off!

- Since it is a neutral liquid, you can work safely (it does not contain acid or alkali).
- Rust on small components, such as rusted screws, can be removed in seconds.
- No need to scrub.

How it works on rusty screws

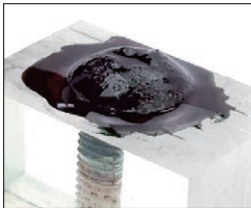

1. Penetration

The liquid penetrates through small gaps and reaches the screw's thread in seconds!



2. Rapid Action

It instantly reacts on the rust and turns purple!



3. Screw Removal

Utilize Screw Removal Pliers to loosen the treated screw with sure-gripping jaws.



SAFE: Neutral liquid
Less harmful to bare skin
(unlike acid or alkali)



Before



After

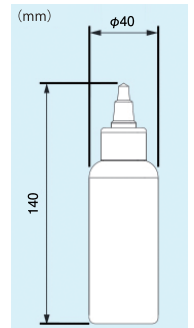

PRODUCT VIDEO



Before
After

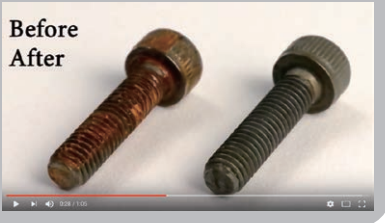

| Item No. | pH | Capacity | Bottle size |
|----------|---------|----------|--------------|
| ZC-28 | Neutral | 100ml | φ40 x H140mm |

ZC-19

ROHS OILER

- Compact-sized and handy oiler
- Nozzle extendable (60mm-long approx.) for oiling at hard-to-reach area
- Capacity: 20ml
- Material: PE (Bottle/Cap), Brass (Nozzle)
- Usage: Oil, Water, Cleaning fluid, etc.

How to use

- ① Extend nozzle upward.
 - ② Unscrew plastic cap.
 - ③ Remove packing inside.
 - ④ Pour oil in bottle.
 - ⑤ Fasten the packing and the cap with nozzle in order.
- ※ Keep the bottle upright in storage.



Machinery maintenance



Lubrication

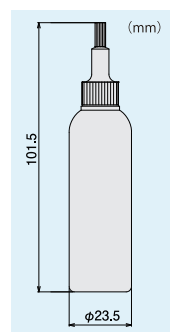

D

| ITEM No. | CODE No. | ITEM | PAGE |
|----------|----------|---------------------------------------|------|
| DA-01 | 1001 | Alignment Screwdriver | 49 |
| DA-02 | 1002 | Alignment Screwdriver | 49 |
| DA-03 | Discon. | Alignment Screwdriver | 49 |
| DA-40 | 1040 | Alignment Screwdriver | 49 |
| DA-48 | 1048 | Ceramic Alignment Screwdriver | 48 |
| DA-50 | 1050 | Ceramic Alignment Screwdriver | 48 |
| DA-51 | 1051 | Ceramic Alignment Screwdriver | 48 |
| DA-52 | 1052 | Ceramic Alignment Screwdriver | 48 |
| DA-53 | 1053 | Ceramic Alignment Screwdriver | 48 |
| DA-54 | 1054 | Ceramic Alignment Screwdriver | 48 |
| DA-55 | 1055 | Ceramic Alignment Screwdriver | 48 |
| DA-56 | 1056 | Ceramic Alignment Screwdriver | 48 |
| DA-57 | 1057 | Ceramic Alignment Screwdriver | 48 |
| DA-58 | 1058 | Ceramic Alignment Screwdriver | 48 |
| DA-59 | 1059 | Ceramic Alignment Screwdriver | 48 |
| DA-72 | 1072 | Ceramic Alignment Screwdriver | 48 |
| DA-73 | 1073 | Ceramic Alignment Screwdriver | 48 |
| DA-74 | 1074 | Ceramic Alignment Screwdriver | 48 |
| DA-75 | 1075 | Ceramic Alignment Screwdriver | 48 |
| DA-76 | 1076 | Ceramic Alignment Screwdriver | 48 |
| DA-77 | 1077 | Ceramic Alignment Screwdriver | 48 |
| DA-78 | 1078 | Ceramic Alignment Screwdriver | 48 |
| DA-79 | 1079 | Ceramic Alignment Screwdriver | 48 |
| DA-81 | 1081 | Ceramic Alignment Screwdriver | 49 |
| DA-82 | 1082 | Ceramic Alignment Screwdriver | 49 |
| DA-83 | 1083 | Ceramic Alignment Screwdriver | 49 |
| DA-84 | 1084 | Ceramic Alignment Screwdriver | 49 |
| DA-85 | 1085 | Ceramic Alignment Screwdriver | 49 |
| DA-86 | 1086 | Ceramic Alignment Screwdriver | 49 |
| DA-87 | 1087 | Ceramic Alignment Screwdriver | 49 |
| DA-88 | 1088 | Ceramic Alignment Screwdriver | 49 |
| DAP-01 | 0601 | Pentalobe Driver | 43 |
| DAT-02 | 0602 | Hex-Lobe Driver | 43 |
| DB-15 | 1315 | Ball Point Driver | 45 |
| DB-20 | 1320 | Ball Point Driver | 45 |
| DB-25 | 1325 | Ball Point Driver | 45 |
| DB-30 | 1330 | Ball Point Driver | 45 |
| DB-40 | 1340 | Ball Point Driver | 45 |
| DB-50 | Discon. | Ball Point Driver | 45 |
| DBZ-50B | 1448 | Handle Grip for DBZ | 8 |
| DBZ-51 | 1451 | Replacement Bit for DBZ-60G | 9 |
| DBZ-52 | 1452 | Replacement Bit for DBZ-60G | 9 |
| DBZ-53 | 1453 | Optional Bit for DBZ-60G | 9 |
| DBZ-54 | 1465 | Optional Bit for DBZ-60G | 9 |
| DBZ-56 | 1466 | Optional Bit for DBZ-60G | 9 |
| DBZ-57 | 1467 | Optional Bit for DBZ-60G | 9 |
| DBZ-60G | 1462 | Rapid Screw Extractor | 8 |
| DBZ-62 | 1471 | Optional Bit for DBZ-60G | 9 |
| DBZ-63 | 1472 | Optional Bit for DBZ-60G | 9 |
| DBZ-64 | 1473 | Optional Bit for DBZ-60G | 9 |
| DBZ-65 | 1474 | Optional Bit for DBZ-60G | 9 |
| DG-01 | 1101 | Pro Grip Driver | 38 |
| DG-02 | 1102 | Pro Grip Driver | 38 |
| DG-03 | 1103 | Pro Grip Driver | 38 |
| DG-04 | 1104 | Pro Grip Driver | 38 |
| DG-05 | 1105 | Cushion Driver | 38 |
| DG-08 | 1108 | Master Grip Driver | 38 |
| DG-09 | 1109 | Master Grip Driver | 38 |
| DG-11 | 1111 | Extra Long Grip Driver | 38 |
| DG-12 | 1112 | Extra Long Grip Driver | 38 |
| DG-13 | 1113 | Extra Long Grip Driver | 38 |
| DG-14 | 1114 | Extra Long Grip Driver | 38 |
| DG-21 | 1121 | Mini Soft Driver | 39 |
| DG-22 | 1122 | Mini Soft Driver | 39 |
| DG-23 | 1123 | Mini Soft Driver | 39 |
| DG-24 | 1124 | Mini Soft Driver | 39 |
| DH-15 | 1515 | Hex Driver | 45 |
| DH-20 | 1520 | Hex Driver | 45 |
| DH-25 | 1525 | Hex Driver | 45 |
| DH-30 | 1530 | Hex Driver | 45 |
| DH-40 | 1540 | Hex Driver | 45 |
| DH-50 | 1550 | Hex Driver | 45 |
| DH-60 | Discon. | Hex Driver | 45 |
| DJ-01 | Discon. | Plug Jack Driver | 44 |
| DJ-02 | Discon. | Plug Jack Driver | 44 |
| DJ-03 | 1763 | Plug Jack Driver | 44 |
| DJ-04 | 1764 | Plug Jack Driver | 44 |
| DJ-05 | Discon. | Plug Jack Driver | 44 |
| DK-01 | 1601 | Hex Driver Set | 46 |
| DK-02 | 1602 | Hex Driver Set | 46 |
| DK-03 | 1603 | Ball Point Driver Set | 46 |
| DK-04 | 1604 | Nut Driver Set | 46 |
| DK-05 | 1605 | Interchangeable Driver Set | 47 |
| DK-05P | | Interchangeable Driver Set | 47 |
| DK-06 | 1606 | Interchangeable Driver Set | 47 |
| DK-06P | | Interchangeable Driver Set | 47 |
| DK-07 | Discon. | Interchangeable Driver Set | 47 |
| DK-08 | 1608 | Interchangeable Driver Set | 47 |
| DK-10 | Discon. | ⊕⊖Precision Driver Set | 47 |
| DK-13 | 1613 | Reversible Precision Dr. Set | 45 |
| DK-14 | 1614 | Nut Driver Set | 46 |
| DK-16 | 1616 | Mini Soft Driver Set | 39 |
| DK-20 | Discon. | ⊕Precision Driver Set | 47 |
| DK-21 | Discon. | Precision Driver | 47 |
| DK-22 | Discon. | Precision Driver | 47 |
| DK-23 | Discon. | Precision Driver | 47 |
| DK-24 | Discon. | Precision Driver | 47 |
| DK-25 | Discon. | Precision Driver | 47 |
| DK-26 | Discon. | Precision Driver | 47 |
| DK-30 | Discon. | ⊖Precision Driver Set | 47 |
| DK-31 | Discon. | Precision Driver | 47 |
| DK-32 | Discon. | Precision Driver | 47 |
| DK-33 | Discon. | Precision Driver | 47 |
| DK-34 | Discon. | Precision Driver | 47 |
| DK-35 | Discon. | Precision Driver | 47 |
| DK-36 | Discon. | Precision Driver | 47 |
| DK-50 | 1650 | Reversible Driver Set | 39 |
| DK-51 | 1651 | Reversible Driver | 39 |
| DK-52 | 1652 | Reversible Driver | 39 |
| DK-53 | 1653 | Reversible Driver | 39 |
| DK-60 | Discon. | ⊕⊖Precision Driver Set | 47 |
| DK-80 | Discon. | Computer Driver Set | 47 |
| DK-81 | Discon. | Mobile Phone Driver Set | 47 |
| DK-82 | Discon. | Mobile Phone Driver Set | 47 |
| DK-90 | 1690 | Ceramic Alignment Driver Set | 48 |
| DK-91 | 1691 | Ceramic Alignment Driver Set | 49 |
| DKD-01 | 1781 | Circuit Testing Driver | 45 |
| DKD-02 | Discon. | Circuit Testing Driver | 45 |
| DKD-03 | 1783 | Led Circuit Tester | 45 |
| DM-20 | 1180 | ⊕Precision Driver Set | 47 |
| DM-21 | 1181 | ⊕Precision Driver | 47 |
| DM-22 | 1182 | ⊕Precision Driver | 47 |
| DM-23 | 1183 | ⊕Precision Driver | 47 |
| DM-24 | 1184 | ⊕Precision Driver | 47 |
| DM-25 | 1185 | ⊕Precision Driver | 47 |
| DM-26 | 1186 | ⊕Precision Driver | 47 |
| DM-30 | 1190 | ⊖Precision Driver Set | 47 |
| DM-31 | 1191 | ⊖Precision Driver | 47 |
| DM-32 | 1192 | ⊖Precision Driver | 47 |
| DM-33 | 1193 | ⊖Precision Driver | 47 |
| DM-34 | 1194 | ⊖Precision Driver | 47 |
| DM-35 | 1195 | ⊖Precision Driver | 47 |
| DM-36 | 1196 | ⊖Precision Driver | 47 |
| DM-60 | 1200 | ⊕⊖Precision Driver Set | 47 |
| DN-01 | 1701 | Nut Driver | 44 |
| DN-02 | 1702 | Nut Driver | 44 |
| DN-03 | 1703 | Nut Driver | 44 |
| DN-04 | 1704 | Nut Driver | 44 |
| DN-05 | 1705 | Nut Driver | 44 |
| DN-06 | 1706 | Nut Driver | 44 |
| DN-07 | 1707 | Nut Driver | 44 |
| DN-08 | 1708 | Nut Driver | 44 |
| DN-09 | 1709 | Nut Driver | 44 |
| DN-10 | 1710 | Nut Driver | 44 |
| DN-12 | 1712 | Nut Driver | 44 |
| DNC-55T | 0455 | Nut Catching Driver | 44 |
| DNC-57T | 0470 | Nut Catching Driver | 44 |
| DNC-65T | 0465 | Nut Catching Driver | 44 |
| DNP-05 | Discon. | Pro Nut Driver | 44 |
| DNP-07 | Discon. | Pro Nut Driver | 44 |
| DNP-08 | Discon. | Pro Nut Driver | 44 |
| DNP-10 | Discon. | Pro Nut Driver | 44 |
| DP-03 | 1803 | Pro-Use Driver⊕ | 38 |
| DP-13 | 1813 | Pro-Use Driver⊖ | 38 |
| DP-24 | 1824 | Pro-Use Driver⊕ | 38 |
| DP-34 | 1834 | Pro-Use Driver⊕ | 38 |
| DP-44 | 1844 | Pro-Use Driver⊖ | 38 |
| DP-54 | 1854 | Pro-Use Driver⊖ | 38 |
| DP-64 | 1864 | Pro-Use Driver⊕ | 38 |
| DR-03 | 1203 | Ratchet Stubby Driver | 40 |
| DR-04 | 1204 | Ratchet Stubby Driver Set | 40 |
| DR-05 | 1205 | Offset Ratchet Driver | 40 |
| DR-06 | 1206 | Offset Ratchet Driver with Bit Set | 40 |
| DR-07 | 1207 | Twin Wrench Driver Set | 40 |
| DR-08 | 1208 | Ratchet Stubby Driver Set(Flex.) | 40 |
| DR-10 | 1210 | Bit Set | 41 |
| DR-11 | 1211 | Bit Set | 41 |
| DR-14 | Discon. | Bit Set | 41 |
| DR-15 | 1215 | Bit Set | 41 |
| DR-16 | 1216 | Bit Set | 41 |
| DR-17 | 1217 | Bit Set | 41 |
| DR-18 | 1218 | Bit Set for Mobile Phone | 43 |
| DR-50 | 1250 | Twin Wrench Driver Set | 43 |
| DR-51 | 1251 | Master Grip Driver for Hex-Lobe Screw | 44 |
| DR-52 | 1252 | Master Grip Driver | 40 |
| DR-53 | Discon. | Cushioned Grip Ratchet Driver | 40 |
| DR-54 | 1255 | Stubby Ratchet Driver | 39 |

| | | | |
|--------|---------|--------------------------------------|----|
| DR-55 | 1255 | Mini Offset Ratchet | 41 |
| DR-56 | 1256 | 7-in-1 Angled Ratchet | 41 |
| DS-03 | 1903 | Standard Driver⊕ | 38 |
| DS-12 | 1912 | Standard Driver⊖ | 38 |
| DS-13 | 1913 | Standard Driver⊖ | 38 |
| DS-14 | 1914 | Standard Driver⊖ | 38 |
| DS-16 | Discon. | Standard Driver⊖ | 38 |
| DS-23 | 1923 | Standard Driver⊕ | 38 |
| DS-24 | 1924 | Standard Driver⊕ | 38 |
| DS-33 | 1933 | Standard Driver⊖ | 38 |
| DS-34 | 1934 | Standard Driver⊖ | 38 |
| DS-44 | 1944 | Standard Driver⊕ | 38 |
| DS-46 | 1946 | Standard Driver⊕ | 38 |
| DS-54 | 1954 | Standard Driver⊖ | 38 |
| DS-64 | 1964 | Standard Driver⊕ | 38 |
| DS-76 | Discon. | Standard Driver⊖ | 38 |
| DS-85 | Discon. | Standard Driver⊕ | 38 |
| DST-01 | 1581 | Stubby Driver | 39 |
| DST-02 | 1582 | Stubby Driver | 39 |
| DST-05 | 1585 | Combination Reversible Stubby Driver | 39 |
| DST-06 | 1586 | Miniature Reversible Driver | 39 |
| DST-07 | 1587 | Miniature Reversible Driver | 39 |
| DT-02 | 0502 | Mobile Phone Driver | 43 |
| DT-04 | 0504 | Mobile Phone Driver | 43 |
| DT-05 | 0505 | Mobile Phone Driver | 43 |
| DT-06 | 0506 | Mobile Phone Driver | 43 |
| DT-08 | 0548 | Mobile Phone Driver | 43 |
| DT-10 | 0510 | Mobile Phone Driver | 43 |
| DT-15 | 0515 | Mobile Phone Driver | 43 |
| DT-20 | 0520 | Mobile Phone Driver | 43 |
| DTC-20 | 0570 | Mobile Phone Driver | 43 |
| DTC-27 | 0577 | Mobile Phone Driver | 43 |
| DTH-03 | Discon. | Mobile Phone Driver | 43 |
| DTP-03 | 0543 | Pentalobe Driver | 43 |
| DTP-05 | 0545 | Pentalobe Driver | 43 |
| DTX-04 | 0544 | Mobile Phone Driver | 43 |
| DTX-08 | 0508 | Mobile Phone Driver | 43 |
| DTY-02 | 0582 | Mobile Phone Driver | 43 |
| DTY-03 | 0583 | Mobile Phone Driver | 43 |
| DZ-01 | 0901 | Miniature Driver | 39 |
| DZ-02 | 0902 | Miniature Driver | 39 |
| DZ-03 | Discon. | Cross Nut Driver | 43 |
| DZ-04 | Discon. | Cross Nut Driver | 43 |
| DZ-05 | Discon. | Cross Nut Driver Set | 43 |
| DZ-06 | Discon. | Offset Driver | 43 |
| DZ-07 | Discon. | Offset Driver | 43 |
| DZ-08 | Discon. | Offset Driver Set | 43 |
| DZ-11 | Discon. | Flexible Shaft Driver | 43 |
| DZ-12 | Discon. | Flexible Shaft Driver | 43 |
| DZ-21 | Discon. | Screw Holding Driver | 43 |
| DZ-23 | Discon. | Screw Holding Driver | 43 |
| DZ-24 | Discon. | Screw Holding Driver | 43 |
| DZ-25 | Discon. | Screw Holding Driver | 43 |

K

| ITEM No. | CODE No. | ITEM | PAGE |
|----------|----------|----------------------------------|------|
| KA-15 | 7115 | ABS Attache Case | 66 |
| KA-22 | 7122 | Attache Case (Wide Type) | 65 |
| KA-30 | 7130 | Aluminium Case | 67 |
| KA-42 | 7142 | Aluminium Case | 67 |
| KA-43 | 7143 | Aluminium Case | 67 |
| KA-44 | 7144 | Aluminium Case | 67 |
| KA-50 | 7150 | Aluminium Case | 66 |
| KA-51 | 7151 | Aluminium Case | 66 |
| KA-54 | 7154 | Aluminium Attache Case | 67 |
| KA-57 | 7157 | Aluminium Case | 66 |
| KA-91 | Discon. | Aluminium Case | 67 |
| KAC-30 | 7230 | Aluminium Case for Clean Room | 67 |
| KAC-42 | 7242 | Aluminium Case for Clean Room | 67 |
| KD-01 | Discon. | Panel Kits for Field Maintenance | 68 |
| KD-02 | Discon. | Panel Kits for Field Maintenance | 68 |
| KD-03 | Discon. | Panel Kits for Field Maintenance | 68 |
| KD-04 | Discon. | Panel Kits for Electronics Work | 68 |
| KD-05 | Discon. | Panel Kits for Electronics Work | 68 |
| KD-06 | Discon. | Panel Kits for Electronics Work | 68 |
| KDE-01 | Discon. | Panel | 68 |
| KDE-02 | Discon. | Panel | 68 |
| KDE-03 | Discon. | Panel | 68 |
| KDE-04 | Discon. | Panel | 68 |
| KDE-05 | Discon. | Panel | 68 |
| KDE-06 | Discon. | Panel | 68 |
| KP-01 | 7401 | Parts Box | 68 |
| KP-02 | 7402 | Parts Box | 68 |
| KP-02K | 7408 | Parts Box (Heavy-Duty Type) | 68 |
| KP-03 | 7403 | Parts Box | 68 |
| KP-03K | 7409 | Parts Box (Heavy-Duty Type) | 68 |
| KP-04 | 7404 | Miniature Box | 68 |
| KP-51 | 7451 | Ic Storage Box | 68 |

| | | | |
|--------|---------|-------------------------------|----|
| KP-52 | 7452 | Ic Storage Box | 68 |
| KP-95 | 7495 | Dividing Plate | 68 |
| KP-96 | 7496 | Dividing Plate | 68 |
| KP-97 | 7497 | Dividing Plate | 68 |
| KS-01 | 7001 | My Kit | 60 |
| KS-02 | 7002 | My Kit | 60 |
| KS-03 | 7003 | Tool Kit | 62 |
| KS-04 | 7004 | Tool Kit | 62 |
| KS-05 | 7005 | Maintenance Kit | 61 |
| KS-06 | 7006 | Maintenance Kit | 61 |
| KS-06R | Discon. | Maintenance Kit | × |
| KS-08 | 7038 | Electronics Kit | 62 |
| KS-09 | Discon. | Tool Kit | × |
| KS-10 | Discon. | Tool Kit | × |
| KS-11 | 7011 | Tool Kit | 64 |
| KS-12 | 7012 | Attache Tool Kit | 64 |
| KS-14 | 7014 | Electronics Kit | 63 |
| KS-17 | Discon. | Tool Kit | × |
| KS-18 | Discon. | Tool Kit | × |
| KS-20 | 7020 | My Kit | 60 |
| KS-27 | 7027 | My Kit | 60 |
| KS-28 | 7028 | Tool Kit | 63 |
| KS-30 | Discon. | Attache Tool Kit | × |
| KS-31 | Discon. | Attache Tool Kit | × |
| KS-34 | 7034 | Screw Emergency Tool Kit | 7 |
| KSC-04 | 7504 | Tool Kit | 62 |
| KSC-05 | 7505 | Maintenance Kit | 61 |
| KSC-06 | 7506 | Maintenance Kit | 61 |
| KSE-03 | 7053 | Tool Case | 62 |
| KSE-04 | 7054 | Tool Case | 62 |
| KSE-06 | 7056 | Tool Case | 61 |
| KSE-09 | Discon. | Tool Case with Panel | × |
| KSE-10 | Discon. | Tool Case with Panel | × |
| KSE-11 | 7061 | Tool Case with Panel | 64 |
| KSE-12 | 7062 | Attache Case with Empty Panel | 65 |
| KSE-17 | Discon. | Tool Case with Empty Panel | × |
| KSE-18 | Discon. | Tool Case with Empty Panel | × |
| KSE-28 | 7078 | Eva Tool Case with Panel | 63 |
| KSE-30 | Discon. | Attache Case with Empty Panel | × |
| KSE-31 | Discon. | Attache Case with Empty Panel | × |

N

| ITEM No. | CODE No. | ITEM | PAGE |
|----------|----------|-----------------------------|------|
| NK-15 | 3115 | Diagonal Nippers | 18 |
| NK-16 | 3116 | Diagonal Nippers | 18 |
| NK-25 | 3125 | Diagonal Nippers | 18 |
| NK-26 | 3126 | Diagonal Nippers | 18 |
| NK-36 | 3136 | Heavy Duty Diagonal Nippers | 18 |
| NN-45 | 3145 | Slant Edge Nippers | 19 |
| NN-46 | 3146 | Slant Edge Nippers | 19 |
| NN-56 | 3156 | Slant Edge Nippers | 19 |
| NP-03 | 3083 | Plastic Nippers | 19 |
| NP-04 | 3084 | Plastic Nippers | 19 |
| NP-05 | 3085 | Plastic Nippers | 19 |
| NS-03 | 3003 | Micro Nippers | 16 |
| NS-04 | 3004 | Micro Nippers | 16 |
| NS-06 | 3006 | Micro Nippers | 16 |
| NSX-04 | 3001 | Micro Nippers | 16 |
| NZ-03 | 3093 | Chip Cutter | 17 |
| NZ-05 | 3095 | Chip Cutter | 17 |
| NZ-12 | 3098 | Parallel Nippers | 17 |
| NZ-13 | 3099 | Parallel Nippers | 17 |

P

| ITEM No. | CODE No. | ITEM | PAGE |
|----------|----------|---------------------------|------|
| PA-01 | 3501 | Wire Pliers | 25 |
| PA-02 | Discon. | Wire Pliers | × |
| PA-03 | 3503 | Wire Pliers | 25 |
| PA-04 | Discon. | Wire Pliers | × |
| PA-05 | 3505 | Wire Stripper | 31 |
| PA-06 | 3506 | Wire Stripper | 31 |
| PA-07 | 3507 | Wire Stripper | 31 |
| PA-08 | Discon. | Connector Pliers | × |
| PA-09 | 3509 | Micro Connector Pliers | 26 |
| PA-11 | 3511 | Wire Stripper | 28 |
| PA-12 | Discon. | Wire Stripper | × |
| PA-13 | Discon. | Wire Stripper | × |
| PA-14 | 3514 | Wire Stripper | 31 |
| PA-15 | Discon. | Connector Pliers | × |
| PA-20 | 3520 | Universal Crimping Pliers | 26 |
| PA-21 | 3521 | Universal Crimping Pliers | 26 |
| PA-30 | 3530 | Wire Stripper | 28 |
| PA-90 | 3590 | Strip Gauge | 31 |
| PA-91 | 3591 | Terminal Set | 28 |
| PA-92 | 3592 | Terminal Set | 28 |

| | | | |
|---------|---------|-----------------------------------|----|
| PA-93 | 3593 | Terminal Set | 28 |
| PAD-01 | Discon. | Handy Crimp Tool Complete Set | × |
| PAD-02 | 3539 | Handy Crimp Tool Complete Set | 28 |
| PAD-10 | 3531 | Handy Crimp Tool Frame | 27 |
| PAD-11 | 3532 | Handy Crimp Tool (S) | 27 |
| PAD-11S | 3535 | Interchangeable Die Set (S) | 27 |
| PAD-12 | 3533 | Handy Crimp Tool (M) | 27 |
| PAD-12S | 3536 | Interchangeable Die Set (M) | 27 |
| PAD-13 | 3534 | Handy Crimp Tool (L) | 27 |
| PAD-13S | 3537 | Interchangeable Die Set (L) | 27 |
| PAR-20 | Discon. | Ratchet Crimping Connector Pliers | × |
| PAS-30 | 3570 | Connector Extractor | 29 |
| PAS-31 | 3571 | Connector Extractor | 29 |
| PAS-32 | 3572 | Connector Extractor | 29 |
| PAS-33 | 3573 | Connector Extractor | 29 |
| PAS-34 | 3574 | Connector Extractor | 29 |
| PC-06 | 3386 | Combination Pliers | 23 |
| PC-08 | 3388 | Combination Pliers | 23 |
| PD-06 | 3376 | Side Cutting Pliers | 22 |
| PD-07 | 3377 | Side Cutting Pliers | 22 |
| PD-08 | 3378 | Side Cutting Pliers | 22 |
| PDS-01 | 3544 | Screw Removal Tool Kit | 7 |
| PGT-03 | 3543 | GT Pack (Paulownia Box) | 7 |
| PH-01 | 3401 | Lock Holder | 30 |
| PH-02 | 3402 | Lock Holder | 30 |
| PH-03 | 3403 | Lock Holder | 30 |
| PH-04 | 3404 | Lock Holder | 30 |
| PH-05 | Discon. | Lock Holder | × |
| PH-06 | Discon. | Lock Holder | × |
| PH-31 | Discon. | Electronic Snips | × |
| PH-32 | Discon. | Electronic Snips | × |
| PH-33 | 3433 | Electronic Snips | 14 |
| PH-34 | 3434 | Electronic Snips | 14 |
| PH-50 | 3450 | Combination Scissors | 13 |
| PH-51 | Discon. | Combination Scissors | × |
| PH-55 | 3455 | Combination Scissors GT | 13 |
| PH-56G | 3456 | Combination Scissors MP | 12 |
| PH-56R | 3461 | Combination Scissors MP | 12 |
| PH-56Y | 3462 | Combination Scissors MP | 12 |
| PH-57 | 3457 | Combination Scissors DP | 11 |
| PH-57G | 3458 | Combination Scissors DP | 11 |
| PH-57R | 3459 | Combination Scissors DP | 11 |
| PH-57Y | 3460 | Combination Scissors DP | 11 |
| PK-50 | 3550 | Cable Shears | 14 |
| PK-51 | 3551 | Cable Shears | 14 |
| PL-05 | 3355 | Long Flat Nose Pliers | 22 |
| PL-06 | 3356 | Long Flat Nose Pliers | 22 |
| PM-06 | 3366 | Round Nose Pliers | 22 |
| PR-15 | 3315 | Long Nose Pliers | 22 |
| PR-16 | 3316 | Long Nose Pliers | 22 |
| PR-26 | 3326 | Long Nose Pliers | 22 |
| PR-36 | 3336 | Long Nose Pliers | 22 |
| PR-46 | 3346 | Needle Nose Pliers | 22 |
| PS-01 | 3201 | Miniature Long Nose Pliers | 21 |
| PS-03 | 3203 | Miniature Needle Nose Pliers | 21 |
| PS-04 | 3204 | Miniature Flat Nose Pliers | 21 |
| PSS-01 | Discon. | S/S Long Nose Pliers | × |
| PSS-02 | Discon. | S/S Needle Nose Pliers | × |
| PSS-04 | Discon. | S/S Flat Nose Pliers(Curved) | × |
| PT-01 | 3601 | Tweezers(AA) | 33 |
| PT-02 | 3602 | Tweezers(RR) | 33 |
| PT-03 | 3603 | Tweezers(MM) | 33 |
| PT-04 | 3604 | Tweezers(I) | 33 |
| PT-05 | 3605 | Tweezers(GG) | 33 |
| PT-06 | 3606 | Tweezers(J) | 33 |
| PT-07 | 3607 | Tweezers(TS) | 33 |
| PT-08 | 3608 | Tweezers | 33 |
| PT-09 | 3609 | Tweezers | 33 |
| PT-10 | 3610 | Tweezers | 33 |
| PT-11 | 3611 | Tweezers | 33 |
| PT-12 | 3612 | Tweezers(BS) | 34 |
| PT-13 | 3613 | Tweezers | 34 |
| PT-14 | 3614 | Reverse Action Tweezers | 34 |
| PT-15 | 3615 | Tweezers | 34 |
| PT-16 | 3616 | Solid Arm Tweezers | 34 |
| PT-17 | 3617 | Solid Arm Tweezers | 34 |
| PT-19 | Discon. | SMD Tweezers | × |
| PT-20 | Discon. | SMD Tweezers | × |
| PT-21 | Discon. | SMD Tweezers | × |
| PT-22 | Discon. | SMD Tweezers | × |
| PT-23 | Discon. | SMD Tweezers | × |
| PT-24 | Discon. | SMD Tweezers | × |
| PT-25 | Discon. | SMD Tweezers | × |
| PT-26 | Discon. | SMD Tweezers | × |
| PT-28 | Discon. | SMD Tweezers | × |
| PT-31 | 3629 | Solid Arm Tweezers | 34 |
| PTK-90 | 3690 | Tweezers' Soft Case | 34 |
| PTN-01 | 3661 | Titanium Tweezers(AA) | 34 |
| PTN-02 | 3662 | Titanium Tweezers(GG) | 34 |
| PTN-03 | 3653 | Titanium Tweezers(J) | 34 |
| PTN-04 | Discon. | Titanium Tweezers(TS) | × |

| | | | |
|--------|---------|-------------------------------|----|
| PTS-01 | 3671 | Tweezers | 36 |
| PTS-02 | 3672 | Tweezers | 36 |
| PTS-03 | 3673 | Tweezers | 36 |
| PTS-04 | 3674 | Tweezers | 36 |
| PTS-05 | 3675 | Tweezers | 36 |
| PTS-06 | 3676 | Tweezers | 36 |
| PTS-07 | 3677 | Tweezers | 36 |
| PTS-08 | 3678 | Tweezers | 36 |
| PTZ-01 | Discon. | Wafer Handling Tweezers | × |
| PTZ-41 | 3693 | ESD Plastic-Tipped Tweezers | 35 |
| PTZ-42 | 3694 | ESD Plastic-Tipped Tweezers | 35 |
| PTZ-43 | 3697 | ESD Plastic-Tipped Tweezers | 35 |
| PTZ-45 | 3703 | ESD Plastic-Tipped Tweezers | 35 |
| PTZ-46 | 3704 | ESD Plastic-Tipped Tweezers | 35 |
| PTZ-51 | 3701 | Ceramic-Tipped Tweezers | 36 |
| PTZ-61 | 3707 | Black-Coated ESD Tweezers | 36 |
| PTZ-62 | 3708 | Black-Coated ESD Tweezers | 36 |
| PTZ-63 | 3709 | Black-Coated ESD Tweezers | 36 |
| PTZ-91 | 3695 | Spare Tip for PTZ-41 | 35 |
| PTZ-92 | 3696 | Spare Tip for PTZ-42 | 35 |
| PTZ-93 | 3698 | Spare Tip for PTZ-43 | 35 |
| PTZ-94 | 3702 | Spare Tip for PTZ-51 | 36 |
| PTZ-95 | 3705 | Spare Tip for PTZ-45 | 35 |
| PTZ-96 | 3706 | Spare Tip for PTZ-46 | 35 |
| PW-05 | 3395 | Water Pump Pliers | 23 |
| PW-08 | 3398 | Water Pump Pliers | 23 |
| PW-10 | 3390 | Water Pump Pliers | 23 |
| PZ-01 | 3901 | E-Ring Pliers | 23 |
| PZ-02 | 3902 | E-Ring Pliers | 23 |
| PZ-10 | Discon. | Snap Ring Pliers | × |
| PZ-11 | Discon. | Tip for Snap Ring Pliers 0.7S | × |
| PZ-12 | Discon. | Tip for Snap Ring Pliers 0.7C | × |
| PZ-13 | Discon. | Tip for Snap Ring Pliers 1.4S | × |
| PZ-14 | Discon. | Tip for Snap Ring Pliers 1.4C | × |
| PZ-16 | 3916 | Snap Ring Pliers | 23 |
| PZ-17 | 3917 | Snap Ring Pliers | 23 |
| PZ-18 | 3918 | Snap Ring Pliers | 23 |
| PZ-19 | 3919 | Snap Ring Pliers | 23 |
| PZ-22 | 3900 | Screw Eater | 3 |
| PZ-32 | 3932 | Screw Removal Pliers JS | 6 |
| PZ-55 | 3955 | Screw Removal Pliers | 5 |
| PZ-56 | 3956 | Screw Removal Pliers XP | 5 |
| PZ-57 | 3957 | Screw Removal Pliers M2 | 5 |
| PZ-58 | 3958 | Screw Removal Pliers GT | 4 |
| PZ-59 | 3959 | Screw Removal Pliers RX | 4 |
| PZ-60 | 3962 | Screw Removal Pliers Z | 4 |
| PZ-64 | 3967 | Screw Removal Locking Pliers | 6 |
| PZ-65 | 3968 | Screw Removal Locking Pliers | 6 |
| PZM-30 | 3964 | Pliers Mask for PZ-32 | 6 |
| PZM-58 | 3963 | Pliers Mask for PZ-58 | 4 |

S

| ITEM No. | CODE No. | ITEM | PAGE |
|----------|----------|-------------------------------|------|
| SD-06 | Discon. | Digital Multimeter | × |
| SD-07 | Discon. | Iron Thermometer | × |
| SD-10 | 5710 | Digital Multimeter | 77 |
| SD-20 | 5720 | Desoldering Tool | 74 |
| SD-21 | 5721 | Heater Holder | 74 |
| SD-22 | 5722 | Heater Assy | 74 |
| SD-23 | 5723 | Pipe Setter | 74 |
| SD-24 | 5724 | Filter Cartridge | 74 |
| SD-25 | 5725 | Seat Valve | 74 |
| SD-26 | 5726 | Diaphragm | 74 |
| SD-29 | 5729 | Filter Pipe | 74 |
| SD-30 | 5730 | Smd Accessory Kit | 74 |
| SD-31 | 5731 | Stainless Wire Reel | 74 |
| SD-58 | Discon. | Sensor Probe | × |
| SD-60 | 5760 | Tool Stand for SD-20 | 74 |
| SD-61 | 5761 | φ0.8 Tip for SD-20 | 74 |
| SD-62 | 5762 | φ1.0 Tip for SD-20 | 74 |
| SD-63 | 5763 | φ1.5 Tip for SD-20 | 74 |
| SD-86 | 5786 | Hot Air Nozzle | 74 |
| SD-87 | 5787 | Tapering Slim Tip | 74 |
| SD-88 | 5788 | Tapering Slim Tip | 74 |
| SH-10 | 5410 | Replacement Heater (100V) | 70 |
| SH-12 | 5412 | Replacement Heater (220-240V) | 71 |
| SH-20 | 5420 | Replacement Heater (100V) | 70 |
| SK-14 | Discon. | Soldering Iron (Mica) | × |
| SK-30 | 5030 | Soldering Iron | 70 |
| SK-31 | 5031 | Soldering Iron | 70 |
| SK-32 | 5032 | Soldering Iron (100V) | 70 |
| SK-40 | 5040 | Soldering Iron (100V) | 70 |
| SK-41 | 5041 | Soldering Iron (100V) | 70 |
| SK-42 | 5042 | Tapered Needle for SKM-40 | 73 |
| SK-43 | 5043 | Chisel for SKM-40 | 73 |
| SK-44 | 5044 | φ2mm Spade for SKM-40 | 73 |
| SK-45 | 5045 | Chisel for SKM-40 | 73 |
| SK-46 | 5046 | Hot Blow Tip for SKM-40 | 73 |

| | | | |
|--------|---------|------------------------------------------|----|
| SK-47 | 5047 | Ejector Unit for SKM-40 | 73 |
| SK-50 | Discon. | Kotelyzer | 73 |
| SK-51 | Discon. | Tapered Needle for SK-50 | 73 |
| SK-52 | Discon. | Chisel for SK-50 | 73 |
| SK-53 | Discon. | φ2mm Spade for SK-50 | 73 |
| SK-54 | Discon. | Chisel for SK-50 | 73 |
| SK-55 | Discon. | Hot Blow Tip for SK-50 | 73 |
| SK-56 | Discon. | Hot Blow Tip for SK-50 | 73 |
| SK-57 | Discon. | Ejector Unit for SK-50 | 73 |
| SK-61 | 5061 | Tapered Needle for SK-60 | 72 |
| SK-62 | 5062 | Chisel for SK-60 | 72 |
| SK-63 | 5063 | φ2mm Spade for SK-60 | 72 |
| SK-64 | 5064 | Chisel for SK-60 | 72 |
| SK-65 | 5065 | Hot Blow Tip for SK-60 | 72 |
| SK-66 | 5066 | Hot Blow Tip for SK-60 | 72 |
| SK-67 | 5067 | Hot Knife for SK-60 | 72 |
| SK-68 | 5068 | Ceramic Unit for SK-60 | 72 |
| SK-70 | Discon. | Kotelyzer | 73 |
| SK-71 | 5071 | Tapered Needle for SK-70 | 73 |
| SK-72 | 5072 | Chisel for SK-70 | 73 |
| SK-73 | 5073 | φ2mm Spade for SK-70 | 73 |
| SK-74 | 5074 | φ3mm Spade for SK-70 | 73 |
| SK-75 | 5075 | Tapered Needle for SK-70 | 73 |
| SK-76 | 5076 | φ2mm Spade for SK-70 | 73 |
| SK-77 | 5077 | Tapered Pyramid for SK-70 | 73 |
| SK-78 | 5078 | Offset Tapered Needle for SK-70 | 73 |
| SK-79 | 5079 | High Powered Chisel for SK-70 | 73 |
| SK-80 | 5080 | High Powered Round Head Needle for SK-70 | 73 |
| SK-81 | 5081 | High Powered Long Taper Chisel for SK-70 | 73 |
| SK-82 | 5082 | Hot Blow Tip for SK-70 | 73 |
| SK-83 | 5083 | Hot Blow Tip for SK-70 | 73 |
| SK-84 | 5084 | Hot Blow Tip for SK-70 | 73 |
| SK-85 | 5085 | Hook Fitting for SK-70 | 73 |
| SK-88 | 5088 | Protective Cap for SK-70 | 73 |
| SK-89 | 5089 | Cleaning Sponge for Kotelyzer | 72 |
| SK-90 | 5090 | Gas Refill for Kotelyzer | 73 |
| SK-93 | 5093 | Heat Shrink for SK-70 | 73 |
| SK-94 | 5094 | Heat Shrink for SK-70 | 73 |
| SK-95 | 5095 | Gas Refill for Kotelyzer | 73 |
| SK-96 | 5096 | Ceramic Unit for SK-70 | 73 |
| SKA-50 | Discon. | Kotelyzer | 72 |
| SKA-60 | 5105 | Kotelyzer | 72 |
| SKA-70 | 5101 | Kotelyzer | 73 |
| SKB-60 | 5106 | Kotelyzer | 72 |
| SKB-70 | 5102 | Kotelyzer | 73 |
| SKC-30 | 5130 | Soldering Iron | 70 |
| SKC-31 | 5131 | Soldering Iron | 70 |
| SKC-32 | 5132 | Soldering Iron (100V) | 70 |
| SKC-40 | 5140 | Soldering Iron (100V) | 70 |
| SKC-41 | 5141 | Soldering Iron (100V) | 70 |
| SKC-60 | 5107 | Kotelyzer | 72 |
| SKC-70 | 5103 | Kotelyzer | 73 |
| SKD-70 | 5104 | Kotelyzer | 73 |
| SKE-30 | 5180 | Soldering Iron | 70 |
| SKE-31 | 5181 | Soldering Iron | 70 |
| SKE-32 | Discon. | Soldering Iron (100V) | 70 |
| SKE-40 | Discon. | Soldering Iron (100V) | 70 |
| SKE-41 | Discon. | Soldering Iron (100V) | 70 |
| SKM-40 | 5108 | Handy Kotelyzer | 73 |
| SL-01 | 5801 | Inspection Mirror | 79 |
| SL-02 | 5802 | Inspection Mirror | 79 |
| SL-03 | 5803 | Inspection Mirror | 79 |
| SL-04 | 5804 | Desk-Top Loupe | 79 |
| SL-07 | 5807 | Desk-Top Loupe | 79 |
| SL-11 | 5811 | Inspection Mirror | 79 |
| SL-12 | 5812 | Inspection Loupe | 78 |
| SL-22 | 5822 | LED Light Loupe | 79 |
| SL-23 | 5823 | LED Stand Loupe | 79 |
| SL-50 | 5850 | Pocket Loupe | 78 |
| SL-51 | 5851 | Pocket Loupe | 78 |
| SL-52 | 5852 | Pocket Loupe | 78 |
| SL-53 | 5853 | Pocket Loupe | 78 |
| SL-55 | 5855 | Inspection Loupe | 78 |
| SL-56 | 5856 | Inspection Loupe | 78 |
| SL-57 | 5857 | Inspection Loupe | 78 |
| SL-58 | Discon. | Inspection Loupe | 78 |
| SL-60 | Discon. | Stereo Microscope | 78 |
| SL-62 | Discon. | Microscope Cmos Camera | 78 |
| SL-64 | 5896 | Foldable Magnifier | 78 |
| SL-65 | Discon. | Eyeiece with Micro Scale | 78 |
| SL-66 | Discon. | Eyeiece with Micro Scale | 78 |
| SL-71 | 5871 | Flashlight Loupe | 79 |
| SL-72 | 5872 | Utility Loupe | 79 |
| SL-80 | 5880 | Head Loupe | 79 |
| SL-81 | 5881 | Head Loupe | 79 |
| SL-82 | 5882 | Head Loupe | 79 |
| SL-83 | 5883 | Head Loupe | 79 |
| SL-85 | 5885 | Replacement Lens for Head Loupe | 79 |
| SL-86 | 5886 | Replacement Lens for Head Loupe | 79 |
| SL-87 | 5887 | Replacement Lens for Head Loupe | 79 |
| SL-88 | 5888 | Replacement Lens for Head Loupe | 79 |

| | | | |
|--------|---------|----------------------------|----|
| SS-01 | 5501 | Solder Sucker | 75 |
| SS-02 | 5502 | Solder Sucker | 75 |
| SS-05 | 5505 | Tip Cleaner | 75 |
| SS-08 | 5508 | Ic Extractor | 72 |
| SS-09 | Discon. | Soldering Box | 72 |
| SS-10 | 5510 | PCB Connector Extractor | 72 |
| SS-11 | 5511 | Replacement Nozzle | 75 |
| SS-15 | 5515 | 2P-3P Plug Converter | 74 |
| SS-16 | 5516 | Replacement Silicone Tubes | 75 |
| SS-20 | 5520 | Iron Stand | 75 |
| SS-21 | 5521 | Spring Hook | 30 |
| SS-22 | 5522 | Spring Hook | 30 |
| SS-30 | 5530 | Pin Extractor | 29 |
| SS-31 | 5531 | Pin Extractor | 29 |
| SS-32 | 5532 | Pin Extractor | 29 |
| SS-33 | 5533 | Pin Extractor | 29 |
| SS-34 | 5534 | Pin Extractor | 29 |
| ST-10 | 5210 | Replacement Tip for SK-30 | 70 |
| ST-11 | 5211 | Replacement Tip for SK-30 | 70 |
| ST-12 | 5212 | Replacement Tip for SK-30 | 70 |
| ST-13 | 5213 | Replacement Tip for SK-30 | 70 |
| ST-14 | 5214 | Replacement Tip for SK-30 | 70 |
| ST-20 | 5220 | Replacement Tip | 70 |
| ST-21 | 5221 | Replacement Tip | 70 |
| ST-22 | 5222 | Replacement Tip | 70 |
| ST-23 | 5223 | Replacement Tip | 70 |
| SW-11 | 5611 | Solder | 77 |
| SW-12 | 5612 | Solder | 77 |
| SW-13 | 5613 | Solder | 77 |
| SW-21 | 5621 | Solder | 77 |
| SW-22 | 5622 | Solder | 77 |
| SW-23 | 5623 | Solder | 77 |
| SW-30 | 5630 | Solder | 77 |
| SW-31 | 5631 | Solder | 77 |
| SW-32 | 5632 | Solder | 77 |
| SW-33 | 5633 | Solder | 77 |
| SW-41 | 5641 | Solder | 77 |
| SW-42 | 5642 | Solder | 77 |
| SW-43 | 5643 | Solder | 77 |
| SW-51 | 5651 | Solder | 77 |
| SW-52 | 5652 | Solder | 77 |
| SW-53 | 5653 | Solder | 77 |
| SWA-06 | 4006 | Superiot RA Solder | 76 |
| SWA-08 | 4008 | Superiot RA Solder | 76 |
| SWA-10 | 4010 | Superiot RA Solder | 76 |
| SWA-12 | 4012 | Superiot RA Solder | 76 |
| SWA-56 | 4056 | Superiot RA Solder | 76 |
| SWA-58 | 4058 | Superiot RA Solder | 76 |
| SWA-60 | 4060 | Superiot RA Solder | 76 |
| SWA-62 | 4062 | Superiot RA Solder | 76 |
| SWA-76 | 4076 | Superiot RA Solder | 76 |
| SWA-78 | 4078 | Superiot RA Solder | 76 |
| SWA-80 | 4080 | Superiot RA Solder | 76 |
| SWA-82 | 4082 | Superiot RA Solder | 76 |
| SWS-06 | 4106 | Superiot RMA Solder | 76 |
| SWS-08 | 4108 | Superiot RMA Solder | 76 |
| SWS-10 | 4110 | Superiot RMA Solder | 76 |
| SWS-12 | 4112 | Superiot RMA Solder | 76 |
| SWS-56 | 4156 | Superiot RMA Solder | 76 |
| SWS-58 | 4158 | Superiot RMA Solder | 76 |
| SWS-60 | 4160 | Superiot RMA Solder | 76 |
| SWS-62 | 4162 | Superiot RMA Solder | 76 |
| SWS-76 | 4176 | Superiot RMA Solder | 76 |
| SWS-78 | 4178 | Superiot RMA Solder | 76 |
| SWS-80 | 4180 | Superiot RMA Solder | 76 |
| SWS-82 | 4182 | Superiot RMA Solder | 76 |
| SWU-02 | 5605 | Solder Wick | 76 |
| SWU-03 | 5606 | Solder Wick | 76 |
| SWU-04 | 5607 | Solder Wick | 76 |
| SWU-05 | 5608 | Solder Wick | 76 |
| SWU-06 | 5609 | Solder Wick | 76 |



| ITEM No. | CODE No. | ITEM | PAGE |
|----------|----------|-------------|------|
| TD-03 | 6403 | Twist Drill | 56 |
| TD-04 | 6404 | Twist Drill | 56 |
| TD-05 | 6405 | Twist Drill | 56 |
| TD-06 | 6406 | Twist Drill | 56 |
| TD-07 | 6407 | Twist Drill | 56 |
| TD-08 | 6408 | Twist Drill | 56 |
| TD-09 | 6409 | Twist Drill | 56 |
| TD-10 | 6410 | Twist Drill | 56 |
| TD-12 | 6412 | Twist Drill | 56 |
| TD-15 | 6415 | Twist Drill | 56 |
| TD-16 | 6416 | Twist Drill | 56 |
| TD-18 | 6418 | Twist Drill | 56 |
| TD-20 | 6420 | Twist Drill | 56 |
| TD-25 | 6425 | Twist Drill | 56 |

| | | | |
|--------|---------|--------------------------------|----|
| TD-30 | 6430 | Twist Drill | 56 |
| TD-32 | 6432 | Twist Drill | 56 |
| TD-35 | 6435 | Twist Drill | 56 |
| TD-40 | 6440 | Twist Drill | 56 |
| TD-50 | 6450 | Twist Drill | 56 |
| TD-60 | 6460 | Twist Drill | 56 |
| TDS-01 | 6471 | Twist Drill Set | 56 |
| TDS-02 | 6472 | Twist Drill Set | 56 |
| TDS-03 | 6473 | Twist Drill Set | 56 |
| TF-01 | Discon. | File | 57 |
| TF-02 | Discon. | File | 57 |
| TF-03 | Discon. | File | 57 |
| TF-04 | Discon. | File | 57 |
| TF-05 | Discon. | File | 57 |
| TF-06 | 6536 | File | 57 |
| TF-07 | 6537 | File | 57 |
| TF-10 | 6540 | File | 57 |
| TF-11 | 6541 | Jet Black File | 58 |
| TF-12 | 6542 | Jet Black File | 58 |
| TF-13 | 6543 | Jet Black File | 58 |
| TF-14 | 6547 | Jet Black File | 58 |
| TF-15 | 6548 | Jet Black File | 58 |
| TF-21 | 6544 | Jet Black File | 58 |
| TF-22 | 6545 | Jet Black File | 58 |
| TF-23 | 6546 | Jet Black File | 58 |
| TF-24 | 6549 | Jet Black File | 58 |
| TF-25 | 6550 | Jet Black File | 58 |
| TF-31 | 6641 | Jet Black File | 58 |
| TF-32 | 6642 | Jet Black File | 58 |
| TF-33 | 6643 | Jet Black File | 58 |
| TF-34 | 6644 | Jet Black File | 58 |
| TF-35 | 6645 | Jet Black File | 58 |
| TF-41 | 6646 | Jet Black File | 58 |
| TF-42 | 6647 | Jet Black File | 58 |
| TF-43 | 6648 | Jet Black File | 58 |
| TF-44 | 6649 | Jet Black File | 58 |
| TF-45 | 6650 | Jet Black File | 58 |
| TFS-01 | 6551 | File Set | 58 |
| TFS-02 | 6552 | File Set | 58 |
| TFS-03 | Discon. | File Set(Precise Type) | 58 |
| TFS-04 | Discon. | File Set(Precise Type) | 58 |
| TFS-06 | Discon. | File Set(Precise Type) | 58 |
| TFS-07 | 6557 | Jet Black File Set | 58 |
| TFS-10 | 6558 | Jet Black File Set | 58 |
| TFS-20 | 6559 | Jet Black File Set | 58 |
| TFS-30 | 6560 | Jet Black File Set | 58 |
| TG-02 | Discon. | Grinder | 57 |
| TH-01 | Discon. | Hammer | 57 |
| TH-02 | Discon. | Hammer | 57 |
| TH-05 | Discon. | Hammer | 57 |
| TM-04 | 6624 | Steel Rule | 57 |
| TM-05 | 6625 | Steel Rule | 57 |
| TN-01 | 6101 | Jeweller's Saw | 57 |
| TN-02 | 6102 | Jeweller's Saw | 57 |
| TN-03 | 6103 | Jeweller's Saw | 57 |
| TN-04 | 6104 | Jeweller's Saw | 57 |
| TN-05 | 6105 | Jeweller's Saw | 57 |
| TN-11 | 6111 | Saw Blade | 57 |
| TN-12 | 6112 | Saw Blade | 57 |
| TN-13 | 6113 | Saw Blade | 57 |
| TN-14 | 6114 | Saw Blade | 57 |
| TN-15 | 6115 | Saw Blade | 57 |
| TN-16 | 6116 | Saw Blade | 57 |
| TN-17 | 6117 | Saw Blade | 57 |
| TN-18 | 6118 | Saw Blade | 57 |
| TP-20 | 6020 | Mini Drill Chuck | 56 |
| TP-21 | Discon. | Pin Vise | 56 |
| TP-22 | Discon. | Pin Vise | 56 |
| TP-23 | 6023 | Pin Vise | 56 |
| TP-24 | 6024 | Pin Vise | 56 |
| TP-25 | Discon. | Pin Vise(for Drilling Machine) | 56 |
| TP-26 | Discon. | Pin Vise(for Mini Motor) | 56 |
| TP-28 | Discon. | Pin Vise(for Mini Motor) | 56 |
| TP-31 | Discon. | Pick-Up Tool | 30 |
| TP-33 | 6033 | Pick-Up Tool | 30 |
| TP-34 | 6034 | Pick-Up Tool | 30 |
| TP-35 | 6035 | Magnetic Pick-Up Tool | 30 |
| TP-36 | 6036 | Magnetic Pick-Up Tool | 30 |
| TR-01 | 6611 | Taper Reamer | 56 |
| TR-02 | 6612 | Taper Reamer | 56 |
| TR-03 | 6613 | Taper Reamer | 56 |
| TR-04 | 6614 | Taper Reamer | 56 |
| TS-01 | Discon. | Mini Spanner Set | 52 |
| TS-02 | Discon. | Mini Spanner Set | 52 |
| TS-04 | 6364 | Mini Combination Spanner Set | 52 |
| TS-05 | 6365 | Open-End Wrench Set | 52 |
| TS-06 | 6366 | Combination Wrench Set | 52 |
| TS-07 | 6367 | Combination Wrench Set | 52 |
| TS-11 | Discon. | Spanner(Flat Head) | 52 |
| TS-12 | Discon. | Spanner(Flat Head) | 52 |
| TS-13 | Discon. | Spanner(Flat Head) | 52 |

| | | | |
|--------|---------|----------------------------------|----|
| TS-14 | Discon. | Spanner(Flat Head) | ✕ |
| TS-15 | Discon. | Spanner(Flat Head) | ✕ |
| TS-21 | Discon. | Spanner(Inclined Head) | ✕ |
| TS-22 | Discon. | Spanner(Inclined Head) | ✕ |
| TS-23 | Discon. | Spanner(Inclined Head) | ✕ |
| TS-24 | Discon. | Spanner(Inclined Head) | ✕ |
| TS-25 | Discon. | Spanner(Inclined Head) | ✕ |
| TS-41 | 6281 | Combination Spanner | 52 |
| TS-42 | 6282 | Combination Spanner | 52 |
| TS-43 | 6283 | Combination Spanner | 52 |
| TS-44 | 6284 | Combination Spanner | 52 |
| TS-45 | 6285 | Combination Spanner | 52 |
| TS-46 | 6286 | Combination Spanner | 52 |
| TS-47 | 6287 | Combination Spanner | 52 |
| TS-48 | 6288 | Combination Spanner | 52 |
| TT-01 | 6501 | Tap Handle | 56 |
| TT-02 | 6502 | Tap Handle | 56 |
| TT-03 | 6503 | Tap Set | 56 |
| TT-10 | 6510 | Tap | 56 |
| TT-11 | 6511 | Tap | 56 |
| TT-12 | 6512 | Tap | 56 |
| TT-13 | 6513 | Tap | 56 |
| TT-14 | 6514 | Tap | 56 |
| TT-15 | 6515 | Tap | 56 |
| TT-16 | 6516 | Tap | 56 |
| TV-01 | 6561 | Bench Vise | 57 |
| TV-02 | 6562 | Bench Vise | 57 |
| TV-03 | 6563 | Bench Vise | 57 |
| TV-04 | 6564 | Bench Vise | 57 |
| TV-11 | 6571 | Anvil Vise | 57 |
| TV-12 | 6572 | Anvil Vise | 57 |
| TV-13 | 6573 | Anvil Vise | 57 |
| TV-14 | 6574 | Anvil Vise | 57 |
| TV-25 | 6585 | Yankee Vise | 57 |
| TV-26 | 6586 | Yankee Vise | 57 |
| TV-27 | 6587 | Yankee Vise | 57 |
| TV-31 | Discon. | Clamp | ✕ |
| TV-32 | Discon. | Clamp | ✕ |
| TV-34 | Discon. | Clamp | ✕ |
| TWB-00 | Discon. | Ball Point Hex Wrench | ✕ |
| TWB-01 | 6201 | Ball Point Hex Wrench Set (Long) | 53 |
| TWB-02 | 6202 | Ball Point Stubby Wrench Set | 53 |
| TWB-04 | 6204 | Ball Point Wrench Set (Short) | 53 |
| TWB-05 | 6205 | Ball Point Stubby Wrench Set | 53 |
| TWB-13 | 6213 | Ball Point Hex Wrench | 53 |
| TWB-15 | 6215 | Ball Point Hex Wrench | 53 |
| TWB-20 | 6220 | Ball Point Hex Wrench | 53 |
| TWB-25 | 6225 | Ball Point Hex Wrench | 53 |
| TWB-30 | 6230 | Ball Point Hex Wrench | 53 |
| TWB-40 | 6240 | Ball Point Hex Wrench | 53 |
| TWB-50 | 6250 | Ball Point Hex Wrench | 53 |
| TWB-60 | 6260 | Ball Point Hex Wrench | 53 |
| TWB-80 | 6280 | Ball Point Hex Wrench | 53 |
| TWH-01 | 6301 | Hex Key Wrench Set | 53 |
| TWH-02 | 6302 | Hex Key Wrench Set | 53 |
| TWH-04 | 6304 | Hex Key Wrench Set | 53 |
| TWH-11 | 6311 | Hex Key Wrench | 53 |
| TWH-12 | 6312 | Hex Key Wrench | 53 |
| TWH-13 | 6313 | Hex Key Wrench | 53 |
| TWH-14 | 6314 | Hex Key Wrench | 53 |
| TWH-15 | 6315 | Hex Key Wrench | 53 |
| TWH-16 | 6316 | Hex Key Wrench | 53 |
| TWH-17 | 6317 | Hex Key Wrench | 53 |
| TWH-18 | 6318 | Hex Key Wrench | 53 |
| TWH-20 | 6320 | Hex Key Wrench | 53 |
| TWH-21 | 6321 | Hex Key Wrench | 53 |
| TWH-22 | 6322 | Hex Key Wrench | 53 |
| TWH-23 | 6323 | Hex Key Wrench | 53 |
| TWH-24 | 6324 | Hex Key Wrench | 53 |
| TWH-25 | 6325 | Hex Key Wrench | 53 |
| TWH-26 | Discon. | Hex Key Wrench | ✕ |
| TWM-01 | 6351 | Adjustable Angle Wrench | 51 |
| TWM-02 | 6352 | Adjustable Angle Wrench | 51 |
| TWM-03 | 6353 | Smart Monkey Wrench | 51 |
| TWM-04 | 6354 | Adjustable Angle Wrench | 51 |
| TWM-05 | 6355 | Adjustable Angle Wrench | 51 |
| TWM-07 | 6357 | Smart Monkey Wrench | 51 |
| TWM-08 | 6358 | Smart Monkey Wrench | 51 |
| TWS-01 | 6341 | Socket Wrench Set (Inch Size) | 54 |
| TWS-02 | 6342 | Socket Wrench Set | 54 |
| TWS-03 | 6343 | Socket Wrench Set | 54 |
| TWS-04 | 6344 | Socket Wrench Set | 54 |
| TWS-05 | 6345 | Socket Wrench Set | 54 |
| TZ-02 | 6902 | Handy Saw | 57 |
| TZ-03 | 6903 | Hack Saw | 57 |
| TZ-04 | 6904 | Replacement Blade | 57 |
| TZ-05 | 6905 | Scriber | 57 |
| TZ-07 | 6907 | Punch | 57 |
| TZ-08 | Discon. | Anvil | ✕ |

Z

| ITEM No. | CODE No. | ITEM | PAGE |
|----------|----------|------------------------------|------|
| ZC-01 | 9001 | Conductive Foam | 81 |
| ZC-02 | 9002 | Conductive Foam | 81 |
| ZC-03 | Discon. | Conductive Foam | ✕ |
| ZC-11 | Discon. | Super Oil Spray | ✕ |
| ZC-12 | Discon. | Handy Grease Spray | ✕ |
| ZC-13 | Discon. | Silicon Oil | ✕ |
| ZC-14 | Discon. | Oil | ✕ |
| ZC-15 | Discon. | Tap & Drill Oil | ✕ |
| ZC-16 | Discon. | Rust Preventive | ✕ |
| ZC-17 | Discon. | Silicon Grease | ✕ |
| ZC-18 | Discon. | Super Grease | ✕ |
| ZC-19 | 9019 | Oiler | 84 |
| ZC-28 | 9028 | Rust Remover | 84 |
| ZC-31 | Discon. | Aero Duster | ✕ |
| ZC-32 | Discon. | Aero Duster | ✕ |
| ZC-38 | 9038 | Dust-Free Gloves (S) | 82 |
| ZC-39 | 9039 | Dust-Free Gloves (M) | 82 |
| ZC-40 | 9040 | Dust-Free Gloves (L) | 82 |
| ZC-41 | 9041 | Dust-Free Gloves (S) | 82 |
| ZC-42 | 9042 | Dust-Free Gloves (M) | 82 |
| ZC-43 | 9043 | Dust-Free Gloves (L) | 82 |
| ZC-44 | 9044 | Static Conductive Gloves (S) | 82 |
| ZC-45 | 9045 | Static Conductive Gloves (M) | 82 |
| ZC-46 | 9046 | Static Conductive Gloves (L) | 82 |
| ZC-47 | 9047 | Static Conductive Gloves (S) | 82 |
| ZC-48 | 9048 | Static Conductive Gloves (M) | 82 |
| ZC-49 | 9049 | Static Conductive Gloves (L) | 82 |
| ZC-50 | 9050 | Wrist Strap | 81 |
| ZC-51 | 9051 | Anti-Static Gloves (S) | 82 |
| ZC-52 | 9052 | Anti-Static Gloves (M) | 82 |
| ZC-53 | 9053 | Anti-Static Gloves (L) | 82 |
| ZC-54 | 9054 | Anti-Static Gloves (S) | 82 |
| ZC-55 | 9055 | Anti-Static Gloves (M) | 82 |
| ZC-56 | 9056 | Anti-Static Gloves (L) | 82 |
| ZC-62 | 9062 | Ground Cord | 83 |
| ZC-63 | 9063 | Connective Plate | 83 |
| ZC-70 | 9070 | Flux | 74 |
| ZC-71 | 9071 | Flux Dispenser | 74 |
| ZC-80 | 9080 | Anti-Static Service Kit | 81 |
| ZC-82 | 9082 | Static Conductive Bag | 82 |
| ZC-84 | 9084 | Static Conductive Bag | 82 |
| ZC-86 | 9086 | Static Conductive Bag | 82 |
| ZC-92 | 9092 | Anti-Static Bag | 82 |
| ZC-94 | 9094 | Anti-Static Bag | 82 |
| ZC-96 | 9096 | Anti-Static Bag | 82 |
| ZCM-01 | 9121 | Conductive Colored Mat 10M | 83 |
| ZCM-02 | 9122 | Conductive Colored Mat 2M | 83 |
| ZCM-03 | 9123 | Conductive Colored Mat 1M | 83 |
| ZCM-04 | 9124 | Conductive Colored Mat 0.5M | 83 |

ENGINEER INC.

**2-8-9 HIGASHI-IMAZATO, HIGASHINARI-KU,
OSAKA 537-0011, JAPAN**

TEL +81-6-6974-0028

FAX +81-6-6974-5661

WEB <http://www.engineer.jp>



X-ON Electronics

Largest Supplier of Electrical and Electronic Components

Click to view similar products for [Antistatic Control Products](#) category:

Click to view products by [Engineer manufacturer](#):

Other Similar products are found below :

[13020](#) [13490](#) [13870](#) [13879](#) [13881](#) [13883](#) [13882](#) [14404](#) [2202SP](#) [2229](#) [2230](#) [300515](#) [3039](#) [37061](#) [42470](#) [09060](#) [09857](#) [42516](#) [37059](#)
[04563](#) [17252](#) [19691](#) [19695](#) [09037](#) [09826](#) [09813](#) [66070](#) [100816](#) [68101](#) [68103](#) [98132](#) [73741](#) [13868](#) [13485](#) [13457](#) [13245](#) [13440](#) [13420](#)
[13332](#) [13205](#) [13135](#) [91070](#) [8031](#) [8523](#) [66085](#) [5822448](#) [40931](#) [37113](#) [37109](#) [37081](#)