



Main catalogue

# SNK Series Terminal Blocks Accessories Marking Solutions

# SNK Series, Terminal Blocks

**Summary** See page 7

**Quickly find** all information in one DVD-rom

**Quick search with:**

- Document ID,
- Product part number,
- Product designation.

Catalogue Page  
**1SNK 161 001 S0201**

Technical Datasheet  
**1SNK 161 001 D0201**

**Softwares:**

- Printing softwares,
- Easy Rail Designer.



**CAD Outline Drawings**



**Build-up your own documentation in PDF files:**

- Catalogue,
- Technical data sheets,
- Certificates,
- Photos,
- Operating instructions,
- Declarations of conformity.



1SNK16102850201

# SNK Series, Terminal Blocks

Screw clamp terminal blocks  
Accessories  
Marking solutions



## 1 A Smart Design to Support your daily Connection Challenges

- Marking visible from any direction
- Rail assembly process facilitated
- Facilitated maintenance operations

## 2 Rely on our Expertise

- CB certification and worldwide agreements
- Innovation with 14 new patents deposit
- Reliability: screw clamp benefit from 50 years of expertise

## 3 Make Savings where it Counts

- Up to 20 % size reduction for SNK series terminal assemblies
- 1 identical end plate for most of the SNK terminal blocks
- Less terminal blocks and accessories needed to do an electrical installation

## 4 Find your preferred Marking Solution from our Universal Range

- SNK terminal blocks and accessories accept markers cards, self-adhesive paper strips or universal wire marker holders
- Complete marking system choice: ABB automatic printing solutions or manual marking solutions

# SNK Series, Terminal Blocks

A complete set of terminal blocks  
to fit your essential functions

## Feed-through

20% Size Reduction



### A unique profile for smart use

Easy and ergonomic mounting thanks to the unique profile of the terminal blocks:

- Easy to handle,
- Reverse mounting error-free.

### Clear marking areas

Marking surfaces can be read clearly from any angle in an enclosure and are larger than standard markers in the market.

### Maximized flexibility

The two terminal blocks central channels-aligned from 4 mm<sup>2</sup> 10 AWG up to 16 mm<sup>2</sup> 4 AWG terminal blocks-offer flexibility of use:

- Common and polarity distribution with JB screwless jumper bars,
- Power distribution with JB85-3 cross-spacing jumpers,
- Continuity control with TP4 or TP2 test adapters,
- Advanced testing (simulation, dielectric control, etc.) prior customer acceptance with TC test connectors,
- Overvoltage protection and temperature control with PG5-R2 components holder.

### Reduce use of accessories

- One unique end section and circuit separator fits all feed-through terminal blocks.

## Double Deck

High Wiring Density  
for Space Savings



### Offers efficient space reduction for switchgears with space constraints or sensors with multiple connection constraints.

All Double Deck terminal blocks have two marking areas as well as two central channels per deck for:

- Common and polarity distribution with JB screwless jumper bars.
- Continuity control or Advanced testing (simulation, dielectric control, etc.) with TP4, TP2 test adapters and TC test connectors, on the upper deck only.

## Ground

Reliable Rail Connection



### Snap-in rail connection for rapid installation and removal for 4 mm<sup>2</sup> 10 AWG up to 16 mm<sup>2</sup> 4 AWG ground terminal blocks.

Simply snap it on the DIN3-TH35 rail and it is connected to the rail.

Strict qualification tests, in addition to those required in IEC standard 60947-2, have been performed to guarantee the reliability of the snap-in rail connection in mechanical endurance and lifetime performance.

Our smart design enables block removal without any risk of damaging the rail connection part.

Robust **screw rail connection** for higher rated sections 35 mm<sup>2</sup> 0 AWG up to 95 mm<sup>2</sup> 000 AWG ground terminal blocks.

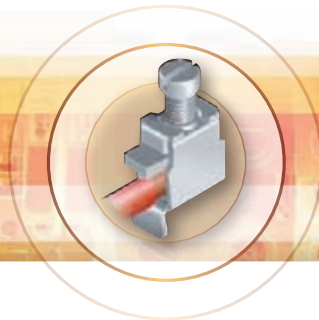

## Disconnect

### Time saving for test circuit operations

#### Compact



The **ZS4-S compact** version has an **identical profile to the ZS4 feed-through** terminal block for many benefits such as identical end section use

#### Expert



The **ZS4-S-R1 expert** version has **two central jumper channels aligned with the ZS6 feed-through** terminal block for convenient alternated distribution

#### Aligned with fuse

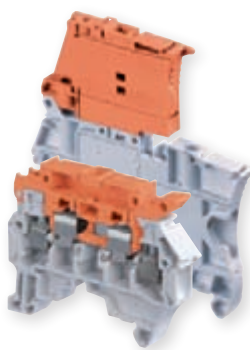

**Perfectly adapted for use with fuse terminal blocks**

**Available with blade or plug for easy circuit opening without disconnecting the wiring.**

Also available with built-in test socket screws convenient direct connection to the test equipment for the following operations:

- Voltage control, voltage continuity control or dielectric tests.
- Total or partial equipment testing.
- Maintenance.

## for Fuse

### Optimized Circuit Protection

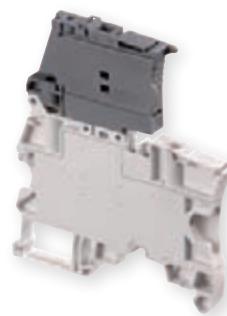

**The ZS4-SF fits 5x20 mm fuses for circuit protection**

It has two central jumper channels for convenient common distribution and it is aligned with ZS4-S-R1 and ZS4-S-R2 disconnect terminal blocks, as well as the ZS6 feed-through terminal block for convenient alternated distribution and reduced wiring.



**The ZS4-SF1 fits 5x20 mm and 5x25 mm fuses for circuit protection**

**The ZS4-SF and ZS-SF1 are based on the latest version of the IEC60947-7-3 standard.**

**The wiring of the terminal block is facilitated and can be done when the fuse holder is in closed position.**

- Easy blown fuse control with the ZS4-SF-R1 and ZS4-SF-R3 available with blown fuse indicator 24-60 V or 110-230 V for quick identification of fuse failures, with low leakage current (< 0.5 mA). This feature enables use on high impedance PLC inputs.
- Also available with built-in test socket screws for convenient direct connection to the test equipment for test operations such as voltage control, voltage continuity control or maintenance.

# SNK Series, Terminal Blocks

## A complete set of accessories

### End stops



Choose between the robust **BAM3** and the high **BAZH1** for double deck and power blocks. All compatible with label holders.

### Jumpers



Simplify the block interconnection with the isolated screwless jumper **JB...** available for 4 to 16 mm<sup>2</sup> 10 to 4 AWG terminal blocks.

### End sections



One end section **ES4** for the core feed-through range from 4 mm<sup>2</sup> to 95 mm<sup>2</sup> 10 to 000 AWG. Just three ends sections needed for the entire SNK series range.

### Circuit Separators



Separate and easily visualize different parts of your assembly with the universal circuit separator **CS-R1**.

### Testing Solutions



Test your assembly up to 15 poles with the test connector **TC...** or simply control the voltage with the test adaptor **TP** for 2, 2.3 or 4 mm test plug diameter.

### Shielding



Ensure the continuity of your shield connection with the **SHB...** shield connectors providing rapid and convenient installation.

### Covers



**PL...** individual terminal block protective covers allow the rapid identification of live circuits. They also limit access to the screw clamp.

**KCO** transparent mounting kit protective covers reliably restrict access to your terminal assembly with the possibility of sealing.

### Plugs



**PG5** component plugs ease the component installation (resistors or diodes) with a quick plug-in mounting system which avoids any soldering.

**PG5-R2** plugs fit into the terminal block's jumper channel for component insertion (resistors, diodes, etc.) between two terminal blocks.

# Marking solutions

## Blank Marker cards

For industrial use



Identify your terminal blocks with blank marker cards **MC...** printable with ABB marking systems.



## Marking Systems

For industrial use



ABB automatic printing solutions:  
**AMS 500** Plotter,  
**HTP500** Thermal Transfer Printer.

## Self Adhesive sTrips

For moderate use

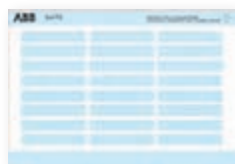

Identify your terminal blocks with Self Adhesive sTrips **SAT...** printable on all desktop printers.

## Universal Marker Holders

For moderate use



Identify your terminal blocks with Universal Marker Holders **UMH** compatible with most of the wire markers available on the market.



# SNK Series, Terminal Blocks

Quickly find

the product you need in our new catalogue pages

**Top Page quick selection featuring:**

- Function (including number of jumper channels)
- Connecting technology
- Rated section
- Spacing

All dimensions are in mm - *Inches in italic>*

*Technical data for UL/CSA standard also in italic>*

Document ID for catalogue pages and Data sheets (complete environmental, electrical and mechanical characteristics) for direct download from the enclosed DVD-rom

Worldwide certifications UL, CSA, Gost, ATEX, GL...

**ZS4 designation**

- ZS... identifies the Screw clamp SNK series terminal blocks;
- 4: rated section, in mm<sup>2</sup>
- Colours:
  - Grey (standard colour)
  - BL: Blue
  - OR: Orange
  - YL: Yellow
  - GN: Green
  - RD: Red
  - PR: Purple
  - BR: Brown
  - WH: White
  - BK: Black

**Accessories detailed**  
Catalogue pages numbers

**Quick selection of the closest compatible terminal block:** Ground terminal blocks ordering code is indicated in the Feed-through terminal blocks pages. Complete technical data remains available in the ground terminal block catalogue page.





**4 mm<sup>2</sup>**  
**12 AWG**

**ZS4 Screw Clamp Terminal Block**  
Feed-through

Catalogue Page: **1SNK 161 001 S0201**  
Technical Datasheet: **1SNK 161 001 D0201**

---

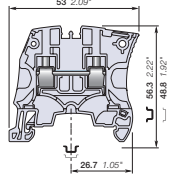
**5.2 mm 0.205 in spacing**

**Features and Benefits**  
Save space by connecting conductors up to 4 mm<sup>2</sup> (CB certified) 12 AWG in just 5.2 mm 0.205 in spacing.

Main Technical Data		IEC	cULus - CSA
Connecting capacity	with 1 conductor per clamp	Rigid 0.2-4 mm <sup>2</sup>	24-10 AWG
	with ferrule	Flexible 0.22-4 mm <sup>2</sup>	24-12 AWG
		Gauge A3-B3	0.22-4 mm <sup>2</sup>
with 2 conductors per clamp with twin ferrule	Rigid 0.2-1 mm <sup>2</sup>	24-18 AWG	24-18 AWG
	Flexible 0.22-1 mm <sup>2</sup>	24-18 AWG	24-16 AWG
	Gauge A3-B3	0.22-1.5 mm <sup>2</sup>	24-16 AWG
Rated cross section	4 mm <sup>2</sup>	12 AWG	
Rated current	32 A	20 A	
Rated short-time withstand current (1s)	480 A		
Rated voltage	1000 V	600 V	
Impulse withstand voltage	8000 V		
Protection	IP 20	NEMA 1	

Rated voltage Ex e 630 V (IEC/EN/UL/CSA 60073-7) IM2 II 2 GD Ex e I/II

CE CB RoHS REHS cUL CSA Gost ATEX TSCA Br-Ex BV Gost, Br-Ex, and BV: Pending - 2009

**Mounting Instructions**

Rail: DIN3-TH35

Wire stripping length: 10.5 mm (0.413 in)

Tool: Flat screwdriver (Ø 3.5 mm / Ø 0.138 in)

Torque: 0.6 Nm (± 0.085)

**Ordering Details**

**ZS4 Feed-through Screw Clamp Terminal Block**

Description	Type	Order Code	Pack <sup>no</sup> pieces	Weight g (lb. oz)
<b>Feed-through</b>	Grey <input type="checkbox"/> ZS4	1SNK 505 010 R0000	50	8.77
	Blue <input type="checkbox"/> ZS4-BL	1SNK 505 020 R0000	50	8.77
	Orange <input type="checkbox"/> ZS4-OR	1SNK 505 030 R0000	50	8.77
	Yellow <input type="checkbox"/> ZS4-YL	1SNK 505 040 R0000	50	8.77
	Green <input type="checkbox"/> ZS4-GN	1SNK 505 061 R0000	50	8.77
	Red <input type="checkbox"/> ZS4-RD	1SNK 505 062 R0000	50	8.77
	Purple <input type="checkbox"/> ZS4-PR	1SNK 505 063 R0000	50	8.77
	Brown <input type="checkbox"/> ZS4-BR	1SNK 505 064 R0000	50	8.77
	White <input type="checkbox"/> ZS4-WH	1SNK 505 065 R0000	50	8.77
	Black <input type="checkbox"/> ZS4-BK	1SNK 505 066 R0000	50	8.77

**ZS4 Terminal Block Accessories** (1SNK 160 001 C0201)

Description	Type	Order Code	Pack <sup>no</sup> pieces	Weight g (lb. oz)
1 End Stops	10 mm 0.394 in Dark Grey	BAM3 1SNK 900 001 R0000	50	13.80
2 End Sections	2.2 mm 0.087 in Dark Grey	ES4 1SNK 905 910 R0000	20	2.18
3 Jumper Bars	2 poles 32 A 30 A Orange	JB5-2 1SNK 905 302 R0000	50	1.30
	3 poles	JB5-3 1SNK 905 303 R0000	50	2.00
	4 poles	JB5-4 1SNK 905 304 R0000	50	2.70
	5 poles	JB5-5 1SNK 905 305 R0000	50	3.50
	10 poles	JB5-10 1SNK 905 310 R0000	30	7.10
50 poles	JB5-50 1SNK 905 350 R0000	10	36.10	
4 Cross Spacing Jumpers	8 mm 0.315 in to 5.2 mm 0.205 in spacing Orange	JB85-3 1SNK 900 603 R0000	10	2.80
5 Circuit Separators	0 mm 0 in Dark Grey	CS 1SNK 900 101 R0000	20	0.20
	3 mm 0.118 in Dark Grey	CS-R1 1SNK 900 103 R0000	20	5.20
6 Test Adapters	For test plugs DIA 2 mm 0.079 in Dark Grey	TP2 1SNK 900 203 R0000	20	1.73
	For test plugs DIA 4 mm 0.160 in Dark Grey	TP4 1SNK 900 205 R0000	20	2.42
7 Test Connectors	5.2 mm 0.205 in spacing Dark Grey	TCS 1SNK 900 200 R0000	10	5.23
	End module, 5.2 mm 0.205 in Dark Grey	TCS-R1 1SNK 900 201 R0000	10	5.23
8 Shield Connectors	SHBS 1SNK 900 600 R0000	20	3.50	
9 Protecting Covers	5.2 mm 0.205 in spacing Transparent	PL5 1SNK 900 618 R0000	20	1.50
10 Terminal Block Markers	Blank card White	MCS12 1SNK 140 000 R0000	22	0.06
	Universal wire markers holder Grey	UMH 1SNK 900 611 R0000	10	0.20
	Self adhesive strip White	SAT5 1SNK 900 614 R0000	5	6.00

Some accessories may modify the terminal block's ratings. See complete information in "Technical Datasheet".



**ZS4-PE Ground Screw Clamp Terminal Block**

1SNK 161 002 S0201 1SNK 161 002 D0201

Description	Type	Order Code	Pack <sup>no</sup> pieces	Weight g (lb. oz)
Ground Profile aligned with ZS4	Green-Yellow <input type="checkbox"/> ZS4-PE	1SNK 505 150 R0000	20	12.10

All the technical data for UL/CSA standard and dimensions in inches are in *italic*.

**ABB**

6

1SNK1610030201



# SNK Series Terminal Blocks

## Terminal Blocks

### Feed-through

4 mm <sup>2</sup> / 12 AWG
6 mm <sup>2</sup> / 10 AWG
10 mm <sup>2</sup> / 6 AWG
16 mm <sup>2</sup> / 4 AWG
35 mm <sup>2</sup> / 0 AWG
70 mm <sup>2</sup> / 00 AWG
95 mm <sup>2</sup> / 000 AWG
4 mm <sup>2</sup> / 10 AWG

<b>ZS4</b> .....	10
<b>ZS6</b> .....	11
<b>ZS10</b> .....	12
<b>ZS16</b> .....	13
<b>ZS35</b> .....	14
<b>ZS70</b> .....	15
<b>ZS95</b> .....	16
<b>ZS4-R1</b> ..... Profile aligned with ZS4-SF1 .....	17

### Double Deck

4 mm <sup>2</sup> / 12 AWG
6 mm <sup>2</sup> / 10 AWG

<b>ZS4-D2</b> ..... 2 feed-through circuits .....	18
<b>ZS4-D1</b> ..... 1 feed-through circuit .....	19
<b>ZS6-D2</b> ..... 2 feed-through circuits .....	20
<b>ZS6-D1</b> ..... 1 feed-through circuit .....	21

### Ground

4 mm <sup>2</sup> / 12 AWG
6 mm <sup>2</sup> / 10 AWG
10 mm <sup>2</sup> / 6 AWG
16 mm <sup>2</sup> / 4 AWG
35 mm <sup>2</sup> / 0 AWG
70 mm <sup>2</sup> / 00 AWG
95 mm <sup>2</sup> / 000 AWG

<b>ZS4-PE</b> .....	22
<b>ZS6-PE</b> .....	23
<b>ZS10-PE</b> .....	24
<b>ZS16-PE</b> .....	25
<b>ZS35-PE</b> .....	26
<b>ZS70-PE</b> .....	27
<b>ZS95-PE</b> .....	28

### Disconnect with blade

4 mm <sup>2</sup> / 10 AWG
4 mm <sup>2</sup> / 10 AWG

<b>ZS4-S</b> .....	29
<b>ZS4-S-T2</b> ..... With test Ø 2 mm .....	30
<b>ZS4-S-T2.3</b> ..... With test Ø 2.3 mm .....	30
<b>ZS4-S-R1</b> .....	31
<b>ZS4-S-T2-R1</b> ..... With test Ø 2 mm .....	32
<b>ZS4-S-T2.3-R1</b> ..... With test Ø 2.3 mm .....	32

### Disconnect with plug

4 mm <sup>2</sup> / 10 AWG
----------------------------

<b>ZS4-SP</b> .....	33
<b>ZS4-SP-T2</b> ..... With test Ø 2 mm .....	34
<b>ZS4-SP-R1</b> .....	35
<b>ZS4-SP-T2-R1</b> ..... With test Ø 2 mm .....	36

### Disconnect with lever

4 mm <sup>2</sup> / 10 AWG
----------------------------

<b>ZS4-S-R2</b> ..... Profile aligned with ZS4-SF .....	37
<b>ZS4-S-R3</b> ..... Profile aligned with ZS4-SF1 .....	38

### For 5x20 mm fuses (0.197x0.787 in)

4 mm <sup>2</sup> / 10 AWG
----------------------------

<b>ZS4-SF</b> .....	39
<b>ZS4-SF-T2</b> ..... With test Ø 2 mm .....	40
<b>ZS4-SF-R1</b> ..... With fuse indicator 24-60 V .....	41
<b>ZS4-SF-R3</b> ..... With fuse indicator 115-250 V .....	41
<b>ZS4-SF-R2</b> ..... With test Ø 2 mm and fuse indicator 24-60 V .....	42
<b>ZS4-SF-R4</b> ..... With test Ø 2 mm and fuse indicator indicator 115-250 V .....	42

### For 5x20 and 5x25 mm fuses (0.197x0.787 in and 0.197x0.984 in)

4 mm <sup>2</sup> / 10 AWG
----------------------------

<b>ZS4-SF1</b> .....	43
<b>ZS4-SF1-T2</b> ..... With test Ø 2 mm .....	44
<b>ZS4-SF1-R1</b> ..... With fuse indicator 24-60 V .....	45
<b>ZS4-SF1-R3</b> ..... With fuse indicator 115-250 V .....	45
<b>ZS4-SF1-R2</b> ..... With test Ø 2 mm and fuse indicator 24-60 V .....	46
<b>ZS4-SF1-R4</b> ..... With test Ø 2 mm and fuse indicator indicator 115-250 V .....	46

### Accessories

### Marking solutions

.....	47
.....	XX



# SNK Series, Terminal Blocks

## Feed-through

Section		Spacing			Spacing			Spacing		
mm <sup>2</sup>	AWG	mm	in		mm	in		mm	in	
4 mm <sup>2</sup>	12 AWG	5.2	0.205	ZS4				8	0.315	ZS4-R1
6 mm <sup>2</sup>	10 AWG	6	0.236	ZS6						
10 mm <sup>2</sup>	6 AWG	8	0.315	ZS10						
16 mm <sup>2</sup>	4 AWG	10	0.394	ZS16						
35 mm <sup>2</sup>	0 AWG				16	0.630	ZS35			
70 mm <sup>2</sup>	00 AWG				22	0.866	ZS70			
95 mm <sup>2</sup>	000 AWG				26	1.020	ZS95			

## Disconnect - with blade

Section		Spacing			Spacing			Spacing		Spacing			
mm <sup>2</sup>	AWG	mm	in		mm	in		mm	in	mm	in		
4 mm <sup>2</sup>	10 AWG	5.2	0.205	ZS4-S	5.2	0.205	ZS4-S-T2	6	0.236	ZS4-S-R1	6	0.236	ZS4-S-T2-R1
4 mm <sup>2</sup>	10 AWG				5.2	0.205	ZS4-S-T2.3				6	0.236	ZS4-S-T2.3-R1

## For 5 x 20 mm fuses (0.197" x 0.787")

Section		Spacing			Spacing			Spacing		Spacing		Spacing	
mm <sup>2</sup>	AWG	mm	in		mm	in		mm	in	mm	in	mm	in
4 mm <sup>2</sup>	10 AWG	6	0.236	ZS4-SF	6	0.236	ZS4-SF-T2	6	0.236	ZS4-SF-R1	6	0.236	ZS4-SF-R2
4 mm <sup>2</sup>	10 AWG							6	0.236	ZS4-SF-R3	6	0.236	ZS4-SF-R4

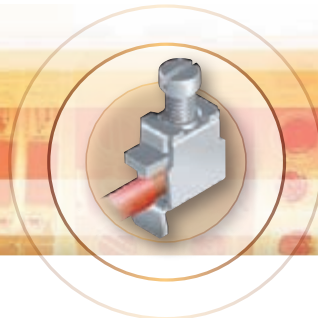

### Double Deck

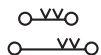

Spacing		
mm	in	
5.2	0.205	<b>ZS4-D2</b>
6	0.236	<b>ZS6-D2</b>

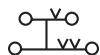

Spacing		
mm	in	
5.2	0.205	<b>ZS4-D1</b>
6	0.236	<b>ZS6-D1</b>

### Ground

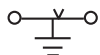

Spacing		
mm	in	
5.2	0.205	<b>ZS4-PE</b>
6	0.236	<b>ZS6-PE</b>
8	0.315	<b>ZS10-PE</b>
10	0.394	<b>ZS16-PE</b>

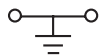

Spacing		
mm	in	
16	0.630	<b>ZS35-PE</b>
22	0.866	<b>ZS70-PE</b>
26	1.020	<b>ZS95-PE</b>

### Disconnect - with plug



Spacing		
mm	in	
5.2	0.205	<b>ZS4-SP</b>

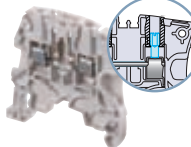
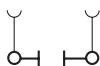

Spacing		
mm	in	
5.2	0.205	<b>ZS4-SP-T2</b>

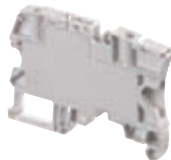

Spacing		
mm	in	
6	0.236	<b>ZS4-SP-R1</b>

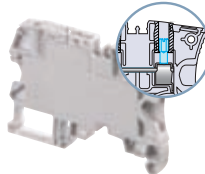
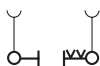

Spacing		
mm	in	
6	0.236	<b>ZS4-SP-T2-R1</b>

### Disconnect - with lever



Spacing		
mm	in	
6	0.236	<b>ZS4-S-R2</b>



Spacing		
mm	in	
8	0.315	<b>ZS4-S-R3</b>

### For 5 x 20 mm and 5 x 25 mm fuses (0.197" x .787" and 0.197" x 0.984")



Spacing		
mm	in	
8	0.315	<b>ZS4-SF1</b>

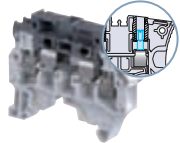
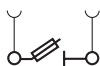

Spacing		
mm	in	
8	0.315	<b>ZS4-SF1-T2</b>

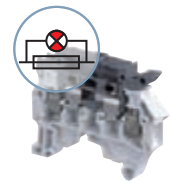

Spacing		
mm	in	
8	0.315	<b>ZS4-SF1-R1</b>
8	0.315	<b>ZS4-SF1-R3</b>

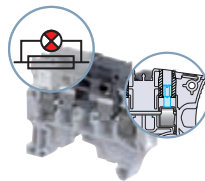

Spacing		
mm	in	
8	0.315	<b>ZS4-SF1-R2</b>
8	0.315	<b>ZS4-SF1-R4</b>



4 mm<sup>2</sup>  
12 AWG

# ZS4 Screw Clamp Terminal Block Feed-through

5.2 mm 0.205 in spacing

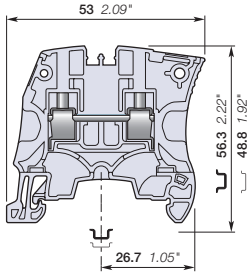

## Features and Benefits

Save space by connecting conductors up to 4 mm<sup>2</sup> (CB certified) 12 AWG in just 5.2 mm 0.205 in spacing.

## Main Technical Data

Connecting capacity		IEC	cULus - CSA
with 1 conductor per clamp	Rigid	0.2-4 mm <sup>2</sup>	24-10 AWG
	Flexible	0.22-4 mm <sup>2</sup>	24-12 AWG
	with ferrule	0.22-4 mm <sup>2</sup>	24-12 AWG
		Gauge	A3-B3
with 2 conductors per clamp	Rigid	0.2-1 mm <sup>2</sup>	24-18 AWG
	Flexible	0.22-1 mm <sup>2</sup>	24-18 AWG
	with twin ferrule	0.22-1.5 mm <sup>2</sup>	24-16 AWG
Rated cross section		4 mm <sup>2</sup>	12 AWG
Rated current		32 A	20 A
Rated short-time withstand current (1s)		480 A	
Rated voltage		1000 V	600 V
Impulse withstand voltage		8000 V	
Protection		IP 20	NEMA 1

Rated voltage Ex e 630 V (IEC/EN/cULus 60079-7) IM2 II 2 GD Ex e I/II



Gost, Br-Ex, and BV: Pending - 2009

## Mounting Instructions

Rail		DIN3-TH35
Wire stripping length		10.5 mm 0.413 in
Tool		Flat screwdriver Ø 3.5 mm Ø 0.138 in
Torque		0.6 Nm ± 0.1 5.31 lb.in ± 0.885

## Ordering Details

### ZS4 Feed-through Screw Clamp Terminal Block

Description	Type	Order Code	Pack <sup>(ing)</sup> pieces	Weight g (1 pce)
Feed-through	Grey	<b>ZS4</b>	1SNK 505 010 R0000	50 8.77
	Blue	<b>ZS4-BL</b>	1SNK 505 020 R0000	50 8.77
	Orange	<b>ZS4-OR</b>	1SNK 505 030 R0000	50 8.77
	Yellow	<b>ZS4-YL</b>	1SNK 505 060 R0000	50 8.77
	Green	<b>ZS4-GN</b>	1SNK 505 061 R0000	50 8.77
	Red	<b>ZS4-RD</b>	1SNK 505 062 R0000	50 8.77
	Purple	<b>ZS4-PR</b>	1SNK 505 063 R0000	50 8.77
	Brown	<b>ZS4-BR</b>	1SNK 505 064 R0000	50 8.77
	White	<b>ZS4-WH</b>	1SNK 505 065 R0000	50 8.77
	Black	<b>ZS4-BK</b>	1SNK 505 066 R0000	50 8.77

### ZS4 Terminal Block Accessories

1SNK 160 001 C0201

Description	Type	Order Code	Pack <sup>(ing)</sup> pieces	Weight g (1 pce)
1 <b>End Stops</b>	10 mm 0.394 in Dark Grey	<b>BAM3</b>	1SNK 900 001 R0000	50 13.80
2 <b>End Sections</b>	2.2 mm 0.087 in Dark Grey	<b>ES4</b>	1SNK 505 910 R0000	20 2.18
3 <b>Jumper Bars</b>	2 poles 32 A 30 A Orange	<b>JB5-2</b>	1SNK 905 302 R0000	50 1.30
	3 poles	<b>JB5-3</b>	1SNK 905 303 R0000	50 2.00
	4 poles	<b>JB5-4</b>	1SNK 905 304 R0000	50 2.70
	5 poles	<b>JB5-5</b>	1SNK 905 305 R0000	50 3.50
	10 poles 50 poles	<b>JB5-10</b> <b>JB5-50</b>	1SNK 905 310 R0000 1SNK 905 350 R0000	30 7.10 10 36.10
4 <b>Cross Spacing Jumpers</b>	8 mm 0.315 in to 5.2 mm 0.205 in spacing Orange	<b>JB85-3</b>	1SNK 900 603 R0000	10 2.80
5 <b>Circuit Separators</b>	0 mm 0 in Dark Grey	<b>CS</b>	1SNK 900 101 R0000	20 0.20
	3 mm 0.118 in	<b>CS-R1</b>	1SNK 900 103 R0000	20 5.20
6 <b>Test Adapters</b>	For test plugs DIA 2 mm 0.079 in Dark Grey	<b>TP2</b>	1SNK 900 203 R0000	20 1.73
	For test plugs DIA 4 mm 0.160 in	<b>TP4</b>	1SNK 900 205 R0000	20 2.42
7 <b>Test Connectors</b>	5.2 mm 0.205 in spacing Dark Grey	<b>TC5</b>	1SNK 900 200 R0000	10 5.23
	End module, 5.2 mm 0.205 in	<b>TC5-R1</b>	1SNK 900 201 R0000	10 5.23
8 <b>Shield Connectors</b>		<b>SHBS</b>	1SNK 900 600 R0000	20 3.50
9 <b>Protecting Covers</b>	5.2 mm .205 in spacing Transparent	<b>PL5</b>	1SNK 900 618 R0000	20 1.50
10 <b>Terminal Block Markers</b>	Blank card White	<b>MC512</b>	1SNK 140 000 R0000	22 0.06
	Universal wire markers holder Grey	<b>UMH</b>	1SNK 900 611 R0000	10 0.20
	Self adhesive strip White	<b>SAT5</b>	1SNK 900 614 R0000	5 6.00

Some accessories may modify the terminal block's ratings. See complete information in "Technical Datasheet".

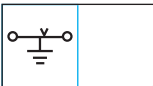

### ZS4-PE Ground Screw Clamp Terminal Block

1SNK 161 002 S0201

1SNK 161 002 D0201

Description	Type	Order Code	Pack <sup>(ing)</sup> pieces	Weight g (1 pce)
Ground Profile aligned with ZS4	Green-Yellow	<b>ZS4-PE</b>	1SNK 505 150 R0000	20 12.10

All the technical data for UL/CSA standard and dimensions in inches are in italic.



**6 mm<sup>2</sup>**  
**10 AWG**

# ZS6 Screw Clamp Terminal Block

## Feed-through

6 mm 0.236 in spacing

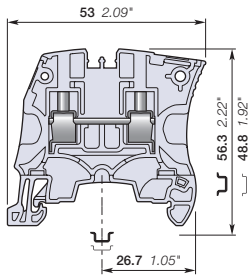

### Features and Benefits

Save space by connecting conductors up to 6 mm<sup>2</sup> 10 AWG in just 6 mm 0.236 in spacing.

### Main Technical Data

Connecting capacity	IEC	cULus - CSA
with 1 conductor per clamp	Rigid 0.2-4 mm <sup>2</sup>	24-10 AWG
	Flexible 0.22-4 mm <sup>2</sup>	24-10 AWG
	with ferrule 0.22-4 mm <sup>2</sup>	24-10 AWG
Gauge A4-B3		
with 2 conductors per clamp	Rigid 0.2-1.5 mm <sup>2</sup>	24-16 AWG
	Flexible 0.22-1.5 mm <sup>2</sup>	24-16 AWG
	with twin ferrule 0.22-1.5 mm <sup>2</sup>	24-16 AWG
Maximum cross section	6 mm <sup>2</sup>	10 AWG
Max. current / Max. cross section	41 A	30 A
Maximum short circuit current (1s)	720 A	
Rated voltage	1000 V	600 V
Impulse withstand voltage	8000 V	
Protection	IP 20	NEMA 1

### Mounting Instructions

Rail		DIN3-TH35
Wire stripping length		10.5 mm 0.413 in
Tool		Flat screwdriver Ø 4 mm Ø 0.157 in
Torque		0.85 Nm ± 0.15 7.52 lb.in ± 1.33

Rated voltage Ex e 630 V (IEC/EN/cULus 60079-7) IM2 II 2 GD Ex e I/II

											Gost, Br-Ex, and BV: Pending - 2009
--	--	--	--	--	--	--	--	--	--	--	-------------------------------------

### Ordering Details

#### ZS6 Feed-through Screw Clamp Terminal Block

Description	Type	Order Code	Pack <sup>(n)</sup> pieces	Weight g (1 pce)
<b>Feed-through</b>				
Grey	<b>ZS6</b>	<b>1SNK 506 010 R0000</b>	50	10.64
Blue	<b>ZS6-BL</b>	<b>1SNK 506 020 R0000</b>	50	10.64
Orange	<b>ZS6-OR</b>	<b>1SNK 506 030 R0000</b>	50	10.64
Yellow	<b>ZS6-YL</b>	<b>1SNK 506 060 R0000</b>	50	10.64
Green	<b>ZS6-GN</b>	<b>1SNK 506 061 R0000</b>	50	10.64
Red	<b>ZS6-RD</b>	<b>1SNK 506 062 R0000</b>	50	10.64
Purple	<b>ZS6-PR</b>	<b>1SNK 506 063 R0000</b>	50	10.64
Brown	<b>ZS6-BR</b>	<b>1SNK 506 064 R0000</b>	50	10.64
White	<b>ZS6-WH</b>	<b>1SNK 506 065 R0000</b>	50	10.64
Black	<b>ZS6-BK</b>	<b>1SNK 506 066 R0000</b>	50	10.64

#### ZS6 Terminal Block Accessories

1SNK 160 001 C0201

Description	Type	Order Code	Pack <sup>(n)</sup> pieces	Weight g (1 pce)
<b>1 End Stops</b>	10 mm 0.394 in Dark Grey	<b>BAM3</b>	<b>1SNK 900 001 R0000</b>	50 13.80
<b>2 End Sections</b>	2.2 mm 0.087 in Dark Grey	<b>ES4</b>	<b>1SNK 505 910 R0000</b>	20 2.18
<b>3 Jumper Bars</b>	2 poles 41 A 30 A Orange	<b>JB6-2</b>	<b>1SNK 906 302 R0000</b>	50 1.30
	3 poles	<b>JB6-3</b>	<b>1SNK 906 303 R0000</b>	50 2.10
	4 poles	<b>JB6-4</b>	<b>1SNK 906 304 R0000</b>	50 2.90
	5 poles	<b>JB6-5</b>	<b>1SNK 906 305 R0000</b>	50 3.60
	10 poles	<b>JB6-10</b>	<b>1SNK 906 310 R0000</b>	20 7.40
<b>4 Circuit Separators</b>	50 poles	<b>JB6-50</b>	<b>1SNK 906 350 R0000</b>	10 38.10
	0 mm 0 in Dark Grey	<b>CS</b>	<b>1SNK 900 101 R0000</b>	20 0.20
<b>5 Test Adapters</b>	3 mm 0.118 in	<b>CS-R1</b>	<b>1SNK 900 103 R0000</b>	20 5.20
	For test plugs DIA 2 mm 0.079 in Dark Grey	<b>TP2</b>	<b>1SNK 900 203 R0000</b>	20 1.73
<b>6 Test Connectors</b>	For test plugs DIA 4 mm 0.160 in	<b>TP4</b>	<b>1SNK 900 205 R0000</b>	20 2.42
	5.2 mm 0.205 in spacing Dark Grey	<b>TC5</b>	<b>1SNK 900 200 R0000</b>	10 5.23
<b>7 Spacers</b>	End module, 5.2 mm 0.205 in	<b>TC5-R1</b>	<b>1SNK 900 201 R0000</b>	10 5.23
	0.8 mm 0.031 in spacing Dark Grey	<b>ES-TC6</b>	<b>1SNK 900 105 R0000</b>	10 0.80
<b>8 Shield Connectors</b>		<b>SHBS</b>	<b>1SNK 900 600 R0000</b>	20 3.50
<b>9 Protecting Covers</b>	6 mm .236 in spacing Transparent	<b>PL6</b>	<b>1SNK 900 619 R0000</b>	20 1.84
<b>10 Terminal Block Markers</b>	Blank card White	<b>MC612</b>	<b>1SNK 150 000 R0000</b>	22 0.06
	Universal wire markers holder Grey	<b>UMH</b>	<b>1SNK 900 611 R0000</b>	10 0.20
	Self adhesive strip White	<b>SAT6</b>	<b>1SNK 900 615 R0000</b>	5 6.00

Some accessories may modify the terminal block's ratings. See complete information in "Technical Datasheet".



#### ZS6-PE Ground Screw Clamp Terminal Block

1SNK 161 015 S0201

1SNK 161 015 D0201

Description	Type	Order Code	Pack <sup>(n)</sup> pieces	Weight g (1 pce)
<b>Ground</b> Profile aligned with ZS6	Green-Yellow	<b>ZS6-PE</b>	<b>1SNK 506 150 R0000</b>	20 13.70

All the technical data for UL/CSA standard and dimensions in inches are in *italics*.



# ZS10 Screw Clamp Terminal Block Feed-through

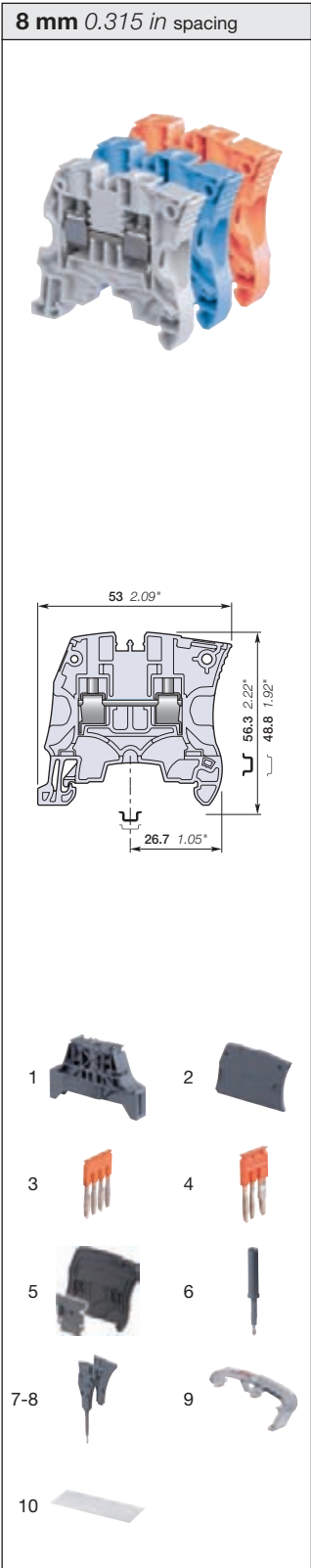

## Features and Benefits

Save space by connecting conductors up to 10 mm<sup>2</sup> (CB certified) 6 AWG in just 8 mm 0.315 in spacing.

## Main Technical Data

Connecting capacity		IEC	cULus - CSA
with 1 conductor per clamp	Rigid	0.5-10 mm <sup>2</sup>	20-6 AWG
	Flexible	0.5-10 mm <sup>2</sup>	20-6 AWG
	with ferrule	0.5-10 mm <sup>2</sup>	20-8 AWG
		Gauge	A5-B5
with 2 conductors per clamp	Rigid	0.5-2.5 mm <sup>2</sup>	20-14 AWG
	Flexible	0.5-2.5 mm <sup>2</sup>	20-14 AWG
	with twin ferrule	0.22-2.5 mm <sup>2</sup>	20-14 AWG
Rated cross section		10 mm <sup>2</sup>	6 AWG
Rated current		57 A	42 A
Rated short-time withstand current (1s)		1200 A	
Rated voltage		1000 V	600 V
Impulse withstand voltage		8000 V	
Protection		IP 20	NEMA 1

## Mounting Instructions

Rail		DIN3-TH35
Wire stripping length		12 mm 0.472 in
Tool		Flat screwdriver Ø 4 mm Ø 0.157 in
Torque		1.3 Nm ± 0.3 11.5 lb.in ± 2.65

Rated voltage Ex e 630 V (IEC/EN/cULUS 60079-7) IM2 II 2 GD Ex e I/II

															Gost, Br-Ex, and BV: Pending - 2009
--	--	--	--	--	--	--	--	--	--	--	--	--	--	--	-------------------------------------

## Ordering Details

### ZS10 Feed-through Screw Clamp Terminal Block

Description	Type	Order Code	Pack <sup>(ing)</sup> pieces	Weight g (1 pce)
<b>Feed-through</b>	Grey	<b>ZS10</b>	1SNK 508 010 R0000	50 14.10
	Blue	<b>ZS10-BL</b>	1SNK 508 020 R0000	50 14.10
	Orange	<b>ZS10-OR</b>	1SNK 508 030 R0000	50 14.10
	Yellow	<b>ZS10-YL</b>	1SNK 508 060 R0000	50 14.10
	Green	<b>ZS10-GN</b>	1SNK 508 061 R0000	50 14.10
	Red	<b>ZS10-RD</b>	1SNK 508 062 R0000	50 14.10
	Purple	<b>ZS10-PR</b>	1SNK 508 063 R0000	50 14.10
	Brown	<b>ZS10-BR</b>	1SNK 508 064 R0000	50 14.10
	White	<b>ZS10-WH</b>	1SNK 508 065 R0000	50 14.10
	Black	<b>ZS10-BK</b>	1SNK 508 066 R0000	50 14.10

### ZS10 Terminal Block Accessories

1SNK 160 001 C0201

Description	Type	Order Code	Pack <sup>(ing)</sup> pieces	Weight g (1 pce)	
1 <b>End Stops</b> 10 mm 0.394 in	Dark Grey	<b>BAM3</b>	1SNK 900 001 R0000	50 13.80	
2 <b>End Sections</b> 2.2 mm 0.087 in	Dark Grey	<b>ES4</b>	1SNK 505 910 R0000	20 2.18	
3 <b>Jumper Bars</b> 2 poles 57 A 42 A	Orange	<b>JB8-2</b>	1SNK 908 302 R0000	50 2.70	
		<b>JB8-3</b>	1SNK 908 303 R0000	50 4.10	
	3 poles		<b>JB8-4</b>	1SNK 908 304 R0000	50 5.60
	4 poles		<b>JB8-5</b>	1SNK 908 305 R0000	40 7.00
	5 poles		<b>JB8-10</b>	1SNK 908 310 R0000	20 14.20
10 poles					
4 <b>Cross Spacing Jumpers</b> 8 mm 0.315 in to 5.2 mm 0.205 in spacing	Orange	<b>JB85-3</b>	1SNK 900 603 R0000	10 2.80	
5 <b>Circuit Separators</b> 0 mm 0 in	Dark Grey	<b>CS</b>	1SNK 900 101 R0000	20 0.20	
		<b>CS-R1</b>	1SNK 900 103 R0000	20 5.20	
6 <b>Test Adapters</b> For test plugs DIA 2 mm 0.079 in	Dark Grey	<b>TP2</b>	1SNK 900 203 R0000	20 1.73	
		<b>TP4</b>	1SNK 900 205 R0000	20 2.42	
7 <b>Test Connectors</b> 5.2 mm 0.205 in spacing	Dark Grey	<b>TC5</b>	1SNK 900 200 R0000	10 5.23	
		<b>TC5-R1</b>	1SNK 900 201 R0000	10 5.23	
8 <b>Spacers</b> 2.8 mm 0.110 in spacing	Dark Grey	<b>ES-TC8</b>	1SNK 900 104 R0000	10 1.35	
9 <b>Protecting Covers</b> 8 mm .315 in spacing	Transparent	<b>PL8</b>	1SNK 900 620 R0000	20 2.55	
10 <b>Terminal Block Markers</b> Blank card	White	<b>MC812</b>	1SNK 160 000 R0000	22 0.09	
	Grey	<b>UMH</b>	1SNK 900 611 R0000	10 0.20	
	Self adhesive strip	White	<b>SAT8</b>	1SNK 900 616 R0000	5 6.00

Some accessories may modify the terminal block's ratings. See complete information in "Technical Datasheet".

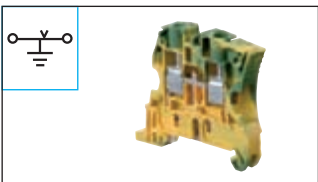

### ZS10-PE Ground Screw Clamp Terminal Block

1SNK 161 016 S0201

1SNK 161 016 D0201

Description	Type	Order Code	Pack <sup>(ing)</sup> pieces	Weight g (1 pce)
<b>Ground Profile aligned with ZS10</b>	Green-Yellow	<b>ZS10-PE</b>	1SNK 508 150 R0000	20 22.50

All the technical data for UL/CSA standard and dimensions in inches are in italic.



**16 mm<sup>2</sup>**  
**4 AWG**

# ZS16 Screw Clamp Terminal Block

## Feed-through

10 mm 0.394 in spacing

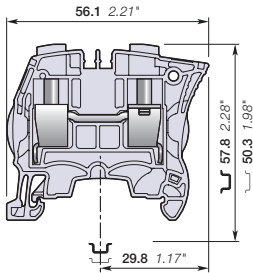
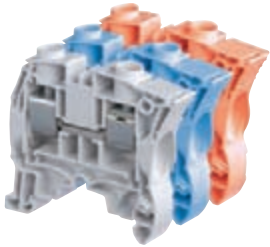

### Features and Benefits

Save space by connecting conductors up to 16 mm<sup>2</sup> (CB certified) 4 AWG in just 10 mm 0.394 in spacing.

### Main Technical Data

Connecting capacity	IEC	cULus - CSA
with 1 conductor per clamp	Rigid 0.5-16 mm <sup>2</sup>	20-4 AWG
	Flexible 0.5-16 mm <sup>2</sup>	20-4 AWG
	with ferrule 0.5-10 mm <sup>2</sup>	20-8 AWG
Gauge A6-B6		
with 2 conductors per clamp	Rigid 0.5-4 mm <sup>2</sup>	20-12 AWG
	Flexible 0.5-4 mm <sup>2</sup>	20-12 AWG
	with twin ferrule 0.5-4 mm <sup>2</sup>	20-12 AWG
Rated cross section	16 mm <sup>2</sup>	4 AWG
Rated current	76 A	67 A
Rated short-time withstand current (1s)	1920 A	
Rated voltage	1000 V	600 V
Impulse withstand voltage	8000 V	
Protection	IP 20	NEMA 1

### Mounting Instructions

Rail		DIN3-TH35
Wire stripping length		13.5 mm 0.531 in
Tool		Flat screwdriver Ø 5.5 mm Ø 0.217 in
Torque		2 Nm ± 0.4 17.7 lb.in ± 3.54

Rated voltage Ex e 630 V (IEC/EN/cULus 60079-7) IM2 II 2 GD Ex e I/II



Gost, Br-Ex, and BV: Pending - 2009

### Ordering Details

#### ZS16 Feed-through Screw Clamp Terminal Block

Description	Type	Order Code	Pack <sup>(n)</sup> pieces	Weight g (1 pce)
<b>Feed-through</b>	Grey <input type="checkbox"/>	<b>ZS16</b>	<b>1SNK 510 010 R0000</b>	25 20.20
	Blue <input type="checkbox"/>	<b>ZS16-BL</b>	<b>1SNK 510 020 R0000</b>	25 20.20
	Orange <input type="checkbox"/>	<b>ZS16-OR</b>	<b>1SNK 510 030 R0000</b>	25 20.20

#### ZS16 Terminal Block Accessories

1SNK 160 001 C0201

Description	Type	Order Code	Pack <sup>(n)</sup> pieces	Weight g (1 pce)
<b>1 End Stops</b>	10 mm 0.394 in Dark Grey <input type="checkbox"/>	<b>BAM3</b>	<b>1SNK 900 001 R0000</b>	50 13.80
<b>2 End Sections</b>	2.2 mm 0.087 in Dark Grey <input type="checkbox"/>	<b>ES4</b>	<b>1SNK 505 910 R0000</b>	20 2.18
<b>3 Jumper Bars</b>	2 poles 76 A 67 A Orange <input type="checkbox"/>	<b>JB10-2</b>	<b>1SNK 910 302 R0000</b>	50 4.60
	3 poles	<b>JB10-3</b>	<b>1SNK 910 303 R0000</b>	50 7.10
	4 poles	<b>JB10-4</b>	<b>1SNK 910 304 R0000</b>	40 9.40
	5 poles	<b>JB10-5</b>	<b>1SNK 910 305 R0000</b>	30 12.00
	10 poles	<b>JB10-10</b>	<b>1SNK 910 310 R0000</b>	20 24.00
<b>4 Circuit Separators</b>	0 mm 0 in Dark Grey <input type="checkbox"/>	<b>CS</b>	<b>1SNK 900 101 R0000</b>	20 0.20
	3 mm 0.118 in	<b>CS-R1</b>	<b>1SNK 900 103 R0000</b>	20 5.20
<b>5 Test Adapters</b>	For test plugs DIA 2 mm 0.079 in Dark Grey <input type="checkbox"/>	<b>TP2</b>	<b>1SNK 900 203 R0000</b>	20 1.73
	For test plugs DIA 4 mm 0.160 in	<b>TP4</b>	<b>1SNK 900 205 R0000</b>	20 2.42
<b>6 Protecting Covers</b>	Transparent <input type="checkbox"/>	<b>PL10</b>	<b>1SNK 900 621 R0000</b>	10 3.13
<b>7 Terminal Block Markers</b>	Blank card White <input type="checkbox"/>	<b>MC812</b>	<b>1SNK 160 000 R0000</b>	22 0.09
	Universal wire markers holder Grey <input type="checkbox"/>	<b>UMH</b>	<b>1SNK 900 611 R0000</b>	10 0.20
	Self adhesive strip White <input type="checkbox"/>	<b>SAT8</b>	<b>1SNK 900 616 R0000</b>	5 6.00

Some accessories may modify the terminal block's ratings. See complete information in "Technical Datasheet".



#### ZS16-PE Ground Screw Clamp Terminal Block

1SNK 161 018 S0201

1SNK 161 018 D0201

Description	Type	Order Code	Pack <sup>(n)</sup> pieces	Weight g (1 pce)
<b>Ground Profile aligned with ZS16</b>	Green-Yellow <input type="checkbox"/>	<b>ZS16-PE</b>	<b>1SNK 510 150 R0000</b>	20 32.00

All the technical data for UL/CSA standard and dimensions in inches are in *italics*.

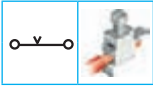

**35 mm<sup>2</sup>**  
**0 AWG**

# ZS35 Screw Clamp Terminal Block

## Feed-through

16 mm 0.630 in spacing

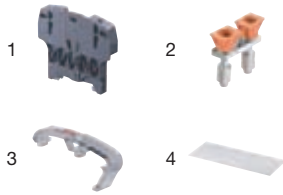
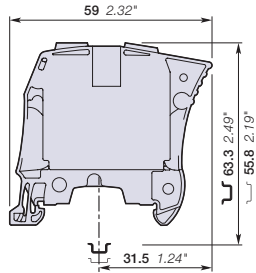

### Features and Benefits

Closed terminal block:  
- No end section needed,  
- Optimized rigidity.

### Main Technical Data

Connecting capacity		IEC	cULus - CSA
with 1 conductor per clamp	Rigid	6-35 mm <sup>2</sup>	10-0 AWG
	Flexible	6-35 mm <sup>2</sup>	10-0 AWG
	with ferrule		
		Gauge	A9-B9
with 2 conductors per clamp	Rigid	16 mm <sup>2</sup>	4 AWG
	Flexible	10 mm <sup>2</sup>	6 AWG
	with twin ferrule		
Rated cross section		35 mm <sup>2</sup>	0 AWG
Rated current		125 A	150 A
Rated short-time withstand current (1s)		4200 A	
Rated voltage		1000 V	600 V
Impulse withstand voltage		8000 V	
Protection		IP 20	NEMA 1

### Mounting Instructions

Rail		DIN3-TH35
Wire stripping length		17 mm 0.669 in
Tool		Flat screwdriver Ø 6.5 mm Ø 0.256 in
Torque		2.9 Nm ± 0.1 25.7 lb.in ± 0.885

Rated voltage Ex e 630 V (IEC/EN/cULus 60079-7) IM2 II 2 GD Ex e I/II



### Ordering Details

#### ZS35 Feed-through Screw Clamp Terminal Block

Description	Type	Order Code	Pack <sup>(ing)</sup> pieces	Weight g (1 pce)
Feed-through Closed block	Grey <input type="checkbox"/>	<b>ZS35</b>	<b>1SNK 516 010 R0000</b>	20 53.40
	Blue <input type="checkbox"/>	<b>ZS35-BL</b>	<b>1SNK 516 020 R0000</b>	20 53.40
	Orange <input type="checkbox"/>	<b>ZS35-OR</b>	<b>1SNK 516 030 R0000</b>	20 53.40

#### ZS35 Terminal Block Accessories

1SNK 160 001 C0201

Description	Type	Order Code	Pack <sup>(ing)</sup> pieces	Weight g (1 pce)	
1 End Stops 10 mm 0.394 in Dark Grey	<input checked="" type="checkbox"/>	<b>BAZH1</b>	<b>1SNK 900 102 R0000</b>	20 23.90	
2 Jumper Bars 2 poles 110 A 150 A Orange	<input checked="" type="checkbox"/>	<b>JB16-2</b>	<b>1SNK 916 302 R0000</b>	10 10.20	
	<input checked="" type="checkbox"/>	<b>JB16-3</b>	<b>1SNK 916 303 R0000</b>	10 16.00	
	<input checked="" type="checkbox"/>	<b>JB16-4</b>	<b>1SNK 916 304 R0000</b>	10 21.80	
	<input checked="" type="checkbox"/>	<b>JB16-5</b>	<b>1SNK 916 305 R0000</b>	10 27.60	
	<input checked="" type="checkbox"/>	<b>JB16-10</b>	<b>1SNK 916 310 R0000</b>	10 56.60	
3 Protecting Covers 16 mm 0.630 in spacing Transparent	<input checked="" type="checkbox"/>	<b>PL16</b>	<b>1SNK 900 622 R0000</b>	10 4.60	
4 Terminal Block Markers	Blank card White	<input type="checkbox"/>	<b>MC812</b>	<b>1SNK 160 000 R0000</b>	22 0.09
	Universal wire markers holder Grey	<input type="checkbox"/>	<b>UMH</b>	<b>1SNK 900 611 R0000</b>	10 0.20
	Self adhesive strip White	<input type="checkbox"/>	<b>SAT8</b>	<b>1SNK 900 616 R0000</b>	5 6.00

Some accessories may modify the terminal block's ratings. See complete information in "Technical Datasheet".

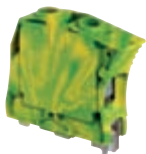

#### ZS35-PE Ground Screw Clamp Terminal Block

1SNK 161 020 S0201

1SNK 161 020 D0201

Description	Type	Order Code	Pack <sup>(ing)</sup> pieces	Weight g (1 pce)
Ground Profile aligned with ZS35	Green-Yellow <input checked="" type="checkbox"/>	<b>ZS35-PE</b>	<b>1SNK 516 150 R0000</b>	20 81.80

All the technical data for UL/CSA standard and dimensions in inches are in *italics*.



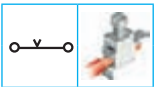

**70 mm<sup>2</sup>**  
**00 AWG**

# ZS70 Screw Clamp Terminal Block

## Feed-through

22 mm 0.866 in spacing

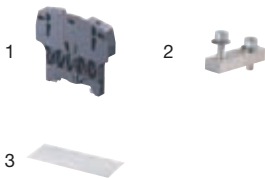
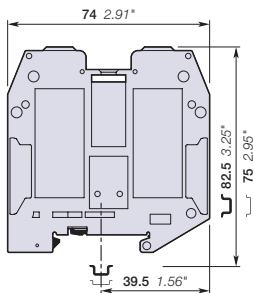

### Features and Benefits

- Closed terminal block:
- No end section needed,
  - Optimized rigidity.

### Main Technical Data

Connecting capacity	IEC	cULus - CSA
with 1 conductor per clamp	Rigid	16-95 mm <sup>2</sup>
	Flexible	16-70 mm <sup>2</sup>
	with ferrule	
		Gauge B11
with 2 conductors per clamp	Rigid	25-35 mm <sup>2</sup>
	Flexible	25-35 mm <sup>2</sup>
	with twin ferrule	
Rated cross section	70 mm <sup>2</sup>	00 AWG
Rated current	192 A	175 A
Rated short-time withstand current (1s)	8400 A	
Rated voltage	1000 V	600 V
Impulse withstand voltage	8000 V	
Protection	IP 10	NEMA 1

### Mounting Instructions

Rail		DIN3-TH35
Wire stripping length		25 mm 0.984 in
Tool		Allen Key Ø 6 mm Ø 0.236 in
Torque		6.5 Nm ± 0.5 57.5 lb.in ± 4.4

Rated voltage Ex e 630 V (IEC/EN/cULus 60079-7) IM2 II 2 GD Ex e I/II



Gost, Br-Ex, and BV: Pending - 2009

### Ordering Details

#### ZS70 Feed-through Screw Clamp Terminal Block

Description	Type	Order Code	Pack <sup>(n)</sup> pieces	Weight g (1 pce)
Feed-through Closed block	Grey	<b>ZS70</b>	1SNK 522 010 R0000	10 158.10
	Blue	<b>ZS70-BL</b>	1SNK 522 020 R0000	10 158.10

#### ZS70 Terminal Block Accessories

1SNK 160 001 C0201

Description	Type	Order Code	Pack <sup>(n)</sup> pieces	Weight g (1 pce)
1 End Stops	10 mm 0.394 in Dark Grey	<b>BAZH1</b>	1SNK 900 102 R0000	20 23.90
2 Jumper Bars	2 poles 192 A 175 A	<b>JB22-2</b>	1SNK 922 302 R0000	5 27.00
	3 poles	<b>JB22-3</b>	1SNK 922 303 R0000	5 43.30
	5 poles	<b>JB22-5</b>	1SNK 922 305 R0000	5 76.10
	10 poles	<b>JB22-10</b>	1SNK 922 310 R0000	5 157.40
3 Terminal Block Markers	Blank card White	<b>MC812</b>	1SNK 160 000 R0000	22 0.09
	Universal wire markers holder Grey	<b>UMH</b>	1SNK 900 611 R0000	10 0.20
	Self adhesive strip White	<b>SAT8</b>	1SNK 900 616 R0000	5 6.00

Some accessories may modify the terminal block's ratings. See complete information in "Technical Datasheet".



#### ZS70-PE Ground Screw Clamp Terminal Block

1SNK 161 022 S0201

1SNK 161 022 D0201

Description	Type	Order Code	Pack <sup>(n)</sup> pieces	Weight g (1 pce)
Ground Profile aligned with ZS70	Green-Yellow	<b>ZS70-PE</b>	1SNK 522 150 R0000	10 222.00

All the technical data for UL/CSA standard and dimensions in inches are in *italics*.

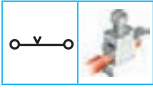

**95 mm<sup>2</sup>**  
**000 AWG**

# ZS95 Screw Clamp Terminal Block

## Feed-through

26 mm 1.023 in spacing

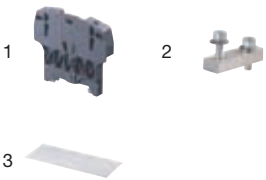
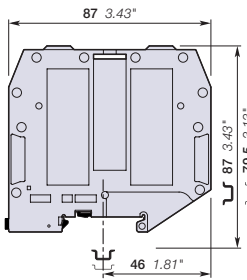

### Features and Benefits

- Closed terminal block:
- No end section needed,
  - Optimized rigidity.

### Main Technical Data

Connecting capacity	IEC	cULus - CSA
with 1 conductor per clamp	Rigid	35-120 mm <sup>2</sup>
	Flexible	35-95 mm <sup>2</sup>
	with ferrule	
	Gauge	B12
with 2 conductors per clamp	Rigid	
	Flexible	
	with twin ferrule	
Rated cross section	95 mm <sup>2</sup>	000 AWG
Rated current	232 A	230 A
Rated short-time withstand current (1s)	11400 A	
Rated voltage	1000 V	600 V
Impulse withstand voltage	8000 V	
Protection	IP 10	NEMA 1

### Mounting Instructions

Rail		DIN3-TH35
Wire stripping length		26 mm 1.023 in
Tool		Allen Key Ø 6 mm Ø 0.236 in
Torque		9.25 Nm ± 0.25 81.7 lb.in ± 2.2

Rated voltage Ex e 630 V (IEC/EN/cULus 60079-7) IM2 II 2 GD Ex e I/II



Gost, Br-Ex, and BV: Pending - 2009

### Ordering Details

#### ZS95 Feed-through Screw Clamp Terminal Block

Description	Type	Order Code	Pack <sup>(ing)</sup> pieces	Weight g (1 pce)
Feed-through Closed block	Grey	<b>ZS95</b>	<b>1SNK 526 010 R0000</b>	10 215.10
	Blue	<b>ZS95-BL</b>	<b>1SNK 526 020 R0000</b>	10 215.10

#### ZS95 Terminal Block Accessories

1SNK 160 001 C0201

Description	Type	Order Code	Pack <sup>(ing)</sup> pieces	Weight g (1 pce)	
1 End Stops	10 mm 0.394 in Dark Grey	<b>BAZH1</b>	<b>1SNK 900 102 R0000</b>	20 23.90	
2 Jumper Bars	2 poles 232 A 230 A	<b>JB26-2</b>	<b>1SNK 926 302 R0000</b>	5 41.20	
	3 poles	<b>JB26-3</b>	<b>1SNK 926 303 R0000</b>	5 65.70	
	5 poles	<b>JB26-5</b>	<b>1SNK 926 305 R0000</b>	5 115.70	
	10 poles	<b>JB26-10</b>	<b>1SNK 926 310 R0000</b>	5 241.50	
3 Terminal Block Markers	Blank card	White	<b>MC812</b>	<b>1SNK 160 000 R0000</b>	22 0.09
	Universal wire markers holder	Grey	<b>UMH</b>	<b>1SNK 900 611 R0000</b>	10 0.20
	Self adhesive strip	White	<b>SAT8</b>	<b>1SNK 900 616 R0000</b>	5 6.00

Some accessories may modify the terminal block's ratings. See complete information in "Technical Datasheet".



#### ZS95-PE Ground Screw Clamp Terminal Block

1SNK 161 024 S0201

1SNK 161 024 D0201

Description	Type	Order Code	Pack <sup>(ing)</sup> pieces	Weight g (1 pce)
Ground Profile aligned with ZS95	Green-Yellow	<b>ZS95-PE</b>	<b>1SNK 526 150 R0000</b>	10 278.00

All the technical data for UL/CSA standard and dimensions in inches are in italic.

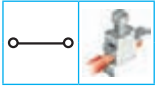

4 mm<sup>2</sup>  
10 AWG

## ZS4-R1 Screw Clamp Terminal Block

### Feed-through

8 mm 0.315 in spacing

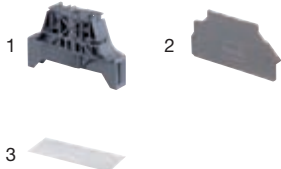
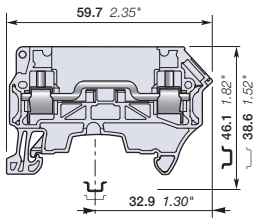

### Features and Benefits

Simplify the alternated feed-through and fuse circuits operations:

- With the same profile as the ZS4-SF1, the wiring of the alternated feed-through and fuse circuits is easier.

### Main Technical Data

Connecting capacity	IEC	cULus - CSA
with 1 conductor per clamp	Rigid 0.2-4 mm <sup>2</sup>	24-10 AWG
	Flexible 0.22-4 mm <sup>2</sup>	24-10 AWG
	with ferrule 0.22-4 mm <sup>2</sup>	24-12 AWG
	Gauge A3-B3	
with 2 conductors per clamp	Rigid 0.2-1 mm <sup>2</sup>	24-18 AWG
	Flexible 0.22-1 mm <sup>2</sup>	24-18 AWG
	with twin ferrule 0.22-1.5 mm <sup>2</sup>	24-16 AWG
Maximum cross section	4 mm <sup>2</sup>	10 AWG
Max. current / Max. cross section	28 A	26 A
Maximum short circuit current (1s)	480 A	
Rated voltage	800 V	300 V
Impulse withstand voltage	8000 V	
Protection	IP 20	NEMA 1

### Mounting Instructions

Rail		DIN3-TH35
Wire stripping length		11 mm 0.433 in
Tool		Flat screwdriver Ø 3.5 mm Ø 0.138 in
Torque		0.6 Nm ± 0.1 5.31 lb.in ± 0.885



Gost and BV: Pending - 2009

### Ordering Details

#### ZS4-R1 Feed-through Screw Clamp Terminal Block

Description	Type	Order Code	Pack <sup>(n)</sup> pieces	Weight g (1 pce)
<b>Feed-through</b>	Profile aligned with ZS4-SF1 Grey <input type="checkbox"/>	<b>ZS4-R1</b>	<b>1SNK 508 013 R0000</b>	50 11.00

#### ZS4-R1 Terminal Block Accessories

1SNK 160 001 C0201

Description	Type	Order Code	Pack <sup>(n)</sup> pieces	Weight g (1 pce)
1 <b>End Stops</b>	10 mm 0.394 in Dark Grey <input checked="" type="checkbox"/>	<b>BAM3</b>	<b>1SNK 900 001 R0000</b>	50 13.80
2 <b>End Sections</b>	1.5 mm 0.059 in Dark Grey <input checked="" type="checkbox"/>	<b>ES4-SF</b>	<b>1SNK 508 960 R0000</b>	20 1.82
3 <b>Terminal Block</b>	Blank card White <input type="checkbox"/>	<b>MC812</b>	<b>1SNK 160 000 R0000</b>	22 0.09
<b>Markers</b>	Universal wire markers holder Grey <input type="checkbox"/>	<b>UMH</b>	<b>1SNK 900 611 R0000</b>	10 0.20
	Self adhesive strip White <input type="checkbox"/>	<b>SAT8</b>	<b>1SNK 900 616 R0000</b>	5 6.00

Some accessories may modify the terminal block's ratings. See complete information in "Technical Datasheet".



#### ZS4-SF1 Fuse Screw Clamp Terminal Block

1SNK 161 011 S0201

1SNK 161 011 D0201

Description	Type	Order Code	Pack <sup>(n)</sup> pieces	Weight g (1 pce)
<b>Fuse</b>	Grey-Dark Grey <input checked="" type="checkbox"/>	<b>ZS4-SF1</b>	<b>1SNK 508 410 R0000</b>	50 13.30

All the technical data for UL/CSA standard and dimensions in inches are in *italics*.



**4 mm<sup>2</sup>**  
**12 AWG**

# ZS4-D2 Screw Clamp Terminal Block

## Double deck with 2 feed-through circuits

5.2 mm 0.205 in spacing

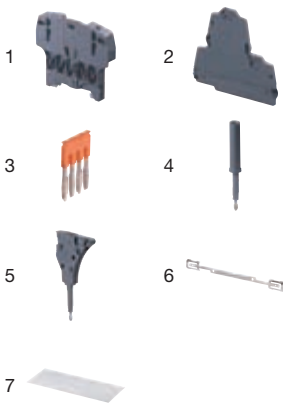
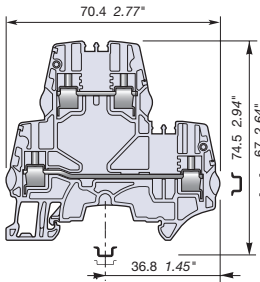

### Features and Benefits

Save space:

- High wiring density on two decks,
- Connection of conductors up to 4 mm<sup>2</sup> (CB certified) 12 AWG in just 5.2 mm 0.205 in spacing.

### Main Technical Data

Connecting capacity	IEC	cULus - CSA
with 1 conductor per clamp	Rigid 0.2-4 mm <sup>2</sup>	24-10 AWG
	Flexible 0.22-4 mm <sup>2</sup>	24-12 AWG
	with ferrule 0.22-4 mm <sup>2</sup>	24-12 AWG
	Gauge A3-B3	
with 2 conductors per clamp	Rigid 0.2-1 mm <sup>2</sup>	24-18 AWG
	Flexible 0.22-1 mm <sup>2</sup>	24-18 AWG
	with twin ferrule 0.22-1.5 mm <sup>2</sup>	22-16 AWG
Rated cross section	4 mm <sup>2</sup>	12 AWG
Rated current	29 A	20 A
Rated short-time withstand current (1s)	480 A	
Rated voltage	800 V	300 V
Impulse withstand voltage	8000 V	
Protection	IP 20	NEMA 1

### Mounting Instructions

Rail		DIN3-TH35
Wire stripping length		10 mm 0.394 in
Tool		Flat screwdriver Ø 3.5 mm Ø 0.138 in
Torque		0.6 Nm ± 0.1 5.31 lb.in ± 0.885

Rated voltage Ex e 400 V (IEC/EN/cULus 60079-7) IM2 II 2 GD Ex e I/II



Gost, Br-Ex, and BV: Pending - 2009

### Ordering Details

#### ZS4-D2 Double deck Screw Clamp Terminal Block

Description	Type	Order Code	Pack <sup>(1ng)</sup> pieces	Weight g (1 pce)
Double deck 2 Feed-through Circuits	Grey	<b>ZS4-D2</b>	<b>1SNK 505 210 R0000</b>	50 15.25
	Blue	<b>ZS4-D2-BL</b>	<b>1SNK 505 220 R0000</b>	50 15.25
	Orange	<b>ZS4-D2-OR</b>	<b>1SNK 505 230 R0000</b>	50 15.25

#### ZS4-D2 Terminal Block Accessories

1SNK 160 001 C0201

Description	Type	Order Code	Pack <sup>(1ng)</sup> pieces	Weight g (1 pce)
1 <b>End Stops</b> 10 mm 0.394 in	Dark Grey	<b>BAZH1</b>	<b>1SNK 900 102 R0000</b>	20 23.90
2 <b>End Sections</b> 2.55 mm 0.100 in	Dark Grey	<b>ES4-D2</b>	<b>1SNK 505 960 R0000</b>	20 4.10
3 <b>Jumper Bars</b> 2 poles 32 A 30 A	Orange	<b>JB5-2</b>	<b>1SNK 905 302 R0000</b>	50 1.30
		<b>JB5-3</b>	<b>1SNK 905 303 R0000</b>	50 2.00
		<b>JB5-4</b>	<b>1SNK 905 304 R0000</b>	50 2.70
		<b>JB5-5</b>	<b>1SNK 905 305 R0000</b>	50 3.50
4 <b>Test Adapters</b> For test plugs DIA 2 mm 0.079 in	Dark Grey	<b>JB5-10</b>	<b>1SNK 905 310 R0000</b>	30 7.10
		<b>TP2</b>	<b>1SNK 900 203 R0000</b>	20 1.73
	For test plugs DIA 4 mm 0.160 in		<b>TP4</b>	<b>1SNK 900 205 R0000</b>
5 <b>Test Connectors</b> 5.2 mm 0.205 in spacing	Dark Grey	<b>TC5</b>	<b>1SNK 900 200 R0000</b>	10 5.23
	End module, 5.2 mm 0.205 in		<b>TC5-R1</b>	<b>1SNK 900 201 R0000</b>
6 <b>Shield Connectors</b>		<b>SHB</b>	<b>1SNK 900 602 R0000</b>	20 4.90
7 <b>Terminal Block Markers</b> Blank card	White	<b>MC512</b>	<b>1SNK 140 000 R0000</b>	22 0.06
	Grey	<b>UMH</b>	<b>1SNK 900 611 R0000</b>	10 0.20
	Self adhesive strip	White	<b>SAT5</b>	<b>1SNK 900 614 R0000</b>

Some accessories may modify the terminal block's ratings. See complete information in "Technical Datasheet".



4 mm<sup>2</sup>  
12 AWG

# ZS4-D1 Screw Clamp Terminal Block

Double deck with 1 feed-through circuit

5.2 mm 0.205 in spacing

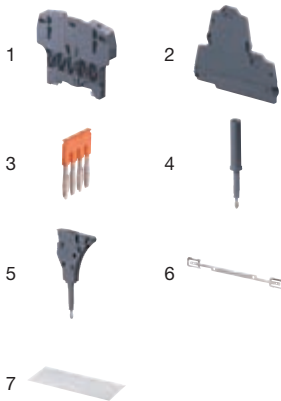
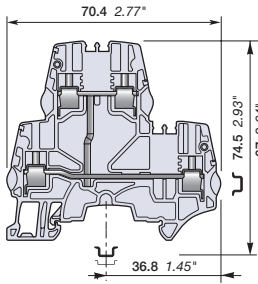

## Features and Benefits

- Ease one potential distribution on 4 independent screw clamps,
- Save space by connecting conductors up to 4 mm<sup>2</sup> (CB certified) 12 AWG in just 5.2 mm 0.205 in spacing.

## Main Technical Data

Connecting capacity	IEC	cULus - CSA
with 1 conductor per clamp	Rigid 0.2-4 mm <sup>2</sup>	24-10 AWG
	Flexible 0.22-4 mm <sup>2</sup>	24-12 AWG
	with ferrule 0.22-4 mm <sup>2</sup>	24-12 AWG
	Gauge A3-B3	
with 2 conductors per clamp	Rigid 0.2-1 mm <sup>2</sup>	24-18 AWG
	Flexible 0.22-1 mm <sup>2</sup>	24-18 AWG
	with twin ferrule 0.22-1.5 mm <sup>2</sup>	22-16 AWG
Rated cross section	4 mm <sup>2</sup>	12 AWG
Rated current	29 A	20 A
Rated short-time withstand current (1s)	480 A	
Rated voltage	800 V	300 V
Impulse withstand voltage	8000 V	
Protection	IP 20	NEMA 1

## Mounting Instructions

Rail		DIN3-TH35
Wire stripping length		10 mm 0.394 in
Tool		Flat screwdriver Ø 3.5 mm Ø 0.138 in
Torque		0.6 Nm ± 0.1 5.31 lb.in ± 0.885

Rated voltage Ex e 400 V (IEC/EN/cULus 60079-7) IM2 II 2 GD Ex e I/II

CE	CB	RoHS	cULus	CSA	Gost	ATEX	IECEE	br-Ex	BV								Gost, Br-Ex, and BV: Pending - 2009
----	----	------	-------	-----	------	------	-------	-------	----	--	--	--	--	--	--	--	-------------------------------------

## Ordering Details

### ZS4-D1 Double deck Screw Clamp Terminal Block

Description	Type	Order Code	Pack <sup>(n)</sup> pieces	Weight g (1 pce)
<b>Double deck</b> 1 Feed-through Circuit	Grey <input type="checkbox"/>	<b>ZS4-D1</b>	<b>1SNK 505 211 R0000</b>	50 15.25

## ZS4-D1 Terminal Block Accessories

1SNK 160 001 C0201

Description	Type	Order Code	Pack <sup>(n)</sup> pieces	Weight g (1 pce)
<b>1 End Stops</b> 10 mm 0.394 in Dark Grey <input type="checkbox"/>	<b>BAZH1</b>	<b>1SNK 900 102 R0000</b>	20	23.90
<b>2 End Sections</b> 2.55 mm 0.100 in Dark Grey <input type="checkbox"/>	<b>ES4-D2</b>	<b>1SNK 505 960 R0000</b>	20	4.10
<b>3 Jumper Bars</b> 2 poles 32 A 30 A Orange <input type="checkbox"/>	<b>JB5-2</b>	<b>1SNK 905 302 R0000</b>	50	1.30
	<b>JB5-3</b>	<b>1SNK 905 303 R0000</b>	50	2.00
	<b>JB5-4</b>	<b>1SNK 905 304 R0000</b>	50	2.70
	<b>JB5-5</b>	<b>1SNK 905 305 R0000</b>	50	3.50
	<b>JB5-10</b>	<b>1SNK 905 310 R0000</b>	30	7.10
<b>4 Test Adapters</b> For test plugs DIA 2 mm 0.079 in Dark Grey <input type="checkbox"/> For test plugs DIA 4 mm 0.160 in	<b>TP2</b>	<b>1SNK 900 203 R0000</b>	20	1.73
	<b>TP4</b>	<b>1SNK 900 205 R0000</b>	20	2.42
<b>5 Test Connectors</b> 5.2 mm 0.205 in spacing Dark Grey <input type="checkbox"/> End module, 5.2 mm 0.205 in	<b>TC5</b>	<b>1SNK 900 200 R0000</b>	10	5.23
	<b>TC5-R1</b>	<b>1SNK 900 201 R0000</b>	10	5.23
<b>6 Shield Connectors</b>	<b>SHB</b>	<b>1SNK 900 602 R0000</b>	20	4.90
<b>7 Terminal Block Markers</b>	Blank card White <input type="checkbox"/>	<b>MC512</b>	<b>1SNK 140 000 R0000</b>	22 0.06
	Universal wire markers holder Grey <input type="checkbox"/>	<b>UMH</b>	<b>1SNK 900 611 R0000</b>	10 0.20
	Self adhesive strip White <input type="checkbox"/>	<b>SAT5</b>	<b>1SNK 900 614 R0000</b>	5 6.00

Some accessories may modify the terminal block's ratings. See complete information in "Technical Datasheet".



**6 mm<sup>2</sup>**  
**10 AWG**

# ZS6-D2 Screw Clamp Terminal Block

## Double deck with 2 feed-through circuits

6 mm 0.236 in spacing

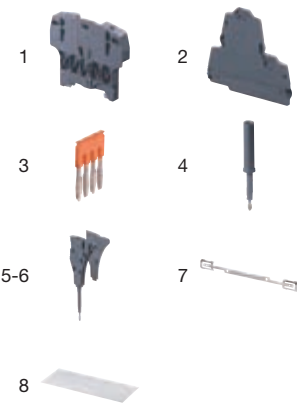
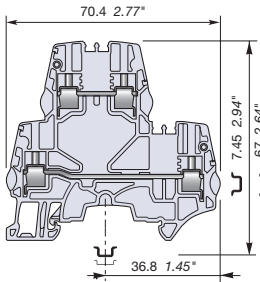

### Features and Benefits

Save space:

- High wiring density on two decks,
- Connection of conductors up to 6 mm<sup>2</sup> 10 AWG in just 6 mm 0.236 in spacing.

### Main Technical Data

Connecting capacity	IEC	cULus - CSA
with 1 conductor per clamp	Rigid 0.2-4 mm <sup>2</sup>	24-10 AWG
	Flexible 0.22-4 mm <sup>2</sup>	24-10 AWG
	with ferrule 0.22-4 mm <sup>2</sup>	24-10 AWG
	Gauge A4-B3	
with 2 conductors per clamp	Rigid 0.2-1.5 mm <sup>2</sup>	24-16 AWG
	Flexible 0.22-1.5 mm <sup>2</sup>	24-16 AWG
	with twin ferrule 0.22-1.5 mm <sup>2</sup>	24-16 AWG
Maximum cross section	6 mm <sup>2</sup>	10 AWG
Max. current / Max. cross section	41 A	30 A
Maximum short circuit current (1s)	720 A	
Rated voltage	800 V	300 V
Impulse withstand voltage	8000 V	
Protection	IP 20	NEMA 1

### Mounting Instructions

Rail		DIN3-TH35
Wire stripping length		10 mm 0.394 in
Tool		Flat screwdriver Ø 4 mm Ø 0.157 in
Torque		0.85 Nm ± 0.15 7.52 lb.in ± 1.33

Rated voltage Ex e 400 V (IEC/EN/cULus 60079-7) IM2 II 2 GD Ex e I/II



Gost, Br-Ex, and BV: Pending - 2009

### Ordering Details

#### ZS6-D2 Double deck Screw Clamp Terminal Block

Description	Type	Order Code	Pack <sup>(ing)</sup> pieces	Weight g (1 pce)
Double deck 2 Feed-through Circuits	Grey	<b>ZS6-D2</b>	<b>1SNK 506 210 R0000</b>	50 18.41
	Blue	<b>ZS6-D2-BL</b>	<b>1SNK 506 220 R0000</b>	50 18.41
	Orange	<b>ZS6-D2-OR</b>	<b>1SNK 506 230 R0000</b>	50 18.41

#### ZS6-D2 Terminal Block Accessories

1SNK 160 001 C0201

Description	Type	Order Code	Pack <sup>(ing)</sup> pieces	Weight g (1 pce)	
1 <b>End Stops</b> 10 mm 0.394 in	Dark Grey	<b>BAZH1</b>	<b>1SNK 900 102 R0000</b>	20 23.90	
2 <b>End Sections</b> 2.55 mm 0.100 in	Dark Grey	<b>ES4-D2</b>	<b>1SNK 505 960 R0000</b>	20 4.10	
3 <b>Jumper Bars</b> 2 poles 41 A 30 A	Orange	<b>JB6-2</b>	<b>1SNK 906 302 R0000</b>	50 1.30	
		<b>JB6-3</b>	<b>1SNK 906 303 R0000</b>	50 2.10	
		<b>JB6-4</b>	<b>1SNK 906 304 R0000</b>	50 2.90	
		<b>JB6-5</b>	<b>1SNK 906 305 R0000</b>	50 3.60	
4 <b>Test Adapters</b> For test plugs DIA 2 mm 0.079 in	Dark Grey	<b>JB6-10</b>	<b>1SNK 906 310 R0000</b>	20 7.40	
		<b>TP2</b>	<b>1SNK 900 203 R0000</b>	20 1.73	
	For test plugs DIA 4 mm 0.160 in		<b>TP4</b>	<b>1SNK 900 205 R0000</b>	20 2.42
5 <b>Test Connectors</b> 5.2 mm 0.205 in spacing	Dark Grey	<b>TC5</b>	<b>1SNK 900 200 R0000</b>	10 5.23	
	End module, 5.2 mm 0.205 in		<b>TC5-R1</b>	<b>1SNK 900 201 R0000</b>	10 5.23
6 <b>Spacers</b> 0.8 mm 0.031 in spacing	Dark Grey	<b>ES-TC6</b>	<b>1SNK 900 105 R0000</b>	10 0.80	
7 <b>Shield Connectors</b>		<b>SHB</b>	<b>1SNK 900 602 R0000</b>	20 4.90	
8 <b>Terminal Block Markers</b>	Blank card	White	<b>MC612</b>	<b>1SNK 150 000 R0000</b>	22 0.06
	Universal wire markers holder	Grey	<b>UMH</b>	<b>1SNK 900 611 R0000</b>	10 0.20
	Self adhesive strip	White	<b>SAT6</b>	<b>1SNK 900 615 R0000</b>	5 6.00

Some accessories may modify the terminal block's ratings. See complete information in "Technical Datasheet".



**6 mm<sup>2</sup>**  
**10 AWG**

# ZS6-D1 Screw Clamp Terminal Block

Double deck with 1 feed-through circuit

6 mm 0.236 in spacing

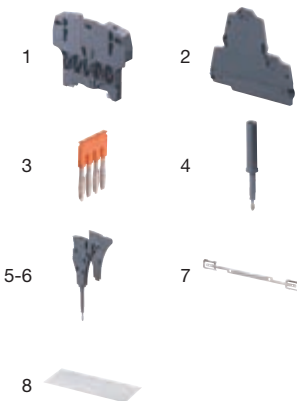
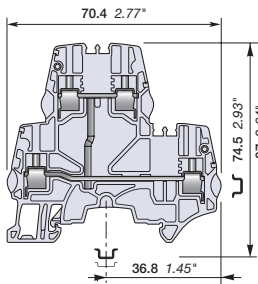

## Features and Benefits

- Ease one potential distribution on 4 independent screw clamps,
- Save space by connecting conductors up to 6 mm<sup>2</sup> 10 AWG in just 6 mm 0.236 in spacing.

## Main Technical Data

Connecting capacity	IEC	cULus - CSA
with 1 conductor per clamp	Rigid 0.2-4 mm <sup>2</sup>	24-10 AWG
	Flexible 0.22-4 mm <sup>2</sup>	24-10 AWG
	with ferrule 0.22-4 mm <sup>2</sup>	24-10 AWG
	Gauge A4-B3	
with 2 conductors per clamp	Rigid 0.2-1.5 mm <sup>2</sup>	24-16 AWG
	Flexible 0.22-1.5 mm <sup>2</sup>	24-16 AWG
	with twin ferrule 0.22-1.5 mm <sup>2</sup>	24-16 AWG
Maximum cross section	6 mm <sup>2</sup>	10 AWG
Max. current / Max. cross section	41 A	30 A
Maximum short circuit current (1s)	720 A	
Rated voltage	800 V	300 V
Impulse withstand voltage	8000 V	
Protection	IP 20	NEMA 1

## Mounting Instructions

Rail		DIN3-TH35
Wire stripping length		10 mm 0.394 in
Tool		Flat screwdriver Ø 4 mm Ø 0.157 in
Torque		0.85 Nm ± 0.15 7.52 lb.in ± 1.33

Rated voltage Ex e 400 V (IEC/EN/cULus 60079-7) IM2 II 2 GD Ex e I/II



Gost, Br-Ex, and BV: Pending - 2009

## Ordering Details

### ZS6-D1 Double deck Screw Clamp Terminal Block

Description	Type	Order Code	Pack <sup>(n)</sup> pieces	Weight g (1 pce)
<b>Double deck</b> 1 Feed-through Circuit	Grey	<b>ZS6-D1</b>	<b>1SNK 506 211 R0000</b>	50 18.41

## ZS6-D1 Terminal Block Accessories

1SNK 160 001 C0201

Description	Type	Order Code	Pack <sup>(n)</sup> pieces	Weight g (1 pce)	
<b>1 End Stops</b> 10 mm 0.394 in Dark Grey	<b>BAZH1</b>	<b>1SNK 900 102 R0000</b>	20	23.90	
<b>2 End Sections</b> 2.55 mm 0.100 in Dark Grey	<b>ES4-D2</b>	<b>1SNK 505 960 R0000</b>	20	4.10	
<b>3 Jumper Bars</b> 2 poles 41 A 30 A Orange	<b>JB6-2</b>	<b>1SNK 906 302 R0000</b>	50	1.30	
	<b>JB6-3</b>	<b>1SNK 906 303 R0000</b>	50	2.10	
	<b>JB6-4</b>	<b>1SNK 906 304 R0000</b>	50	2.90	
	<b>JB6-5</b>	<b>1SNK 906 305 R0000</b>	50	3.60	
<b>4 Test Adapters</b> For test plugs DIA 2 mm 0.079 in Dark Grey	<b>JB6-10</b>	<b>1SNK 906 310 R0000</b>	20	7.40	
	For test plugs DIA 4 mm 0.160 in	<b>TP2</b>	<b>1SNK 900 203 R0000</b>	20	1.73
<b>5 Test Connectors</b> 5.2 mm 0.205 in spacing Dark Grey	<b>TP4</b>	<b>1SNK 900 205 R0000</b>	20	2.42	
	End module, 5.2 mm 0.205 in	<b>TC5</b>	<b>1SNK 900 200 R0000</b>	10	5.23
<b>6 Spacers</b> 0.8 mm 0.031 in spacing Dark Grey	<b>TC5-R1</b>	<b>1SNK 900 201 R0000</b>	10	5.23	
<b>7 Shield Connectors</b>	<b>ES-TC6</b>	<b>1SNK 900 105 R0000</b>	10	0.80	
<b>8 Terminal Block Markers</b>	<b>SHB</b>	<b>1SNK 900 602 R0000</b>	20	4.90	
	Blank card White	<b>MC612</b>	<b>1SNK 150 000 R0000</b>	22	0.06
	Universal wire markers holder Grey	<b>UMH</b>	<b>1SNK 900 611 R0000</b>	10	0.20
	Self adhesive strip White	<b>SAT6</b>	<b>1SNK 900 615 R0000</b>	5	6.00

Some accessories may modify the terminal block's ratings. See complete information in "Technical Datasheet".

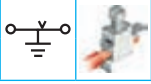

**4 mm<sup>2</sup>**  
**12 AWG**

# ZS4-PE Screw Clamp Terminal Block

## Ground

5.2 mm 0.205 in spacing

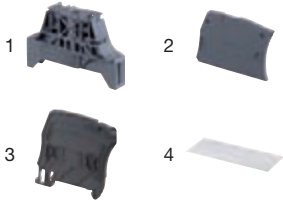
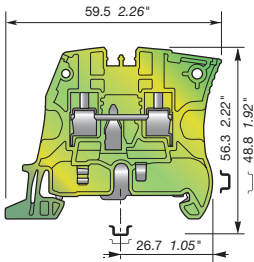

### Features and Benefits

Improve the safety of your installation in the event of a short-circuit thanks to our screwless rail contact:

- Design non operator dependent,
- Performances above the requirements of IEC 60947-7-2 terminal block standard,
- Secured snap on or remove from the rail.

### Main Technical Data

Connecting capacity	IEC	cULus - CSA
with 1 conductor per clamp	Rigid	0.2-4 mm <sup>2</sup>
	Flexible	0.22-4 mm <sup>2</sup>
	with ferrule	0.22-4 mm <sup>2</sup>
	Gauge	A3-B3
Rated cross section	4 mm <sup>2</sup>	12 AWG
Rated short-time withstand current (1s)	480 A	
Protection	IP 20	NEMA 1

### Mounting Instructions

Rail		DIN3-TH35
Wire stripping length		10.5 mm 0.413 in
Tool		Flat screwdriver Ø 3.5 mm Ø 0.138 in
Torque		0.6 Nm ± 0.1 5.31 lb.in ± 0.885

### Explosive atmosphere classification

IM2 II 2 GD Ex e I/II

CE	CB	RoHS	cUL	CSA	Gost	ATEX	IECEX	br-Ex	BV						Gost, Br-Ex, and BV: Pending - 2009
----	----	------	-----	-----	------	------	-------	-------	----	--	--	--	--	--	-------------------------------------

Description	Type	Order Code	Pack <sup>(ing)</sup> pieces	Weight g (1 pce)
<b>Ground</b> Screwless rail connection	Green-Yellow	<b>ZS4-PE</b> 1SNK 505 150 R0000	20	12.10

### ZS4-PE Terminal Block Accessories

1SNK 160 001 C0201

Description	Type	Order Code	Pack <sup>(ing)</sup> pieces	Weight g (1 pce)
1 <b>End Stops</b> 10 mm 0.394 in	Dark Grey	<b>BAM3</b> 1SNK 900 001 R0000	50	13.80
2 <b>End Sections</b> 2.2 mm 0.087 in	Dark Grey	<b>ES4</b> 1SNK 505 910 R0000	20	2.18
3 <b>Circuit Separators</b> 3 mm 0.118 in	Dark Grey	<b>CS-R1</b> 1SNK 900 103 R0000	20	5.20
4 <b>Terminal Block Markers</b>	Blank card	White <input type="checkbox"/> <b>MC512</b> 1SNK 140 000 R0000	22	0.06
	Universal wire markers holder	Grey <input type="checkbox"/> <b>UMH</b> 1SNK 900 611 R0000	10	0.20
	Self adhesive strip	White <input type="checkbox"/> <b>SAT5</b> 1SNK 900 614 R0000	5	6.00

Some accessories may modify the terminal block's ratings. See complete information in "Technical Datasheet".



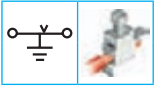

**6 mm<sup>2</sup>**  
**10 AWG**

# ZS6-PE Screw Clamp Terminal Block

## Ground

6 mm 0.236 in spacing

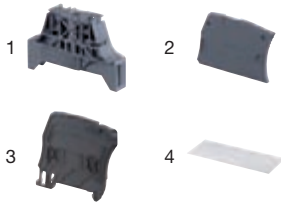
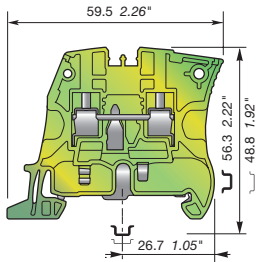
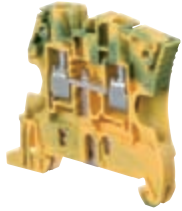

### Features and Benefits

Improve the safety of your installation in the event of a short-circuit thanks to our screwless rail contact:

- Design non operator dependent,
- Performances above the requirements of IEC 60947-7-2 terminal block standard,
- Secured snap on or remove from the rail.

### Main Technical Data

Connecting capacity	IEC	cULus - CSA
with 1 conductor per clamp	Rigid 0.2-4 mm <sup>2</sup>	24-10 AWG
	Flexible 0.22-4 mm <sup>2</sup>	24-10 AWG
	with ferrule 0.22-4 mm <sup>2</sup>	24-10 AWG
	Gauge A4-B3	
Maximum cross section	6 mm <sup>2</sup>	10 AWG
Maximum short circuit current (1s)	720 A	
Protection	IP 20	NEMA 1

### Mounting Instructions

Rail	DIN3-TH35
Wire stripping length	10.5 mm 0.413 in
Tool	Flat screwdriver Ø 4 mm Ø 0.157 in
Torque	0.85 Nm ± 0.15 7.52 lb.in ± 1.33

### Explosive atmosphere classification

IM2 II 2 GD Ex e I/II

CE	CB	RoHS	UL	CSA	Gost	ATEX	IECEx	Br-Ex	BV	Gost, Br-Ex, and BV: Pending - 2009
----	----	------	----	-----	------	------	-------	-------	----	-------------------------------------

Description	Type	Order Code	Pack <sup>(nsl)</sup> pieces	Weight g (1 pce)
<b>Ground</b> Screwless rail connection	Green-Yellow	<b>ZS6-PE</b> 1SNK 506 150 R0000	20	13.70

### ZS6-PE Terminal Block Accessories

1SNK 160 001 C0201

Description	Type	Order Code	Pack <sup>(nsl)</sup> pieces	Weight g (1 pce)
1 <b>End Stops</b> 10 mm 0.394 in	Dark Grey	<b>BAM3</b> 1SNK 900 001 R0000	50	13.80
2 <b>End Sections</b> 2.2 mm 0.087 in	Dark Grey	<b>ES4</b> 1SNK 505 910 R0000	20	2.18
3 <b>Circuit Separators</b> 3 mm 0.118 in	Dark Grey	<b>CS-R1</b> 1SNK 900 103 R0000	20	5.20
4 <b>Terminal Block Markers</b>	Blank card	White <b>MC612</b> 1SNK 150 000 R0000	22	0.06
	Universal wire markers holder	Grey <b>UMH</b> 1SNK 900 611 R0000	10	0.20
	Self adhesive strip	White <b>SAT6</b> 1SNK 900 615 R0000	5	6.00

Some accessories may modify the terminal block's ratings. See complete information in "Technical Datasheet".

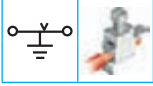

10 mm<sup>2</sup>  
6 AWG

# ZS10-PE Screw Clamp Terminal Block

## Ground

8 mm 0.315 in spacing

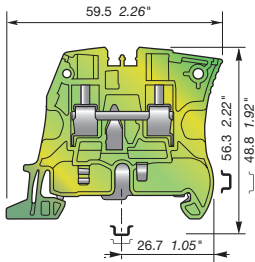

### Features and Benefits

Improve the safety of your installation in the event of a short-circuit thanks to our screwless rail contact:

- Design non operator dependent,
- Performances above the requirements of IEC 60947-7-2 terminal block standard,
- Secured snap on or remove from the rail,
- PE.N function available by combining ZS10-PE with ZS10-BL and 2 poles jumper bar JB8-2.

### Main Technical Data

Connecting capacity	IEC	cULus - CSA
with 1 conductor per clamp	Rigid 0.5-10 mm <sup>2</sup>	20-6 AWG
	Flexible 0.5-10 mm <sup>2</sup>	20-6 AWG
	with ferrule 0.5-10 mm <sup>2</sup>	24-8 AWG
	Gauge A5-B5	
Rated cross section	10 mm <sup>2</sup>	6 AWG
Rated short-time withstand current (1s)	1200 A	
Protection	IP 20	NEMA 1

### Mounting Instructions

Rail		DIN3-TH35
Wire stripping length		12 mm 0.472 in
Tool		Flat screwdriver Ø 4 mm Ø 0.157 in
Torque		1.3 Nm ± 0.3 11.5 lb.in ± 2.65

Explosive atmosphere classification

IM2 II 2 GD Ex e I/II

CE	CB	RoHS	cUL	CSA	Gost	ATEX	IECEX	br-Ex	BV										Gost, Br-Ex, and BV: Pending - 2009
----	----	------	-----	-----	------	------	-------	-------	----	--	--	--	--	--	--	--	--	--	-------------------------------------

Description	Type	Order Code	Pack <sup>(ing)</sup> pieces	Weight g (1 pce)
<b>Ground</b> Screwless rail connection	Green-Yellow	<b>ZS10-PE</b>	<b>1SNK 508 150 R0000</b>	20 22.50

### ZS10-PE Terminal Block Accessories

1SNK 160 001 C0201

Description	Type	Order Code	Pack <sup>(ing)</sup> pieces	Weight g (1 pce)
1 <b>End Stops</b> 10 mm 0.394 in Dark Grey	<b>BAM3</b>	<b>1SNK 900 001 R0000</b>	50	13.80
2 <b>End Sections</b> 2.2 mm 0.087 in Dark Grey	<b>ES4</b>	<b>1SNK 505 910 R0000</b>	20	2.18
3 <b>Jumper Bars</b> 2 poles 57 A 42 A Orange	<b>JB8-2</b>	<b>1SNK 908 302 R0000</b>	50	2.70
4 <b>Circuit Separators</b> 3 mm 0.118 in Dark Grey	<b>CS-R1</b>	<b>1SNK 900 103 R0000</b>	20	5.20
5 <b>Terminal Block Markers</b>				
Blank card	White	<b>MC812</b>	<b>1SNK 160 000 R0000</b>	22 0.09
Universal wire markers holder	Grey	<b>UMH</b>	<b>1SNK 900 611 R0000</b>	10 0.20
Self adhesive strip	White	<b>SAT8</b>	<b>1SNK 900 616 R0000</b>	5 6.00

Some accessories may modify the terminal block's ratings. See complete information in "Technical Datasheet".

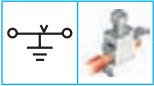

**16 mm<sup>2</sup>**  
**4 AWG**

# ZS16-PE Screw Clamp Terminal Block

## Ground

**10 mm 0.394 in spacing**

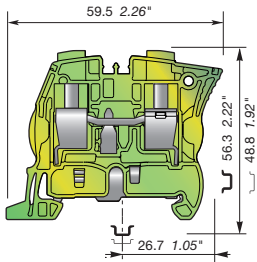

### Features and Benefits

Improve the safety of your installation in the event of a short-circuit thanks to our screwless rail contact:

- Design non operator dependent,
- Performances above the requirements of IEC 60947-7-2 terminal block standard,
- Secured snap on or remove from the rail,
- PE.N function available by combining ZS16-PE with ZS16-BL and 2 poles jumper bar JB10-2.

### Main Technical Data

Connecting capacity	IEC	cULus - CSA
with 1 conductor per clamp	Rigid	0.5-16 mm <sup>2</sup>
	Flexible	0.5-16 mm <sup>2</sup>
	with ferrule	0.5-10 mm <sup>2</sup>
	Gauge	A6-B6
Rated cross section	16 mm <sup>2</sup>	4 AWG
Rated short-time withstand current (1s)	1920 A	
Protection	IP 20	NEMA 1

### Mounting Instructions

Rail		DIN3-TH35
Wire stripping length		13.5 mm 0.531 in
Tool		Flat screwdriver Ø 5.5 mm Ø 0.217 in
Torque		2 Nm ± 0.4 17.7 lb.in ± 3.54

Explosive atmosphere classification

IM2 II 2 GD Ex e I/II

CE	CB	RoHS	cUL	UL	CSA	Gost	ATEX	IECEx	br-Ex	BV	Gost, Br-Ex, and BV: Pending - 2009
----	----	------	-----	----	-----	------	------	-------	-------	----	-------------------------------------

Description	Type	Order Code	Pack <sup>(n)</sup> pieces	Weight g (1 pce)
<b>Ground</b> Screwless rail connection	Green-Yellow	<b>ZS16-PE</b>	<b>1SNK 510 150 R0000</b>	20 32.00

### ZS16-PE Terminal Block Accessories

1SNK 160 001 C0201

Description	Type	Order Code	Pack <sup>(n)</sup> pieces	Weight g (1 pce)
1 <b>End Stops</b>	10 mm 0.394 in Dark Grey	<b>BAM3</b>	<b>1SNK 900 001 R0000</b>	50 13.80
2 <b>End Sections</b>	2.2 mm 0.087 in Dark Grey	<b>ES4</b>	<b>1SNK 505 910 R0000</b>	20 2.18
3 <b>Jumper Bars</b>	2 poles 76 A 67 A Orange	<b>JB10-2</b>	<b>1SNK 910 302 R0000</b>	50 4.60
4 <b>Circuit Separators</b>	3 mm 0.118 in Dark Grey	<b>CS-R1</b>	<b>1SNK 900 103 R0000</b>	20 5.20
5 <b>Terminal Block Markers</b>	Blank card White	<b>MC812</b>	<b>1SNK 160 000 R0000</b>	22 0.09
	Universal wire markers holder Grey	<b>UMH</b>	<b>1SNK 900 611 R0000</b>	10 0.20
	Self adhesive strip White	<b>SAT8</b>	<b>1SNK 900 616 R0000</b>	5 6.00

Some accessories may modify the terminal block's ratings. See complete information in "Technical Datasheet".

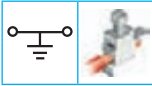

**35 mm<sup>2</sup>**  
**0 AWG**

# ZS35-PE Screw Clamp Terminal Block

## Ground

16 mm 0.630 in spacing

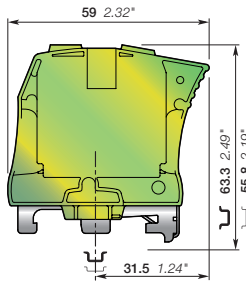
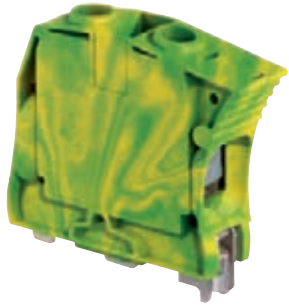

### Features and Benefits

Reliable electrical and mechanical contact with the rail that exceeds the requirements of IEC 60947-7-2 terminal block standard.

### Main Technical Data

Connecting capacity		IEC	cULus - CSA
with 1 conductor per clamp	Rigid	6-35 mm <sup>2</sup>	10-0 AWG
	Flexible	6-35 mm <sup>2</sup>	10-0 AWG
	with ferrule		
Gauge		A9	
Rated cross section		35 mm <sup>2</sup>	0 AWG
Rated short-time withstand current (1s)		4200 A	
Protection		IP 20	NEMA 1

### Mounting Instructions

Rail		DIN3-TH35
Wire stripping length		17 mm 0.669 in
Tool		Flat screwdriver
Screw clamp		Ø 6.5 mm Ø 0.256 in
Rail connection screw		Ø 5.5 mm Ø 0.217 in
Torque		
Screw clamp		2.65 Nm ± 0.15 23.5 lb.in ± 1.33
Rail connection screw		1.6 Nm ± 0.15 14.2 lb.in ± 1.33

CE	CB	RoHS	cULus	CSA	Gost	ATEX	IECEX	br-Ex	BV			Gost, Br-Ex, and BV: Pending - 2009
----	----	------	-------	-----	------	------	-------	-------	----	--	--	-------------------------------------

Description	Type	Order Code	Pack <sup>(mg)</sup> pieces	Weight g (1 pce)
<b>Ground</b> Screw rail connection	Green-Yellow	<b>ZS35-PE</b> 1SNK 516 150 R0000	20	81.80

### ZS35-PE Terminal Block Accessories

1SNK 160 001 C0201

Description	Type	Order Code	Pack <sup>(mg)</sup> pieces	Weight g (1 pce)
1 <b>End Stops</b>	10 mm 0.394 in Dark Grey	<b>BAZH1</b> 1SNK 900 102 R0000	20	23.90
2 <b>Terminal Block Markers</b>	Blank card White <input type="checkbox"/>	<b>MC812</b> 1SNK 160 000 R0000	22	0.09
	Universal wire markers holder Grey <input type="checkbox"/>	<b>UMH</b> 1SNK 900 611 R0000	10	0.20
	Self adhesive strip White <input type="checkbox"/>	<b>SAT8</b> 1SNK 900 616 R0000	5	6.00

Some accessories may modify the terminal block's ratings. See complete information in "Technical Datasheet".

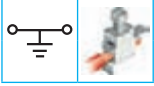

**70 mm<sup>2</sup>**  
**00 AWG**

# ZS70-PE Screw Clamp Terminal Block

## Ground

**22 mm 0.866 in** spacing

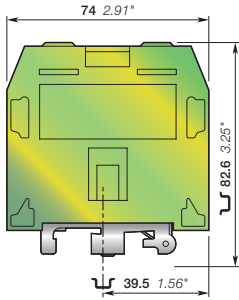

### Features and Benefits

Reliable electrical and mechanical contact with the rail that exceeds the requirements of IEC 60947-7-2 terminal block standard.

### Main Technical Data

Connecting capacity	IEC	cULus - CSA
with 1 conductor per clamp	Rigid	16-95 mm <sup>2</sup>
	Flexible	16-70 mm <sup>2</sup>
	with ferrule	
	Gauge	B11
Rated cross section	70 mm <sup>2</sup>	00 AWG
Rated short-time withstand current (1s)	8400 A	
Protection	IP 10	NEMA 1

### Mounting Instructions

Rail		DIN3-TH35
Wire stripping length		25 mm 0.984 in
Tool		Allen Key
Screw clamp		Ø 6 mm Ø 0.236 in
Rail connection screw		Ø 4 mm Ø 0.158 in
Torque		
Screw clamp		6.5 Nm ± 0.5 57.5 lb.in ± 4.4
Rail connection screw		2 Nm ± 0.5 17.7 lb.in ± 4.4

CE	CB	RoHS	cUL	UL	Gost	ATEX	IECEX	br-Ex	BV					Gost, Br-Ex, and BV: Pending - 2009
----	----	------	-----	----	------	------	-------	-------	----	--	--	--	--	-------------------------------------

Description	Type	Order Code	Pack <sup>(n)</sup> pieces	Weight g (1 pce)
Ground Screw rail connection	Green-Yellow	<b>ZS70-PE</b>	<b>1SNK 522 150 R0000</b>	10 222.00

### ZS70-PE Terminal Block Accessories

1SNK 160 001 C0201

Description	Type	Order Code	Pack <sup>(n)</sup> pieces	Weight g (1 pce)
1 <b>End Stops</b>	10 mm 0.394 in Dark Grey	<b>BAZH1</b>	<b>1SNK 900 102 R0000</b>	20 23.90
2 <b>Terminal Block Markers</b>	Blank card White	<b>MC812</b>	<b>1SNK 160 000 R0000</b>	22 0.09
	Universal wire markers holder Grey	<b>UMH</b>	<b>1SNK 900 611 R0000</b>	10 0.20
	Self adhesive strip White	<b>SAT8</b>	<b>1SNK 900 616 R0000</b>	5 6.00

Some accessories may modify the terminal block's ratings. See complete information in "Technical Datasheet".

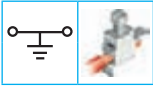

**95 mm<sup>2</sup>**  
**000 AWG**

# ZS95-PE Screw Clamp Terminal Block

## Ground

26 mm 1.023 in spacing

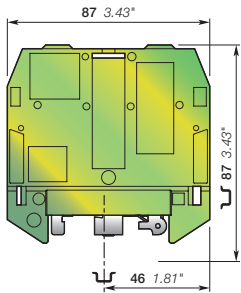
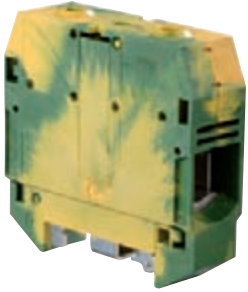

### Features and Benefits

Reliable electrical and mechanical contact with the rail that exceeds the requirements of IEC 60947-7-2 terminal block standard.

### Main Technical Data

Connecting capacity	IEC	cULus - CSA
with 1 conductor per clamp	Rigid	35-120 mm <sup>2</sup>
	Flexible	35-95 mm <sup>2</sup>
	with ferrule	
	Gauge	B12
Rated cross section		95 mm <sup>2</sup> 000 AWG
Rated short-time withstand current (1s)		11400 A
Protection		IP 10 NEMA 1

### Mounting Instructions

Rail		DIN3-TH35
Wire stripping length		26 mm 1.023 in
Tool		Allen Key
Screw clamp		Ø 6 mm Ø 0.236 in
Rail connection screw		Ø 4 mm Ø 0.158 in
Torque		
Screw clamp		9.25 Nm ± 0.25 81.7 lb.in ± 2.2
Rail connection screw		2 Nm ± 0.25 17.7 lb.in ± 2.2

CE	CB	RoHS	cULus	CSA	Gost	ATEX	IECEX	br-Ex	BV									Gost, Br-Ex, and BV: Pending - 2009
----	----	------	-------	-----	------	------	-------	-------	----	--	--	--	--	--	--	--	--	-------------------------------------

Description	Type	Order Code	Pack <sup>(ing)</sup> pieces	Weight g (1 pce)
<b>Ground</b> Screw rail connection	Green-Yellow	<b>ZS95-PE</b>	<b>1SNK 526 150 R0000</b>	10 278.00

### ZS95-PE Terminal Block Accessories

1SNK 160 001 C0201

Description	Type	Order Code	Pack <sup>(ing)</sup> pieces	Weight g (1 pce)
1 <b>End Stops</b>	10 mm 0.394 in Dark Grey	<b>BAZH1</b>	<b>1SNK 900 102 R0000</b>	20 23.90
2 <b>Terminal Block Markers</b>	Blank card White	<b>MC812</b>	<b>1SNK 160 000 R0000</b>	22 0.09
	Universal wire markers holder Grey	<b>UMH</b>	<b>1SNK 900 611 R0000</b>	10 0.20
	Self adhesive strip White	<b>SAT8</b>	<b>1SNK 900 616 R0000</b>	5 6.00

Some accessories may modify the terminal block's ratings. See complete information in "Technical Datasheet".

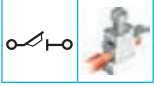

4 mm<sup>2</sup>  
10 AWG

# ZS4-S Screw Clamp Terminal Block

## Disconnect with Blade

5.2 mm 0.205 in spacing

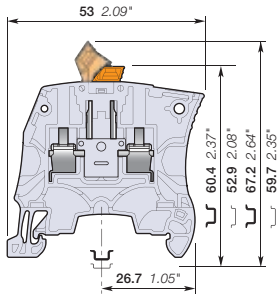

### Features and Benefits

- Ease your disconnect operations with the disconnect blade operated by hand or with a screwdriver,
- Same profile as ZS4 feed-through terminal block for aligned marking and identical end section use.

### Main Technical Data

Connecting capacity	IEC	cULus - CSA
with 1 conductor per clamp	Rigid 0.2-4 mm <sup>2</sup>	24-10 AWG
	Flexible 0.22-4 mm <sup>2</sup>	24-10 AWG
	with ferrule 0.22-4 mm <sup>2</sup>	24-12 AWG
	Gauge A3-B3	
with 2 conductors per clamp	Rigid 0.2-1 mm <sup>2</sup>	24-18 AWG
	Flexible 0.22-1 mm <sup>2</sup>	24-18 AWG
	with twin ferrule 0.22-1.5 mm <sup>2</sup>	24-16 AWG
Rated cross section	4 mm <sup>2</sup>	10 AWG
Rated current	25 A	25 A
Rated short-time withstand current (1s)	480 A	
Rated voltage	400 V	150 V
Impulse withstand voltage	6000 V	
Protection	IP 20	NEMA 1

### Mounting Instructions

Rail		DIN3-TH35
Wire stripping length		10.5 mm 0.413 in
Tool		Flat screwdriver Ø 3.5 mm Ø 0.138 in
Torque		0.6 Nm ± 0.1 5.31 lb.in ± 0.885



Gost and BV: Pending - 2009

### Ordering Details

#### ZS4-S Disconnect Screw Clamp Terminal Block

Description	Type	Order Code	Pack <sup>(ng)</sup> pieces	Weight g (1 pce)
Profile aligned with ZS4	Grey <input type="checkbox"/>	<b>ZS4-S</b>	<b>1SNK 505 310 R0000</b>	50 8.60
	Blue <input type="checkbox"/>	<b>ZS4-S-BL</b>	<b>1SNK 505 320 R0000</b>	50 8.60
	Orange <input type="checkbox"/>	<b>ZS4-S-OR</b>	<b>1SNK 505 330 R0000</b>	50 8.60

### ZS4-S Terminal Block Accessories

1SNK 160 001 C0201

Description	Type	Order Code	Pack <sup>(ng)</sup> pieces	Weight g (1 pce)
1 <b>End Stops</b>	10 mm 0.394 in Dark Grey <input type="checkbox"/>	<b>BAM3</b>	<b>1SNK 900 001 R0000</b>	50 13.80
2 <b>End Sections</b>	2.2 mm 0.087 in Dark Grey <input type="checkbox"/>	<b>ES4</b>	<b>1SNK 505 910 R0000</b>	20 2.18
3 <b>Circuit Separators</b>	3 mm 0.118 in Dark Grey <input type="checkbox"/>	<b>CS-R1</b>	<b>1SNK 900 103 R0000</b>	20 5.20
4 <b>Shield Connectors</b>		<b>SHBS</b>	<b>1SNK 900 600 R0000</b>	20 3.50
5 <b>Protecting Covers</b>	5.2 mm .205 in spacing Transparent <input checked="" type="checkbox"/>	<b>PL5</b>	<b>1SNK 900 618 R0000</b>	20 1.50
6 <b>Terminal Block Markers</b>	Blank card White <input type="checkbox"/>	<b>MC512</b>	<b>1SNK 140 000 R0000</b>	22 0.06
	Universal wire markers holder Grey <input type="checkbox"/>	<b>UMH</b>	<b>1SNK 900 611 R0000</b>	10 0.20
	Self adhesive strip White <input type="checkbox"/>	<b>SAT5</b>	<b>1SNK 900 614 R0000</b>	5 6.00

Some accessories may modify the terminal block's ratings. See complete information in "Technical Datasheet".

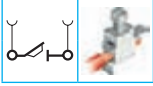

**4 mm<sup>2</sup>**  
**10 AWG**

# ZS4-S-T Screw Clamp Terminal Block

## Disconnect with Blade - with Test Socket Screws

5.2 mm 0.205 in spacing

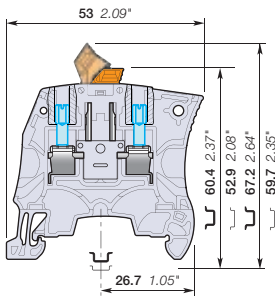

### Features and Benefits

- Ease your test operations with the two built-in test socket screws,
- Screwdriver or hand operated disconnect blade,
- Same profile as ZS4 feed-through terminal block for aligned marking and identical end section use.

### Main Technical Data

Connecting capacity	IEC	cULus - CSA
with 1 conductor per clamp	Rigid	0.2-4 mm <sup>2</sup> 24-10 AWG
	Flexible	0.22-4 mm <sup>2</sup> 24-10 AWG
	with ferrule	0.22-4 mm <sup>2</sup> 24-12 AWG
with 2 conductors per clamp	Gauge	A3-B3
	Rigid	0.2-1 mm <sup>2</sup> 24-18 AWG
	Flexible	0.22-1 mm <sup>2</sup> 24-18 AWG
with twin ferrule	0.22-1.5 mm <sup>2</sup> 24-16/24-18 AWG	
Rated cross section	4 mm <sup>2</sup>	10 AWG
Rated current	25 A	25 A
Rated short-time withstand current (1s)	480 A	
Rated voltage	400 V	150 V
Impulse withstand voltage	6000 V	
Protection	IP 20	NEMA 1

### Mounting Instructions

Rail		DIN3-TH35
Wire stripping length		10.5 mm 0.413 in
Tool		Flat screwdriver Ø 3.5 mm Ø 0.138 in
Torque		0.6 Nm ± 0.1 5.31 lb.in ± 0.885

						Gost and BV: Pending - 2009
--	--	--	--	--	--	-----------------------------

### Ordering Details

#### ZS4-S-T Disconnect Screw Clamp Terminal Block

Description	Type	Order Code	Pack <sup>(ing)</sup> pieces	Weight g (1 pce)
Profile aligned with ZS4, with 2 test socket screws DIA 2 mm 0.079 in	Grey <input type="checkbox"/>	<b>ZS4-S-T2</b>	1SNK 505 311 R0000	50 8.90
	Blue <input type="checkbox"/>	<b>ZS4-S-T2-BL</b>	1SNK 505 321 R0000	50 8.90
	Orange <input type="checkbox"/>	<b>ZS4-S-T2-OR</b>	1SNK 505 331 R0000	50 8.90
Profile aligned with ZS4, with 2 test socket screws DIA 2.3 mm 0.091 in	Grey <input type="checkbox"/>	<b>ZS4-S-T2.3</b>	1SNK 505 312 R0000	50 8.80

### ZS4-S-T Terminal Block Accessories

1SNK 160 001 C0201

Description	Type	Order Code	Pack <sup>(ing)</sup> pieces	Weight g (1 pce)
1 End Stops	10 mm 0.394 in Dark Grey <input type="checkbox"/>	<b>BAM3</b>	1SNK 900 001 R0000	50 13.80
2 End Sections	2.2 mm 0.087 in Dark Grey <input type="checkbox"/>	<b>ES4</b>	1SNK 505 910 R0000	20 2.18
3 Circuit Separators	3 mm 0.118 in Dark Grey <input type="checkbox"/>	<b>CS-R1</b>	1SNK 900 103 R0000	20 5.20
4 Shield Connectors	<input type="checkbox"/>	<b>SHBS</b>	1SNK 900 600 R0000	20 3.50
5 Protecting Covers	5.2 mm .205 in spacing Transparent <input checked="" type="checkbox"/>	<b>PL5</b>	1SNK 900 618 R0000	20 1.50
6 Terminal Block Markers	Blank card White <input type="checkbox"/>	<b>MC512</b>	1SNK 140 000 R0000	22 0.06
	Universal wire markers holder Grey <input type="checkbox"/>	<b>UMH</b>	1SNK 900 611 R0000	10 0.20
	Self adhesive strip White <input type="checkbox"/>	<b>SAT5</b>	1SNK 900 614 R0000	5 6.00

Some accessories may modify the terminal block's ratings. See complete information in "Technical Datasheet".







4 mm<sup>2</sup>  
10 AWG

# ZS4-S-R1 Screw Clamp Terminal Block

## Disconnect with Blade

6 mm 0.236 in spacing

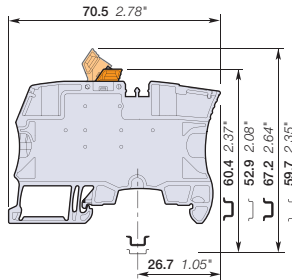

### Features and Benefits

- Simplify the alternated distribution thanks to the two jumper channels aligned with ZS4 feed-through terminal blocks,
- Ease your disconnect operations with the disconnect blade operated by hand or with a screwdriver.

### Main Technical Data

Connecting capacity	IEC	cULus - CSA
with 1 conductor per clamp	Rigid	0.2-4 mm <sup>2</sup>
	Flexible	0.22-4 mm <sup>2</sup>
	with ferrule	0.22-4 mm <sup>2</sup>
	Gauge	A3-B3
with 2 conductors per clamp	Rigid	0.2-1 mm <sup>2</sup>
	Flexible	0.22-1 mm <sup>2</sup>
	with twin ferrule	0.22-1.5 mm <sup>2</sup>
Rated cross section	4 mm <sup>2</sup>	10 AWG
Rated current	26 A	26 A
Rated short-time withstand current (1s)	480 A	
Rated voltage	400 V	150 V
Impulse withstand voltage	6000 V	
Protection	IP 20	NEMA 1

### Mounting Instructions

Rail		DIN3-TH35
Wire stripping length		10.5 mm 0.413 in
Tool		Flat screwdriver Ø 3.5 mm Ø 0.138 in
Torque		0.6 Nm ± 0.1 5.31 lb.in ± 0.885

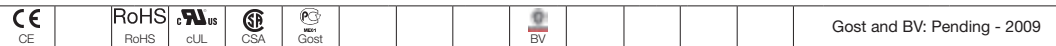

### Ordering Details

#### ZS4-S-R1 Disconnect Screw Clamp Terminal Block

Description	Type	Order Code	Pack <sup>(ng)</sup> pieces	Weight g (1 pce)
Profile aligned with ZS4-SF	Grey	<b>ZS4-S-R1</b>	<b>1SNK 506 310 R0000</b>	50 13.20
	Blue	<b>ZS4-S-R1-BL</b>	<b>1SNK 506 320 R0000</b>	50 13.20
	Orange	<b>ZS4-S-R1-OR</b>	<b>1SNK 506 330 R0000</b>	50 13.20

### ZS4-S-R1 Terminal Block Accessories

1SNK 160 001 C0201

Description	Type	Order Code	Pack <sup>(ng)</sup> pieces	Weight g (1 pce)
1 <b>End Stops</b>	10 mm 0.394 in Dark Grey	<b>BAM3</b>	<b>1SNK 900 001 R0000</b>	50 13.80
2 <b>Jumper Bars</b>	2 poles 41 A 30 A Orange	<b>JB6-2</b>	<b>1SNK 906 302 R0000</b>	50 1.30
	3 poles	<b>JB6-3</b>	<b>1SNK 906 303 R0000</b>	50 2.10
	4 poles	<b>JB6-4</b>	<b>1SNK 906 304 R0000</b>	50 2.90
	5 poles	<b>JB6-5</b>	<b>1SNK 906 305 R0000</b>	50 3.60
	10 poles	<b>JB6-10</b>	<b>1SNK 906 310 R0000</b>	20 7.40
3 <b>Test Adapters</b>	For test plugs DIA 2 mm 0.079 in Dark Grey	<b>TP2</b>	<b>1SNK 900 203 R0000</b>	20 1.73
	For test plugs DIA 4 mm 0.160 in	<b>TP4</b>	<b>1SNK 900 205 R0000</b>	20 2.42
4 <b>Test Connectors</b>	5.2 mm 0.205 in spacing Dark Grey	<b>TC5</b>	<b>1SNK 900 200 R0000</b>	10 5.23
	End module, 5.2 mm 0.205 in	<b>TC5-R1</b>	<b>1SNK 900 201 R0000</b>	10 5.23
5 <b>Spacers</b>	0.8 mm 0.031 in spacing Dark Grey	<b>ES-TC6</b>	<b>1SNK 900 105 R0000</b>	10 0.80
6 <b>Terminal Block Markers</b>	Blank card White	<b>MC612</b>	<b>1SNK 150 000 R0000</b>	22 0.06
	Universal wire markers holder Grey	<b>UMH</b>	<b>1SNK 900 611 R0000</b>	10 0.20
	Self adhesive strip White	<b>SAT6</b>	<b>1SNK 900 615 R0000</b>	5 6.00

Some accessories may modify the terminal block's ratings. See complete information in "Technical Datasheet".



**4 mm<sup>2</sup>**  
**10 AWG**

# ZS4-S-T-R1 Screw Clamp Terminal Block

## Disconnect with Blade - with Test Socket Screws

6 mm 0.236 in spacing

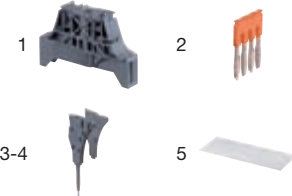
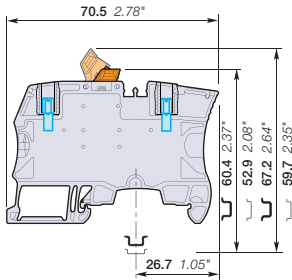
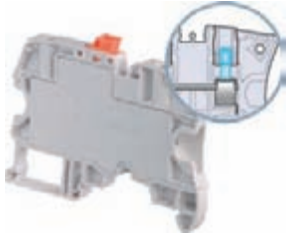

### Features and Benefits

- Ease your test operations with the two built-in test socket screws,
- Screwdriver or hand operated disconnect blade,
- Simplify the alternated distribution thanks to the two jumper channels aligned with ZS4 feed-through terminal blocks.

### Main Technical Data

Connecting capacity	IEC	cULus - CSA
with 1 conductor per clamp	Rigid	0.2-4 mm <sup>2</sup> 24-10 AWG
	Flexible	0.22-4 mm <sup>2</sup> 24-10 AWG
	with ferrule	0.22-4 mm <sup>2</sup> 24-12 AWG
Gauge		A3-B3
with 2 conductors per clamp	Rigid	0.2-1 mm <sup>2</sup> 24-18 AWG
	Flexible	0.22-1 mm <sup>2</sup> 24-18 AWG
	with twin ferrule	0.22-1.5 mm <sup>2</sup> 24-16 AWG
Rated cross section	4 mm <sup>2</sup>	10 AWG
Rated current	26 A	26 A
Rated short-time withstand current (1s)	480 A	
Rated voltage	400 V	150 V
Impulse withstand voltage	6000 V	
Protection	IP 20	NEMA 1

### Mounting Instructions

Rail		DIN3-TH35
Wire stripping length		10.5 mm 0.413 in
Tool		Flat screwdriver Ø 3.5 mm Ø 0.138 in
Torque		0.6 Nm ± 0.1 5.31 lb.in ± 0.885

CE	RoHS	UL	CSA	CCC	Gost	BV	Gost and BV: Pending - 2009
----	------	----	-----	-----	------	----	-----------------------------

### Ordering Details

#### ZS4-S-T-R1 Disconnect Screw Clamp Terminal Block

Description	Type	Order Code	Pack <sup>(ing)</sup> pieces	Weight g (1 pce)
Profile aligned with ZS4-SF, with 2 test socket screws DIA 2 mm 0.079 in	Grey	<b>ZS4-S-T2-R1</b>	<b>1SNK 506 311 R0000</b>	50 14.20
	Blue	<b>ZS4-S-T2-R1-BL</b>	<b>1SNK 506 321 R0000</b>	50 14.20
	Orange	<b>ZS4-S-T2-R1-OR</b>	<b>1SNK 506 331 R0000</b>	50 14.20
Profile aligned with ZS4-SF, with 2 test socket screws DIA 2.3 mm 0.091 in	Grey	<b>ZS4-S-T2.3-R1</b>	<b>1SNK 506 312 R0000</b>	50 14.20

### ZS4-S-T-R1 Terminal Block Accessories

1SNK 160 001 C0201

Description	Type	Order Code	Pack <sup>(ing)</sup> pieces	Weight g (1 pce)
1 <b>End Stops</b>	10 mm 0.394 in Dark Grey	<b>BAM3</b>	<b>1SNK 900 001 R0000</b>	50 13.80
2 <b>Jumper Bars</b>	2 poles 41 A 30 A Orange	<b>JB6-2</b>	<b>1SNK 906 302 R0000</b>	50 1.30
	3 poles	<b>JB6-3</b>	<b>1SNK 906 303 R0000</b>	50 2.10
	4 poles	<b>JB6-4</b>	<b>1SNK 906 304 R0000</b>	50 2.90
	5 poles	<b>JB6-5</b>	<b>1SNK 906 305 R0000</b>	50 3.60
	10 poles	<b>JB6-10</b>	<b>1SNK 906 310 R0000</b>	20 7.40
3 <b>Test Connectors</b>	5.2 mm 0.205 in spacing Dark Grey	<b>TC5</b>	<b>1SNK 900 200 R0000</b>	10 5.23
	End module, 5.2 mm 0.205 in	<b>TC5-R1</b>	<b>1SNK 900 201 R0000</b>	10 5.23
4 <b>Spacers</b>	0.8 mm 0.031 in spacing Dark Grey	<b>ES-TC6</b>	<b>1SNK 900 105 R0000</b>	10 0.80
5 <b>Terminal Block Markers</b>	Blank card White	<b>MC612</b>	<b>1SNK 150 000 R0000</b>	22 0.06
	Universal wire markers holder Grey	<b>UMH</b>	<b>1SNK 900 611 R0000</b>	10 0.20
	Self adhesive strip White	<b>SAT6</b>	<b>1SNK 900 615 R0000</b>	5 6.00

Some accessories may modify the terminal block's ratings. See complete information in "Technical Datasheet".



4 mm<sup>2</sup>  
10 AWG

# ZS4-SP Screw Clamp Terminal Block

## Disconnect with Plug

5.2 mm 0.205 in spacing

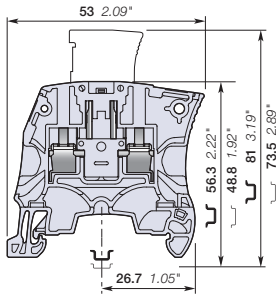

### Features and Benefits

- Save time with our screwless component holder plug,
- Same profile as ZS4 feed-through terminal block for aligned marking and identical end section use.

### Main Technical Data

Connecting capacity	IEC	cULus - CSA
with 1 conductor per clamp	Rigid	0.2-4 mm <sup>2</sup>
	Flexible	0.22-4 mm <sup>2</sup>
	with ferrule	0.22-4 mm <sup>2</sup>
Gauge		A3-B3
with 2 conductors per clamp	Rigid	0.2-1 mm <sup>2</sup>
	Flexible	0.22-1 mm <sup>2</sup>
	with twin ferrule	0.22-1.5 mm <sup>2</sup>
Rated cross section	4 mm <sup>2</sup>	10 AWG
Rated current	20 A	20 A
Rated short-time withstand current (1s)	480 A	
Rated voltage	400 V	150 V
Impulse withstand voltage	6000 V	
Protection	IP 20	NEMA 1

### Mounting Instructions

Rail		DIN3-TH35
Wire stripping length		10.5 mm 0.413 in
Tool		Flat screwdriver Ø 3.5 mm Ø 0.138 in
Torque		0.6 Nm ± 0.1 5.31 lb.in ± 0.885

CE	RoHS	UL	CSA	CCC	Gost	BV	Gost and BV: Pending - 2009
----	------	----	-----	-----	------	----	-----------------------------

### Ordering Details

#### ZS4-SP Disconnect Screw Clamp Terminal Block

Description	Type	Order Code	Pack <sup>(ing)</sup> pieces	Weight g (1 pce)
Profile aligned with ZS4, plug delivered separately	Grey <input type="checkbox"/>	<b>ZS4-SP</b>	<b>1SNK 505 313 R0000</b>	50 8.20

### ZS4-SP Terminal Block Accessories

1SNK 160 001 C0201

Description	Type	Order Code	Pack <sup>(ing)</sup> pieces	Weight g (1 pce)
1 <b>End Stops</b>	10 mm 0.394 in Dark Grey <input type="checkbox"/>	<b>BAM3</b>	<b>1SNK 900 001 R0000</b>	50 13.80
2 <b>End Sections</b>	2.2 mm 0.087 in Dark Grey <input type="checkbox"/>	<b>ES4</b>	<b>1SNK 505 910 R0000</b>	20 2.18
3 <b>Component Plugs</b>	Components in series with circuit Dark Grey <input type="checkbox"/>	<b>PG5</b>	<b>1SNK 900 401 R0000</b>	20 3.45
4 <b>Disconnect Plugs</b>	Equipped with linking bar Orange <input type="checkbox"/>	<b>PG5-R1</b>	<b>1SNK 900 402 R0000</b>	20 3.45
5 <b>Shield Connectors</b>		<b>SHBS</b>	<b>1SNK 900 600 R0000</b>	20 3.50
6 <b>Terminal Block Markers</b>	Blank card White <input type="checkbox"/>	<b>MC512</b>	<b>1SNK 140 000 R0000</b>	22 0.06
	Universal wire markers holder Grey <input type="checkbox"/>	<b>UMH</b>	<b>1SNK 900 611 R0000</b>	10 0.20
	Self adhesive strip White <input type="checkbox"/>	<b>SAT5</b>	<b>1SNK 900 614 R0000</b>	5 6.00

Some accessories may modify the terminal block's ratings. See complete information in "Technical Datasheet".





**4 mm<sup>2</sup>**  
**10 AWG**

# ZS4-SP-T2 Screw Clamp Terminal Block

Disconnect with Plug - with Test Socket Screws

5.2 mm 0.205 in spacing

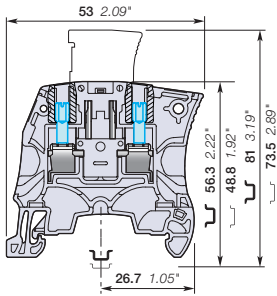
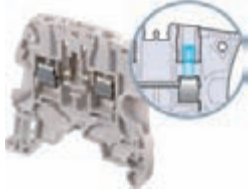

## Features and Benefits

- Ease your test operations with the 2 built-in test socket screws DIA 2 mm 0.079 in,
- Save time with our screwless component holder plug,
- Same profile as ZS4 feed-through terminal block for aligned marking and identical end section use.

## Main Technical Data

Connecting capacity	IEC	cULus - CSA
with 1 conductor per clamp	Rigid 0.2-4 mm <sup>2</sup>	24-10 AWG
	Flexible 0.22-4 mm <sup>2</sup>	24-10 AWG
	with ferrule 0.22-4 mm <sup>2</sup>	24-12 AWG
	Gauge A3-B3	
with 2 conductors per clamp	Rigid 0.2-1 mm <sup>2</sup>	24-18 AWG
	Flexible 0.22-1 mm <sup>2</sup>	24-18 AWG
	with twin ferrule 0.22-1.5 mm <sup>2</sup>	24-16 AWG
Rated cross section	4 mm <sup>2</sup>	10 AWG
Rated current	20 A	20 A
Rated short-time withstand current (1s)	480 A	
Rated voltage	400 V	150 V
Impulse withstand voltage	6000 V	
Protection	IP 20	NEMA 1

## Mounting Instructions

Rail		DIN3-TH35
Wire stripping length		10.5 mm 0.413 in
Tool		Flat screwdriver Ø 3.5 mm Ø 0.138 in
Torque		0.6 Nm ± 0.1 5.31 lb.in ± 0.885

						Gost and BV: Pending - 2009
--	--	--	--	--	--	-----------------------------

## Ordering Details

### ZS4-SP-T2 Disconnect Screw Clamp Terminal Block

Description	Type	Order Code	Pack <sup>(ing)</sup> pieces	Weight g (1 pce)
Profile aligned with ZS4, with 2 test socket screws DIA 2 mm 0.079 in, plug delivered separately	Grey <input type="checkbox"/>	<b>ZS4-SP-T2</b> 1SNK 505 314 R0000	50	8.40

## ZS4-SP-T2 Terminal Block Accessories

1SNK 160 001 C0201

Description	Type	Order Code	Pack <sup>(ing)</sup> pieces	Weight g (1 pce)	
1 <b>End Stops</b> 10 mm 0.394 in	Dark Grey <input type="checkbox"/>	<b>BAM3</b> 1SNK 900 001 R0000	50	13.80	
2 <b>End Sections</b> 2.2 mm 0.087 in	Dark Grey <input type="checkbox"/>	<b>ES4</b> 1SNK 505 910 R0000	20	2.18	
3 <b>Component Plugs</b> Components in series with circuit	Dark Grey <input type="checkbox"/>	<b>PG5</b> 1SNK 900 401 R0000	20	3.45	
4 <b>Disconnect Plugs</b> Equipped with linking bar	Orange <input type="checkbox"/>	<b>PG5-R1</b> 1SNK 900 402 R0000	20	3.45	
5 <b>Shield Connectors</b>		<b>SHBS</b> 1SNK 900 600 R0000	20	3.50	
6 <b>Terminal Block Markers</b>	Blank card	White <input type="checkbox"/>	<b>MC512</b> 1SNK 140 000 R0000	22	0.06
	Universal wire markers holder	Grey <input type="checkbox"/>	<b>UMH</b> 1SNK 900 611 R0000	10	0.20
	Self adhesive strip	White <input type="checkbox"/>	<b>SAT5</b> 1SNK 900 614 R0000	5	6.00

Some accessories may modify the terminal block's ratings. See complete information in "Technical Datasheet".





4 mm<sup>2</sup>  
10 AWG

# ZS4-SP-R1 Screw Clamp Terminal Block

## Disconnect with Plug

6 mm 0.236 in spacing

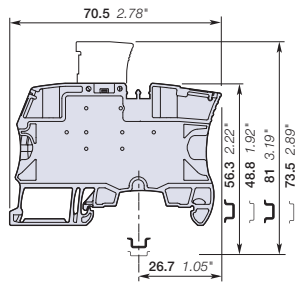

### Features and Benefits

- Simplify the alternated distribution between feed-through and disconnect circuits thanks to the two aligned jumper channels,
- Save time with our screwless component holder plug.

### Main Technical Data

Connecting capacity	IEC	cULus - CSA
with 1 conductor per clamp	Rigid	0.2-4 mm <sup>2</sup> 24-10 AWG
	Flexible	0.22-4 mm <sup>2</sup> 24-10 AWG
	with ferrule	0.22-4 mm <sup>2</sup> 24-12 AWG
Gauge		A3-B3
with 2 conductors per clamp	Rigid	0.2-1 mm <sup>2</sup> 24-18 AWG
	Flexible	0.22-1 mm <sup>2</sup> 24-18 AWG
	with twin ferrule	0.22-1.5 mm <sup>2</sup> 24-16 AWG
Rated cross section	4 mm <sup>2</sup>	10 AWG
Rated current	20 A	20 A
Rated short-time withstand current (1s)	480 A	
Rated voltage	400 V	150 V
Impulse withstand voltage	6000 V	
Protection	IP 20	NEMA 1

### Mounting Instructions

Rail		DIN3-TH35
Wire stripping length		10.5 mm 0.413 in
Tool		Flat screwdriver Ø 3.5 mm Ø 0.138 in
Torque		0.6 Nm ± 0.1 5.31 lb.in ± 0.885

CE	RoHS	cUL	CSA	PC	Gost	BV	Gost and BV: Pending - 2009
----	------	-----	-----	----	------	----	-----------------------------

### Ordering Details

#### ZS4-SP-R1 Disconnect Screw Clamp Terminal Block

Description	Type	Order Code	Pack <sup>(ng)</sup> pieces	Weight g (1 pce)
Profile aligned with ZS4-SF, plug delivered separately	Grey <input type="checkbox"/>	<b>ZS4-SP-R1</b> 1SNK 506 313 R0000	50	14.20

### ZS4-SP-R1 Terminal Block Accessories

1SNK 160 001 C0201

Description	Type	Order Code	Pack <sup>(ng)</sup> pieces	Weight g (1 pce)
1 <b>End Stops</b> 10 mm 0.394 in	Dark Grey <input type="checkbox"/>	<b>BAM3</b> 1SNK 900 001 R0000	50	13.80
2 <b>Component Plugs</b> Components in series with circuit	Dark Grey <input type="checkbox"/>	<b>PG5</b> 1SNK 900 401 R0000	20	3.45
3 <b>Disconnect Plugs</b> Equipped with linking bar	Orange <input type="checkbox"/>	<b>PG5-R1</b> 1SNK 900 402 R0000	20	3.45
4 <b>Jumper Bars</b> 2 poles 41 A 30 A	Orange <input type="checkbox"/>	<b>JB6-2</b> 1SNK 906 302 R0000	50	1.30
3 poles		<b>JB6-3</b> 1SNK 906 303 R0000	50	2.10
4 poles		<b>JB6-4</b> 1SNK 906 304 R0000	50	2.90
5 poles		<b>JB6-5</b> 1SNK 906 305 R0000	50	3.60
10 poles		<b>JB6-10</b> 1SNK 906 310 R0000	20	7.40
5 <b>Test Adapters</b> For test plugs DIA 2 mm 0.079 in	Dark Grey <input type="checkbox"/>	<b>TP2</b> 1SNK 900 203 R0000	20	1.73
For test plugs DIA 4 mm 0.160 in		<b>TP4</b> 1SNK 900 205 R0000	20	2.42
6 <b>Test Connectors</b> 5.2 mm 0.205 in spacing	Dark Grey <input type="checkbox"/>	<b>TC5</b> 1SNK 900 200 R0000	10	5.23
End module, 5.2 mm 0.205 in		<b>TC5-R1</b> 1SNK 900 201 R0000	10	5.23
7 <b>Spacers</b> 0.8 mm 0.031 in spacing	Dark Grey <input type="checkbox"/>	<b>ES-TC6</b> 1SNK 900 105 R0000	10	0.80
8 <b>Terminal Block</b> Blank card	White <input type="checkbox"/>	<b>MC612</b> 1SNK 150 000 R0000	22	0.06
<b>Markers</b> Universal wire markers holder	Grey <input type="checkbox"/>	<b>UMH</b> 1SNK 900 611 R0000	10	0.20
Self adhesive strip	White <input type="checkbox"/>	<b>SAT6</b> 1SNK 900 615 R0000	5	6.00

Some accessories may modify the terminal block's ratings. See complete information in "Technical Datasheet".



4 mm<sup>2</sup>  
10 AWG

# ZS4-SP-T2-R1 Screw Clamp Terminal Block

Disconnect with Plug - with Test Socket Screws

6 mm 0.236 in spacing

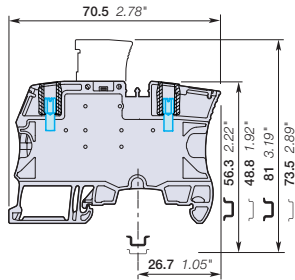
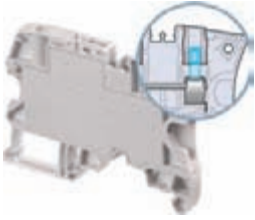

## Features and Benefits

- Ease your test operations with the two built-in test socket screws DIA 2 mm 0.079 in,
- Save time with our screwless component holder plug,
- Simplify the distribution between feed-through and disconnect circuits thanks to the two aligned jumper channels.

## Main Technical Data

Connecting capacity	IEC	cULus - CSA
with 1 conductor per clamp	Rigid 0.2-4 mm <sup>2</sup>	24-10 AWG
	Flexible 0.22-4 mm <sup>2</sup>	24-10 AWG
	with ferrule 0.22-4 mm <sup>2</sup>	24-12 AWG
	Gauge A3-B3	
with 2 conductors per clamp	Rigid 0.2-1 mm <sup>2</sup>	24-18 AWG
	Flexible 0.22-1 mm <sup>2</sup>	24-18 AWG
	with twin ferrule 0.22-1.5 mm <sup>2</sup>	24-16 AWG
Rated cross section	4 mm <sup>2</sup>	10 AWG
Rated current	20 A	20 A
Rated short-time withstand current (1s)	480 A	
Rated voltage	400 V	150 V
Impulse withstand voltage	6000 V	
Protection	IP 20	NEMA 1

## Mounting Instructions

Rail		DIN3-TH35
Wire stripping length		10.5 mm 0.413 in
Tool		Flat screwdriver Ø 3.5 mm Ø 0.138 in
Torque		0.6 Nm ± 0.1 5.31 lb.in ± 0.885

CE	RoHS	UL	CSA	CCC	Gost	BV	Gost and BV: Pending - 2009
----	------	----	-----	-----	------	----	-----------------------------

## Ordering Details

### ZS4-SP-T2-R1 Disconnect Screw Clamp Terminal Block

Description	Type	Order Code	Pack <sup>(ing)</sup> pieces	Weight g (1 pce)
Profile aligned with ZS4-SF, with 2 test socket screws DIA 2 mm 0.079 in, plug delivered separately	Grey <input type="checkbox"/>	<b>ZS4-SP-T2-R1</b> 1SNK 506 314 R0000	50	14.20

## ZS4-SP-T2-R1 Terminal Block Accessories

1SNK 160 001 C0201

Description	Type	Order Code	Pack <sup>(ing)</sup> pieces	Weight g (1 pce)	
1 End Stops 10 mm 0.394 in	Dark Grey <input type="checkbox"/>	<b>BAM3</b> 1SNK 900 001 R0000	50	13.80	
2 Component Plugs Components in series with circuit	Dark Grey <input type="checkbox"/>	<b>PG5</b> 1SNK 900 401 R0000	20	3.45	
3 Disconnect Plugs Equipped with linking bar	Orange <input type="checkbox"/>	<b>PG5-R1</b> 1SNK 900 402 R0000	20	3.45	
4 Jumper Bars 2 poles 41 A 30 A	Orange <input type="checkbox"/>	<b>JB6-2</b> 1SNK 906 302 R0000	50	1.30	
		<b>JB6-3</b> 1SNK 906 303 R0000	50	2.10	
		<b>JB6-4</b> 1SNK 906 304 R0000	50	2.90	
		<b>JB6-5</b> 1SNK 906 305 R0000	50	3.60	
		<b>JB6-10</b> 1SNK 906 310 R0000	20	7.40	
5 Test Connectors 5.2 mm 0.205 in spacing	Dark Grey <input type="checkbox"/>	<b>TC5</b> 1SNK 900 200 R0000	10	5.23	
		<b>TC5-R1</b> 1SNK 900 201 R0000	10	5.23	
6 Spacers 0.8 mm 0.031 in spacing	Dark Grey <input type="checkbox"/>	<b>ES-TC6</b> 1SNK 900 105 R0000	10	0.80	
7 Terminal Block Markers	Blank card	White <input type="checkbox"/>	<b>MC612</b> 1SNK 150 000 R0000	22	0.06
	Universal wire markers holder	Grey <input type="checkbox"/>	<b>UMH</b> 1SNK 900 611 R0000	10	0.20
	Self adhesive strip	White <input type="checkbox"/>	<b>SAT6</b> 1SNK 900 615 R0000	5	6.00

Some accessories may modify the terminal block's ratings. See complete information in "Technical Datasheet".

All the technical data for UL/CSA standard and dimensions in inches are in italic.



4 mm<sup>2</sup>  
10 AWG

# ZS4-S-R2 Screw Clamp Terminal Block

## Disconnect with Lever

6 mm 0.236 in spacing

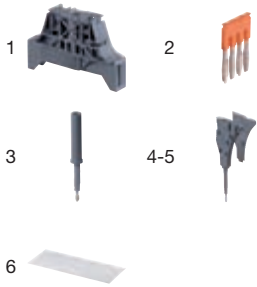
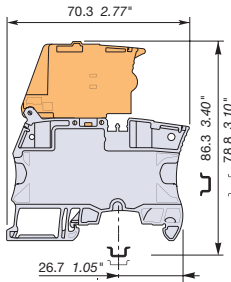

### Features and Benefits

Simplify the disconnect operations for the disconnect terminal blocks installed next to fuse terminal blocks ZS4-SF:  
- With the same profile as ZS4-SF, the ZS4-S-R2 disconnect lever is easily operated by hand and the wiring of the alternated disconnect and fuse circuits is easier.

### Main Technical Data

Connecting capacity	IEC	cULus - CSA
with 1 conductor per clamp	Rigid 0.2-4 mm <sup>2</sup>	24-10 AWG
	Flexible 0.22-4 mm <sup>2</sup>	24-10 AWG
	with ferrule 0.22-4 mm <sup>2</sup>	24-12 AWG
	Gauge A3-B3	
with 2 conductors per clamp	Rigid 0.2-1 mm <sup>2</sup>	24-18 AWG
	Flexible 0.22-1 mm <sup>2</sup>	24-18 AWG
	with twin ferrule 0.22-1.5 mm <sup>2</sup>	24-16 AWG
Maximum cross section	4 mm <sup>2</sup>	10 AWG
Max. current / Max. cross section	22 A	22 A
Maximum short circuit current (1s)	480 A	
Rated voltage	400 V	150 V
Impulse withstand voltage	6000 V	
Protection	IP 20	NEMA 1

### Mounting Instructions

Rail		DIN3-TH35
Wire stripping length		10.5 mm 0.413 in
Tool		Flat screwdriver Ø 3.5 mm Ø 0.138 in
Torque		0.6 Nm ± 0.1 5.31 lb.in ± 0.885

CE	RoHS	cULus	CSA	NEC	Gost	BV	Gost and BV: Pending - 2009
----	------	-------	-----	-----	------	----	-----------------------------

### Ordering Details

#### ZS4-S-R2 Disconnect Screw Clamp Terminal Block

Description	Type	Order Code	Pack <sup>(n)</sup> pieces	Weight g (1 pce)
Profile aligned with ZS4-SF	Grey-Orange	<b>ZS4-S-R2</b>	<b>1SNK 506 414 R0000</b>	50 21.60

### ZS4-S-R2 Terminal Block Accessories

1SNK 160 001 C0201

Description	Type	Order Code	Pack <sup>(n)</sup> pieces	Weight g (1 pce)
1 <b>End Stops</b>	10 mm 0.394 in Dark Grey	<b>BAM3</b>	<b>1SNK 900 001 R0000</b>	50 13.80
2 <b>Jumper Bars</b>	2 poles 41 A 30 A Orange	<b>JB6-2</b>	<b>1SNK 906 302 R0000</b>	50 1.30
	3 poles	<b>JB6-3</b>	<b>1SNK 906 303 R0000</b>	50 2.10
	4 poles	<b>JB6-4</b>	<b>1SNK 906 304 R0000</b>	50 2.90
	5 poles	<b>JB6-5</b>	<b>1SNK 906 305 R0000</b>	50 3.60
	10 poles	<b>JB6-10</b>	<b>1SNK 906 310 R0000</b>	20 7.40
3 <b>Test Adapters</b>	For test plugs DIA 2 mm 0.079 in Dark Grey	<b>TP2</b>	<b>1SNK 900 203 R0000</b>	20 1.73
	For test plugs DIA 4 mm 0.160 in	<b>TP4</b>	<b>1SNK 900 205 R0000</b>	20 2.42
4 <b>Test Connectors</b>	5.2 mm 0.205 in spacing Dark Grey	<b>TC5</b>	<b>1SNK 900 200 R0000</b>	10 5.23
	End module, 5.2 mm 0.205 in	<b>TC5-R1</b>	<b>1SNK 900 201 R0000</b>	10 5.23
5 <b>Spacers</b>	0.8 mm 0.031 in spacing Dark Grey	<b>ES-TC6</b>	<b>1SNK 900 105 R0000</b>	10 0.80
6 <b>Terminal Block Markers</b>	Blank card White	<b>MC612</b>	<b>1SNK 150 000 R0000</b>	22 0.06
	Universal wire markers holder Grey	<b>UMH</b>	<b>1SNK 900 611 R0000</b>	10 0.20
	Self adhesive strip White	<b>SAT6</b>	<b>1SNK 900 615 R0000</b>	5 6.00

Some accessories may modify the terminal block's ratings. See complete information in "Technical Datasheet".



### ZS4-SF Fuse Screw Clamp Terminal Block

1SNK 161 005 S0201

1SNK 161 005 D0201

Description	Type	Order Code	Pack <sup>(n)</sup> pieces	Weight g (1 pce)
<b>Fuse</b>	Grey-Dark Grey	<b>ZS4-SF</b>	<b>1SNK 506 410 R0000</b>	50 18.60

All the technical data for UL/CSA standard and dimensions in inches are in italic.

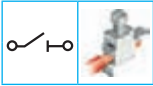

**4 mm<sup>2</sup>**  
**10 AWG**

# ZS4-S-R3 Screw Clamp Terminal Block

## Disconnect with Lever

8 mm 0.315 in spacing

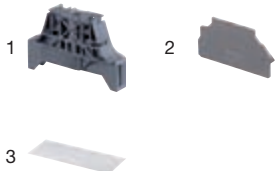
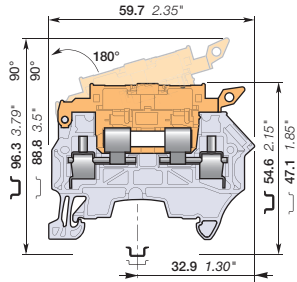

### Features and Benefits

Simplify the disconnect operations for the disconnect terminal blocks installed next to fuse terminal blocks ZS4-SF1:  
- With the same profile as ZS4-SF1, the ZS4-S-R3 disconnect lever is easily operated by hand and the wiring of the alternated disconnect and fuse circuits is easier.

### Main Technical Data

Connecting capacity	IEC	cULus - CSA
with 1 conductor per clamp	Rigid 0.2-4 mm <sup>2</sup>	24-10 AWG
	Flexible 0.22-4 mm <sup>2</sup>	24-10 AWG
	with ferrule 0.22-4 mm <sup>2</sup>	24-12 AWG
	Gauge A3-B3	
with 2 conductors per clamp	Rigid 0.2-1 mm <sup>2</sup>	24-18 AWG
	Flexible 0.22-1 mm <sup>2</sup>	24-18 AWG
	with twin ferrule 0.22-1.5 mm <sup>2</sup>	24-16 AWG
Maximum cross section	4 mm <sup>2</sup>	10 AWG
Max. current / Max. cross section	22 A	22 A
Maximum short circuit current (1s)	480 A	
Rated voltage	500 V	300 V
Impulse withstand voltage	8000 V	
Protection	IP 20	NEMA 1

### Mounting Instructions

Rail		DIN3-TH35
Wire stripping length		11 mm 0.433 in
Tool		Flat screwdriver Ø 3.5 mm Ø 0.138 in
Torque		0.6 Nm ± 0.1 5.31 lb.in ± 0.885

CE	RoHS	UL	CSA	RoHS	Gost	BV	Gost and BV: Pending - 2009
----	------	----	-----	------	------	----	-----------------------------

### Ordering Details

#### ZS4-S-R3 Disconnect Screw Clamp Terminal Block

Description	Type	Order Code	Pack <sup>(ing)</sup> pieces	Weight g (1 pce)
Profile aligned with ZS4-SF1	Grey-Orange	<b>ZS4-S-R3</b>	<b>1SNK 508 416 R0000</b>	50 13.30

#### ZS4-S-R3 Terminal Block Accessories

1SNK 160 001 C0201

Description	Type	Order Code	Pack <sup>(ing)</sup> pieces	Weight g (1 pce)
1 <b>End Stops</b>	10 mm 0.394 in Dark Grey	<b>BAM3</b>	<b>1SNK 900 001 R0000</b>	50 13.80
2 <b>End Sections</b>	1.5 mm 0.059 in Dark Grey	<b>ES4-SF</b>	<b>1SNK 508 960 R0000</b>	20 1.82
3 <b>Terminal Block Markers</b>	Blank card White	<b>MC812</b>	<b>1SNK 160 000 R0000</b>	22 0.09
	Universal wire markers holder Grey	<b>UMH</b>	<b>1SNK 900 611 R0000</b>	10 0.20
	Self adhesive strip White	<b>SAT8</b>	<b>1SNK 900 616 R0000</b>	5 6.00

Some accessories may modify the terminal block's ratings. See complete information in "Technical Datasheet".

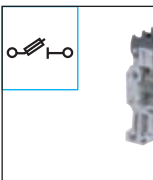

### ZS4-SF1 Fuse Screw Clamp Terminal Block

1SNK 161 011 S0201

1SNK 161 011 D0201

Description	Type	Order Code	Pack <sup>(ing)</sup> pieces	Weight g (1 pce)
<b>Fuse</b>	Grey-Dark Grey	<b>ZS4-SF1</b>	<b>1SNK 508 410 R0000</b>	50 13.30

All the technical data for UL/CSA standard and dimensions in inches are in italic.





4 mm<sup>2</sup>  
10 AWG

# ZS4-SF Screw Clamp Terminal Block

## for 5x20 Fuses

6 mm 0.236 in spacing

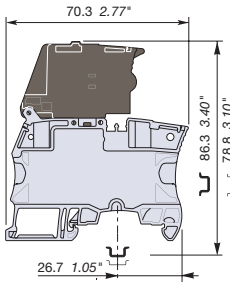
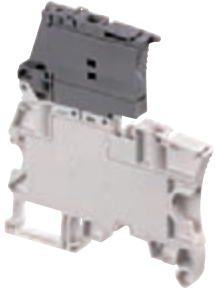

### Features and Benefits

- Protect your circuits with 5x20 fuse terminal blocks compliant with IEC 60947-7-3 standard (fuse not supplied with the terminal blocks),
- Simplify the distribution thanks to the two jumper channels aligned with ZS4 feed-through and ZS4-S-R1 disconnect terminal blocks.

### Main Technical Data

Connecting capacity	IEC	cULus - CSA
with 1 conductor per clamp	Rigid 0.2-4 mm <sup>2</sup>	24-10 AWG
	Flexible 0.22-4 mm <sup>2</sup>	24-10 AWG
	with ferrule 0.22-4 mm <sup>2</sup>	24-12 AWG
Gauge A3-B3		
with 2 conductors per clamp	Rigid 0.2-1 mm <sup>2</sup>	24-18 AWG
	Flexible 0.22-1 mm <sup>2</sup>	24-18 AWG
	with twin ferrule 0.22-1.5 mm <sup>2</sup>	24-16 AWG
Rated cross section	4 mm <sup>2</sup>	10 AWG
Rated current	6.3 A	6.3 A
Rated short-time withstand current (1s)	480 A	
Rated voltage	250 V	150 V
Impulse withstand voltage	6000 V	
Protection	IP 20	NEMA 1

### Rated power

Separate arrangement/Overload and short-circuit arrangement	2.5 W
Separate arrangement/Exclusive short-circuit arrangement	4 W
Compound arrangement/Overload and short-circuit arrangement	2.5 W
Compound arrangement/Exclusive short-circuit arrangement	4 W

CE	CB	RoHS	cULus	CSA	PCB	Gost	BV	Gost and BV: Pending - 2009
----	----	------	-------	-----	-----	------	----	-----------------------------

### Ordering Details

#### ZS4-SF Fuse Screw Clamp Terminal Block

Description	Type	Order Code	Pack <sup>(ng)</sup> pieces	Weight g (1 pce)
Grey-Dark Grey	ZS4-SF	1SNK 506 410 R0000	50	18.60

#### ZS4-SF Terminal Block Accessories

1SNK 160 001 C0201

Description	Type	Order Code	Pack <sup>(ng)</sup> pieces	Weight g (1 pce)
1 End Stops	10 mm 0.394 in Dark Grey	BAM3 1SNK 900 001 R0000	50	13.80
2 Jumper Bars	2 poles 41 A 30 A Orange	JB6-2 1SNK 906 302 R0000	50	1.30
	3 poles	JB6-3 1SNK 906 303 R0000	50	2.10
	4 poles	JB6-4 1SNK 906 304 R0000	50	2.90
	5 poles	JB6-5 1SNK 906 305 R0000	50	3.60
	10 poles	JB6-10 1SNK 906 310 R0000	20	7.40
3 Test Adapters	For test plugs DIA 2 mm 0.079 in Dark Grey	TP2 1SNK 900 203 R0000	20	1.73
	For test plugs DIA 4 mm 0.160 in	TP4 1SNK 900 205 R0000	20	2.42
4 Test Connectors	5.2 mm 0.205 in spacing Dark Grey	TC5 1SNK 900 200 R0000	10	5.23
	End module, 5.2 mm 0.205 in	TC5-R1 1SNK 900 201 R0000	10	5.23
5 Spacers	0.8 mm 0.031 in spacing Dark Grey	ES-TC6 1SNK 900 105 R0000	10	0.80
6 Terminal Block Markers	Blank card White	MC612 1SNK 150 000 R0000	22	0.06
	Universal wire markers holder Grey	UMH 1SNK 900 611 R0000	10	0.20
	Self adhesive strip White	SAT6 1SNK 900 615 R0000	5	6.00

Some accessories may modify the terminal block's ratings. See complete information in "Technical Datasheet".

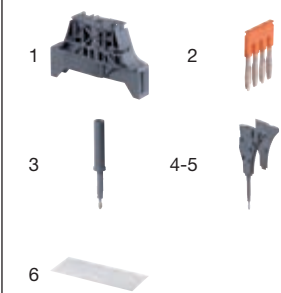



**4 mm<sup>2</sup>**  
**10 AWG**

# ZS4-SF-T Screw Clamp Terminal Block

## for 5x20 Fuses - with Test Socket Screws

6 mm 0.236 in spacing

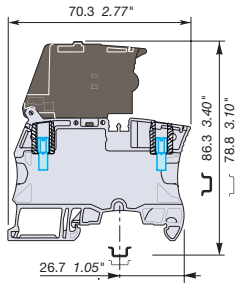

### Features and Benefits

- Protect your circuits with 5x20 fuse terminal blocks compliant with IEC 60947-7-3 standard (fuse not supplied with the terminal blocks),
- Simplify the distribution thanks to the two jumper channels aligned with ZS4 Feed-through and ZS4-S-R1 disconnect terminal blocks,
- Ease the test with built-in test socket screws.

### Main Technical Data

Connecting capacity	IEC	cULus - CSA
with 1 conductor per clamp	Rigid	0.2-4 mm <sup>2</sup>
	Flexible	0.22-4 mm <sup>2</sup>
	with ferrule	0.22-4 mm <sup>2</sup>
	Gauge	A3-B3
with 2 conductors per clamp	Rigid	0.2-1 mm <sup>2</sup>
	Flexible	0.22-1 mm <sup>2</sup>
	with twin ferrule	0.22-1.5 mm <sup>2</sup>
Rated cross section	4 mm <sup>2</sup>	10 AWG
Rated current	6.3 A	6.3 A
Rated short-time withstand current (1s)	480 A	
Rated voltage	250 V	150 V
Impulse withstand voltage	6000 V	
Protection	IP 20	NEMA 1

### Mounting Instructions

Rail		DIN3-TH35
Wire stripping length		10.5 mm 0.413 in
Tool		Flat screwdriver Ø 3.5 mm Ø 0.138 in
Torque		0.6 Nm ± 0.1 5.31 lb.in ± 0.885

### Rated power

Separate arrangement/Overload and short-circuit arrangement	2.5 W
Separate arrangement/Exclusive short-circuit arrangement	4 W
Compound arrangement/Overload and short-circuit arrangement	2.5 W
Compound arrangement/Exclusive short-circuit arrangement	4 W

CE CB RoHS cUL CSA Gost BV	Gost and BV: Pending - 2009
--	-----------------------------

### Ordering Details

#### ZS4-SF-T Fuse Screw Clamp Terminal Block

Description	Type	Order Code	Pack <sup>(ing)</sup> pieces	Weight g (1 pce)
With 2 test socket screws DIA 2 mm 0.079 in Grey-Dark Grey		<b>ZS4-SF-T2</b>	<b>1SNK 506 411 R0000</b>	50 18.60

#### ZS4-SF-T Terminal Block Accessories

1SNK 160 001 C0201

Description	Type	Order Code	Pack <sup>(ing)</sup> pieces	Weight g (1 pce)
1 <b>End Stops</b> 10 mm 0.394 in Dark Grey		<b>BAM3</b>	<b>1SNK 900 001 R0000</b>	50 13.80
2 <b>Jumper Bars</b> 2 poles 41 A 30 A Orange		<b>JB6-2</b>	<b>1SNK 906 302 R0000</b>	50 1.30
		<b>JB6-3</b>	<b>1SNK 906 303 R0000</b>	50 2.10
		<b>JB6-4</b>	<b>1SNK 906 304 R0000</b>	50 2.90
		<b>JB6-5</b>	<b>1SNK 906 305 R0000</b>	50 3.60
		<b>JB6-10</b>	<b>1SNK 906 310 R0000</b>	20 7.40
3 <b>Test Connectors</b> 5.2 mm 0.205 in spacing Dark Grey		<b>TC5</b>	<b>1SNK 900 200 R0000</b>	10 5.23
		<b>TC5-R1</b>	<b>1SNK 900 201 R0000</b>	10 5.23
4 <b>Spacers</b> 0.8 mm 0.031 in spacing Dark Grey		<b>ES-TC6</b>	<b>1SNK 900 105 R0000</b>	10 0.80
5 <b>Terminal Block Markers</b>		<b>MC612</b>	<b>1SNK 150 000 R0000</b>	22 0.06
		<b>UMH</b>	<b>1SNK 900 611 R0000</b>	10 0.20
		<b>SAT6</b>	<b>1SNK 900 615 R0000</b>	5 6.00

Some accessories may modify the terminal block's ratings. See complete information in "Technical Datasheet".

All the technical data for UL/CSA standard and dimensions in inches are in italic.



4 mm<sup>2</sup>  
10 AWG

# ZS4-SF-R Screw Clamp Terminal Block

## for 5x20 Fuses - with Blown Fuse Indicator

6 mm 0.236 in spacing

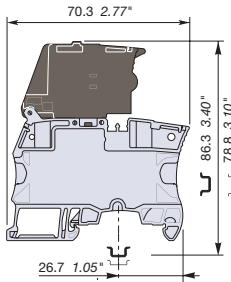

### Features and Benefits

- Protect your circuits with 5x20 fuse terminal blocks compliant with IEC 60947-7-3 standard (fuse not supplied with the terminal blocks),
- Simplify the distribution thanks to the two jumper channels aligned with ZS4 feed-through and ZS4-S-R1 disconnect terminal blocks,
- Quickly identify the defective circuit thanks to the blown fuse indicator with leakage current < 0.5 mA.

### Main Technical Data

Connecting capacity	IEC	cULus - CSA
with 1 conductor per clamp	Rigid 0.2-4 mm <sup>2</sup>	24-10 AWG
	Flexible 0.22-4 mm <sup>2</sup>	24-10 AWG
	with ferrule 0.22-4 mm <sup>2</sup>	24-12 AWG
	Gauge A3-B3	
with 2 conductors per clamp	Rigid 0.2-1 mm <sup>2</sup>	24-18 AWG
	Flexible 0.22-1 mm <sup>2</sup>	24-18 AWG
	with twin ferrule 0.22-1.5 mm <sup>2</sup>	24-16 AWG
Rated cross section	4 mm <sup>2</sup>	10 AWG
Rated current	6.3 A	6.3 A
Rated short-time withstand current (1s)	480 A	
Rated voltage	250 V	150 V
Impulse withstand voltage	6000 V	
Protection	IP 20	NEMA 1

### Mounting Instructions

Rail		DIN3-TH35
Wire stripping length		10.5 mm 0.413 in
Tool		Flat screwdriver Ø 3.5 mm Ø 0.138 in
Torque		0.6 Nm ± 0.1 5.31 lb.in ± 0.885

### Rated power

Separate arrangement/Overload and short-circuit arrangement	2.5 W
Separate arrangement/Exclusive short-circuit arrangement	4 W
Compound arrangement/Overload and short-circuit arrangement	2.5 W
Compound arrangement/Exclusive short-circuit arrangement	4 W



Gost and BV: Pending - 2009

### Ordering Details

#### ZS4-SF-R Fuse Screw Clamp Terminal Block

Description	Type	Order Code	Pack <sup>(ng)</sup> pieces	Weight g (1 pce)
With blown fuse indicator by red LED 24-60V Grey-Dark Grey		<b>ZS4-SF-R1</b> 1SNK 506 412 R0000	50	18.60
With blown fuse indicator by red LED 115-250V Grey-Dark Grey		<b>ZS4-SF-R3</b> 1SNK 506 415 R0000	50	18.60

#### ZS4-SF-R Terminal Block Accessories

1SNK 160 001 C0201

Description	Type	Order Code	Pack <sup>(ng)</sup> pieces	Weight g (1 pce)
1 <b>End Stops</b> 10 mm 0.394 in Dark Grey		<b>BAM3</b> 1SNK 900 001 R0000	50	13.80
2 <b>Jumper Bars</b> 2 poles 41 A 30 A Orange		<b>JB6-2</b> 1SNK 906 302 R0000	50	1.30
		<b>JB6-3</b> 1SNK 906 303 R0000	50	2.10
		<b>JB6-4</b> 1SNK 906 304 R0000	50	2.90
		<b>JB6-5</b> 1SNK 906 305 R0000	50	3.60
		<b>JB6-10</b> 1SNK 906 310 R0000	20	7.40
3 <b>Test Adapters</b> For test plugs DIA 2 mm 0.079 in Dark Grey		<b>TP2</b> 1SNK 900 203 R0000	20	1.73
		<b>TP4</b> 1SNK 900 205 R0000	20	2.42
4 <b>Test Connectors</b> 5.2 mm 0.205 in spacing Dark Grey		<b>TC5</b> 1SNK 900 200 R0000	10	5.23
		<b>TC5-R1</b> 1SNK 900 201 R0000	10	5.23
5 <b>Spacers</b> 0.8 mm 0.031 in spacing Dark Grey		<b>ES-TC6</b> 1SNK 900 105 R0000	10	0.80
6 <b>Terminal Block Markers</b>		<b>MC612</b> 1SNK 150 000 R0000	22	0.06
		<b>UMH</b> 1SNK 900 611 R0000	10	0.20
		<b>SAT6</b> 1SNK 900 615 R0000	5	6.00

Some accessories may modify the terminal block's ratings. See complete information in "Technical Datasheet".

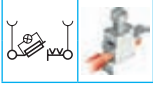

**4 mm<sup>2</sup>**  
**10 AWG**

# ZS4-SF-R Screw Clamp Terminal Block

for 5x20 Fuses - with Blown Fuse Indicator and Test Socket Screws

6 mm 0.236 in spacing

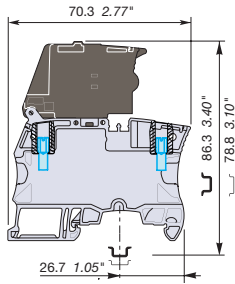
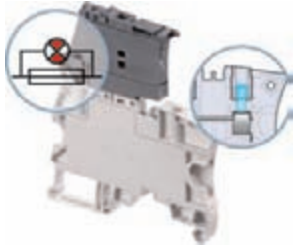

## Features and Benefits

- Protect your circuits with 5x20 fuse terminal blocks compliant with IEC 60947-7-3 standard (fuse not supplied with the terminal blocks),
- Simplify the distribution thanks to the two jumper channels aligned with ZS4 feed-through and ZS4-S-R1 disconnect terminal blocks,
- Ease the test with built-in test socket screws,
- Quickly identify the defective circuit thanks to the blown fuse indicator with leakage current < 0.5 mA.

## Main Technical Data

Connecting capacity	IEC	cULus - CSA
with 1 conductor per clamp	Rigid	0.2-4 mm <sup>2</sup>
	Flexible	0.22-4 mm <sup>2</sup>
	with ferrule	0.22-4 mm <sup>2</sup>
	Gauge	A3-B3
with 2 conductors per clamp	Rigid	0.2-1 mm <sup>2</sup>
	Flexible	0.22-1 mm <sup>2</sup>
	with twin ferrule	0.22-1.5 mm <sup>2</sup>
Rated cross section	4 mm <sup>2</sup>	10 AWG
Rated current	6.3 A	6.3 A
Rated short-time withstand current (1s)	480 A	
Rated voltage	250 V	150 V
Impulse withstand voltage	6000 V	
Protection	IP 20	NEMA 1

## Mounting Instructions

Rail		DIN3-TH35
Wire stripping length		10.5 mm 0.413 in
Tool		Flat screwdriver Ø 3.5 mm Ø 0.138 in
Torque		0.6 Nm ± 0.1 5.31 lb.in ± 0.885

## Rated power

Separate arrangement/Overload and short-circuit arrangement	2.5 W
Separate arrangement/Exclusive short-circuit arrangement	4 W
Compound arrangement/Overload and short-circuit arrangement	2.5 W
Compound arrangement/Exclusive short-circuit arrangement	4 W

							Gost and BV: Pending - 2009
--	--	--	--	--	--	--	-----------------------------

## Ordering Details

### ZS4-SF-R Fuse Screw Clamp Terminal Block

Description	Type	Order Code	Pack <sup>(ing)</sup> pieces	Weight g (1 pce)
With blown fuse indicator by red LED 24-60V and 2 test socket screws DIA 2 mm 0.079 in	Grey-Dark Grey	<b>ZS4-SF-R2</b> 1SNK 506 413 R0000	50	18.60
With blown fuse indicator by red LED 115-250V and 2 test socket screws DIA 2 mm 0.079 in	Grey-Dark Grey	<b>ZS4-SF-R4</b> 1SNK 506 416 R0000	50	18.60

### ZS4-SF-R Terminal Block Accessories

1SNK 160 001 C0201

Description	Type	Order Code	Pack <sup>(ing)</sup> pieces	Weight g (1 pce)
1 <b>End Stops</b> 10 mm 0.394 in	Dark Grey	<b>BAM3</b> 1SNK 900 001 R0000	50	13.80
2 <b>Jumper Bars</b> 2 poles 41 A 30 A	Orange	<b>JB6-2</b> 1SNK 906 302 R0000	50	1.30
3 poles		<b>JB6-3</b> 1SNK 906 303 R0000	50	2.10
4 poles		<b>JB6-4</b> 1SNK 906 304 R0000	50	2.90
5 poles		<b>JB6-5</b> 1SNK 906 305 R0000	50	3.60
10 poles		<b>JB6-10</b> 1SNK 906 310 R0000	20	7.40
3 <b>Test Connectors</b> 5.2 mm 0.205 in spacing	Dark Grey	<b>TC5</b> 1SNK 900 200 R0000	10	5.23
End module, 5.2 mm 0.205 in		<b>TC5-R1</b> 1SNK 900 201 R0000	10	5.23
4 <b>Spacers</b> 0.8 mm 0.031 in spacing	Dark Grey	<b>ES-TC6</b> 1SNK 900 105 R0000	10	0.80
5 <b>Terminal Block Markers</b> Blank card	White	<b>MC612</b> 1SNK 150 000 R0000	22	0.06
Universal wire markers holder	Grey	<b>UMH</b> 1SNK 900 611 R0000	10	0.20
Self adhesive strip	White	<b>SAT6</b> 1SNK 900 615 R0000	5	6.00

Some accessories may modify the terminal block's ratings. See complete information in "Technical Datasheet".

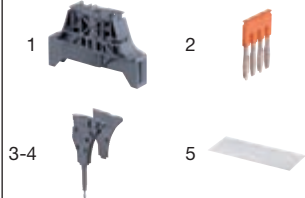

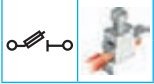

**4 mm<sup>2</sup>**  
**10 AWG**

# ZS4-SF1 Screw Clamp Terminal Block

for 5x20 and 5x25 Fuses

**8 mm 0.315 in spacing**

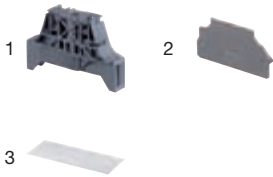
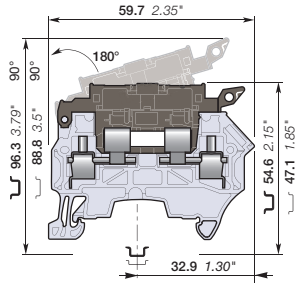

### Features and Benefits

- Protect your circuit with 5x25 and 5x20 fuse terminal blocks, compliant with IEC 60947-7-3 standard (fuse not supplied with the terminal blocks).

### Main Technical Data

Connecting capacity	IEC	cULus - CSA
with 1 conductor per clamp	Rigid	0.2-4 mm <sup>2</sup>
	Flexible	0.22-4 mm <sup>2</sup>
	with ferrule	0.22-4 mm <sup>2</sup>
	Gauge	A3-B3
with 2 conductors per clamp	Rigid	0.2-1 mm <sup>2</sup>
	Flexible	0.22-1 mm <sup>2</sup>
	with twin ferrule	0.22-1.5 mm <sup>2</sup>
	Gauge	A3-B3
Rated cross section	4 mm <sup>2</sup>	10 AWG
Rated current	6.3 A	6.3 A
Rated short-time withstand current (1s)	480 A	
Rated voltage	250 V	300 V
Impulse withstand voltage	8000 V	
Protection	IP 20	NEMA 1

### Rated power

Separate arrangement/Overload and short-circuit arrangement	2.5 W
Separate arrangement/Exclusive short-circuit arrangement	4 W
Compound arrangement/Overload and short-circuit arrangement	1.6 W
Compound arrangement/Exclusive short-circuit arrangement	4 W

CE	CB	RoHS	cULus	CSA	Gost	BV	Gost and BV: Pending - 2009
----	----	------	-------	-----	------	----	-----------------------------

### Ordering Details

#### ZS4-SF1 Fuse Screw Clamp Terminal Block

Description	Type	Order Code	Pack <sup>(ing)</sup> pieces	Weight g (1 pce)
Grey-Dark Grey	<input checked="" type="checkbox"/>	<b>ZS4-SF1</b>	<b>1SNK 508 410 R0000</b>	50 13.30

#### ZS4-SF1 Terminal Block Accessories

1SNK 160 001 C0201

Description	Type	Order Code	Pack <sup>(ing)</sup> pieces	Weight g (1 pce)
1 <b>End Stops</b>	10 mm 0.394 in	Dark Grey <input checked="" type="checkbox"/> <b>BAM3</b>	<b>1SNK 900 001 R0000</b>	50 13.80
2 <b>End Sections</b>	1.5 mm 0.059 in	Dark Grey <input checked="" type="checkbox"/> <b>ES4-SF</b>	<b>1SNK 508 960 R0000</b>	20 1.82
3 <b>Terminal Block Markers</b>	Blank card	White <input type="checkbox"/> <b>MC812</b>	<b>1SNK 160 000 R0000</b>	22 0.09
	Universal wire markers holder	Grey <input type="checkbox"/> <b>UMH</b>	<b>1SNK 900 611 R0000</b>	10 0.20
	Self adhesive strip	White <input type="checkbox"/> <b>SAT8</b>	<b>1SNK 900 616 R0000</b>	5 6.00

Some accessories may modify the terminal block's ratings. See complete information in "Technical Datasheet".



**4 mm<sup>2</sup>**  
**10 AWG**

# ZS4-SF1-T Screw Clamp Terminal Block

for 5x20 and 5x25 Fuses - with Test Socket Screws

8 mm 0.315 in spacing

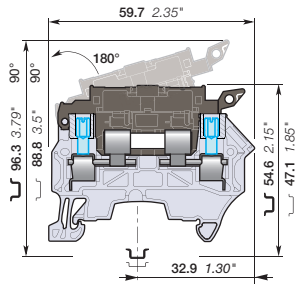
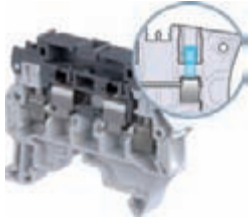

## Features and Benefits

- Protect your circuit with 5x25 and 5x20 fuse terminal blocks (fuse not supplied with the terminal blocks),
- Compliant with IEC 60947-7-3 standard,
- With built in test socket screws.

## Main Technical Data

Connecting capacity	IEC	cULus - CSA
with 1 conductor per clamp	Rigid	0.2-4 mm <sup>2</sup>
	Flexible	0.22-4 mm <sup>2</sup>
	with ferrule	0.22-4 mm <sup>2</sup>
	Gauge	A3-B3
with 2 conductors per clamp	Rigid	0.2-1 mm <sup>2</sup>
	Flexible	0.22-1 mm <sup>2</sup>
	with twin ferrule	0.22-1.5 mm <sup>2</sup>
Rated cross section	4 mm <sup>2</sup>	10 AWG
Rated current	6.3 A	6.3 A
Rated short-time withstand current (1s)	480 A	
Rated voltage	250 V	300 V
Impulse withstand voltage	8000 V	
Protection	IP 20	NEMA 1

## Mounting Instructions

Rail		DIN3-TH35
Wire stripping length		11 mm 0.433 in
Tool		Flat screwdriver Ø 3.5 mm Ø 0.138 in
Torque		0.6 Nm ± 0.1 5.31 lb.in ± 0.885

## Rated power

Separate arrangement/Overload and short-circuit arrangement	2.5 W
Separate arrangement/Exclusive short-circuit arrangement	4 W
Compound arrangement/Overload and short-circuit arrangement	1.6 W
Compound arrangement/Exclusive short-circuit arrangement	4 W

CE CB RoHS cUL CSA Gost	Gost and BV: Pending - 2009
--	-----------------------------

## Ordering Details

### ZS4-SF1-T Fuse Screw Clamp Terminal Block

Description	Type	Order Code	Pack <sup>(ing)</sup> pieces	Weight g (1 pce)
With 2 test socket screws DIA 2 mm 0.079 in	Grey-Dark Grey	<b>ZS4-SF1-T2</b>	<b>1SNK 508 411 R0000</b>	50 13.30

### ZS4-SF1-T Terminal Block Accessories

1SNK 160 001 C0201

Description	Type	Order Code	Pack <sup>(ing)</sup> pieces	Weight g (1 pce)
1 <b>End Stops</b> 10 mm 0.394 in	Dark Grey	<b>BAM3</b>	50	13.80
2 <b>End Sections</b> 1.5 mm 0.059 in	Dark Grey	<b>ES4-SF</b>	20	1.82
3 <b>Terminal Block Markers</b>				
Blank card	White	<b>MC812</b>	22	0.09
Universal wire markers holder	Grey	<b>UMH</b>	10	0.20
Self adhesive strip	White	<b>SAT8</b>	5	6.00

Some accessories may modify the terminal block's ratings. See complete information in "Technical Datasheet".

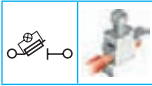

4 mm<sup>2</sup>  
10 AWG

## ZS4-SF1-R Screw Clamp Terminal Block

for 5x20 and 5x25 Fuses - with Blown Fuse Indicator

8 mm 0.315 in spacing

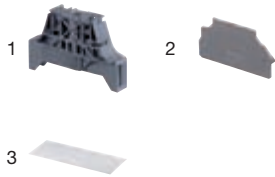
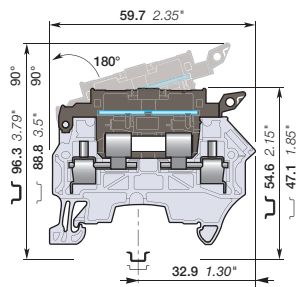
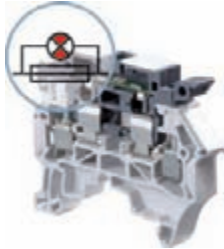

### Features and Benefits

- Protect your circuit with 5x25 and 5x20 fuse terminal blocks (fuse not supplied with the terminal blocks),
- Compliant with IEC 60947-7-3 standard,
- Quickly identify the defective circuit thanks to the blown fuse indicator with leakage current < 0.5 mA.

### Main Technical Data

Connecting capacity	IEC	cULus - CSA
with 1 conductor per clamp	Rigid 0.2-4 mm <sup>2</sup>	24-10 AWG
	Flexible 0.22-4 mm <sup>2</sup>	24-10 AWG
	with ferrule 0.22-4 mm <sup>2</sup>	24-12 AWG
Gauge A3-B3		
with 2 conductors per clamp	Rigid 0.2-1 mm <sup>2</sup>	24-18 AWG
	Flexible 0.22-1 mm <sup>2</sup>	24-18 AWG
	with twin ferrule 0.22-1.5 mm <sup>2</sup>	24-16 AWG
Rated cross section	4 mm <sup>2</sup>	10 AWG
Rated current	6.3 A	6.3 A
Rated short-time withstand current (1s)	480 A	
Rated voltage	250 V	300 V
Impulse withstand voltage	8000 V	
Protection	IP 20	NEMA 1

### Mounting Instructions

Rail		DIN3-TH35
Wire stripping length		11 mm 0.433 in
Tool		Flat screwdriver Ø 3.5 mm Ø 0.138 in
Torque		0.6 Nm ± 0.1 5.31 lb.in ± 0.885

### Rated power

Separate arrangement/Overload and short-circuit arrangement	2.5 W
Separate arrangement/Exclusive short-circuit arrangement	4 W
Compound arrangement/Overload and short-circuit arrangement	1.6 W
Compound arrangement/Exclusive short-circuit arrangement	4 W



Gost and BV: Pending - 2009

### Ordering Details

#### ZS4-SF1-R Fuse Screw Clamp Terminal Block

Description	Type	Order Code	Pack <sup>(ing)</sup> pieces	Weight g (1 pce)
With blown fuse indicator by red LED 24-60V	Grey-Dark Grey	<b>ZS4-SF1-R1</b>	50	13.30
With blown fuse indicator by red LED 115-250V	Grey-Dark Grey	<b>ZS4-SF1-R3</b>	50	13.30

#### ZS4-SF1-R Terminal Block Accessories

1SNK 160 001 C0201

Description	Type	Order Code	Pack <sup>(ing)</sup> pieces	Weight g (1 pce)
1 <b>End Stops</b>	10 mm 0.394 in	Dark Grey <b>BAM3</b>	50	13.80
2 <b>End Sections</b>	1.5 mm 0.059 in	Dark Grey <b>ES4-SF</b>	20	1.82
3 <b>Terminal Block Markers</b>	Blank card	White <b>MC812</b>	22	0.09
	Universal wire markers holder	Grey <b>UMH</b>	10	0.20
	Self adhesive strip	White <b>SAT8</b>	5	6.00

Some accessories may modify the terminal block's ratings. See complete information in "Technical Datasheet".

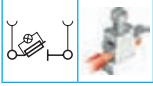

**4 mm<sup>2</sup>**  
**10 AWG**

# ZS4-SF1-R Screw Clamp Terminal Block

for 5x20 and 5x25 Fuses - with Blown Fuse Indicator and Test Socket Screws

8 mm 0.315 in spacing

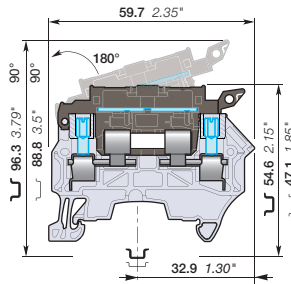
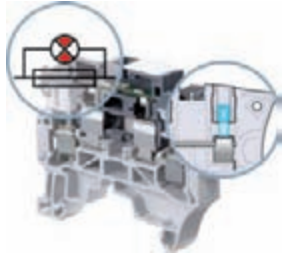

## Features and Benefits

- Protect your circuit with 5x25 and 5x20 fuse terminal blocks (fuse not supplied with the terminal blocks),
- Compliant with IEC 60947-7-3 standard,
- Ease the test with built-in test socket screws,
- Quickly identify the defective circuit thanks to the blown fuse indicator with leakage current < 0.5 mA.

## Main Technical Data

Connecting capacity	IEC	cULus - CSA
with 1 conductor per clamp	Rigid	0.2-4 mm <sup>2</sup>
	Flexible	0.22-4 mm <sup>2</sup>
	with ferrule	0.22-4 mm <sup>2</sup>
	Gauge	A3-B3
with 2 conductors per clamp	Rigid	0.2-1 mm <sup>2</sup>
	Flexible	0.22-1 mm <sup>2</sup>
	with twin ferrule	0.22-1.5 mm <sup>2</sup>
Rated cross section	4 mm <sup>2</sup>	10 AWG
Rated current	6.3 A	6.3 A
Rated short-time withstand current (1s)	480 A	
Rated voltage	250 V	300 V
Impulse withstand voltage	8000 V	
Protection	IP 20	NEMA 1

## Mounting Instructions

Rail		DIN3-TH35
Wire stripping length		11 mm 0.433 in
Tool		Flat screwdriver Ø 3.5 mm Ø 0.138 in
Torque		0.6 Nm ± 0.1 5.31 lb.in ± 0.885

## Rated power

Separate arrangement/Overload and short-circuit arrangement	2.5 W
Separate arrangement/Exclusive short-circuit arrangement	4 W
Compound arrangement/Overload and short-circuit arrangement	1.6 W
Compound arrangement/Exclusive short-circuit arrangement	4 W



Gost and BV: Pending - 2009

## Ordering Details

### ZS4-SF1-R Fuse Screw Clamp Terminal Block

Description	Type	Order Code	Pack <sup>(ing)</sup> pieces	Weight g (1 pce)
With blown fuse indicator by red LED 24-60V and 2 test socket screws DIA 2 mm 0.079 in	Grey-Dark Grey	<b>ZS4-SF1-R2</b> 1SNK 508 413 R0000	50	13.30
With blown fuse indicator by red LED 115-250V and 2 test socket screws DIA 2 mm 0.079 in	Grey-Dark Grey	<b>ZS4-SF1-R4</b> 1SNK 508 415 R0000	50	13.30

### ZS4-SF1-R Terminal Block Accessories

1SNK 160 001 C0201

Description	Type	Order Code	Pack <sup>(ing)</sup> pieces	Weight g (1 pce)
1 <b>End Stops</b> 10 mm 0.394 in	Dark Grey	<b>BAM3</b> 1SNK 900 001 R0000	50	13.80
2 <b>End Sections</b> 1.5 mm 0.059 in	Dark Grey	<b>ES4-SF</b> 1SNK 508 960 R0000	20	1.82
3 <b>Terminal Block Markers</b>				
Blank card	White	<b>MC812</b> 1SNK 160 000 R0000	22	0.09
Universal wire markers holder	Grey	<b>UMH</b> 1SNK 900 611 R0000	10	0.20
Self adhesive strip	White	<b>SAT8</b> 1SNK 900 616 R0000	5	6.00

Some accessories may modify the terminal block's ratings. See complete information in "Technical Datasheet".

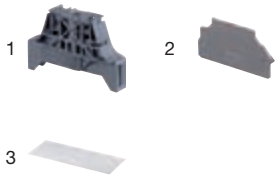



## **X-ON Electronics**

Largest Supplier of Electrical and Electronic Components

*Click to view similar products for [entrelec](#) manufacturer:*

Other Similar products are found below :

[023103024](#) [023000107](#) [1SNK505310R0000](#) [017322627](#) [011762822](#) [016511417](#) [016340320](#) [1SNK516020R0000](#) [023300421](#)

[1SNK510010R0000](#) [018731214](#) [011870703](#) [010500220](#) [011511607](#) [023300227](#) [016049626](#) [017666704](#) [1SNK508411R0000](#) [023300320](#)

[016548827](#) [023300001](#) [012511813](#) [017301610](#) [011546820](#)