



Piezo Haptic Actuators - PowerHap

Actuators with Adjustable Haptic Feedback

Series/Type: 0909H011V060
Ordering code: B54103H2020A001
Date: 2019-04-17
Version: 10

Features

- Large displacement
- High acceleration
- High force
- Low insertion height
- Fast response time
- Integrated sensor functionality

Design

- RoHS-compatible PZT (lead zirconium titanate) ceramic
- Copper inner electrodes
- Dimension of ceramic body: 9 x 9 x 0.55 mm
- Titanium cymbals for displacement amplification
- Previously known as PowerHap™ 2.5G
- Contains SVHC substance 12626-81-2

General technical data

Parameter	Ratings
Operating voltage range	-10 ... 60 V
Operating temperature powered	-40 °C ... +85 °C
Operating temperature unpowered	-40 °C ... +125 °C
Maximum compressive force on actuator	10 N
Maximum operation frequency	The operation frequency is limited by self-heating of the device. The self-heating of device should not exceed by +30 °C. At 60 V, 500 Hz, square wave conditions, a maximum allowable temperature increase of +30 °C is observed after about 10 s of operation.
Maximum voltage gradient	0.6 MV/s

Electrical characteristics at 25 °C

Parameter	Conditions	Expected value (typ.)
Capacitance	C 1 kHz, 1 V _{RMS}	0.85 µF
Displacement	s 0 ... 60 V, measured at cymbal end-caps	35 µm
Loading charge	Q 0 ... 60 V	0.09 mC

Further typical electrical characteristics as a design reference for haptic applications at 25 °C¹⁾

Parameter		Conditions	Typical
1 st Resonance frequency	f_R	0.5 V _{RMS}	45 kHz
Stiffness	k	60 V various load stiffness; preload 5 N	80 N/mm
Acceleration unipolar ²⁾ (see Fig. 5.)	a	20 g, single pulse sine wave, 200 Hz, 0 ... 60 V	5 · g (peak to peak) 2.5 · g (peak)
		100 g, single pulse sine wave, 200 Hz, 0 ... 60 V	5.2 · g (peak to peak) 2.5 · g (peak)
		200 g, single pulse sine wave, 200 Hz, 0 ... 60 V	3 · g (peak to peak) 1.5 · g (peak)
Acceleration bipolar ²⁾ (see Fig. 6.)	a	20 g, single pulse sine wave, 200 Hz, -10 ... 10 V	4.5 · g (peak to peak) 2 · g (peak)
		100 g, single pulse sine wave, 200 Hz, -10 ... 10 V	1.5 · g (peak to peak) 0.8 · g (peak)

¹⁾ Characterization performed with the support of AddHaptics Inc.

²⁾ g is unit of measure of acceleration. 1 g is the acceleration due to gravity at the earth's surface $1 \cdot g = 9.81 \text{ m/s}^2$.

Dimensional drawings

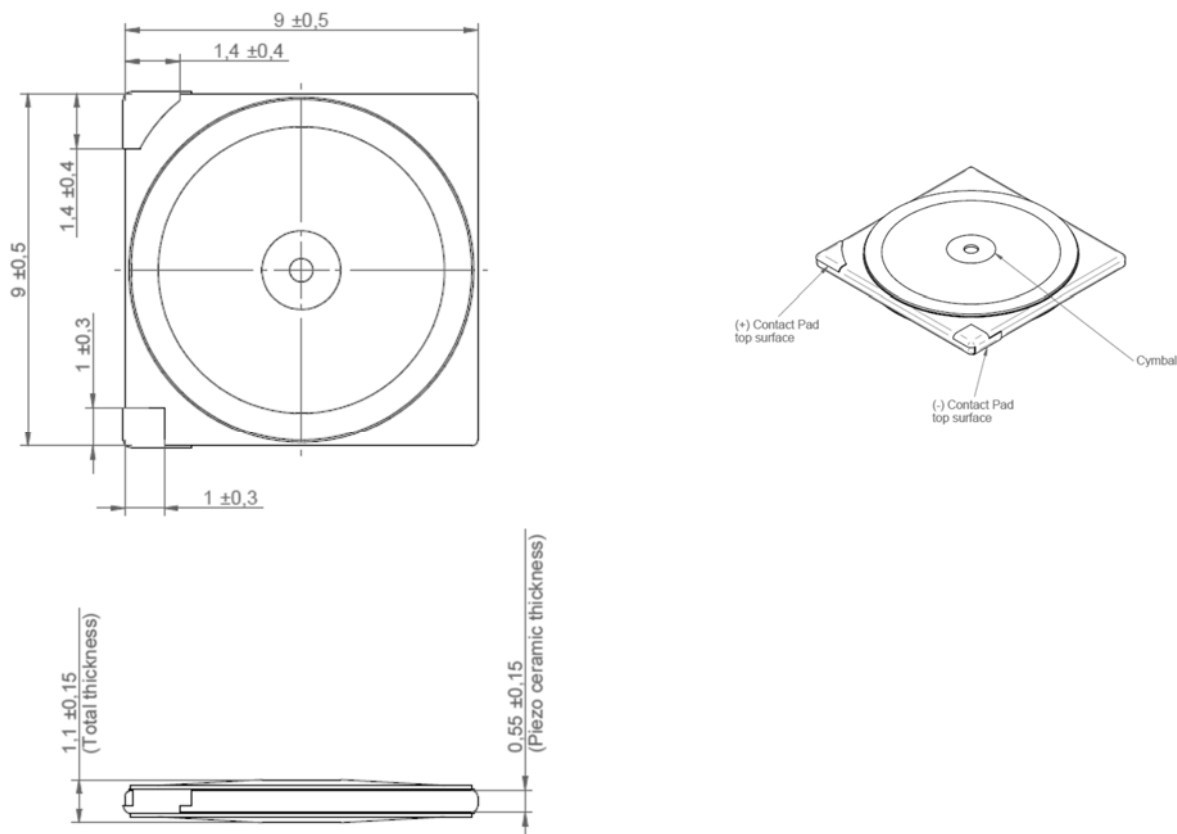

Fig. 1: Dimensional drawings

General

Polarity of the prototypes: “+” is the larger metallization area

Typical characteristics of PowerHap 0909H011V060 as a design reference for haptic applications

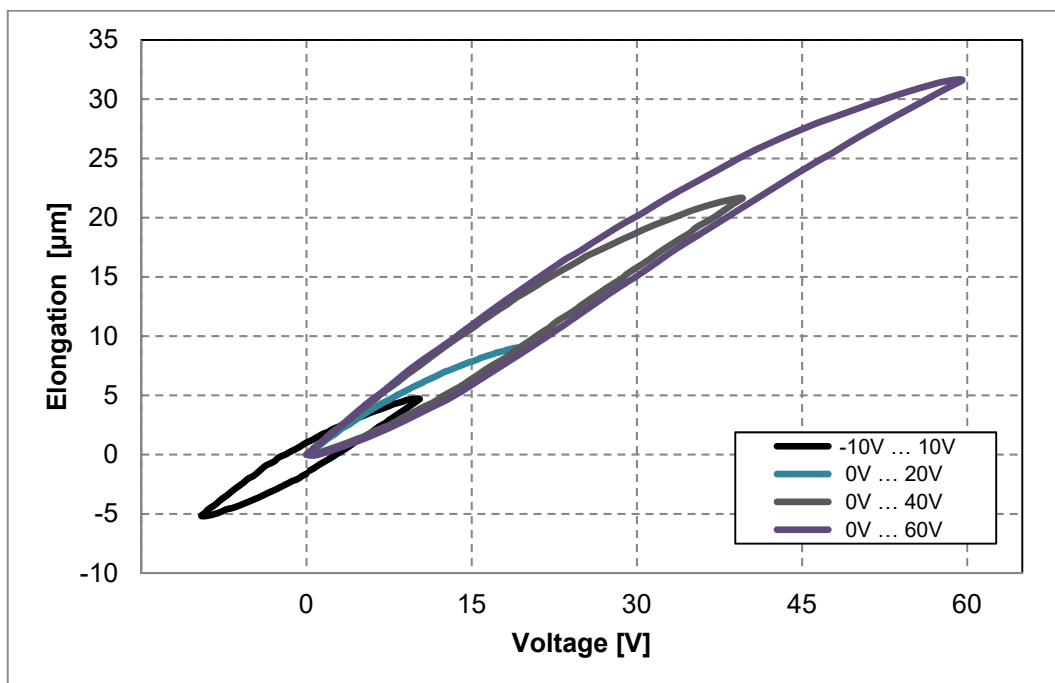

Fig. 2: Elongation measured between cymbal end-caps as a function of voltage.

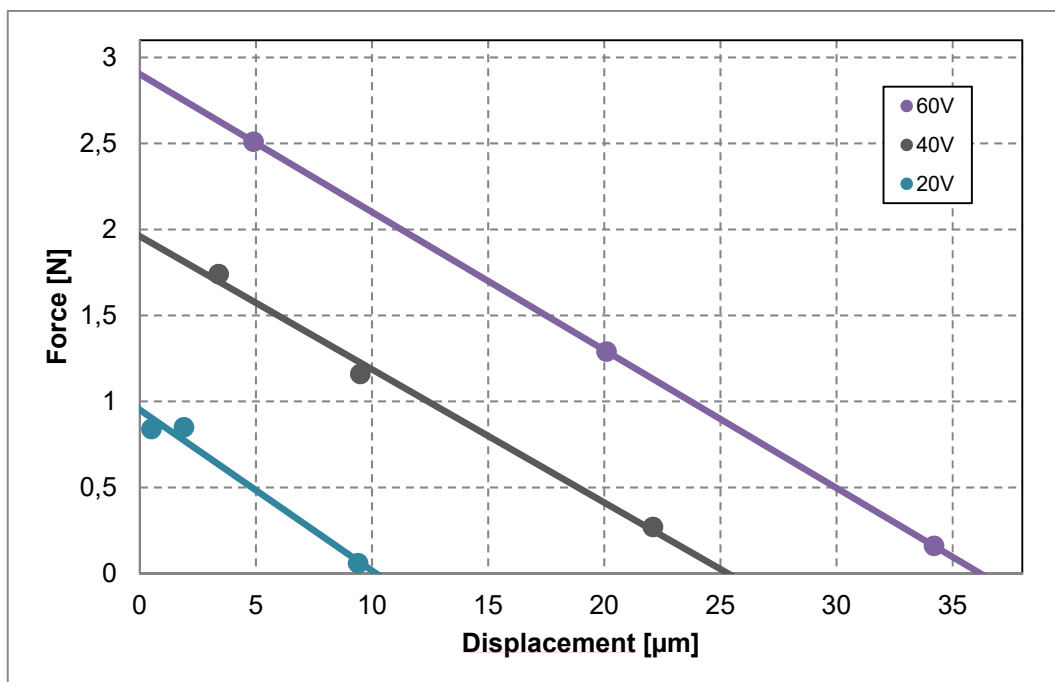

Fig. 3: Force-stroke diagram with different load springs. Typical stiffness 80 N/mm.

Acceleration measurement on test set up

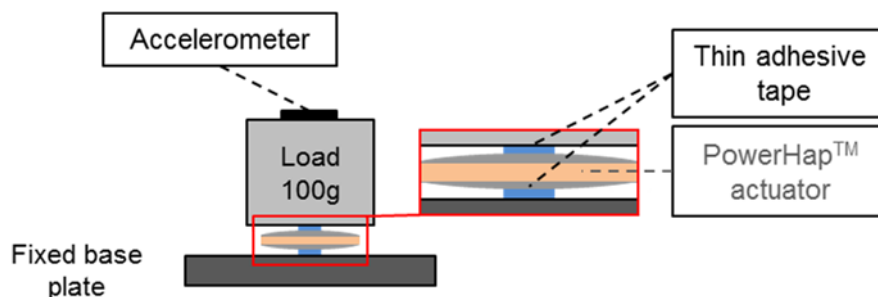

Fig. 4: Measurement setup for acceleration.

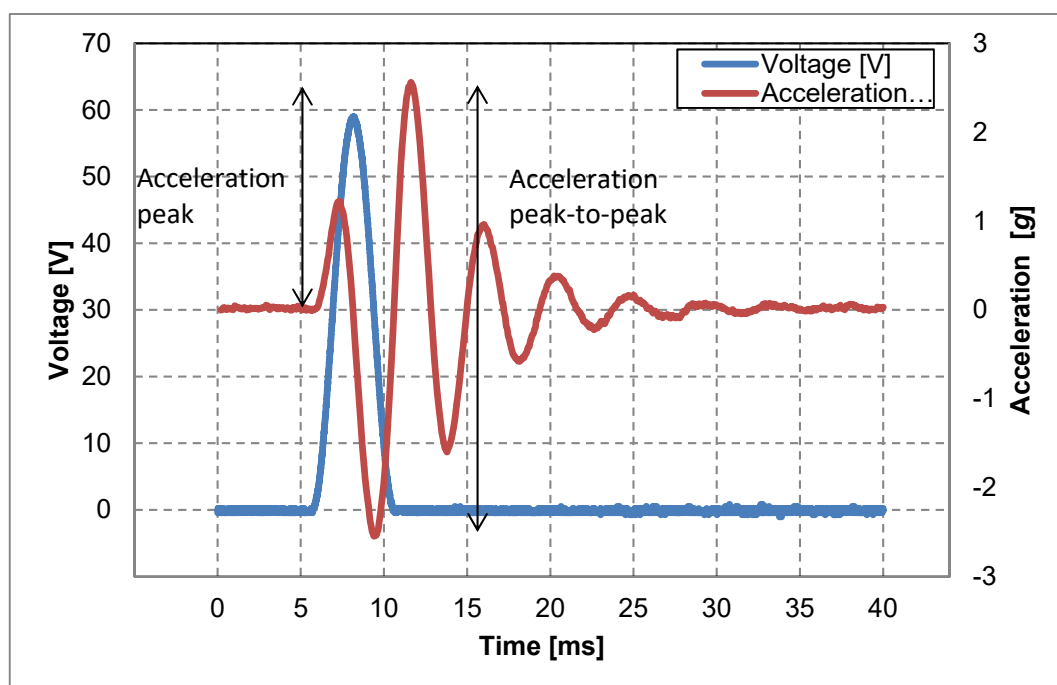

Fig. 5: Typical acceleration g as a function of input voltage with 100 g load. Input voltage with a half wave sinus signal form of amplitude 0 ... 60 V and pulse length 5 ms which is equivalent to 200 Hz.

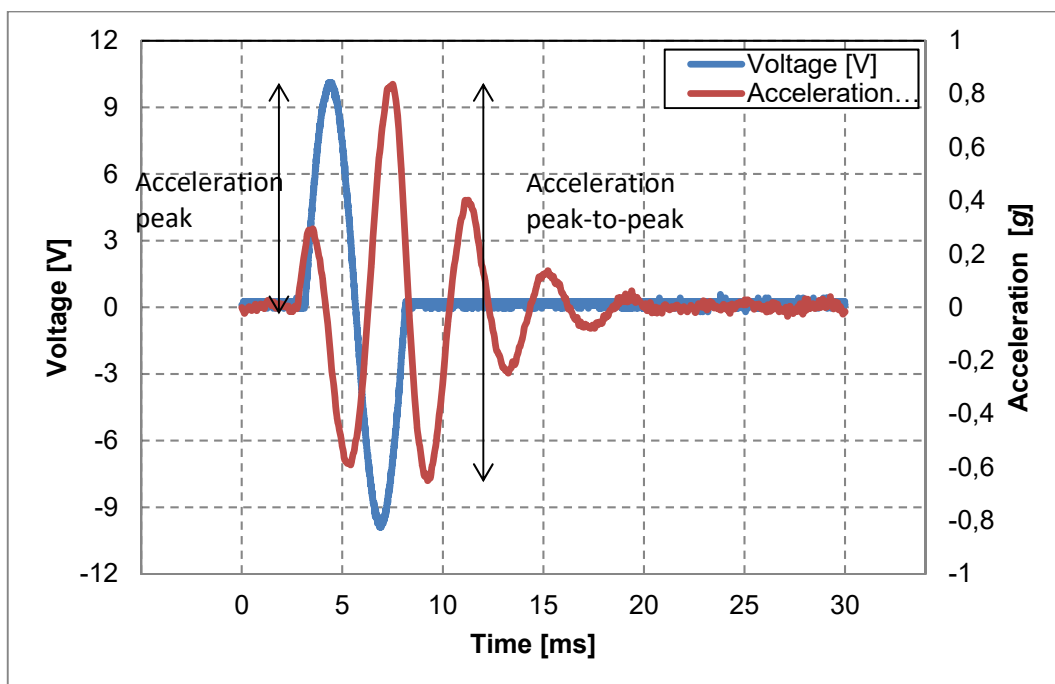

Fig. 6: Typical acceleration g as a function of input voltage with 100 g load. Input voltage with a sinus signal form of amplitude -10 ... 10 V and pulse length 5 ms which is equivalent to 200 Hz.

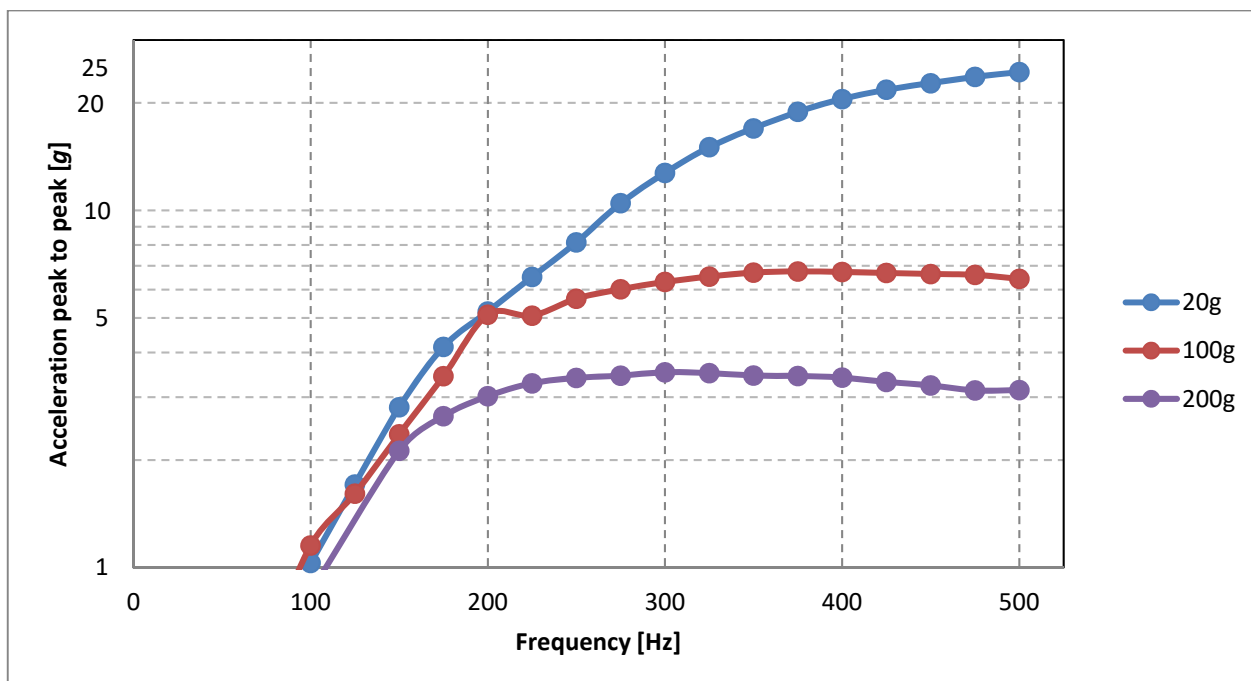

Fig. 7: Acceleration g as a function of frequency for different loads. Input voltage has a single pulse half wave sinus signal form of amplitude 0 ... 60 V and varying frequency from 50 ... 500 Hz.

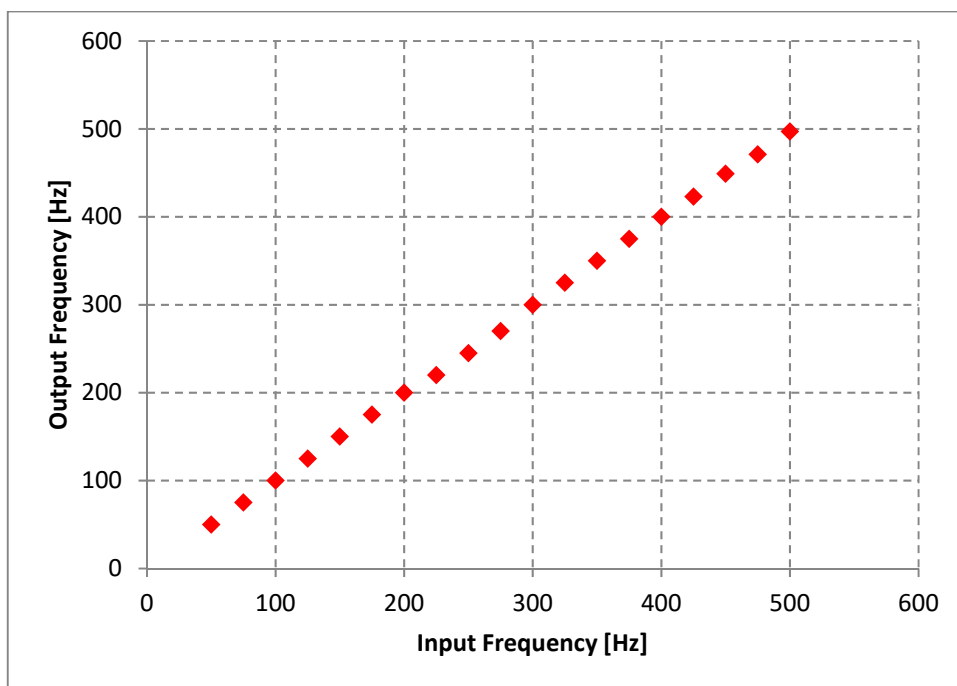

Fig. 8: Output frequency of acceleration vs. input voltage signal frequency for 10 pulses. Input voltage has a single pulse half wave sinus signal form of amplitude 0 ... 60 V and varying frequency from 50 ... 500 Hz. The frequency of output acceleration is calculated.

Typical sensor characteristics

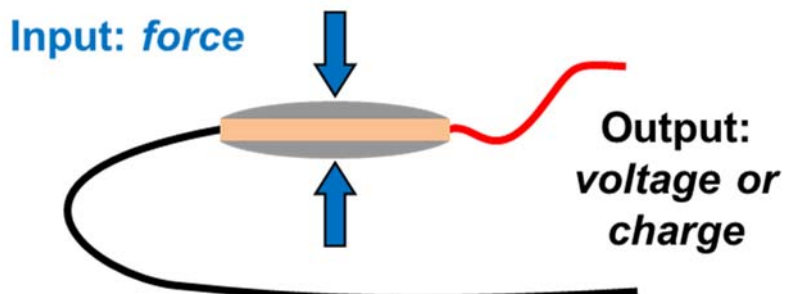

Fig. 9: Measurement setup for measurement of sensor signal.

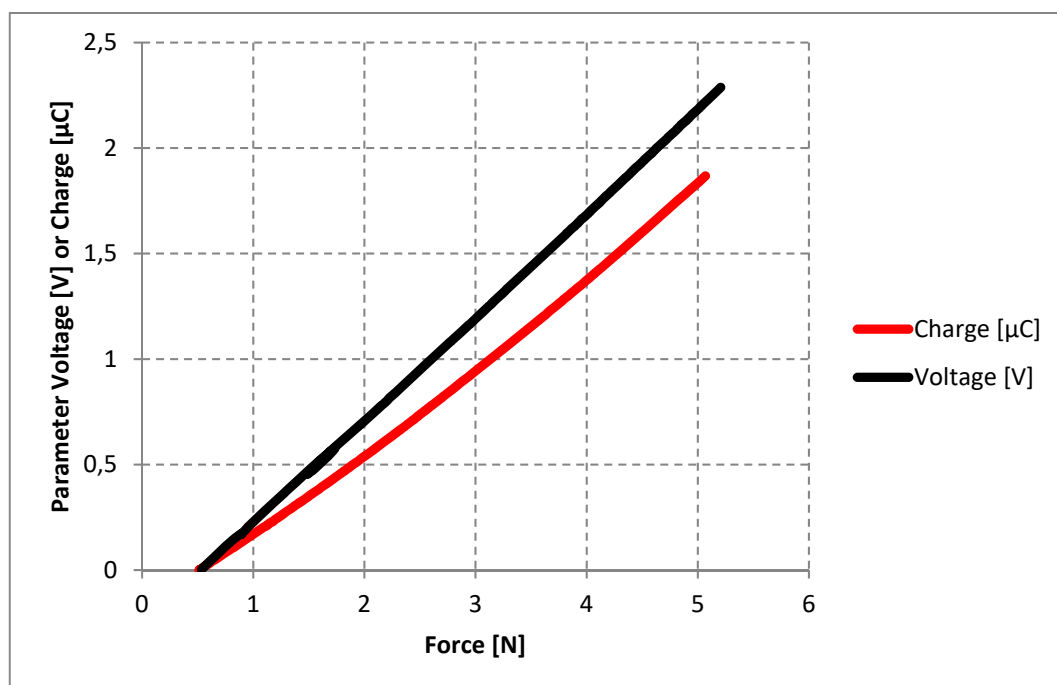

Fig. 10: Sensor characteristics open circuit voltage or short circuit charge as a function of force input.

Recommended reflow soldering profile

Fig. 11: Reflow soldering profile.

Profile feature		SAC, Sn95.5Ag3.8Cu0.7 @ N ₂ atmosphere
Preheat and soak		
- Temperature min	T_{smin}	+150 °C
- Temperature max	T_{smax}	+200 °C
- Time	t_{smin} to t_{smax}	70 ... 120 seconds
Average ramp-up rate	T_L to T_p	+3 °C/ second max.
Liquidus temperature	T_L	+217 °C
Time at liquidus temperature	t_L	60 ... 100 seconds
Peak package body temperature	$T_p^{(1)}$	+235 ... +260 °C max. ²⁾
Time (t_p) ³⁾ within 5 °C of specified classification temperature (T_c)		10 ... 40 seconds
Average ramp-down rate	T_p to T_L	+6 °C/ second max.
Time 25 °C to peak temperature		maximum 8 minutes

Important notes for reflow soldering:

- All temperatures refer to topside of the part, measured on the part body surface.
- Max. number of reflow cycles: 3.
- The components are suitable for reflow soldering to IEC 60068-2-58.
- After the soldering process, the capacitance, total elongation is increased. Total allowed change is $\pm 30\%$.
- Contacts of PowerHap™ must be shorted during the reflow process so as not to generate stresses on the adhesive during the temperature change.
- It must be ensured that the height of the contact board or wire is lower than the height of the cymbal top surface (<0.2 mm).
- No mechanical or electrical excitation should be performed on the part for at least 3 hours after reflow process.
- The contacting element (flexible PCB or wires) must be flexible. If the contacting element is too stiff it may cause cracks in the ceramic which can lead to short circuit and eventually failure of the part. For example a stiffener must not be used in the design of the flexible PCB.

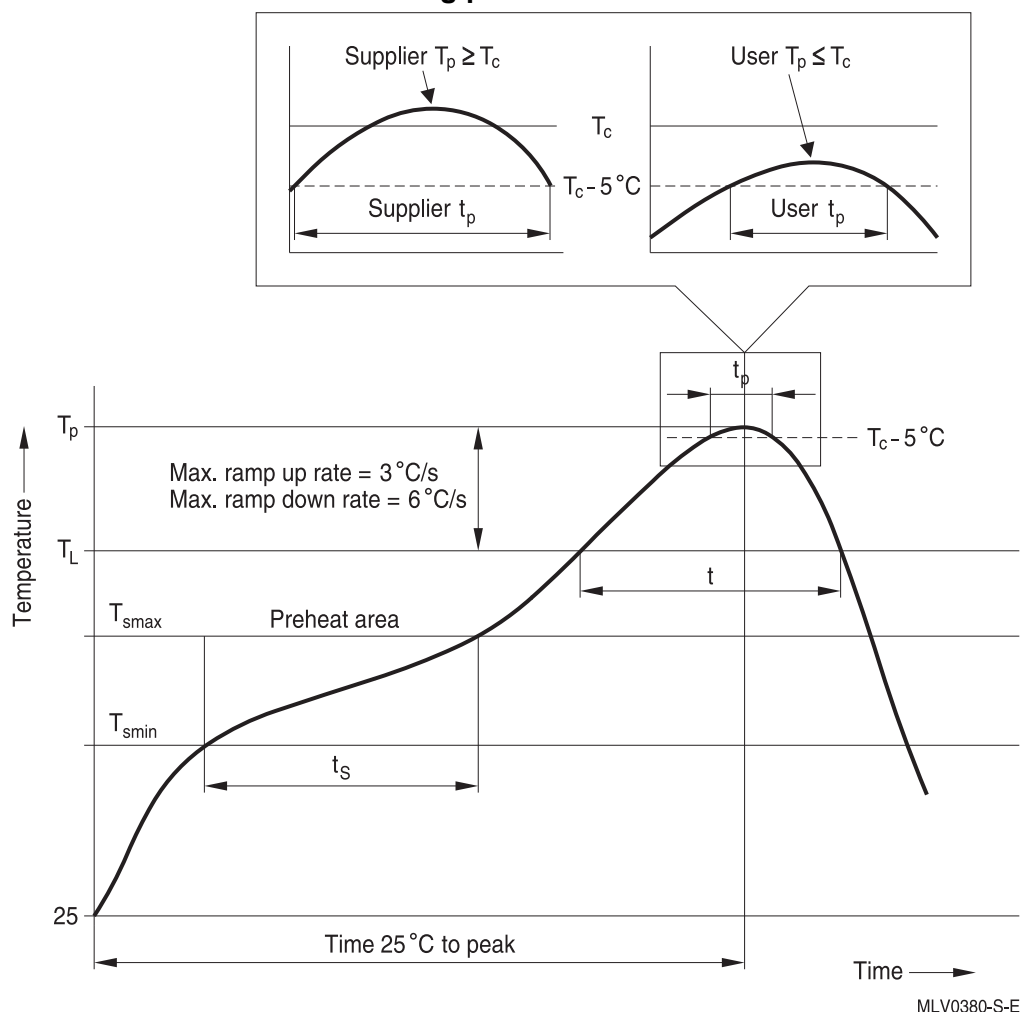
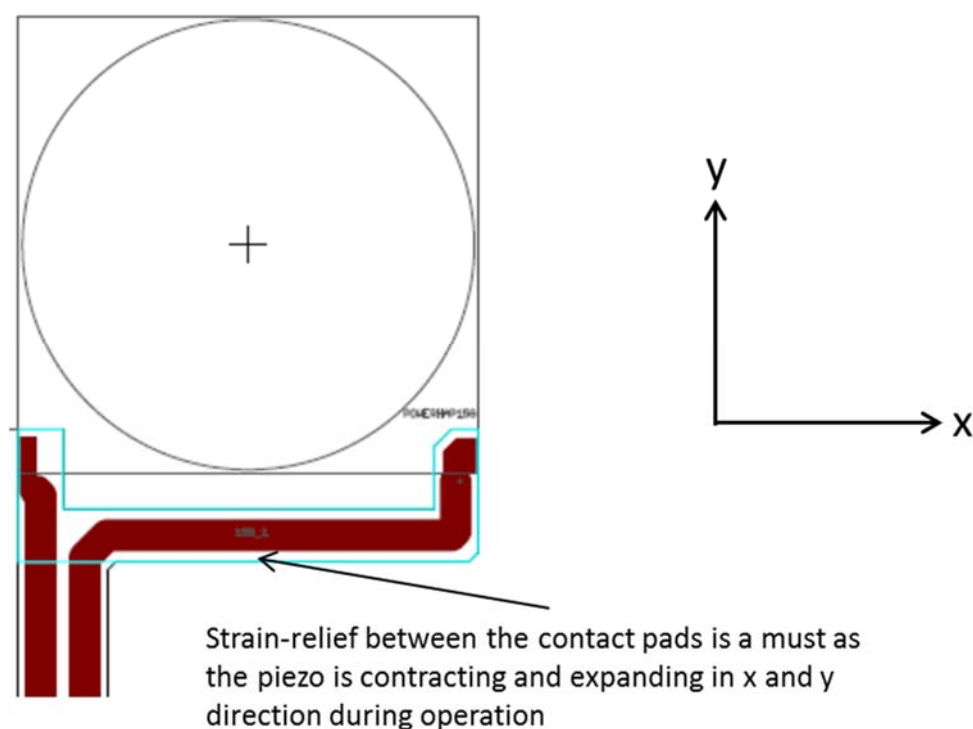

Fig. 12: Example of PowerHap with flexible PCB contact element.

Application note

PowerHap components can be used as both, as actuators or sensors. Depending on area of application and geometry PowerHap actuators can be mounted and operated in various ways. Some options shall be explained in more detail.

Mounting underneath a surface

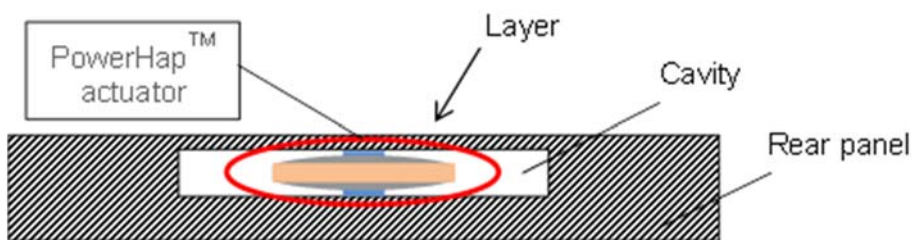

Fig. 13: Schematic Illustration using the PowerHap actuator underneath a thin and flexible layer, e.g. implementation underneath buttons.

The PowerHap actuator is mounted between a thin and flexible (“membrane-like”) layer and a rigid rear panel. Applying a voltage to the actuator will result in elongation of the latter inducing a deformation of the layer and in consequence in the generation of a so-called haptic feedback.

In principle the material for the covering layer (glass, plastic, thin metal, rubber) does not matter, but it might be important to tune the thickness to ensure flexibility. To maximize the haptic feedback the layer needs to be as flexible as possible, nonetheless some stiffness is required to have a proper clamping of the actuator. Preload stiffness should be around <50% of the stiffness of the actuator.

Quite the opposite requirements are needed for the rear panel; it needs to be as stiff as possible, so that only the cover layer is deformed by the actuator. An optimal performance is reached when the preload on the actuator is in the range of 2 - 4 N.

Direct mounting to a load

The PowerHap actuator is suitable for many different applications. If necessary the PowerHap actuator can be mounted directly underneath the load (e.g. touchscreen display, glass digitizer etc.). In such cases the load is not flexible as in the previous example, therefore a free movement in the desired direction of the load is mandatory, this can be accomplished in the simplest case through the usage of some elastic element (e.g. coil springs for z-direction in Fig. 14) or with more sophisticated elastic buffer solutions (fig. 16).

By applying a voltage to the actuator, the resulting elongation is used to move the load. The movement (acceleration) of the load can be felt by the user as haptic feedback. For a maximum feedback, the rear panel needs to be as heavy and rigid as possible, otherwise performance will be lost due to the movement of both, load and rear panel.

In the simplest case the weight of the load applies the required tension to the actuator and consequently fixates the actuator at the desired position. Additional fixation of the position of the actuator can be done by fixation of it to the rear panel, the load or both (by e.g. adhesive tape, glue etc.). In case of fixing it to both, the possible tensile stress on the actuator while in operation has to be taken into consideration for the application.

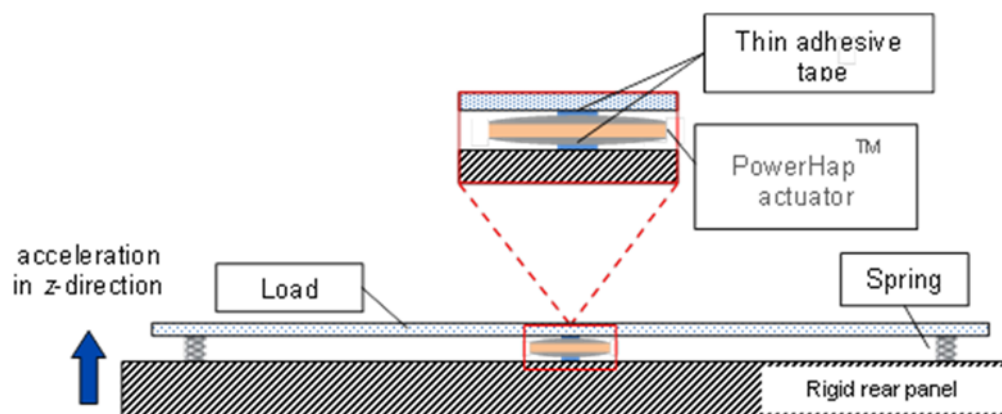

Fig. 14: Schematic drawing of a simplified setup involving the usage of springs to ensure the movement of a non-flexible load in z-direction.

Usage of multiple actuators

PowerHap actuators are optimized to deliver a strong sensible haptic feedback. One actuator might be sufficient if lightweight loads are moved (e.g. 0.1 kg with 2626H023V120). Acceleration values decrease with increasing weight, meaning that the acceleration of heavy loads might result in a weak or even unnoticeable haptic feedback (e.g. wide displays, huge screens etc.). If this is the case, there is the possibility to combine multiple actuators.

Application Option A

Acceleration of a complete touchscreen display

A touchscreen display can be easily moved by the implementation of PowerHap actuators (depending on the screen area more than one actuator will be needed to apply a uniform haptic feedback throughout the whole display). The schematic drawing shows a possible setup involving four actuators to generate haptic feedback onto the surface of a relatively heavy display (e.g. automotive application).

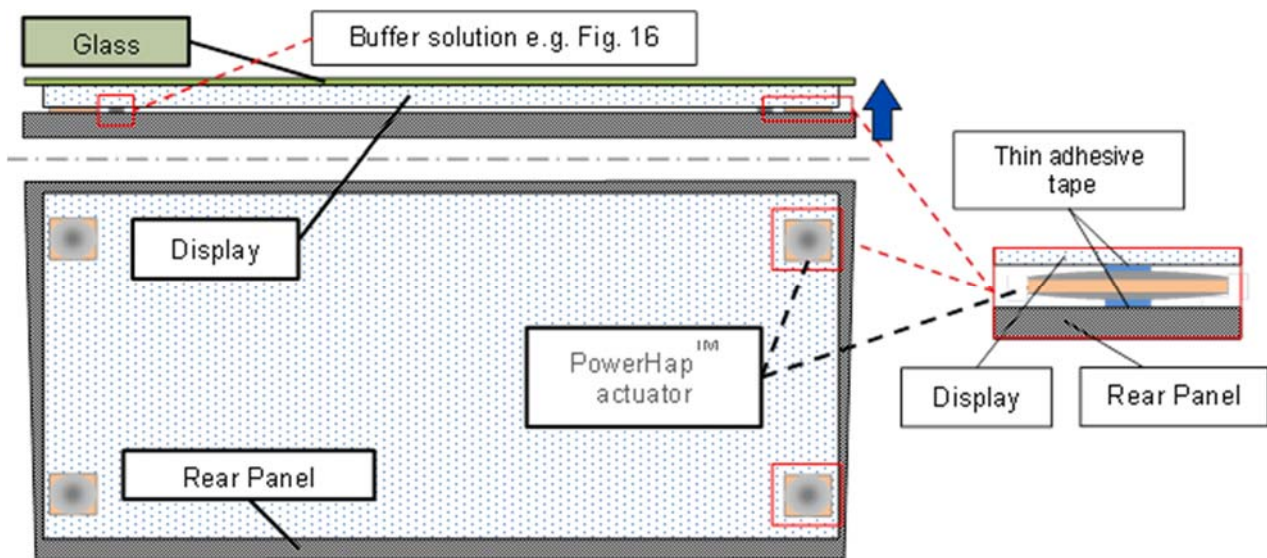

Fig. 15: Schematic drawing of a possible user application of the PowerHap actuator for generating a haptic feedback onto a touchscreen panel display.

In the simplest case the movement in z-direction can be ensured by the usage of coil springs or a rubber (this case requires no direct fixation of the display to the rear panel), more sophisticated would be the implementation of a buffer system located at the fixation point of the display to the rear panel. Depending on geometry, design and material of the buffer, a free movement of the display can be guaranteed independent of the direction. A possible elementary buffer setup can be found in figure 16.

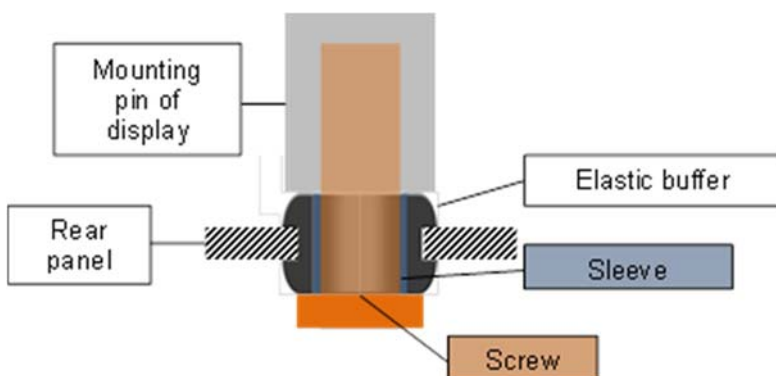

Fig. 16: Schematic drawing of a potential option for a buffer that is able to ensure movement x,y- and z-direction depending on the material and the dimension of the elastic buffer used.

Application Option B

Acceleration of a display digitizer only

For some application a free movement of the whole display cannot be implemented due to the architecture of the display. Here, another option would be the acceleration of the digitizer alone (if the display architecture allows it).

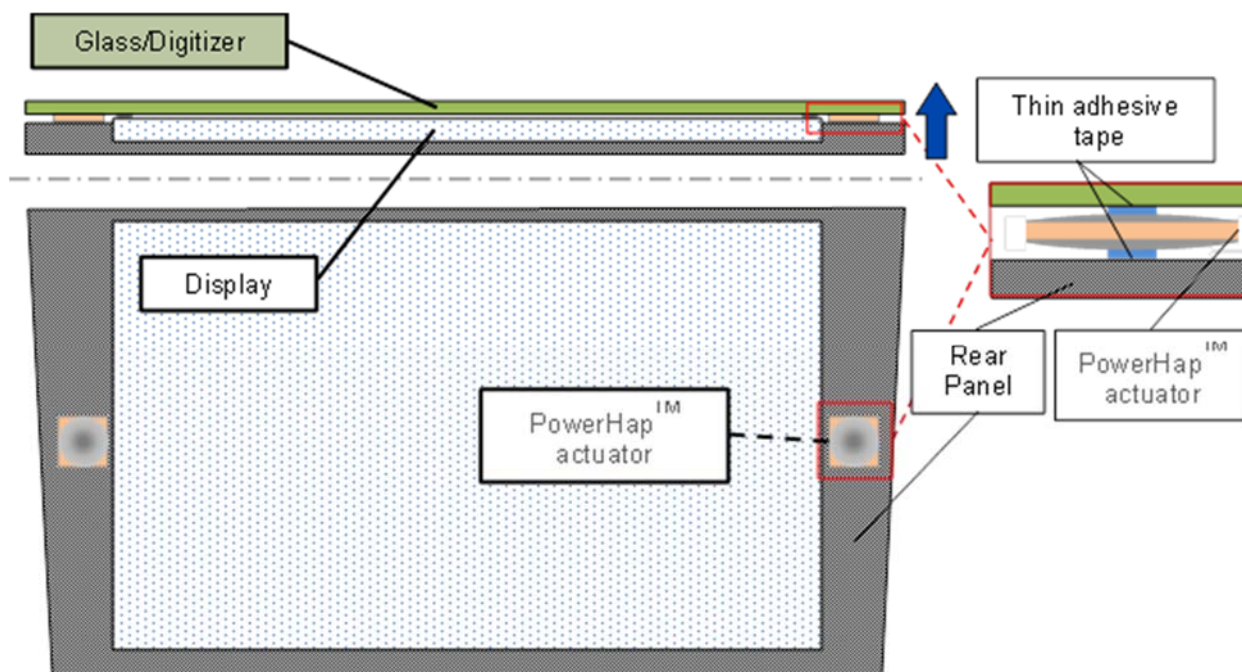

Fig. 17: Schematic drawing of a possible user application of the PowerHap actuator for generating a haptic feedback onto the digitizer of a display.

In the schematic drawing of figure 17 two PowerHap actuators are used to move the digitizer only. In most cases the weight of the digitizer is less compared to the whole display panel, therefore usually two actuators might be sufficient to generate a convenient haptic feedback for the user.

Packaging

Cardboard box	Packaging unit 88 pcs.
---------------	------------------------

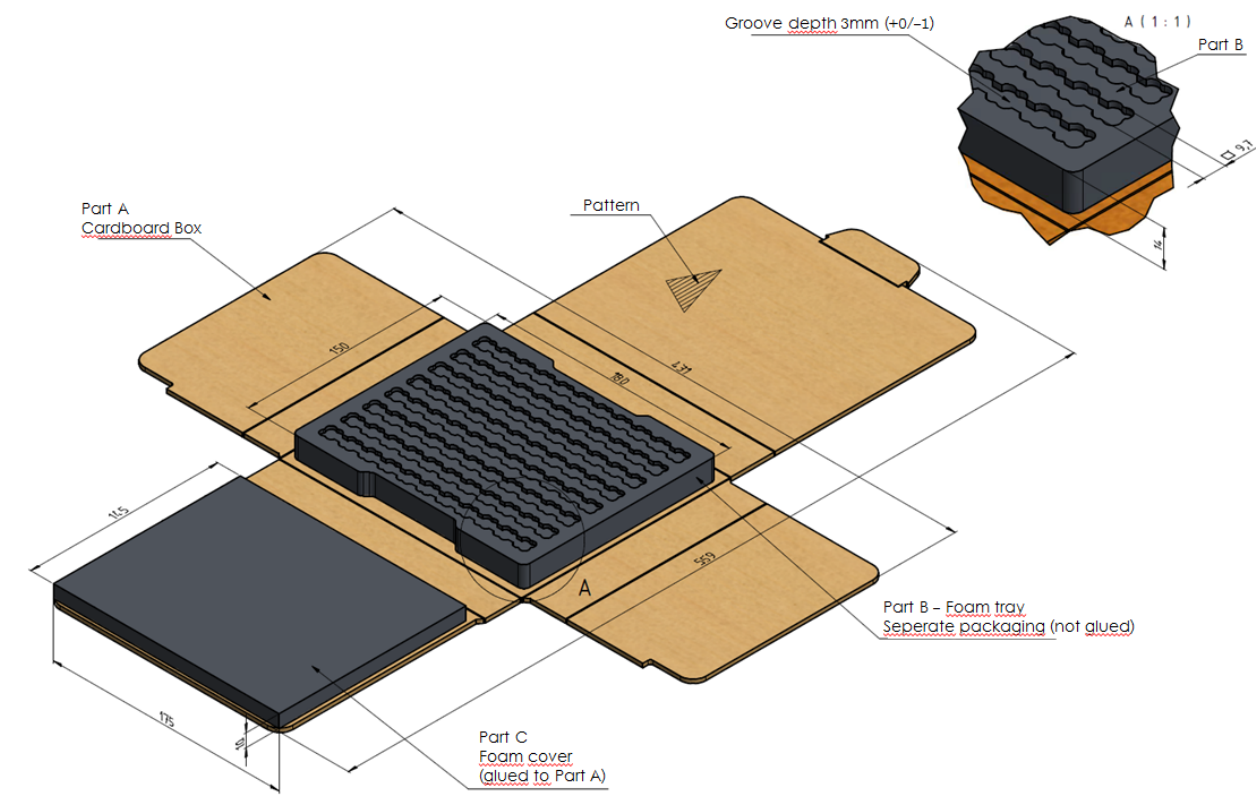

Fig. 18: Drawing of the packaging unit.

General Notes

Some parts of this publication contain statements about the suitability of our ceramic piezo components for certain areas of application, including recommendations about incorporation/design-in of these products into customer applications. The statements are based on our knowledge of typical requirements made of our devices in the particular areas. We nevertheless expressly point out that such statements cannot be regarded as binding statements about the suitability of our piezo components for a particular customer application. As a rule, TDK is either unfamiliar with individual customer applications or less familiar with them than the customers themselves. For these reasons, it is always incumbent on the customer to check and decide whether the piezo component devices with the properties described in the product specification are suitable for use in a particular customer application.

- Do not use piezo components for purposes not identified in our specifications, application notes and data sheets.
- Ensure the suitability of a piezo component in particular by testing it for reliability during design-in. Always evaluate a Piezo component under worst-case conditions.
- Pay special attention to the reliability of piezo devices intended for use in safety-critical applications (e.g. medical equipment, automotive, spacecraft, nuclear power plant).
- Do not drive the piezo actuator under resonance conditions.

Design notes

- Consider de-rating at higher operating temperatures and loads.
- In some cases the malfunctioning of passive electronic components or failure before the end of their service life cannot be completely ruled out in the current state of the art, even if they are operated as specified. In applications requiring a very high level of operational safety and especially when the malfunction or failure of a passive electronic component could endanger human life or health (e.g. in accident prevention, life-saving systems, or automotive battery line applications such as clamp 30), ensure by suitable design of the application or other measures (e.g. installation of protective circuitry or redundancy) that no injury or damage is sustained by third parties in the event of such a malfunction or failure. Do not use piezo components in safety-relevant applications.
- Specified values only apply to piezo components that have not been subject to prior electrical, mechanical or thermal damage.

Operation

- Use piezo actuator components only within the specified operating temperature range.
- Use piezo actuator components only within specified voltage and current ranges.
- Piezo actuator components have to be operated in a dry, non-reducing atmosphere which must not contain any additional chemical vapours or substances. We recommend appropriate drying of all components prior to hermetically sealing.
- We recommend a preload of at least 1 N.
- Prevent a piezo actuator component from contacting liquids and solvents. Make sure that no water enters a piezo actuator component (e.g. through plug terminals).
- Avoid dewing and condensation.

- Our piezo actuator components are mainly designed for encased applications. Under all circumstances avoid exposure to:
 - direct sunlight
 - rain or condensation
 - steam, saline spray
 - corrosive gases
 - atmosphere with reduced oxygen content.
- We expressly point out that in case of non-observance of the aforesaid notes, in particular due to reasons attributable to chemical vapours, a malfunction or failure of the piezo actuator components before the end of their usual service life cannot be completely ruled out, even if they are operated as specified.

Storage, handling and mounting instructions

Storage

- Store the piezo actuator component with terminals short-circuited.
- Avoid contamination of the piezo actuator component surface during storage.
- Avoid storage of the piezo actuator components in harmful environments where they are exposed to corrosive gases (e.g. SO_x, Cl).
- Storage conditions:
 Storage temperature: -25 to +45 °C
 Relative humidity (RH): ≤ 75% annual average, ≤ 95% on 30 days a year.
 Dew precipitation is inadmissible.
- Process piezo actuator components within 12 months after shipment from TDK Electronics.

Handling

- Do not drop piezo actuator components or allow them to be chipped.
- Apply maximum force of 4 N at the component during handling.
- Do not touch piezo actuator component with bare hands, powderless nitrile gloves are recommended.
- Avoid contamination of the piezo actuator component surface during handling.

Mounting

- Make sure the surface of the leads is not scratched before, during or after the mounting process.
- Make sure contacts and housings used for assembly with piezo actuator components are clean and dry before mounting.
- Avoid contamination of the surface of the piezo actuator component during processing.
- Make sure ceramic end surfaces are clean before mounting process. We recommend to short-circuit the piezo actuator component during the whole mounting process.

Cautions and warnings

The piezo component has to be operated in a dry, non-reducing, open environment and atmosphere which must not contain any chemical vapors or substances.

To prevent damages on the piezo component, tensile stresses must be avoided under all driving conditions.

We expressly point out that in case of non-observance of the aforesaid notes, in particular due to reasons attributable to chemical vapors, a malfunction of the piezo sample or failure before the end of their usual service life cannot be completely ruled out, even if they are operated as specified.

Depending on the individual application, piezo samples are electrically connected to voltages and currents, which are potentially dangerous for life and health of the operator. Installation and operation of piezo sample have to be done only by authorized personnel. Ensure proper and safe connections, couplers, and drivers.

Caution: Piezo component are highly efficient charge storing capacitors. Even when they are disconnected from a supply, the electrical energy content of a loaded actuator can be high and is held for a long time. Always ensure a complete discharging of an actuator (e.g. via a 10 k Ω resistor) before handling. (Do not discharge by simple short-circuiting, because of the risk of damaging the ceramic.)

Electrical charges can be generated on disconnected actuators by varying load or temperature.

Caution: Discharge an actuator before connecting it to a measuring device/electronics, when this device is not sufficiently voltage proofed.

Remark

The products delivered are engineering samples, prototypes or pre-series products, which are not intended for commercial use in series products of the purchaser. We assume no warranty for these products. Any use is at the sole risk of the purchaser.

Contains SVHC Substance 12626-81-2

Display of ordering codes for TDK Electronics products

The ordering code for one and the same product can be represented differently in data sheets, data books, other publications, on the company website, or in order-related documents such as shipping notes, order confirmations and product labels. **The varying representations of the ordering codes are due to different processes employed and do not affect the specifications of the respective products.** Detailed information can be found on the Internet under www.tdk-electronics.tdk.com/orderingcodes.

Important notes

The following applies to all products named in this publication:

1. Some parts of this publication contain **statements about the suitability of our products for certain areas of application**. These statements are based on our knowledge of typical requirements that are often placed on our products in the areas of application concerned. We nevertheless expressly point out **that such statements cannot be regarded as binding statements about the suitability of our products for a particular customer application**. As a rule we are either unfamiliar with individual customer applications or less familiar with them than the customers themselves. For these reasons, it is always ultimately incumbent on the customer to check and decide whether a product with the properties described in the product specification is suitable for use in a particular customer application.
2. We also point out that **in individual cases, a malfunction of electronic components or failure before the end of their usual service life cannot be completely ruled out in the current state of the art, even if they are operated as specified**. In customer applications requiring a very high level of operational safety and especially in customer applications in which the malfunction or failure of an electronic component could endanger human life or health (e.g. in accident prevention or life-saving systems), it must therefore be ensured by means of suitable design of the customer application or other action taken by the customer (e.g. installation of protective circuitry or redundancy) that no injury or damage is sustained by third parties in the event of malfunction or failure of an electronic component.
3. **The warnings, cautions and product-specific notes must be observed.**
4. In order to satisfy certain technical requirements, **some of the products described in this publication may contain substances subject to restrictions in certain jurisdictions (e.g. because they are classed as hazardous)**. Useful information on this will be found in our Material Data Sheets on the Internet (www.tdk-electronics.tdk.com/material). Should you have any more detailed questions, please contact our sales offices.
5. We constantly strive to improve our products. Consequently, **the products described in this publication may change from time to time**. The same is true of the corresponding product specifications. Please check therefore to what extent product descriptions and specifications contained in this publication are still applicable before or when you place an order.

We also **reserve the right to discontinue production and delivery of products**. Consequently, we cannot guarantee that all products named in this publication will always be available. The aforementioned does not apply in the case of individual agreements deviating from the foregoing for customer-specific products.

6. Unless otherwise agreed in individual contracts, **all orders are subject to our General Terms and Conditions of Supply**.
7. **Our manufacturing sites serving the automotive business apply the IATF 16949 standard**. The IATF certifications confirm our compliance with requirements regarding the quality management system in the automotive industry. Referring to customer requirements and customer specific requirements ("CSR") TDK always has and will continue to have the policy of respecting individual agreements. Even if IATF 16949 may appear to support the acceptance of unilateral requirements, we hereby like to emphasize that **only requirements mutually agreed upon can and will be implemented in our Quality Management System**. For clarification purposes we like to point out that obligations from IATF 16949 shall only become legally binding if individually agreed upon.

Important notes

8. The trade names EPCOS, CeraCharge, CeraDiode, CeraLink, CeraPad, CeraPlas, CSMP, CTVS, DeltaCap, DigiSiMic, ExoCore, FilterCap, FormFit, LeaXield, MiniBlue, MiniCell, MKD, MKK, MotorCap, PCC, PhaseCap, PhaseCube, PhaseMod, PhiCap, PowerHap, PQSine, PQvar, SIFERRIT, SIFI, SIKOREL, SilverCap, SIMDAD, SiMic, SIMID, SineFormer, SIOV, ThermoFuse, WindCap are **trademarks registered or pending** in Europe and in other countries. Further information will be found on the Internet at www.tdk-electronics.tdk.com/trademarks.

Release 2018-10

X-ON Electronics

Largest Supplier of Electrical and Electronic Components

Click to view similar products for [Tactile Switches](#) category:

Click to view products by [EPCOS](#) manufacturer:

Other Similar products are found below :

[KMR633NG LFG](#) [5GTH9202242](#) [6426-201-11343](#) [MJ1226](#) [MJTP1109B](#) [MJTP1138EAUTR](#) [MJTP1230BL](#) [MJTPSHW](#) [GS6.90F300QP](#) [1-1977223-0](#) [1-1977120-4](#) [ADTSA62NV](#) [ADTSA62RV](#) [ADTSA63KV](#) [ADTSA644NV](#) [ADTSM24NVTR](#) [ADTSMW66NV](#) [ADTSMW67RV](#) [ATM533VTR](#) [1571300-3](#) [B3F-3123](#) [B3F-6055A](#) [B3F-B32-01-KIT](#) [1977177-8](#) [1977266-1](#) [2-1977223-4](#) [2-1977223-7](#) [ADTS644KV](#) [ADTSA61RV](#) [ADTSA62KV](#) [ADTSA63NV](#) [ADTSA63RV](#) [ADTSA65NV](#) [ADTSM21NSVTR](#) [ADTSM25RVTR](#) [ADTSM31RVTR](#) [ADTSM32NVTR](#) [ADTSM61YVTR](#) [ADTSM63SVTR](#) [ADTSM644KVTR](#) [ADTSMW64RV](#) [ADTSMW69NV](#) [FSMRA4JHA04](#) [GS4.70F300QP](#) [D38999/20JJ37SA](#) [TL1105B](#) [TL1105J](#) [ATH447K2Q](#) [ATM534VTR](#) [MJ1215](#)