



Capacitors with Screw Terminals

B43564

Long Useful Life – 85 °C

B43584

Long-life grade capacitors

Applications

- Frequency converters
- Uninterruptible power supplies
- For switch-mode power supplies in professional equipments

Features

- High reliability
- Extremely good electrical characteristics and small dimensions
- High ripple current capability
- All-welded construction ensures reliable electrical contact
- Version with optimized construction for base cooling (2-pad solution) available
- Version with low-inductance design available
- Self-extinguishing electrolyte

Construction

- Charge-discharge proof, polar
- Aluminum case with insulating sleeve
- Poles with screw terminal connections
- Mounting with ring clips, clamps or threaded stud
- The bases of types with threaded stud and $d \leq 76,9$ mm are not insulated, types with $d = 91$ mm have fully insulated bases

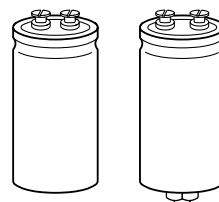

B43564

KAL0567-B

B43584

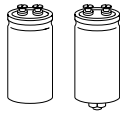

B43564 / B43584

Long Useful Life – 85 °C

Specifications and characteristics in brief

Rated voltage U_R	350 ... 500 VDC	
Surge voltage U_S	1,15 · U_R (for $U_R \leq 250$ VDC) 1,10 · U_R (for $U_R \geq 350$ VDC)	
Rated capacitance C_R	820 ... 10 000 μ F	
Capacitance tolerance	± 20 % \triangleq M	
Leakage current I_L (5 min, 20 °C)	$I_L \leq 0,3 \mu\text{A} \cdot \left(\frac{C_R}{\mu\text{F}} \cdot \frac{U_R}{\text{V}}\right)^{0,7} + 4 \mu\text{A}$	
Self-inductance ESL	Approx. 20 nH Capacitors with low-inductance design: $d \geq 64,3$ mm: approx. 13 nH	
Useful life	350...450 V	500 V
	85 °C; U_R ; $I_{\sim R}$ 40 °C; U_R ; 1,5 · $I_{\sim R}$ 40 °C; U_R ; 1,4 · $I_{\sim R}$	> 15 000 h > 12 000 h > 250 000 h – > 250 000 h
		Requirements: $\Delta C/C \leq \pm 30$ % of initial value $ESR \leq 3$ times initial specified limit $I_L \leq$ initial specified limit Failure percentage: ≤ 1 % Failure rate: ≤ 40 fit ($\leq 40 \cdot 10^{-9}/\text{h}$) (for definition "fit", refer to chapter "Quality", page 62)
Voltage endurance test 85 °C; U_R	2 000 h	
	Post test requirements: $\Delta C/C \leq \pm 10$ % of initial value $ESR \leq 1,3$ times initial specified limit $I_L \leq$ initial specified limit	
Vibration resistance	To IEC 60068-2-6, test Fc: displacement amplitude 0,75 mm, frequency range 10 to 55 Hz, acceleration max. 10 g, duration 3 × 2 h	
IEC climatic category	To IEC 60068-1: 25/085/56 (– 25 °C/+ 85 °C/56 days damp heat test)	
Detail specifications	Similar to CECC 30301-803, CECC 30301-807	
Sectional specification	IEC 60384-4	

Ripple current capability

Due to the ripple current capability of the contact elements, the following current upper limits must not be exceeded:

Capacitor diameter	51,6 mm	64,3 mm	76,9 mm	91,0 mm
$I_{\sim \text{max}}$	30 A	40 A	50 A	70 A



B43564 / B43584

Long Useful Life – 85 °C

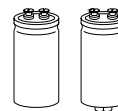

Dimensional drawings

Type B43564
Ring clip/clamp mounting

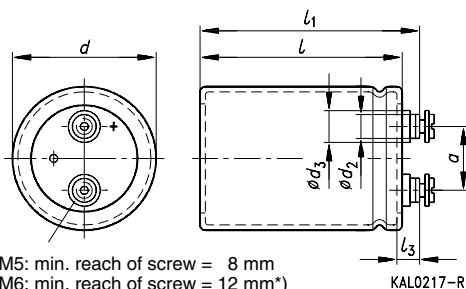

M5: min. reach of screw = 8 mm
M6: min. reach of screw = 12 mm*)
*) 8 mm for low-inductance design

KAL0217-R

Type B43584
Threaded stud mounting

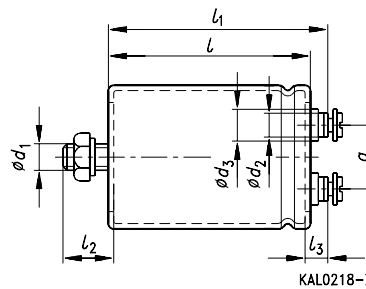

KAL0218-Z

Positive pole marking: +

The base of types with stud mounting and $d = 91$ mm is fully insulated (the lengths l and l_1 are increased by 0,5 mm in these cases). For types with stud mounting and $d \leq 76$ mm the base is not insulated. Also refer to the notes on mounting given on page 168.

Dimensions and weights

Terminal	Dimensions (mm) with insulating sleeve									Approx. wt. (g)
	d	$l \pm 1$	$l_1 \pm 1$	$l_2^{+0}_{-1}$	l_3	d_1	$d_2 \text{ max}$	$d_3 \text{ max}$	$a^{+0,2}_{-0,4}$	
M 5	51,6 +0/-0,8	80,7	87,2	17	7,0 +0,2/-1	M 12	8,2	13,5	22,2	220
M 5	51,6 +0/-0,8	105,7	112,2	17	7,0 +0,2/-1	M 12	8,2	13,5	22,2	280
M 5	64,3 +0/-0,8	105,7	112,2	17	7,0 +0,2/-1	M 12	8,2	13,5	28,5	440
M 6	76,9 +0/-0,7	105,7	111,5	17	6,4 +1,1/-0,8	M 12	17,7	17,7	31,7	540
M 6	76,9 +0/-0,7	143,2	149,0	17	6,4 +1,1/-0,8	M 12	17,7	17,7	31,7	840
M 6	76,9 +0/-0,7	220,7	226,5	17	6,4 +1,1/-0,8	M 12	17,7	17,7	31,7	1300
M 6	91,0 +0/-2	97,0	103,3	17	6,4 +1,1/-0,8	M 12	17,7	17,7	31,7	750
M 6	91,0 +0/-2	144,5	149,8	17	6,4 +1,1/-0,8	M 12	17,7	17,7	31,7	1200
M 6	91,0 +0/-2	221,0	226,3	17	6,4 +1,1/-0,8	M 12	17,7	17,7	31,7	1900

Dimensions are also valid for 2-pad solution and low-inductance design.

Packing

For ecological reasons the packing is pure cardboard.

Capacitor diameter d	Packing units (pieces)	Capacitor diameter d	Packing units (pieces)
51,6 mm	22	76,9 mm	12
64,3 mm	15	91,0 mm	8

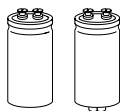

B43564 / B43584

Long Useful Life – 85 °C

Special designs

- Low-inductance design
- 2-pad solution
 Design for optimized connection of the capacitor to the heatsink when using base cooling. This version is available for capacitors without threaded stud and for diameters $\geq 64,3$ mm (cf. $I-R(B)$ in table “Technical data and ordering codes” and useful life graphs).

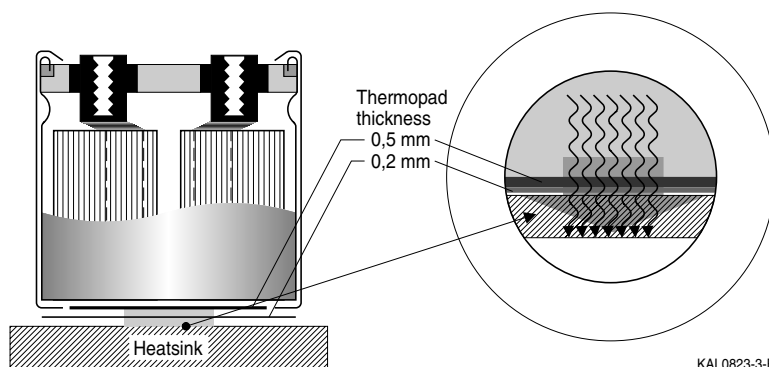

KAL0823-3-E

Ordering codes:

Design	Identification in 3rd block of ordering code	Remark
Low inductance (13 nH)	M003	For capacitors with diameter $d \geq 64,3$ mm
2-pad solution	M006	For capacitors with diameter $d \geq 64,3$ mm and without threaded stud

Accessories

The following items are included in the delivery package, but are not fastened to the capacitors:

	Thread	Toothed washers	Screws/Nuts	Maximum torque
For terminals	M 5	A 5,1 DIN 6797	Cylinder-head screw M 5 \times 8 DIN 84-4.8	2 Nm
	M 6	A 6,4 DIN 6797	Cylinder-head screw M 6 \times 12 DIN 85-4.8	2,5 Nm
For mounting	M 12	J 12,5 DIN 6797	Hex nut BM 12 DIN 439	10 Nm

The following must be ordered separately:

- Ring clips B44030 (cf. page 169)
- Clamps for capacitors with $d \geq 64,3$ mm B44030 (cf. page 173)
- Insulating parts B44020 (cf. page 166)



B43564 / B43584

Long Useful Life – 85 °C

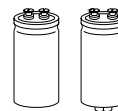

Overview of available types

U_R (VDC)	350	400	450	500
C_R (μ F)	Case dimensions $d \times l$ (mm)			
820				51,6 × 80,7
1 000	51,6 × 80,7	51,6 × 80,7	51,6 × 105,7	
1 200				51,6 × 105,7
1 500	51,6 × 105,7	51,6 × 105,7	64,3 × 105,7	
1 800				64,3 × 105,7
2 200	51,6 × 105,7	64,3 × 105,7	76,9 × 105,7	
2 700				76,9 × 105,7
3 300	64,3 × 105,7	76,9 × 143,2	76,9 × 143,2	
3 900				76,9 × 143,2
4 700	76,9 × 105,7	91,0 × 97,0	76,9 × 220,7 91,0 × 144,5	
6 000	76,9 × 143,2	76,9 × 220,7	76,9 × 220,7	
6 800		91,0 × 144,5		
8 200	91,0 × 144,5			
10 000	76,9 × 220,7			

The capacitance and voltage ratings listed above are available in different cases upon request.
Other voltage and capacitance ratings are also available upon request.

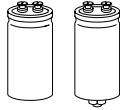

B43564 / B43584

Long Useful Life – 85 °C

Technical data and ordering codes

U_R	C_R	Case dimensions	ESR_{max}	Z_{max}	$I_{~max}$	$I_{~max}$	$I_{~R}$	$I_{~R}(B)$	Ordering code ¹⁾
VDC	100 Hz 20 °C μF	$d \times l$ mm	100 Hz 20 °C m Ω	10 kHz 20 °C m Ω	100 Hz 40 °C A	100 Hz 85 °C A	100 Hz 85 °C A	100 Hz 85 °C A	
350	1 000	51,6 × 80,7	130	120	14	6,4	5,1	8,8	B435*4A4108M000
	1 500	51,6 × 105,7	93	93	17	8,1	6,5	10	B435*4A4158M000
	2 200	51,6 × 105,7	72	66	21	10	8,0	14	B435*4B4228M000
	3 300	64,3 × 105,7	48	47	29	14	11	19	B435*4B4338M000 ²⁾
	4 700	76,9 × 105,7	38	38	36	17	13	25	B435*4B4478M000 ²⁾
	6 000	76,9 × 143,2	32	32	41	19	15	25	B435*4A4608M000 ²⁾
	8 200	91,0 × 144,5	23	23	57	27	21	36	B435*4A4828M000 ²⁾
	10 000	76,9 × 220,7	20	20	50	29	23	32	B435*4A4109M000 ²⁾
400	1 000	51,6 × 80,7	130	120	14	6,6	5,2	9,8	B435*4A0108M000
	1 500	51,6 × 105,7	93	81	18	7,7	6,7	11	B435*4A0158M000
	2 200	64,3 × 105,7	72	65	22	9,7	8,3	14	B435*4A0228M000 ²⁾
	3 300	76,9 × 143,2	54	51	29	13	11	16	B435*4A0338M000 ²⁾
	4 700	91,0 × 97,0	35	35	41	19	15	32	B435*4B0478M000 ²⁾
	6 000	76,9 × 220,7	32	32	44	21	16	22	B435*4A0608M000 ²⁾
	6 800	91,0 × 144,5	27	27	53	25	20	33	B435*4A0688M000 ²⁾
	450	1 000	51,6 × 105,7	140	130	15	6,9	5,4	8,9
1 500		64,3 × 105,7	99	89	19	8,9	7,0	12	B435*4A5158M000 ²⁾
2 200		76,9 × 105,7	72	65	25	12	9,2	16	B435*4A5228M000 ²⁾
3 300		76,9 × 143,2	51	49	32	15	12	19	B435*4A5338M000 ²⁾
4 700		76,9 × 220,7	38	38	42	20	16	20	B435*4A5478M000 ²⁾
4 700		91,0 × 144,5	38	38	46	21	17	28	B435*4J5478M000 ²⁾
6 000		76,9 × 220,7	32	32	49	23	18	25	B435*4A5608M000 ²⁾
500		820	51,6 × 80,7	195	177	11,9	4,4	4,4	8,6
	1 200	51,6 × 105,7	132	120	16,1	6,0	6,0	10,5	B435*4A6128M000
	1 800	64,3 × 105,7	89	80	21,1	7,9	7,9	13,7	B435*4A6188M000 ²⁾
	2 700	76,9 × 105,7	60	55	28,2	10,5	10,5	20,0	B435*4A6278M000 ²⁾
	3 900	76,9 × 143,2	42	38	38,2	14,2	14,2	23,7	B435*4A6398M000 ²⁾

1) * "6" = for capacitors with ring clip/clamp mounting
"8" = for capacitors with threaded stud

2) For 2-pad solution (types without threaded stud) and for low-inductance design, see page 136.



B43564 / B43584

Long Useful Life – 85 °C

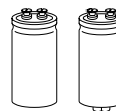

Useful life

depending on ambient temperature T_A (for natural cooling) and versus temperature of case base T_B (for base cooling) under ripple current operating conditions¹⁾

$U_R = 350 \dots 450 \text{ V}$

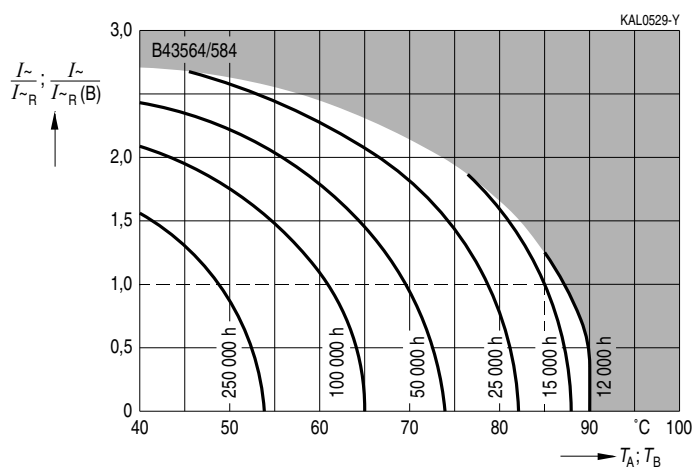

$U_R = 500 \text{ V}$

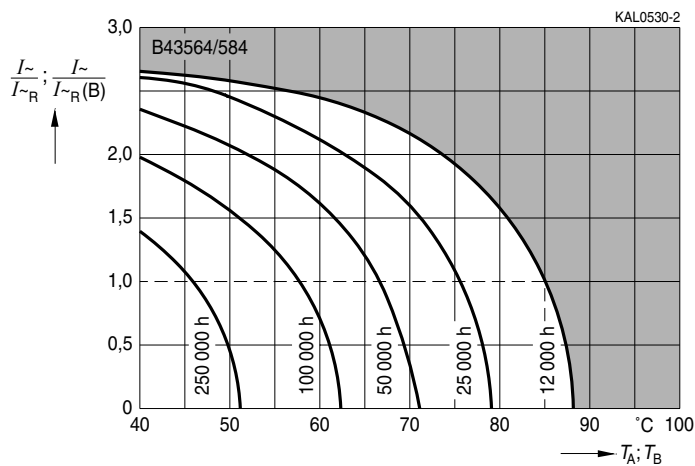

1) The ripple current refers to I_{-R} for natural cooling or to $I_{-R}(B)$ for base cooling, respectively. Refer to page 40 for an explanation on how to interpret the useful life graphs.

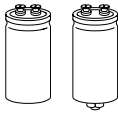

B43564 / B43584

Long Useful Life – 85 °C

Frequency factor of permissible ripple current I_{\sim} versus frequency f

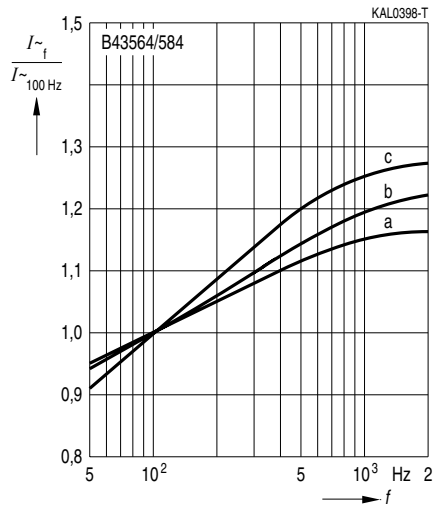

d (mm)	51,6	64,3	76,9	91,0
Curve	c	b	a	c

Frequency characteristics of ESR
Typical behavior

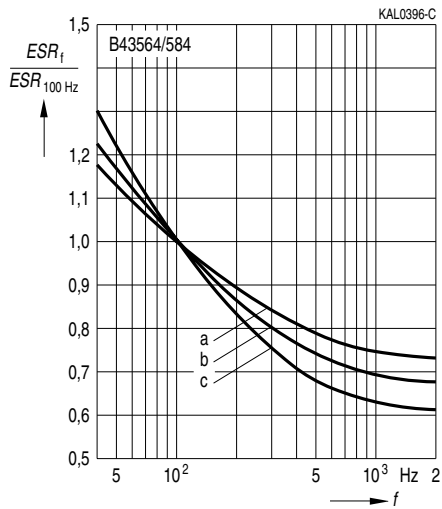

d (mm)	51,6	64,3	76,9	91,0
Curve	c	b	a	a



B43564 / B43584

Long Useful Life – 85 °C

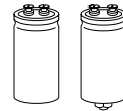

Impedance Z
versus frequency f
Typical behavior at 20 °C

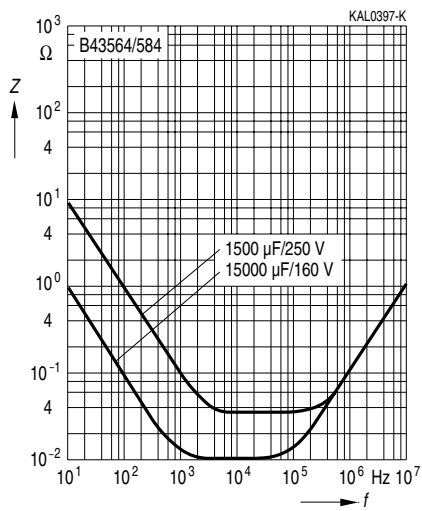

Herausgegeben von EPCOS AG

Unternehmenskommunikation, Postfach 80 17 09, 81617 München, DEUTSCHLAND

☎ ++49 89 636 09, FAX (0 89) 636-2 26 89

© EPCOS AG 2002. Vervielfältigung, Veröffentlichung, Verbreitung und Verwertung dieser Broschüre und ihres Inhalts ohne ausdrückliche Genehmigung der EPCOS AG nicht gestattet.

Bestellungen unterliegen den vom ZVEI empfohlenen Allgemeinen Lieferbedingungen für Erzeugnisse und Leistungen der Elektroindustrie, soweit nichts anderes vereinbart wird.

Diese Broschüre ersetzt die vorige Ausgabe.

Fragen über Technik, Preise und Liefermöglichkeiten richten Sie bitte an den Ihnen nächstgelegenen Vertrieb der EPCOS AG oder an unsere Vertriebsgesellschaften im Ausland. Bauelemente können aufgrund technischer Erfordernisse Gefahrstoffe enthalten. Auskünfte darüber bitten wir unter Angabe des betreffenden Typs ebenfalls über die zuständige Vertriebsgesellschaft einzuholen.

Published by EPCOS AG

Corporate Communications, P.O. Box 80 17 09, 81617 Munich, GERMANY

☎ ++49 89 636 09, FAX (0 89) 636-2 26 89

© EPCOS AG 2002. Reproduction, publication and dissemination of this brochure and the information contained therein without EPCOS' prior express consent is prohibited.

Purchase orders are subject to the General Conditions for the Supply of Products and Services of the Electrical and Electronics Industry recommended by the ZVEI (German Electrical and Electronic Manufacturers' Association), unless otherwise agreed.

This brochure replaces the previous edition.

For questions on technology, prices and delivery please contact the Sales Offices of EPCOS AG or the international Representatives.

Due to technical requirements components may contain dangerous substances. For information on the type in question please also contact one of our Sales Offices.

X-ON Electronics

Largest Supplier of Electrical and Electronic Components

Click to view similar products for [EPCOS](#) manufacturer:

Other Similar products are found below :

[B82432X001](#) [B41456B4479M](#) [B25673A5082A320](#) [B32652A223K](#) [B43501B3337M7](#) [B72280B0421K001](#) [B82721A2202N001](#)

[B84144A0120R000](#) [B84144A90R120](#) [B84243A8008W](#) [BR6000-R6](#) [B25631A1506K200](#) [B32656T684K](#) [B32686A7104K](#) [B32913A5154M](#)

[B41550E7229Q000](#) [B43252A5476M](#) [B64290A0045X038](#) [B66367G0200X187](#) [B72240B321K1](#) [B72280B0321K001](#) [B82432A1105K](#)

[B82442T1474K050](#) [B82477P4332M000](#) [B84144A50R](#) [B32673P6474K000](#) [B32914A3474M](#) [B41231A4109M000](#) [B43504B2108M000](#)

[B43508A9827M](#) [B57999V5999J099](#) [B59001Z999A99](#) [B65517D250J48](#) [B65686AR27](#) [B65687A1018T1](#) [B66367G2000X187](#)

[B84143A20R106](#) [B84144A0036R120](#) [B84144A66R120](#) [B86301U24R](#) [B32522C3105J](#) [B32560J3224K000](#) [B32654A224J](#)

[B43505C9337M000](#) [B43564B9228M000](#) [B43644B5277M000](#) [B58031I5105M002](#) [B66395G0000X187](#) [B82432X2](#) [B82477P4684M000](#)