



SMT inductors

SIMID series, SIMID 0805-F3

Series/Type: **B82498F3*001**

Date: September 2019

SMD

Size 0805 (EIA) and/or 2012 (IEC)

Rated inductance 2.7 ... 820 nH

Rated current 180 ... 1000 mA

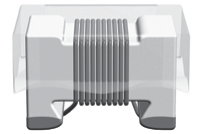

Construction

- Cubic coil with ceramic core
- Epoxy-molded flat top for vacuum pickup
- Winding ends welded to terminals

Features

- Temperature range up to +125 °C
- High resonance frequency
- Narrow inductance tolerance
- Suitable for lead-free reflow soldering as referenced in JEDEC J-STD 020D
- RoHS-compatible
- Qualified to AEC-Q200

Applications

Resonant circuits, impedance matching for

- Antenna amplifiers
- Multimedia
- Wireless communication systems
- Automotive electronics
- GPS (Global Positioning System)
- Low-pass filters for data lines

Terminals

- Base material Al₂O₃ ceramic
- Layer composition W/Ni/Au
- Electro-plated

Marking

- No marking on component
- Minimum data on reel:
Manufacturer, ordering code, L value, quantity, date of packing

Delivery mode and packing unit

- 8-mm blister tape, wound on 180-mm reel
- Packing unit: 3000 pcs./reel

SMD

Dimensional drawing and layout recommendation

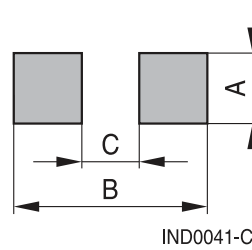

A	B	C
1.5 ±0.2	3.2 ±0.4	1.0 ±0.1

- 1) Soldering area
- 2) This area (30% of contact area) should not be used to assess solderability

IND0542-S-E

Dimensions in mm

Taping and packing

Blister tape

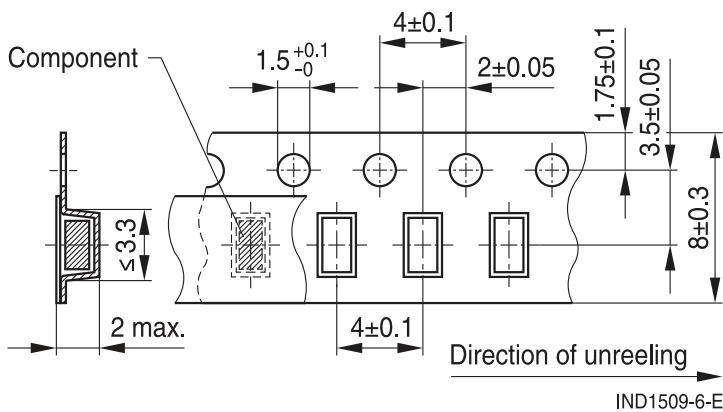

Reel

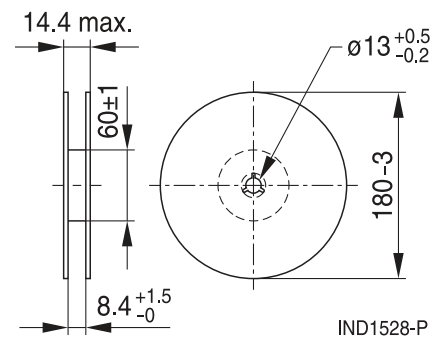

Dimensions in mm

SMD
Technical data and measuring conditions

Rated inductance L_R	Measured with impedance analyzer Agilent E4991A or equivalent at frequency f_L , 0.1 V, +20 °C
Q factor Q_{\min}	Measured with impedance analyzer Agilent E4991A or equivalent at frequency f_Q , +20 °C
Rated temperature T_R	+105 °C
Rated current I_R	Maximum permissible DC with inductance decrease $\Delta L/L_0 \leq 10\%$ and temperature increase of ≤ 20 K at rated temperature
Self-resonance frequency $f_{\text{res},\min}$	Measured with network analyzer Agilent E8362B and/or Agilent E4991A or equivalent, +20 °C
DC resistance R_{\max}	Measured at +20 °C
Solderability (lead-free)	Sn95.5Ag3.8Cu0.7: +(245 ±5) °C, (5 ±0.3) s Wetting of soldering area $\geq 90\%$ (based on IEC 60068-2-58)
Resistance to soldering heat	+260 °C, 40 s (as referenced in JEDEC J-STD 020D)
Climatic category	55/125/56 (to IEC 60068-1)
Storage conditions	Mounted: -55 °C ... +125 °C Packaged: -25 °C ... +40 °C, $\leq 75\%$ RH
Weight	Approx. 10 mg

SMD
Characteristics and ordering codes

L_R nH	Tolerance	f_L MHz	Q_{min}	f_Q MHz	I_R mA	R_{max} Ω	$f_{res,min}$ MHz	Ordering code ¹⁾
2.7	$\pm 10\% \triangleq K$	250	50	1500	1000	0.03	9000	B82498F3279K001
5.6		250	50	1000	900	0.04	7000	B82498F3569K001
6.8		250	50	1000	800	0.05	6000	B82498F3689K001
8.2		250	50	1000	700	0.09	5000	B82498F3829K001
10	$\pm 2\% \triangleq G$	250	50	500	700	0.09	5000	B82498F3100+001
12		$\pm 5\% \triangleq J$	250	50	500	700	0.09	4000
15			250	50	500	650	0.13	3300
18		250	60	500	700	0.08	3300	B82498F3180+001
22		250	60	500	700	0.08	2500	B82498F3220+001
27		250	60	500	700	0.09	2500	B82498F3270+001
33		250	65	500	600	0.11	2200	B82498F3330+001
39		250	65	500	600	0.12	2100	B82498F3390+001
47		200	65	500	600	0.13	2000	B82498F3470+001
56		200	60	500	600	0.14	1700	B82498F3560+001
68		200	60	500	500	0.18	1600	B82498F3680+001
82		150	60	500	500	0.19	1500	B82498F3820+001
100		150	55	500	450	0.28	1350	B82498F3101+001
120		150	50	250	440	0.31	1250	B82498F3121+001
150		100	45	250	400	0.42	1150	B82498F3151+001
180		100	45	250	340	0.53	1050	B82498F3181+001
220		100	45	250	320	0.70	950	B82498F3221+001
270		100	45	250	270	1.0	900	B82498F3271+001
330		100	45	250	220	1.5	800	B82498F3331+001
390		100	40	250	210	1.6	700	B82498F3391+001
470		50	30	100	190	1.9	650	B82498F3471+001
560		25	23	50	230	1.3	400	B82498F3561+001
680		25	23	50	190	1.7	300	B82498F3681+001
820		25	23	50	180	1.9	300	B82498F3821+001

1) Replace the + by the code letter for the required inductance tolerance.

SIMID 0805-F3

SMD

Impedance $|Z|$ vs. frequency f
 measured with impedance analyzer
 Agilent E4991A, typical values at +20 °C

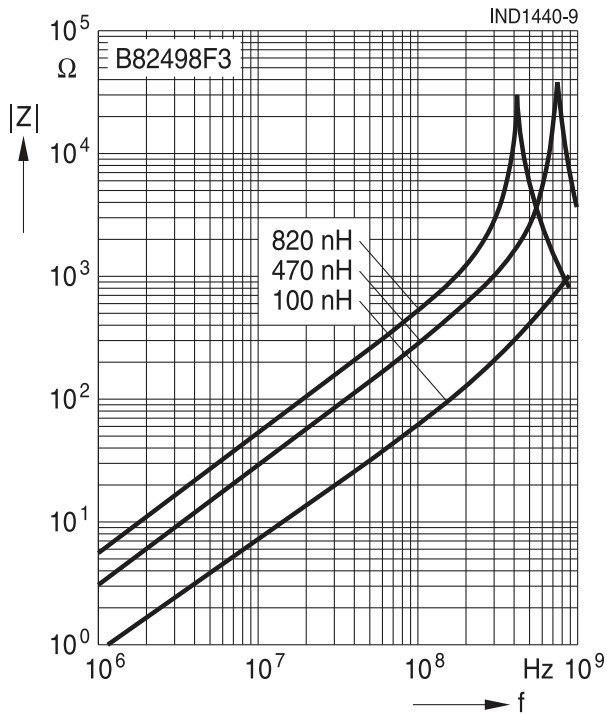

Q factor versus frequency f
 measured with impedance analyzer
 Agilent E4991A, typical values at +20 °C

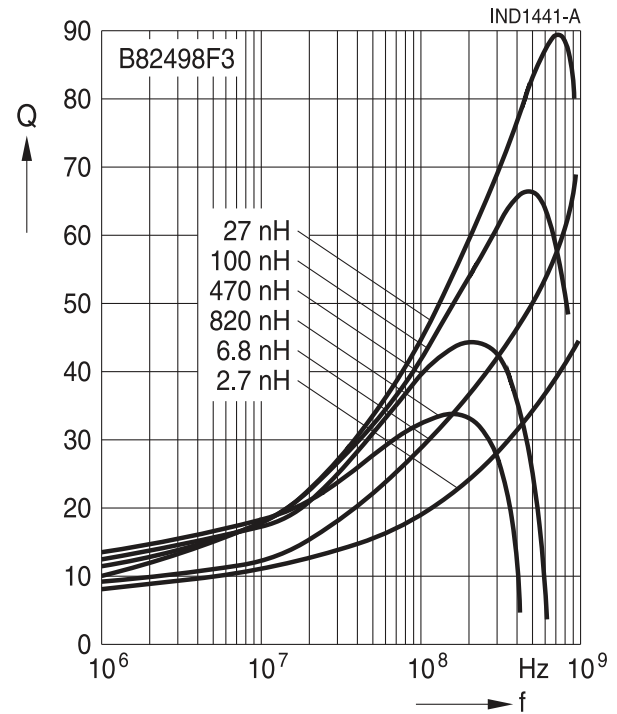

Inductance L versus DC load current I_{DC}
 measured with RF LCR meter
 Agilent 4285A, typical values at +20 °C

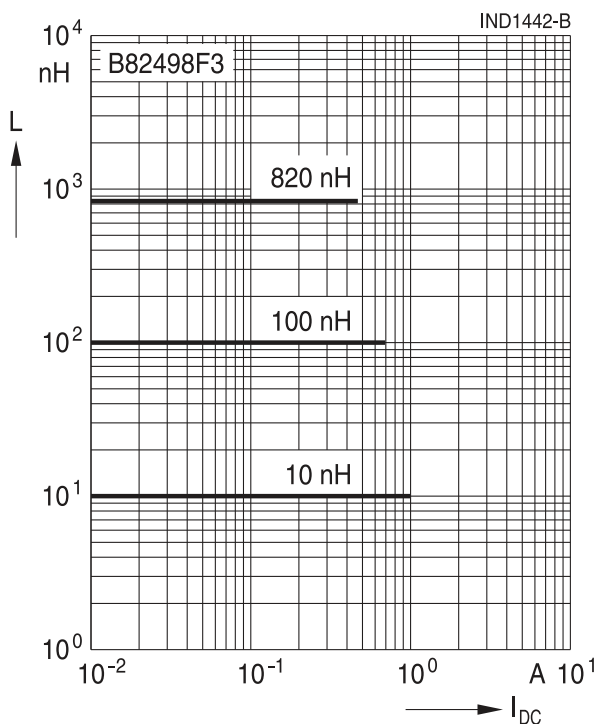

Current derating I_{op}/I_R
 versus ambient temperature T_A
 (rated temperature $T_R = +105$ °C)

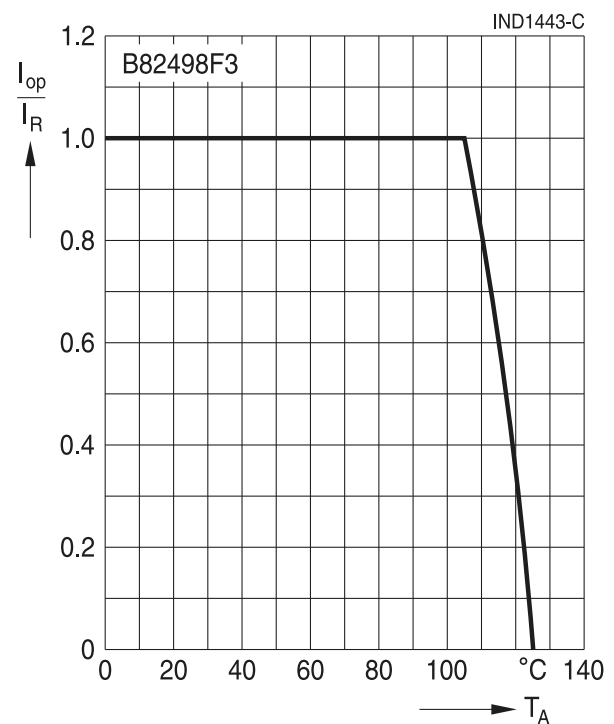

Cautions and warnings

- Please note the recommendations in our Inductors data book (latest edition) and in the data sheets.
 - Particular attention should be paid to the derating curves given there.
 - The soldering conditions should also be observed. Temperatures quoted in relation to wave soldering refer to the pin, not the housing.
- If the components are to be washed varnished it is necessary to check whether the washing varnish agent that is used has a negative effect on the wire insulation, any plastics that are used, or on glued joints. In particular, it is possible for washing varnish agent residues to have a negative effect in the long-term on wire insulation.
Washing processes may damage the product due to the possible static or cyclic mechanical loads (e.g. ultrasonic cleaning). They may cause cracks to develop on the product and its parts, which might lead to reduced reliability or lifetime.
- The following points must be observed if the components are potted in customer applications:
 - Many potting materials shrink as they harden. They therefore exert a pressure on the plastic housing or core. This pressure can have a deleterious effect on electrical properties, and in extreme cases can damage the core or plastic housing mechanically.
 - It is necessary to check whether the potting material used attacks or destroys the wire, wire insulation, plastics or glue.
 - The effect of the potting material can change the high-frequency behaviour of the components.
 - Many coating materials have a negative effect (chemically and mechanically) on the winding wires, insulation materials and connecting points. Customers are always obligated to determine whether and to what extent their coating materials influence the component.
Customers are responsible and bear all risk for the use of the coating material. TDK Electronics does not assume any liability for failures of our components that are caused by the coating material.
- Ceramics / ferrites are sensitive to direct impact. This can cause the core material to flake, or lead to breakage of the core.
- Even for customer-specific products, conclusive validation of the component in the circuit can only be carried out by the customer.

Display of ordering codes for TDK Electronics products

The ordering code for one and the same product can be represented differently in data sheets, data books, other publications, on the company website, or in order-related documents such as shipping notes, order confirmations and product labels. **The varying representations of the ordering codes are due to different processes employed and do not affect the specifications of the respective products.** Detailed information can be found on the Internet under www.tdk-electronics.tdk.com/orderingcodes.

Important notes

The following applies to all products named in this publication:

1. Some parts of this publication contain **statements about the suitability of our products for certain areas of application**. These statements are based on our knowledge of typical requirements that are often placed on our products in the areas of application concerned. We nevertheless expressly point out **that such statements cannot be regarded as binding statements about the suitability of our products for a particular customer application**. As a rule, we are either unfamiliar with individual customer applications or less familiar with them than the customers themselves. For these reasons, it is always ultimately incumbent on the customer to check and decide whether a product with the properties described in the product specification is suitable for use in a particular customer application.
2. We also point out that **in individual cases, a malfunction of electronic components or failure before the end of their usual service life cannot be completely ruled out in the current state of the art, even if they are operated as specified**. In customer applications requiring a very high level of operational safety and especially in customer applications in which the malfunction or failure of an electronic component could endanger human life or health (e.g. in accident prevention or life-saving systems), it must therefore be ensured by means of suitable design of the customer application or other action taken by the customer (e.g. installation of protective circuitry or redundancy) that no injury or damage is sustained by third parties in the event of malfunction or failure of an electronic component.
3. **The warnings, cautions and product-specific notes must be observed.**
4. In order to satisfy certain technical requirements, **some of the products described in this publication may contain substances subject to restrictions in certain jurisdictions (e.g. because they are classed as hazardous)**. Useful information on this will be found in our Material Data Sheets on the Internet (www.tdk-electronics.tdk.com/material). Should you have any more detailed questions, please contact our sales offices.
5. We constantly strive to improve our products. Consequently, **the products described in this publication may change from time to time**. The same is true of the corresponding product specifications. Please check therefore to what extent product descriptions and specifications contained in this publication are still applicable before or when you place an order.
We also **reserve the right to discontinue production and delivery of products**. Consequently, we cannot guarantee that all products named in this publication will always be available. The aforementioned does not apply in the case of individual agreements deviating from the foregoing for customer-specific products.
6. Unless otherwise agreed in individual contracts, **all orders are subject to our General Terms and Conditions of Supply**.

Important notes

7. **Our manufacturing sites serving the automotive business apply the IATF 16949 standard.**
The IATF certifications confirm our compliance with requirements regarding the quality management system in the automotive industry. Referring to customer requirements and customer specific requirements (“CSR”) TDK always has and will continue to have the policy of respecting individual agreements. Even if IATF 16949 may appear to support the acceptance of unilateral requirements, we hereby like to emphasize that **only requirements mutually agreed upon can and will be implemented in our Quality Management System.** For clarification purposes we like to point out that obligations from IATF 16949 shall only become legally binding if individually agreed upon.
8. The trade names EPCOS, CeraCharge, CeraDiode, CeraLink, CeraPad, CeraPlas, CSMP, CTVS, DeltaCap, DigiSiMic, ExoCore, FilterCap, FormFit, LeaXield, MiniBlue, MiniCell, MKD, MKK, MotorCap, PCC, PhaseCap, PhaseCube, PhaseMod, PhiCap, PowerHap, PQSine, PQvar, SIFERRIT, SIFI, SIKOREL, SilverCap, SIMDAD, SiMic, SIMID, SineFormer, SIOV, ThermoFuse, WindCap are **trademarks registered or pending** in Europe and in other countries. Further information will be found on the Internet at www.tdk-electronics.tdk.com/trademarks.

Release 2018-10

X-ON Electronics

Largest Supplier of Electrical and Electronic Components

Click to view similar products for [Fixed Inductors](#) category:

Click to view products by [EPCOS](#) manufacturer:

Other Similar products are found below :

[MLZ1608M6R8WTD25](#) [MLZ1608N6R8LT000](#) [MLZ1608N3R3LTD25](#) [MLZ1608N3R3LT000](#) [MLZ1608N150LT000](#)

[MLZ1608M150WTD25](#) [MLZ1608M3R3WTD25](#) [MLZ1608M3R3WT000](#) [MLZ1608M150WT000](#) [MLZ1608A1R5WT000](#)

[MLZ1608N1R5LT000](#) [B82432C1333K000](#) [PCMB053T-1R0MS](#) [PCMB053T-1R5MS](#) [PCMB104T-1R5MS](#) [CR32NP-100KC](#) [CR32NP-](#)

[151KC](#) [CR32NP-180KC](#) [CR32NP-181KC](#) [CR32NP-1R5MC](#) [CR32NP-390KC](#) [CR32NP-3R9MC](#) [CR32NP-680KC](#) [CR32NP-820KC](#)

[CR32NP-8R2MC](#) [CR43NP-390KC](#) [CR43NP-560KC](#) [CR43NP-680KC](#) [CR54NP-181KC](#) [CR54NP-470LC](#) [CR54NP-820KC](#) [CR54NP-8R5MC](#)

[MGDQ4-00004-P](#) [MGDU1-00016-P](#) [MHL1ECTTP18NJ](#) [MHL1JCTTD12NJ](#) [PE-51506NL](#) [PE-53601NL](#) [PE-53630NL](#) [PE-53824SNLT](#) [PE-](#)

[62892NL](#) [PE-92100NL](#) [PG0434.801NLT](#) [PG0936.113NLT](#) [PM06-2N7](#) [PM06-39NJ](#) [HC2LP-R47-R](#) [HC2-R47-R](#) [HC3-2R2-R](#) [HC8-1R2-R](#)