

REAL TIME CLOCK MODULE (4-bit)

RTC-7301SF

- Built-in crystal unit 32.768 kHz with frequency adjusted
- High speed parallel interface compatible with SRAM
- Built-in alarm and timer interrupt functions.
- Built-in semiconductor temperature sensor (Voltage output: -7.8 mV / °C)
- Frequency selectable clock output (32.768 kHz to 1/30 Hz)
- Built-in 30 second adjustment function, digital pace adjustment function (Max. adjustment: $\pm 192 \times 10^{-6}$)
- Operating voltage range: 2.4 V to 5.5 V, time keeping voltage range: 1.6 V to 5.5 V
- Low current consumption (0.6 μ A / 3 V Typ.)



Product Number (Please contact us)
RTC-7301SF : Q42730181000200

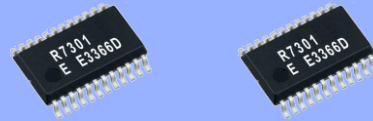

Actual size

RTC-7301SF



Block diagram

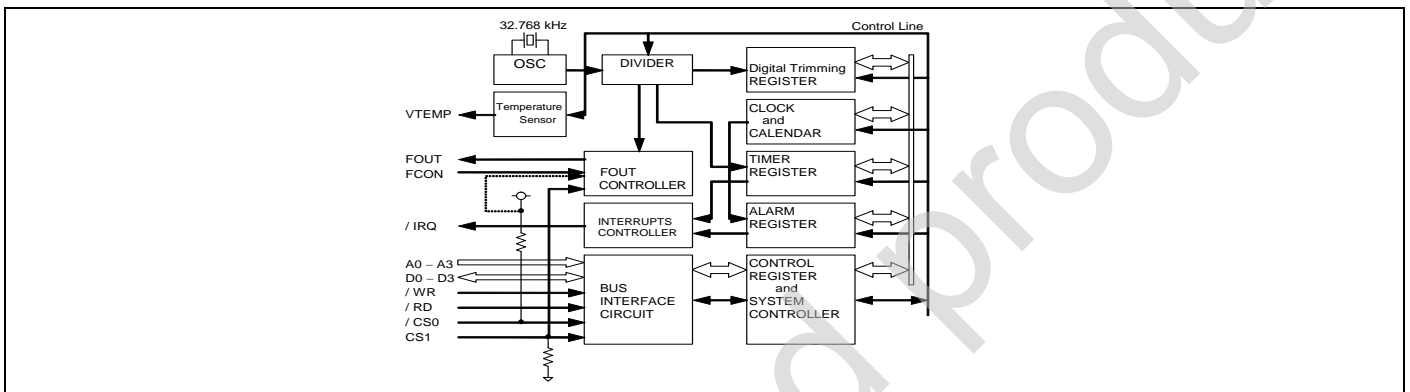

External dimensions/Terminal connection

(Unit:mm)

● RTC-7301SF (SSOP 24-pin)

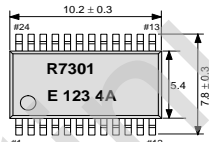

No.	Pin terminal	No.	Pin terminal
1	/CS0	24	V _{DD}
2	FCOIN	23	(V _{DD})
3	FOUT	22	(V _{DD})
4	VTEMP	21	(V _{DD})
5	(V _{DD})	20	(V _{DD})
6	/IRQ	19	(V _{DD})
7	A ₀	18	CS ₁
8	A ₁	17	D ₀
9	A ₂	16	D ₁
10	A ₃	15	D ₂
11	/RD	14	D ₃
12	GND	13	/WR

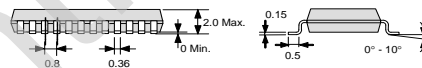

The metal case inside of the molding compound may be exposed on the top or bottom of this product. This purely cosmetic and does not have any effect on quality, reliability or electrical specs.

Specifications (characteristics)

*Refer to application manual for details.

■ Absolute Max. rating

GND=0 V

Item	Symbol	Conditions	Min.	Max.	Unit
Supply voltage	V _{DD}	V _{DD} to GND	-0.3	+7.0	
Input voltage	V _{IN}	Input terminal, D ₀ to D ₃ pins	GND-0.3	V _{DD} +0.3	V
Output voltage(1)	V _{OUT1}	/IRQ pin		+8.0	
Output voltage(2)	V _{OUT2}	FOUT, D ₀ -D ₃ , VTEMP pin		V _{DD} +0.3	
Storage temperature	T _{STG}	Stored as bare product.	-55	+125	°C

■ DC characteristics

(GND=0 V, V_{DD}=1.6 V to 5.5 V, T_a=-40 °C to +85 °C)

Item	Symbol	Conditions	Min.	Typ.	Max.	Unit
Current consumption (When non-accessed) FOUT =Output OFF VTEMP=Output OFF	I _{DD1}	/CS ₀ ,/RD,/WR=V _{DD} A ₀ -A ₃ ,CS ₁ =GND D ₀ -D ₃ ,/IRQ=Hi-z FOUT=Hi-z(OFF) VTEMP=Hi-z(OFF)				μ A
	I _{DD2}	V _{DD} =5 V		1.0	2.0	
		V _{DD} =3 V		0.6	1.0	

■ Operating range

GND = 0 V

Item	Symbol	Conditions	Min.	Max.	Unit
Power voltage	V _{DD}	—	2.4	5.5	V
Clock voltage	V _{CLK}	—	1.6	5.5	V
Operating temperature	T _{OPR}	No condensation	-40	+85	°C

■ Temperature sensor characteristics

GND=0 V, T_a=-40 °C to +85 °C

Item	Symbol	Conditions	Min.	Typ.	Max.	Unit
Temperature output voltage	VTEMP	T _a =+25 °C, GND based output voltage VTEMP pins, V _{DD} =2.7 V to 5.5 V	-	1.470	-	V
Output precision	T _{ACR}	T _a =+25 °C, V _{DD} =2.7 V to 5.5 V	-	-	±5.0	°C
Temperature sensitivity	VSE	-40 °C ≤ T _a ≤ +85 °C, V _{DD} =2.7 V to 5.5 V	-7.3	-7.8	-8.3	mV/°C
Linearity	ΔNL	-40 °C ≤ T _a ≤ +85 °C, V _{DD} =2.7 V to 5.5 V	-	-	±2.0	%
Temperature detection range	T _{SOP}	ΔNL ≤ ±2.0 %, V _{DD} =2.7 V to 5.5 V	-40	-	+85	°C
Output resistance	R ₀	T _a =25 °C, VTEMP pins, V _{DD} =2.7 V to 5.5 V GND standard and V _{DD} standard	-	1.0	3.0	kΩ
Load condition	CL	V _{DD} =2.7 V to 5.5 V	-	-	100	pF
	R _L	V _{DD} =2.7 V to 5.5 V	500	-	-	kΩ
Response time	t _{RSP}	V _{DD} =3.3 V C _L =50 pF, R _L =500 kΩ, Max. ±1 °C	-	-	200	μs

■ Frequency characteristics

Item	Symbol	Conditions	Range	Unit
Frequency precision	Δf/f	T _a =+25 °C, V _{DD} =3.0 V	B: 5±23 ^(*)	×10 ⁻⁶
Oscillation Start up time	t _{STA}	T _a =+25 °C, V _{DD} =2.4 V	3.0 Max.	s
Frequency temperature characteristics	T _{OP}	T _a =-10 °C to +70 °C V _{DD} =3.0 V, +25 °C	+10 / -120	×10 ⁻⁶
Frequency voltage characteristics	f/V	T _a =+25 °C, V _{DD} =1.6 V to 5.5 V	±2.0 Max.	×10 ⁻⁶ /V
Aging	f _a	T _a =+25 °C, V _{DD} =3.0 V First year	±5.0 Max.	×10 ⁻⁶ /year

(*) Please ask tighter tolerance

PROMOTION OF ENVIRONMENTAL MANAGEMENT SYSTEM CONFORMING TO INTERNATIONAL STANDARDS

At Seiko Epson, all environmental initiatives operate under the Plan-Do-Check-Action (PDCA) cycle designed to achieve continuous improvements. The environmental management system (EMS) operates under the ISO 14001 environmental management standard.

All of our major manufacturing and non-manufacturing sites, in Japan and overseas, completed the acquisition of ISO 14001 certification.

ISO 14000 is an international standard for environmental management that was established by the International Standards Organization in 1996 against the background of growing concern regarding global warming, destruction of the ozone layer, and global deforestation.





WORKING FOR HIGH QUALITY

In order provide high quality and reliable products and services than meet customer needs,

Seiko Epson made early efforts towards obtaining ISO9000 series certification and has acquired ISO9001 for all business establishments in Japan and abroad. We have also acquired ISO/TS 16949 certification that is requested strongly by major automotive manufacturers as standard.

ISO/TS16949 is the international standard that added the sector-specific supplemental requirements for automotive industry based on ISO9001.

► Explanation of the mark that are using it for the catalog

	► Pb free.
	► Complies with EU RoHS directive. *About the products without the Pb-free mark. Contains Pb in products exempted by EU RoHS directive. (Contains Pb in sealing glass, high melting temperature type solder or other.)
	► Designed for automotive applications such as Car Multimedia, Body Electronics, Remote Keyless Entry etc.
	► Designed for automotive applications related to driving safety (Engine Control Unit, Air Bag, ESC etc).

Notice

- This material is subject to change without notice.
- Any part of this material may not be reproduced or duplicated in any form or any means without the written permission of Seiko Epson.
- The information about applied data, circuitry, software, usage, etc. written in this material is intended for reference only. Seiko Epson does not assume any liability for the occurrence of customer damage or infringing on any patent or copyright of a third party. This material does not authorize the licensing for any patent or intellectual copyrights.
- When exporting the products or technology described in this material, you should comply with the applicable export control laws and regulations and follow the procedures required by such laws and regulations.
- You are requested not to use the products (and any technical information furnished, if any) for the development and/or manufacture of weapon of mass destruction or for other military purposes. You are also requested that you would not make the products available to any third party who may use the products for such prohibited purposes.
- These products are intended for general use in electronic equipment. When using them in specific applications that require extremely high reliability, such as the applications stated below, you must obtain permission from Seiko Epson in advance.
/ Space equipment (artificial satellites, rockets, etc.) / Transportation vehicles and related (automobiles, aircraft, trains, vessels, etc.) / Medical instruments to sustain life / Submarine transmitters / Power stations and related / Fire work equipment and security equipment / traffic control equipment / and others requiring equivalent reliability.
- All brands or product names mentioned herein are trademarks and/or registered trademarks of their respective.

X-ON Electronics

Largest Supplier of Electrical and Electronic Components

Click to view similar products for [Real Time Clock](#) category:

Click to view products by [Epson](#) manufacturer:

Other Similar products are found below :

[DS1302Z-LF](#) [710029X](#) [879047C](#) [405800G](#) [PT7C43390LE](#) [RV-3029-C2-32.768k-OPTION-B-TB-QA](#) [RV-2123-C2-32.768k-20PPM-TA-QA](#)
[RV-3029-C2-32.768k-OPTION-A-TB-QA](#) [PT7C4563UEX](#) [RV-3029-C3-32.768k-OPTION-A-TB-QA](#) [RV-2123-C2-32.768kHz-20PPM-TA-QC](#) [RX-4035LC:B3 PURE SN](#) [RX-8564LC:B PURE SN](#) [RX-8803LCUB PURE SN BULK](#) [BQ32002D](#) [RTC-8564JE](#) [MCP7940M-I/P](#)
[DS3231SN#T&R](#) [DS1391U-18+](#) [DS1347T+T&R](#) [RX-8564LC:B3 PURE SN](#) [DS1338Z-33+T](#) [RX-4571SA:B3 PURE SN](#) [DS1340U-33+T&R](#)
[RX-8571LC:B3 PURE SN](#) [S-35190A-J8T1U](#) [RTC-4543SAB](#) [RTC-72421A](#) [RX-8803LC:UB3 PURE SN](#) [S-35390A-T8T1](#) [AB1815-T3](#) [AB-RTCMC-32.768kHz-AIGZ-S7-T](#) [AB-RTCMC-32.768kHz-B5GA-S3-T](#) [AB-RTCMC-32.768kHz-B5ZE-S3-T](#) [AB-RTCMC-32.768kHz-EOA9-S3-D-B-T](#) [AB-RTCMC-32.768kHz-EOZ9-S3-D-B-T](#) [AB-RTCMC-32.768KHZ-EOZ9-S3-HAT](#) [AB-RTCMC-32.768kHz-ZIZE-S2-T](#)
[DS1672U-33+](#) [DS1337U+T&R](#) [DS1339AU+](#) [FM33256B-G](#) [DS1673E-5-LF](#) [DS1672U-3+](#) [DS1672U-33+T&R](#) [HYM1307N](#) [HYM1302](#)
[HYM1302N](#) [PCF8563N](#) [DS1302N](#)