

REAL TIME CLOCK MODULE (I²C-Bus)

High-Stability

RX - 8025 SA / NB

- Built-in 32.768 kHz crystal unit : Frequency adjusted for high accuracy ($\pm 5 \times 10^{-6}$ / $T_a = +25^\circ\text{C}$)
- Interface Type : I²C-Bus Interface (400 kHz)
- Operating voltage range : 1.70 V to 5.5 V
- Wide voltage for timekeeping : 1.15 V to 5.5 V
- Various detection Functions : Ex. Oscillation stop detection function
- Low backup current : 0.48 μA / 3 V (Typ.)
- 32.768 kHz frequency output function : C-MOS output with OE pin.
- The various functions include full calendar, Dual alarm, Periodic interruption.

* The I²C-Bus is a trademark of NXP Semiconductors



Product Number (Please contact us)
 RX-8025SA AA : Q41802552000100
 RX-8025SA AC : Q41802551000200
 RX-8025NB AA : Q41802592000100
 RX-8025NB AC : Q41802592000200

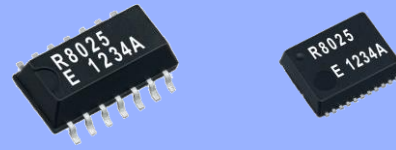

Actual size

RX-8025SA

RX-8025NB



Block diagram

Overview

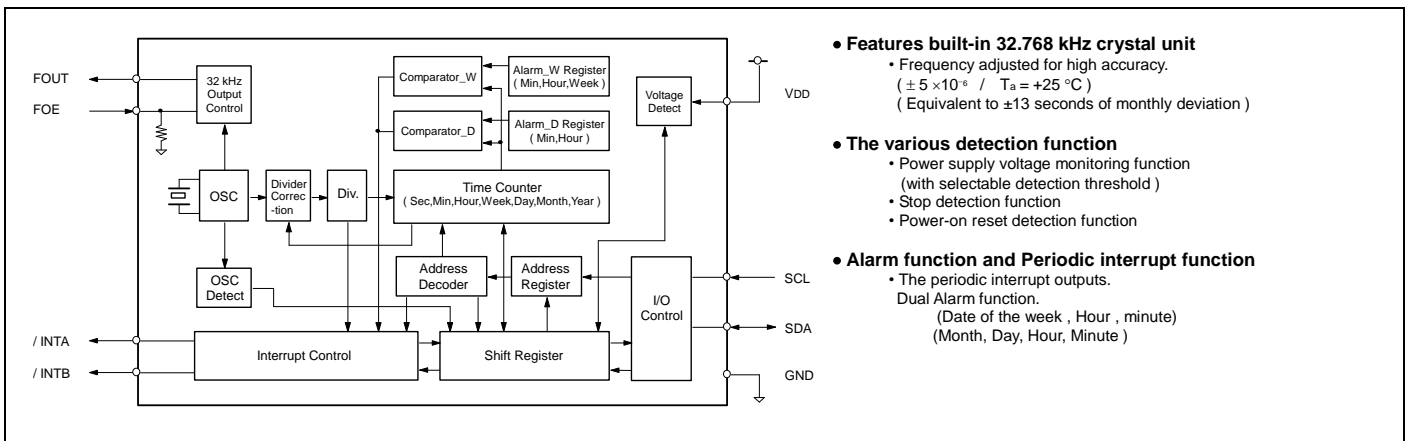

- **Features built-in 32.768 kHz crystal unit**
 - Frequency adjusted for high accuracy. ($\pm 5 \times 10^{-6}$ / $T_a = +25^\circ\text{C}$) (Equivalent to ± 13 seconds of monthly deviation)
- **The various detection function**
 - Power supply voltage monitoring function (with selectable detection threshold)
 - Stop detection function
 - Power-on reset detection function
- **Alarm function and Periodic interrupt function**
 - The periodic interrupt outputs. Dual Alarm function. (Date of the week , Hour , minute) (Month, Day, Hour, Minute)

Pin Function

Terminal connection / External dimensions

(Unit:mm)

Signal Name	Input / output	Function																					
SCL	Input	Serial clock input pin																					
SDA	Bi-directional	Data input and output pin																					
FOUT	Output	32.768 kHz clock output pin with the output control function. (C-MOS)																					
FOE	Input	<table border="1"> <thead> <tr> <th>FOE input</th> <th>/CLEN1 bit</th> <th>/CLEN2 bit</th> <th>FOUT output</th> </tr> </thead> <tbody> <tr> <td>L</td> <td>X</td> <td>X</td> <td>OFF (LOW)</td> </tr> <tr> <td rowspan="3">H</td> <td>0</td> <td>0</td> <td>32.768 kHz</td> </tr> <tr> <td>0</td> <td>1</td> <td>32.768 kHz</td> </tr> <tr> <td>1</td> <td>0</td> <td>32.768 kHz</td> </tr> <tr> <td>1</td> <td>1</td> <td>OFF(LOW)</td> </tr> </tbody> </table>	FOE input	/CLEN1 bit	/CLEN2 bit	FOUT output	L	X	X	OFF (LOW)	H	0	0	32.768 kHz	0	1	32.768 kHz	1	0	32.768 kHz	1	1	OFF(LOW)
FOE input	/CLEN1 bit	/CLEN2 bit	FOUT output																				
L	X	X	OFF (LOW)																				
H	0	0	32.768 kHz																				
	0	1	32.768 kHz																				
	1	0	32.768 kHz																				
1	1	OFF(LOW)																					
/INTA	Output	Interrupt output A pin (N-ch open drain)																					
/INTB	Output	Interrupt output B pin (N-ch open drain)																					
TEST	—	* Used by the manufacture for testing. (Do not connect externally.)																					
VDD	—	Connected to a positive power supply.																					
GND	—	Connected to a ground.																					

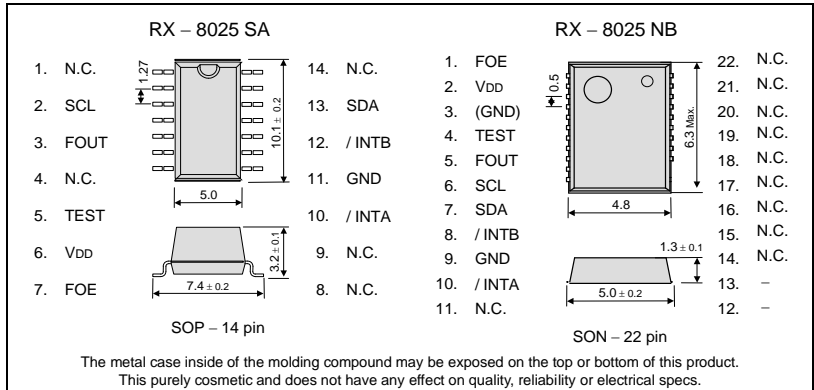

Specifications (characteristics)

* Refer to application manual for details.

Recommended Operating Conditions

Item	Symbol	Conditions	Min.	Typ.	Max.	Unit
Power voltage	VDD	—	1.7	3.0	5.5	V
Clock voltage	VCLK	—	1.15	3.0	5.5	V
Operating temperature	TOPR	—	-40	+25	+85	°C

Frequency characteristics

Item	Symbol	Conditions	Range	Unit
Frequency tolerance	$\Delta f / f$	$T_a = +25^\circ\text{C}$ VDD = 3.0 V	AA: 5 ± 5 *1) AC: 0 ± 5 *2)	$\times 10^{-6}$
Oscillation start-up time	tSTA	$T_a = +25^\circ\text{C}$ VDD = 2.0 V	1 Max.	s
Frequency voltage characteristics	f / V	$T_a = +25^\circ\text{C}$ VDD = 2.0 V to 5.5 V	± 1 Max.	$\times 10^{-6}$

*1) *2) Equivalent to ± 13 seconds of monthly deviation (excluding offset).

Current consumption characteristics

Item	Symbol	Conditions	Min.	Typ.	Max.	Unit	
Current Consumption	I _{BK}	f _{SCL} = 0Hz FOE = GND FOUT ; output OFF(LOW)	VDD = 5 V	-	0.60	1.80	μA
		VDD = 3 V	-	0.48	1.20	μA	
Current Consumption	I _{32k}	f _{SCL} = 0Hz VDD, FOE = 5.5 V FOUT ; output ON (Output=OPEN; CL = 0 pF)	VDD = 5.5 V	-	3.0	6.5	μA
		VDD = 3 V	-	3.0	6.5	μA	

Power supply detection voltage

Item	Symbol	Conditions	Min.	Typ.	Max.	Unit
High-voltage mode	VDETH	VDD pin	1.90	2.10	2.30	V
Low-voltage mode	VDETL	VDD pin	1.15	1.30	1.45	V

PROMOTION OF ENVIRONMENTAL MANAGEMENT SYSTEM CONFORMING TO INTERNATIONAL STANDARDS

At Seiko Epson, all environmental initiatives operate under the Plan-Do-Check-Action (PDCA) cycle designed to achieve continuous improvements. The environmental management system (EMS) operates under the ISO 14001 environmental management standard.

All of our major manufacturing and non-manufacturing sites, in Japan and overseas, completed the acquisition of ISO 14001 certification.

ISO 14000 is an international standard for environmental management that was established by the International Standards Organization in 1996 against the background of growing concern regarding global warming, destruction of the ozone layer, and global deforestation.





WORKING FOR HIGH QUALITY

In order provide high quality and reliable products and services than meet customer needs,

Seiko Epson made early efforts towards obtaining ISO9000 series certification and has acquired ISO9001 for all business establishments in Japan and abroad. We have also acquired ISO/TS 16949 certification that is requested strongly by major automotive manufacturers as standard.

ISO/TS16949 is the international standard that added the sector-specific supplemental requirements for automotive industry based on ISO9001.

► Explanation of the mark that are using it for the catalog

	► Pb free.
	► Complies with EU RoHS directive. *About the products without the Pb-free mark. Contains Pb in products exempted by EU RoHS directive. (Contains Pb in sealing glass, high melting temperature type solder or other.)
	► Designed for automotive applications such as Car Multimedia, Body Electronics, Remote Keyless Entry etc.
	► Designed for automotive applications related to driving safety (Engine Control Unit, Air Bag, ESC etc).

Notice

- This material is subject to change without notice.
- Any part of this material may not be reproduced or duplicated in any form or any means without the written permission of Seiko Epson.
- The information about applied data, circuitry, software, usage, etc. written in this material is intended for reference only. Seiko Epson does not assume any liability for the occurrence of customer damage or infringing on any patent or copyright of a third party. This material does not authorize the licensing for any patent or intellectual copyrights.
- When exporting the products or technology described in this material, you should comply with the applicable export control laws and regulations and follow the procedures required by such laws and regulations.
- You are requested not to use the products (and any technical information furnished, if any) for the development and/or manufacture of weapon of mass destruction or for other military purposes. You are also requested that you would not make the products available to any third party who may use the products for such prohibited purposes.
- These products are intended for general use in electronic equipment. When using them in specific applications that require extremely high reliability, such as the applications stated below, you must obtain permission from Seiko Epson in advance.
/ Space equipment (artificial satellites, rockets, etc.) / Transportation vehicles and related (automobiles, aircraft, trains, vessels, etc.) / Medical instruments to sustain life / Submarine transmitters / Power stations and related / Fire work equipment and security equipment / traffic control equipment / and others requiring equivalent reliability.
- All brands or product names mentioned herein are trademarks and/or registered trademarks of their respective.

X-ON Electronics

Largest Supplier of Electrical and Electronic Components

Click to view similar products for [Real Time Clock](#) category:

Click to view products by [Epson](#) manufacturer:

Other Similar products are found below :

[MCP79400T-IMS](#) [DS1315-5](#) [MCP79402-IMS](#) [MCP7940N-IP](#) [710029X](#) [MCP79400T-I/SN](#) [DS1683S+T&R](#) [DS1672U-2](#) [DS1374U-33T&R](#)
[DS1372U+T&R](#) [DS1308U-3+](#) [DS1338U-18+T&R](#) [879047C](#) [405800G](#) [DS1341U+T&R](#) [DS1374U-33](#) [MCP79400T-ISN](#) [DS1340U-3+T&R](#)
[MCP7940NT-E/MS](#) [PT7C43390LE](#) [DS1318E+T&R](#) [DS1342T+T&R](#) [PT7C4337ACSE](#) [RX8900SA](#) [UB3 PURE SN](#) [RV-3029-C2-32.768k-](#)
[OPTION-B-TB-QA](#) [RV-2123-C2-32.768k-20PPM-TA-QA](#) [RV-3029-C2-32.768k-OPTION-A-TB-QA](#) [RV-1805-C3-32.768kHz-2PPM-TA-QC](#)
[PT7C4337AWEX](#) [RX8130CE B0](#) [PT7C4563UEX](#) [PT7C4311WEX](#) [DS1374C-33#T&R](#) [RV-3029-C3-32.768k-OPTION-A-TB-QA](#) [RV-](#)
[2123-C2-32.768kHz-20PPM-TA-QC](#) [DS1308U-33+T](#) [DS1339U-3+T&R](#) [DS1339BU+T](#) [RX8900SA UC3 PURE SN](#) [PT7C4307WEX](#)
[DS1339AU+T](#) [DS1308U-18+T](#) [RX8804CE XA3](#) [RX8130CE BX](#) [DS1341T+T&R](#) [RX-8025SA](#) [MCP79401-I/ST](#) [MCP795W20-IST](#)
[MCP79400-I/ST](#) [MCP79401-I/SN](#)