

## Temperature Compensated Crystal Oscillator (TCXO)

- Package size (5.0 mm × 3.2 mm × 1.45 mm)
- Ultra high stability TCXO
- Output waveform : CMOS
- Reference weight Typ.72 mg

### [ 1 ] Product Number / Product Name

(1-1) Product Number / Ordering Code

**X1G0053910015xx**

last 2 digits code(xx) define Quantity.

The standard is "00", 1 000 pcs/Reel.

(1-2) Product Name / Model Name

**TG5032CFN 20.000000 MHz CAGNNA**

### [ 2 ] Operating range

Parameter	Symbol	Specifications			Unit	Conditions
		Min.	Typ.	Max.		
Supply voltage	V <sub>cc</sub>	3.135	3.3	3.465	V	-
	GND	0	-	0	V	-
Operating temperature range	T <sub>use</sub>	-40	-	+85	°C	-
Output load	Load <sub>C</sub>	13.5	15	16.5	pF	-

### [ 3 ] Frequency characteristics

(V<sub>cc</sub> = 3.3 V, GND = 0.0 V, Load = 15 pF, T<sub>use</sub> = +25 °C)

Parameter	Symbol	Specifications			Unit	Conditions
		Min.	Typ.	Max.		
Output Frequency	f <sub>o</sub>	-	20	-	MHz	-
Frequency tolerance *1	f <sub>tol</sub>	-1.0	-	+1.0	x10 <sup>-6</sup>	T <sub>use</sub> = +25 °C ±2 °C After 2 reflows *2
Frequency / temperature characteristics	f <sub>o</sub> -T <sub>c</sub>	-0.1	-	+0.1	x10 <sup>-6</sup>	T <sub>use</sub> = -40 °C to +85 °C (Reference to (f <sub>max</sub> +f <sub>min</sub> )/2)
Frequency / load coefficient	f <sub>o</sub> -Load	-0.1	-	+0.1	x10 <sup>-6</sup>	Load ±10 %
Frequency / voltage coefficient	f <sub>o</sub> -V <sub>cc</sub>	-0.1	-	+0.1	x10 <sup>-6</sup>	V <sub>cc</sub> ±5 %
Frequency aging	f <sub>age</sub>	-0.5	-	+0.5	x10 <sup>-6</sup>	T <sub>use</sub> = +25 °C first year
		-3.0	-	+3.0	x10 <sup>-6</sup>	T <sub>use</sub> = +25 °C 20 years
Holdover stability, constant temperature	-	-0.01	-	+0.01	x10 <sup>-6</sup>	T <sub>use</sub> = +25 °C, 24 hours (after 10 days of continuous operation)
Holdover stability, constant temperature	-	-0.04	-	+0.04	x10 <sup>-6</sup>	T <sub>use</sub> = +25 °C, 24 hours (after 48 hours of continuous operation)
Holdover stability (Free-run accuracy)	-	-4.6	-	+4.6	x10 <sup>-6</sup>	*3

\*1 Include initial frequency tolerance and frequency deviation after reflow cycles.

\*2 Measured in the elapse of 24 hours after reflow soldering.

\*3 This includes initial frequency tolerance, frequency / temperature characteristics, frequency / load coefficient, frequency/voltage coefficient and frequency aging (+25 °C, 20 years) .

### [ 4 ] Electrical characteristics

(V<sub>cc</sub> = 3.3 V, GND = 0.0 V, Load = 15 pF, T<sub>use</sub> = +25 °C)

Parameter	Symbol	Specifications			Unit	Conditions
		Min.	Typ.	Max.		
Current consumption	I <sub>cc</sub>	-	-	5.0	mA	V <sub>cc</sub> = 3.3 V
High level output voltage	V <sub>oH</sub>	90 % V <sub>cc</sub>	-	-	V	-
Low level output voltage	V <sub>oL</sub>	-	-	10 % V <sub>cc</sub>	V	-
Rise time	t <sub>r</sub>	-	-	8	ns	10 % V <sub>cc</sub> to 90 % V <sub>cc</sub> level
Fall time	t <sub>f</sub>	-	-	8	ns	90 % V <sub>cc</sub> to 10 % V <sub>cc</sub> level
Symmetry	SYM	45	-	55	%	50 % V <sub>cc</sub> Level

[ For other general specifications, please refer to the attached Full Data Sheet below ]

# Ultra high stability temperature compensated crystal oscillator

**Product name : TG5032CFN / TG5032SFN**

## Features

- Ultra high stability ( $\leq 0.1 \times 10^{-6}$ )
- Low phase noise
- Frequency range : 10 MHz to 40 MHz
- Output : CMOS, Clipped sine wave
- Supply voltage : 2.375 to 3.63 V
- External dimensions : 5.0 × 3.2 × 1.45 mm
- Small size package (4 pads)
- Pb free.
- Complies with EU RoHS directive.

## Applications

- Small Cells
- Stratum3
- Femtocell
- Network system etc..

## Outline dimensions

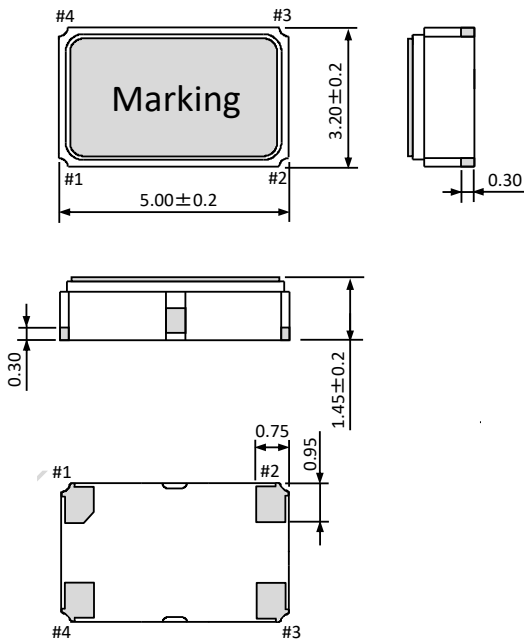

## Pin information

Pin	Connections	
	VC-TCXO	TCXO
1	V <sub>c</sub>	N.C.
2	GND	
3	OUT	
4	V <sub>cc</sub>	

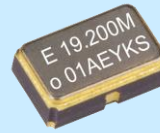

TG5032CFN (CMOS output)



TG5032SFN (Clipped sine wave output)

## Description

This product is ultra high stability temperature compensated crystal oscillator of CMOS and Clipped sine wave outputs using fundamental oscillation of Crystal unit. This has realized a low phase noise in frequency 10 to 40 MHz, and it is suitable for the reference clock include Small Cells.

This allows the product to be compliant with various standards including GR-1244-CORE Stratum3, G.8262.1, G.8273.2 (Class A,B).

## Characteristics

Frequency / temperature characteristics

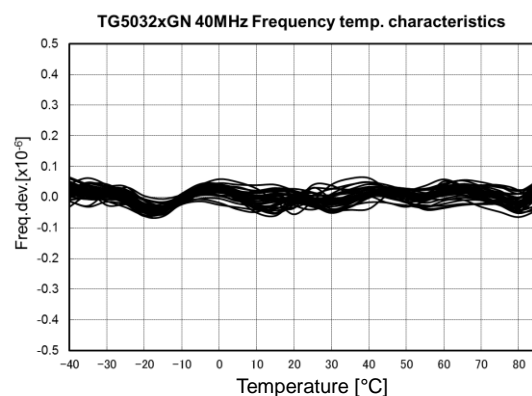
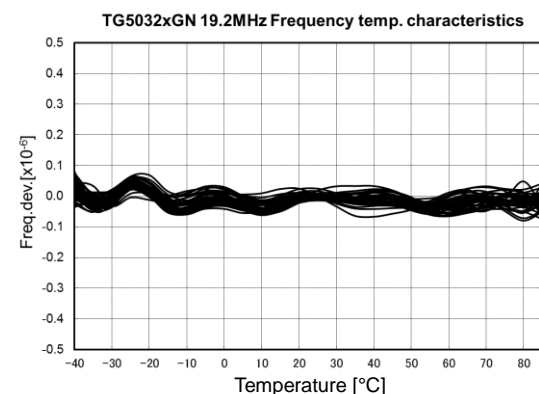

**1. Product Number / Product Name**

(1-1) Product Number / Ordering Code

TG5032CFN: X1G005391xxxx00 (Please contact Epson for details of number xxxx)

TG5032SFN: X1G005401xxxx00 (The last 2 digits code (00) define Quantity. 1 000 pcs/Reel)

(1-2) Product Name / Model Name (Standard form)

T G 5 0 3 2 C F N 10.000000 M H Z C A G N D A

①            ②                            ③                            ④ ⑤ ⑥ ⑦ ⑧ ⑨

① Model

② Output

③ Frequency

④ Supply voltage

⑤ Frequency / temperature

⑥ Operation temperature

⑦ OE function (H: Non)

⑧ Vc function (Non Filter)

⑨ Internal identification code ("A" is default)

② Output	⑤ Frequency / temperature	⑧ Vc function Filter option
C CMOS	A $\pm 0.1 \times 10^{-6}$	N Non Vc
S Clipped sine Wave	B $\pm 0.28 \times 10^{-6}$	E Vc = 1.65 V Non Filter
		D Vc = 1.5 V
④ Supply voltage	⑥ Operation temperature	
C 3.3 V	G -40 °C to +85 °C	
	⑦ OE function	
	N Non OE function	

## 2. Electrical characteristics

### 1) Absolute maximum ratings

Parameter	Symbol	Unit	Min.	Typ.	Max	Notes
Supply voltage	V <sub>CC-GND</sub>	V	-0.5	-	+4.0	
Storage temperature	T <sub>stg</sub>	°C	-40	-	+90	Store as bare product after packing
Frequency control voltage	V <sub>C-GND</sub>	V	-0.5	-	V <sub>CC</sub> +0.5	V <sub>C</sub> Terminal

### 2) Operating conditions

Parameter	Symbol	Unit	Min.	Typ.	Max	Notes
Supply voltage	V <sub>CC</sub>	V	2.375	-	3.63	Supply voltage range
			2.85	3.0	3.15	V <sub>CC</sub> = 3.0 V Type
	GND		0.0	-	0.0	
Operating temperature range	T <sub>use</sub>	°C	-40	+25	+85	Standard
Frequency control voltage	V <sub>C</sub>	V	GND	N.C.	-	V <sub>C</sub> Terminal / TCXO
			0.5	1.5	2.5	V <sub>C</sub> Terminal / VC-TCXO
			0.65	1.65	2.65	
Output load condition	Load <sub>C</sub>	pF	13.5	15	16.5	CMOS output
	Load <sub>C</sub>	pF	9	10	11	Clipped sine wave
	Load <sub>R</sub>	kΩ	9	10	11	
	C <sub>c</sub>	μF	0.01	-	-	DC-cut capacitor *1 Clipped sine wave

\*1 DC-cut capacitor is not included in this TCXO. Please attach an external DC-cut capacitor (0.01 μF Min.) to the out pin.

### 3-1) Frequency characteristics

(V<sub>CC</sub> = Typ., GND = 0.0 V, V<sub>C</sub> = Typ. V, Load = Typ., T<sub>use</sub> = +25 °C)

Parameter	Symbol	Unit	Min.	Typ.	Max	Notes
Output frequency	fo	MHz	10	-	40	Standard frequency list
			10, 12.8, 19.2, 20, 24, 576, 25, 25.6, 26, 30.72, 38.4, 38.88, 40			
Frequency tolerance *2 (T <sub>use</sub> =+25 °C ±2 °C) (Reflow cycles : 2 times)	f <sub>tol</sub>	× 10 <sup>-6</sup>	-1.0	-	+1.0	
Frequency / temperature characteristics (Reference to (f <sub>max</sub> +f <sub>min</sub> )/2.)	fo-Tc	× 10 <sup>-6</sup>	-0.10	-	+0.10	T <sub>use</sub> = -40 °C to +85 °C (Standard)
			-0.14	-	+0.14	T <sub>use</sub> = -40 °C to +85 °C
			-0.25	-	+0.25	T <sub>use</sub> = -40 °C to +85 °C
			-0.28	-	+0.28	T <sub>use</sub> = -40 °C to +85 °C
Frequency / load coefficient	fo-Load	× 10 <sup>-6</sup>	-0.10	-	+0.10	Load ±10 %
			-0.05	-	+0.05	Load ±2 %
Frequency / voltage coefficient	fo- V <sub>CC</sub>	× 10 <sup>-6</sup>	-0.10	-	+0.10	V <sub>CC</sub> ±5 %
			-0.05	-	+0.05	V <sub>CC</sub> ±2 %
Frequency slope	-	× 10 <sup>-6</sup> / °C	-0.10	-	+0.10	Minimum of 1 frequency reading every 2 °C, over the operating temperature range (1 °C/minute max.)
Hysteresis	-	× 10 <sup>-6</sup>	-0.20	-	+0.20	Frequency measured before and after at +25 °C.
Frequency aging *6	f <sub>age</sub>	× 10 <sup>-6</sup>	-0.5	-	+0.5	T <sub>use</sub> = +25 °C, First year
			-3.0	-	+3.0	T <sub>use</sub> = +25 °C, 20 years
Holdover stability (Constant temperature)	-	× 10 <sup>-6</sup>	-0.01	-	+0.01	T <sub>use</sub> = +25 °C, 1 day *3
			-0.04	-	+0.04	T <sub>use</sub> = +25 °C, 1 day *4
Holdover stability (Free-run accuracy)	-	× 10 <sup>-6</sup>	-4.6	-	+4.6	*5
Acceleration sensitivity	-	× 10 <sup>-9</sup> / G	-	2.0	-	3 axes, 30-1500 Hz

\*2 Measured 24 hours after reflow soldering.

\*3 After 10 days of continuous operation.

\*4 After 48 hours of continuous operation.

\*5 This includes initial frequency tolerance, frequency / temperature characteristics, frequency / load coefficient, frequency/voltage coefficient and frequency aging (+25 °C, 20 years)

\*6 Aging stability is estimated from environmental reliability tests and the expected amount of the frequency variation over time. It is not intend as a guarantee of performance over the product-life cycle

**3-2) Frequency control characteristics** ( $V_{CC} = \text{Typ.}$ ,  $GND = 0.0 \text{ V}$ ,  $V_C = \text{Typ. V}$ ,  $\text{Load} = \text{Typ.}$ ,  $T_{\text{use}} = +25 \text{ }^\circ\text{C}$ )

Parameter	Symbol	Unit	Min.	Typ.	Max	Notes
Frequency control range	f_cont	$\times 10^{-6}$	-10.0 +5.0	-	-5.0 +10.0	$V_C = 1.5 \text{ V} \pm 1.0 \text{ V}$ , $V_C = 1.65 \text{ V} \pm 1.0 \text{ V}$
Linearity	-	%	-10	-	+10	
Input impedance	Z <sub>IN</sub>	k $\Omega$	100	-	-	$V_C$ -GND(DC), $V_C = \text{Typ.}$
Frequency change polarity	-	-	Positive polarity			

**4) Electrical Characteristics** ( $V_{CC} = \text{Typ.}$ ,  $GND = 0.0 \text{ V}$ ,  $V_C = \text{Typ. V}$ ,  $\text{Load} = \text{Typ.}$ ,  $T_{\text{use}} = +25 \text{ }^\circ\text{C}$ )

Parameter	Symbol	Unit	Min.	Typ.	Max	Notes
Current consumption	I <sub>CC</sub>	mA	-	-	5.0	Clipped sine wave (Standard)
			-	-	3.0	Clipped sine wave (Option)
			-	-	5.0	CMOS (~26 MHz)
			-	-	6.0	CMOS (~40 MHz)
Start up time	t <sub>str</sub>	ms	-	1.0	5.0	t=0 at 90 %V <sub>CC</sub>
Rise time	t <sub>r</sub>	ns	-	-	8.0	10 %V <sub>CC</sub> to 90 %V <sub>CC</sub> level CMOS output
Fall time	t <sub>f</sub>	ns	-	-	8.0	90 %V <sub>CC</sub> to 10 %V <sub>CC</sub> level CMOS output
Symmetry	SYM	%	45	50	55	50 % V <sub>CC</sub> level CMOS output
			40	50	60	GND level (DC-cut) Clipped sine wave (Option)
High output voltage	V <sub>OH</sub>	V	90 % V <sub>CC</sub>	-	-	CMOS output
Low output voltage	V <sub>OL</sub>	V	-	-	10 % V <sub>CC</sub>	CMOS output
Output level	V <sub>pp</sub>	V	0.8	-	-	Clipped sine wave
Phase Noise 10 MHz TCXO mode	L(f)	dBc/Hz	-	-69	-	1 Hz offset
			-	-98	-	10 Hz offset
			-	-125	-	100 Hz offset
			-	-144	-	1 kHz offset
			-	-152	-	10 kHz offset
			-	-153	-	100 kHz offset
			-	-154	-	1 MHz offset
Phase Noise 19.2 MHz TCXO mode ( ) is VC-TCXO mode	L(f)	dBc/Hz	-	-63 (-60)	-	1 Hz offset
			-	-92 (-90)	-	10 Hz offset
			-	-119 (-116)	-	100 Hz offset
			-	-140 (-139)	-	1 kHz offset
			-	-153 (-152)	-	10 kHz offset
			-	-154 (-154)	-	100 kHz offset
			-	-155 (-154)	-	1 MHz offset
Phase Noise 20 MHz TCXO mode ( ) is VC-TCXO mode	L(f)	dBc/Hz	-	-62 (-62)	-	1 Hz offset
			-	-92 (-90)	-	10 Hz offset
			-	-119 (-117)	-	100 Hz offset
			-	-140 (-138)	-	1 kHz offset
			-	-152 (-152)	-	10 kHz offset
			-	-154 (-154)	-	100 kHz offset
			-	-154 (-155)	-	1 MHz offset
Phase Noise 25 MHz TCXO mode ( ) is VC-TCXO mode	L(f)	dBc/Hz	-	-62 (-60)	-	1 Hz offset
			-	-93 (-90)	-	10 Hz offset
			-	-118 (-116)	-	100 Hz offset
			-	-139 (-137)	-	1 kHz offset
			-	-153 (-152)	-	10 kHz offset
			-	-154 (-154)	-	100 kHz offset
			-	-156 (-156)	-	1 MHz offset
Phase Noise 40 MHz TCXO mode ( ) is VC-TCXO mode	L(f)	dBc/Hz	-	-59 (-54)	-	1 Hz offset
			-	-89 (-83)	-	10 Hz offset
			-	-114 (-110)	-	100 Hz offset
			-	-135 (-132)	-	1 kHz offset
			-	-150 (-149)	-	10 kHz offset
			-	-152 (-152)	-	100 kHz offset
			-	-155 (-155)	-	1 MHz offset

### 3. Characteristics

#### 3-1) "Frequency / Temperature Characteristics"

3-1-1) Standard spec :  $\pm 0.1 \times 10^{-6}$  Max. ( $T_{\text{use}} = -40 \text{ }^{\circ}\text{C}$  to  $+85 \text{ }^{\circ}\text{C}$ )

19.2 MHz [N = 40 pcs]

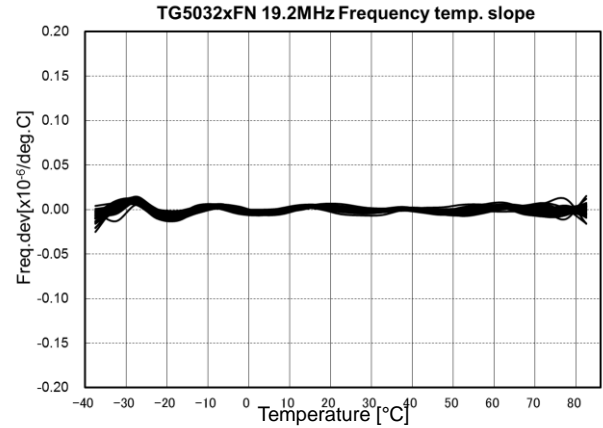
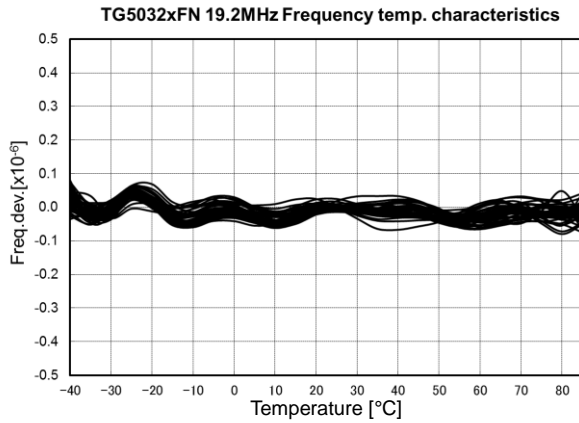

30.72 MHz [N = 40 pcs]

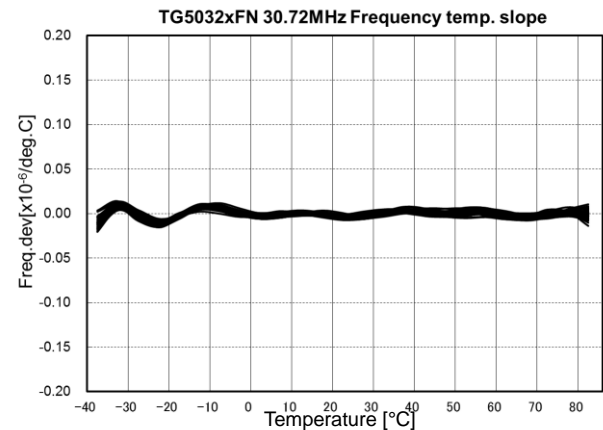
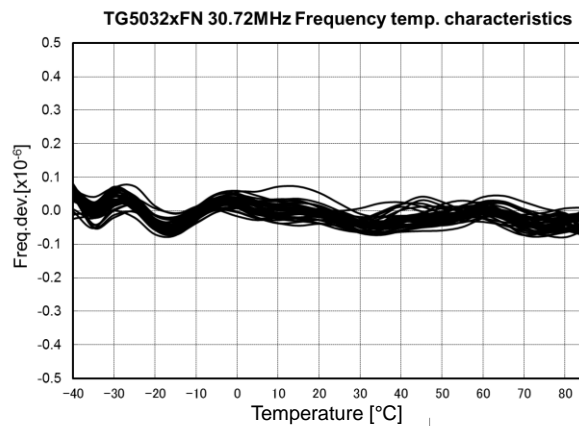

40 MHz [N = 40 pcs]

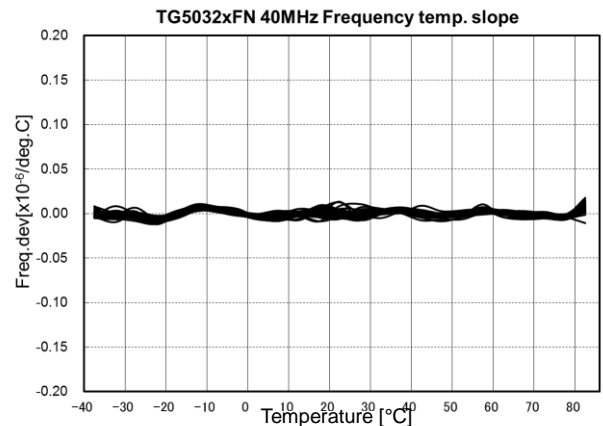
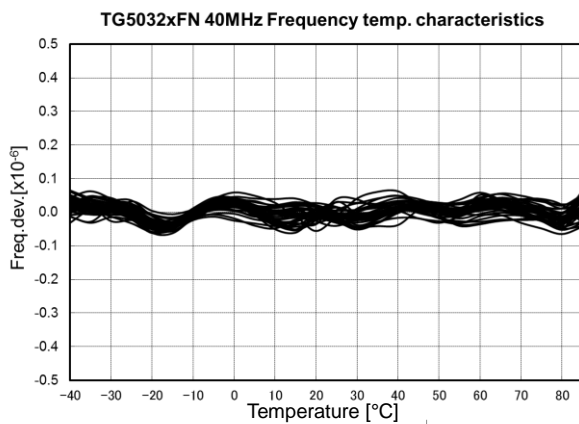

### 3-2) Frequency Aging (40 MHz) [N = 5 pcs]

\* Aging is estimated from environmental reliability tests and the expected amount of frequency variation over time. It is not intended as a guarantee of performance over the product-life cycle.

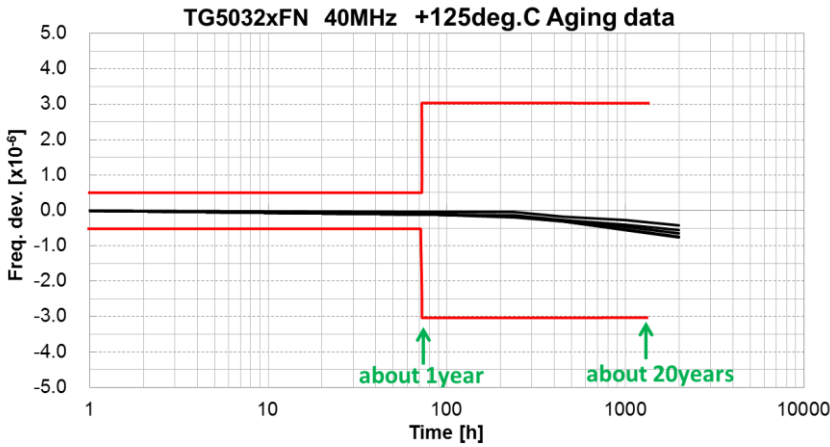

about 1year  
 Ave. :  $-0.10 \times 10^{-6}$   
 Max. :  $-0.05 \times 10^{-6}$   
 Min. :  $-0.12 \times 10^{-6}$

about 20years  
 Ave. :  $-0.54 \times 10^{-6}$   
 Max. :  $-0.35 \times 10^{-6}$   
 Min. :  $-0.66 \times 10^{-6}$

### 3-3) Holdover Stability (19.2 MHz) [N = 40 pcs]

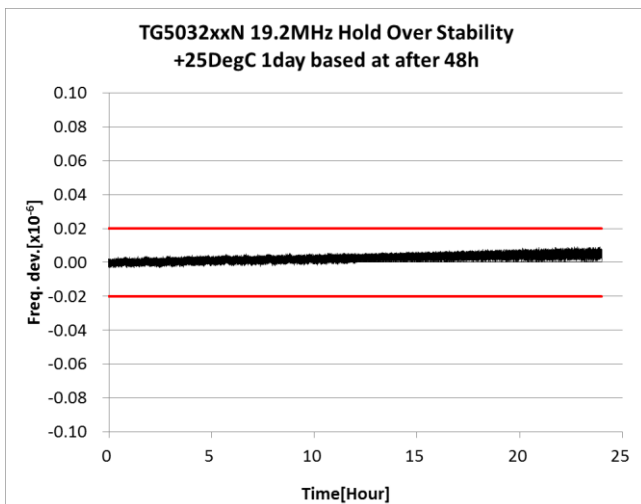

### 3-4) Frequency Control Characteristics [N = 40 pcs]

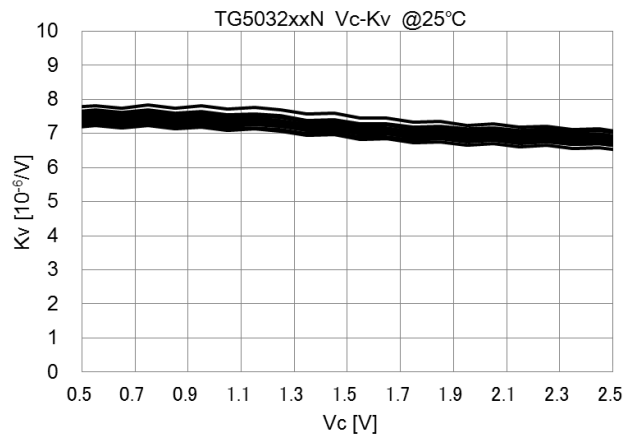
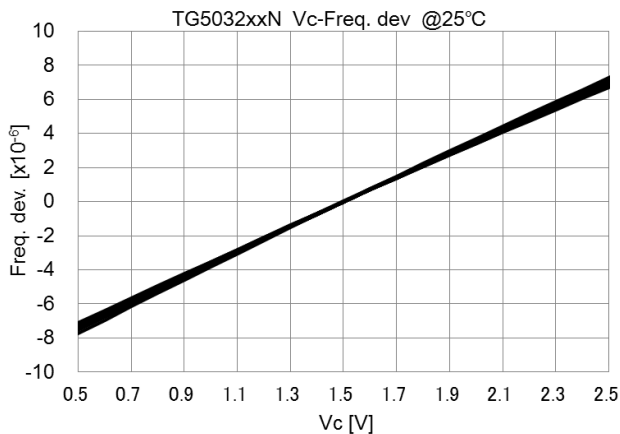

### 3-5) Current Consumption

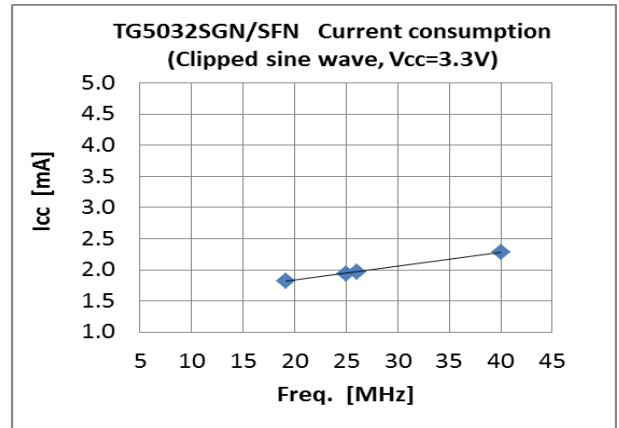
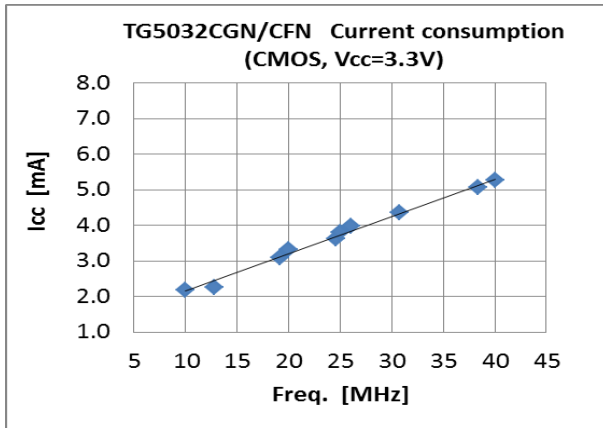

### 3-6) Rise time / Fall time (at CMOS output)

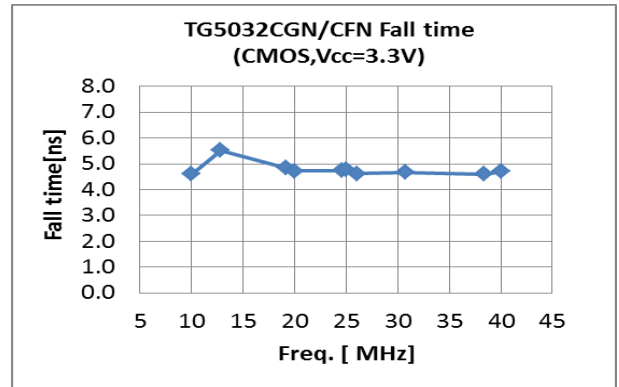
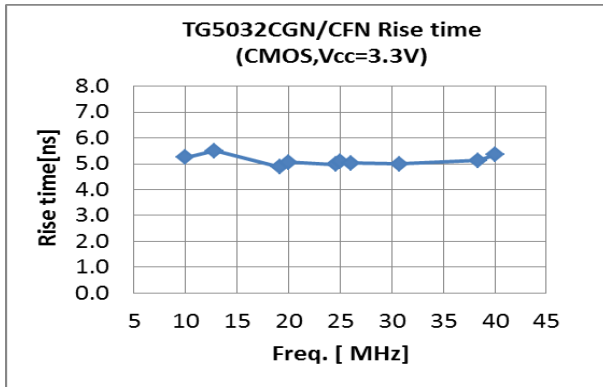

### 3-7) Output voltage [V<sub>OH</sub>, V<sub>OL</sub>] (at CMOS output)

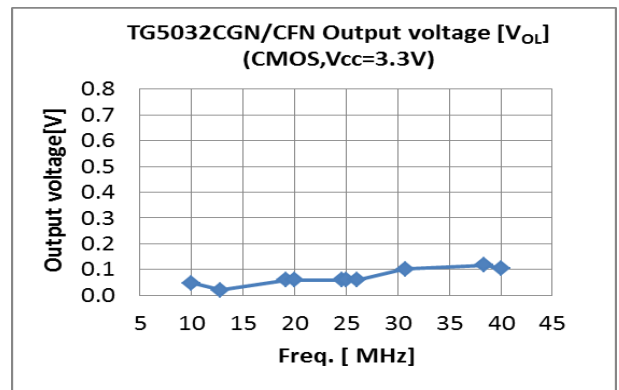
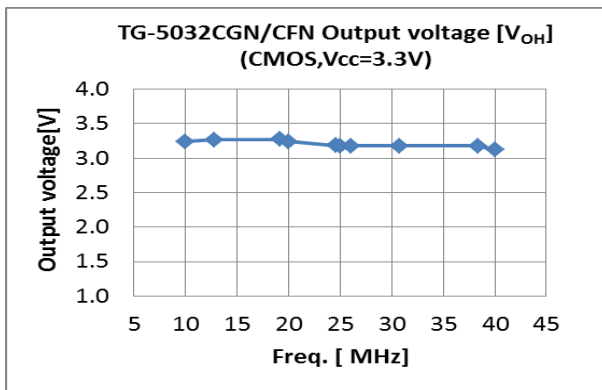

### 3-8) Symmetry (at CMOS output)

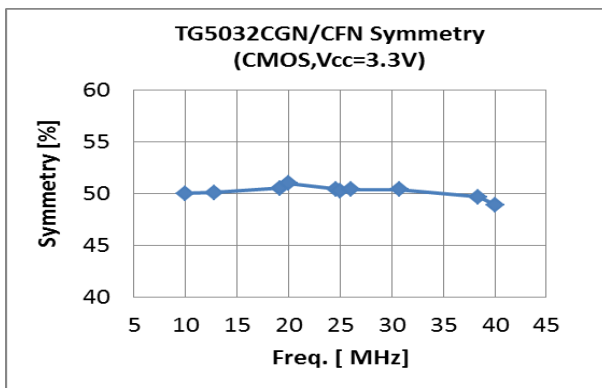

### 2-9) Output level [V<sub>PP</sub>] (at Clipped sine wave)

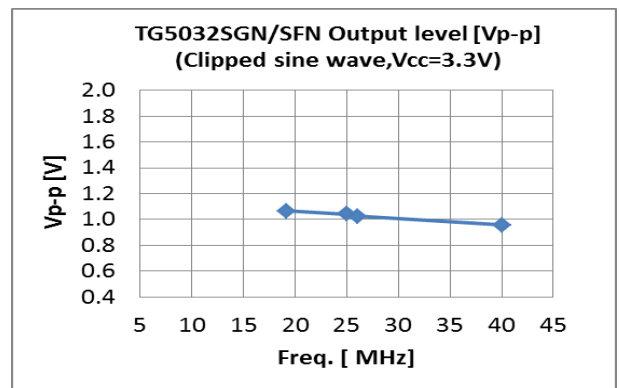



3-10) Start up time (19.2 MHz, 40 MHz)

19.2 MHz

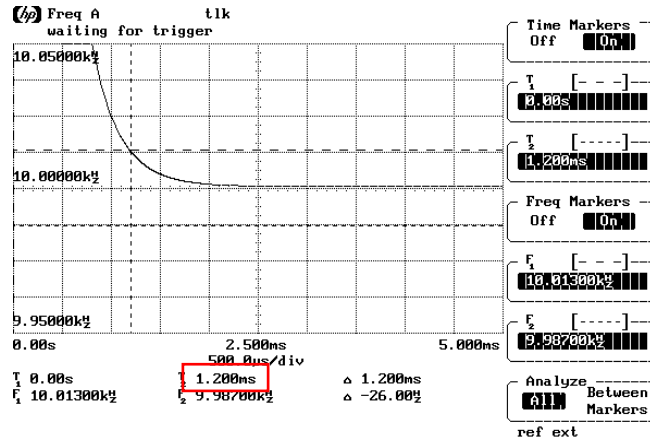

40 MHz

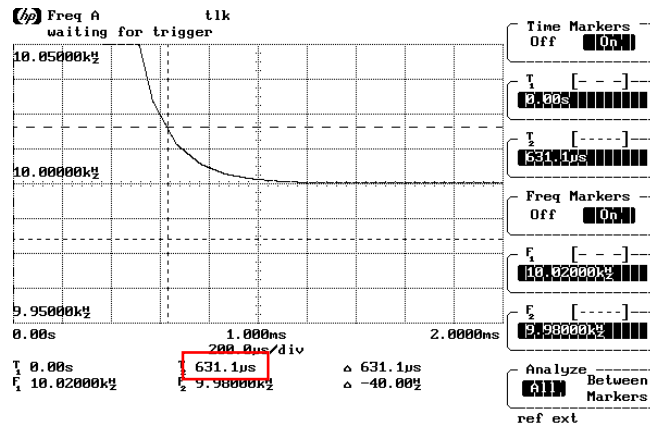

3-11) Phase noise (10 MHz, 19.2 MHz, 20 MHz) [N = 25 pcs]

10 MHz

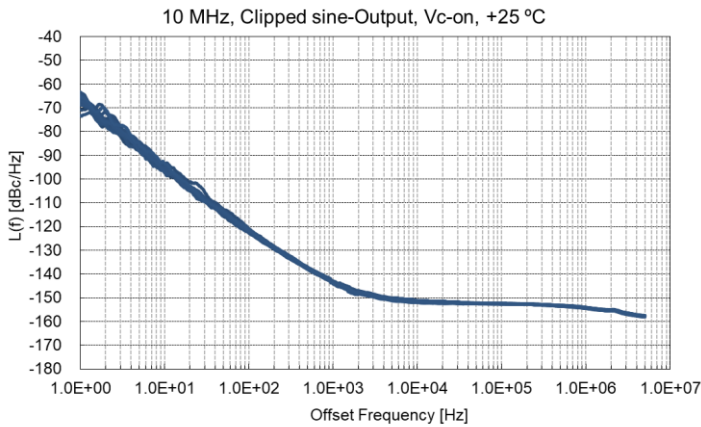

19.2 MHz

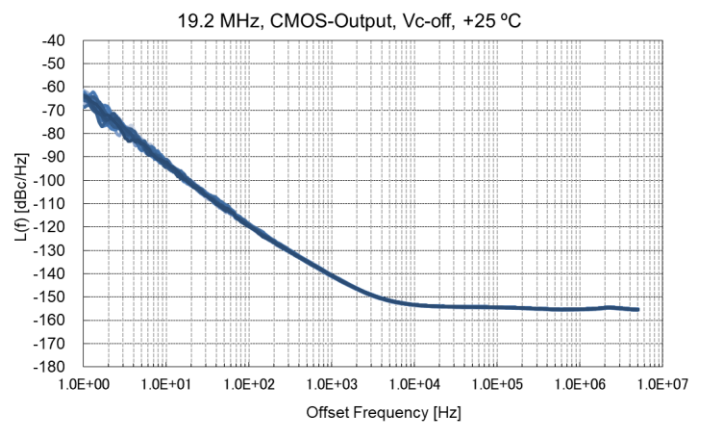
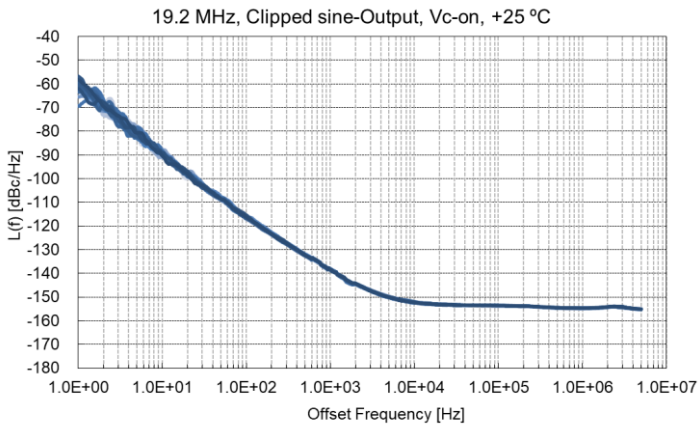

20 MHz

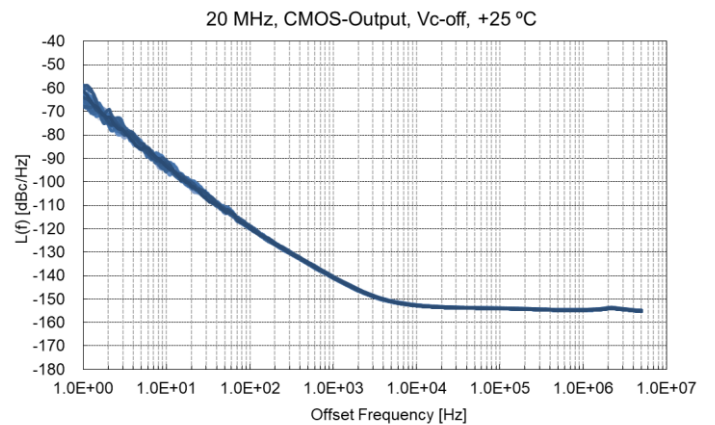
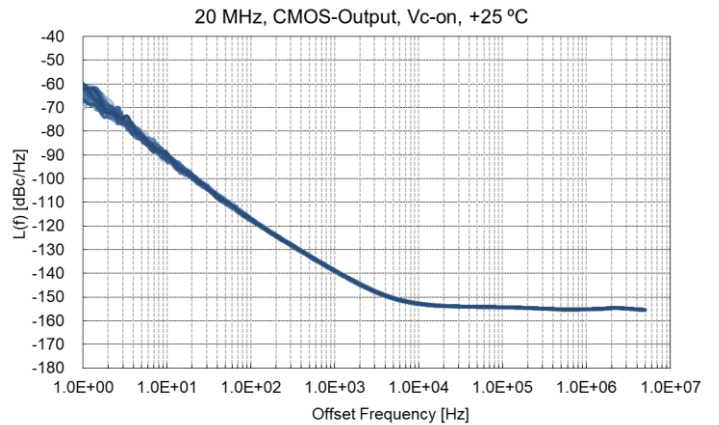
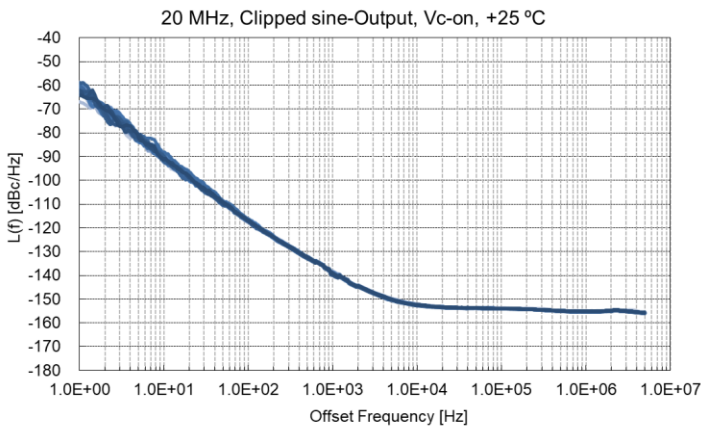

**3-11) Phase noise (25 MHz, 30.72 MHz, 40 MHz) [n = 25 pcs]**

25 MHz

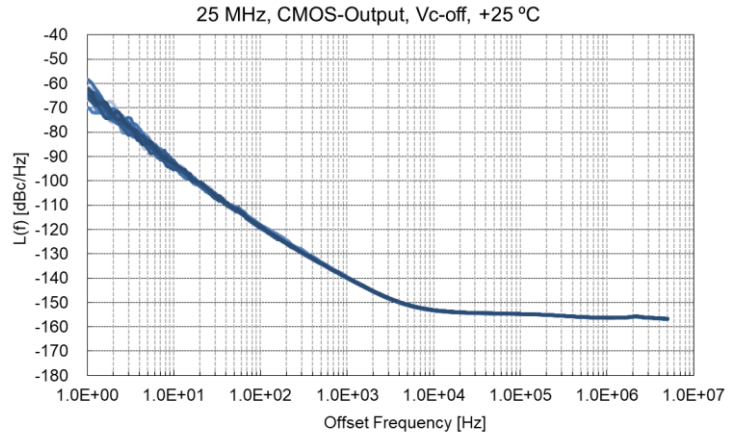
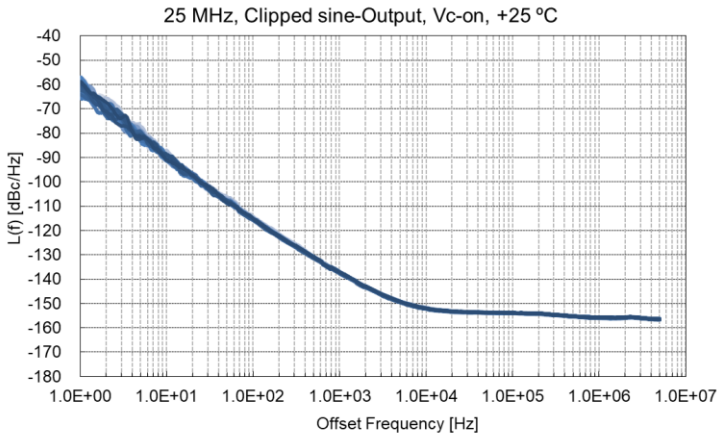

30.72 MHz

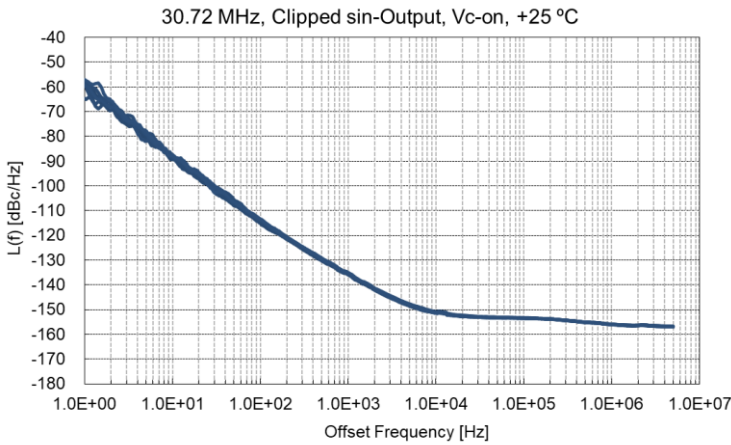

40 MHz

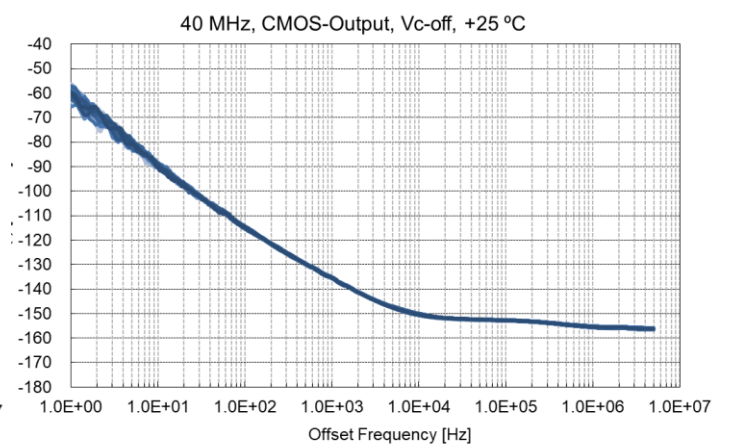
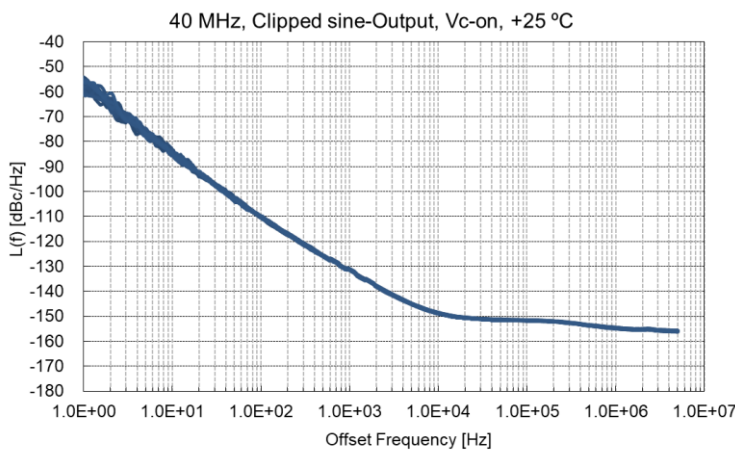

### 3-12) Short term stability [ADEV] (19.2 MHz) TCXO mode

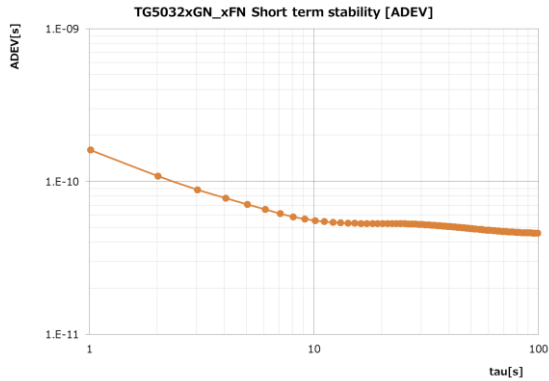

### 3-13) TDEV (19.2 MHz, Loop BW = 0.1 Hz) Constant temperature : +25 °C

Symmetricon TimeMonitor Analyzer (file=00190.asc)  
TDEV: Freq=2.048 MHz; F=13.29 Hz; \*2015/04/24 08:18:40\*  
HP 53132A; Test: 190; TG5032CAN\_19.2M; div10 fast; 0.1Hz; Samples: 1600000; Fast Sampling; Stop: 1600000; Total Points: 3342613; Ref ch2: 2.048 MHz; T1/T1

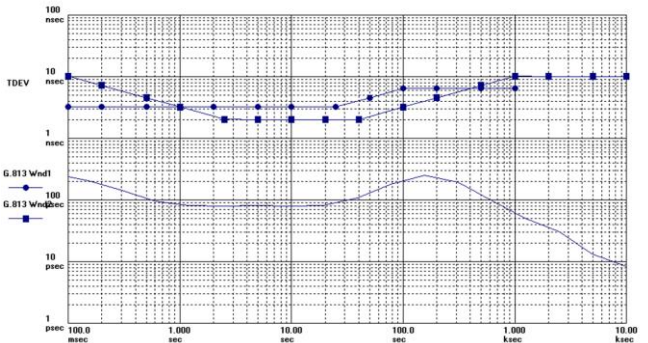

### Constant temperature : +70 °C

Symmetricon TimeMonitor Analyzer (file=00236.asc)  
TDEV: Freq=2.048 MHz; F=13.75 Hz; \*2015/05/08 07:58:09\*  
HP 53132A; Test: 236; TG5032CAN\_19.2M; div10 fast; 0.1Hz; Samples: 1600000; Fast Sampling; Stop: 1600000; Total Points: 3629868; Ref ch2: 2.048 MHz; T1/T1

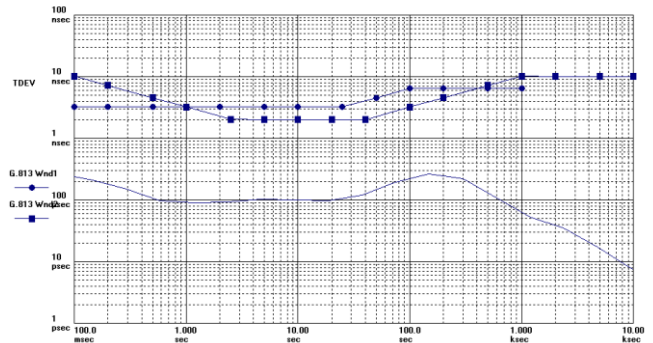

### 3-14) MTIE (19.2 MHz, Loop BW = 0.1 Hz) Constant temperature : +25 °C

Symmetricon TimeMonitor Analyzer (file=00190.asc)  
MTIE: Freq=2.048 MHz; F=13.29 Hz; \*2015/04/24 08:18:40\*  
HP 53132A; Test: 190; TG5032CAN\_19.2M; div10 fast; 0.1Hz; Samples: 1600000; Fast Sampling; Stop: 1600000; Total Points: 3342613; Ref ch2: 2.048 MHz; T1/T1

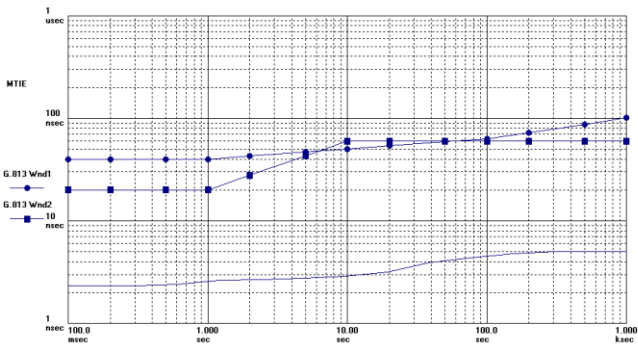

### Constant temperature : +70 °C

Symmetricon TimeMonitor Analyzer (file=00236.asc)  
MTIE: Freq=2.048 MHz; F=13.75 Hz; \*2015/05/08 07:58:09\*  
HP 53132A; Test: 236; TG5032CAN\_19.2M; div10 fast; 0.1Hz; Samples: 1600000; Fast Sampling; Stop: 1600000; Total Points: 3629868; Ref ch2: 2.048 MHz; T1/T1

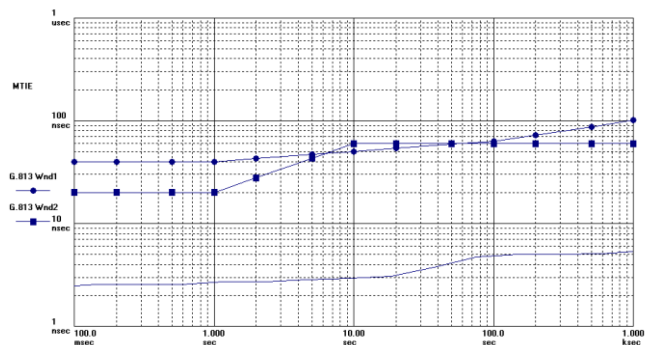

Compliant with G.813 option1 and 2

4. Outline

4-1) Outline dimensions and Pin information

TG5032CFN / SFN

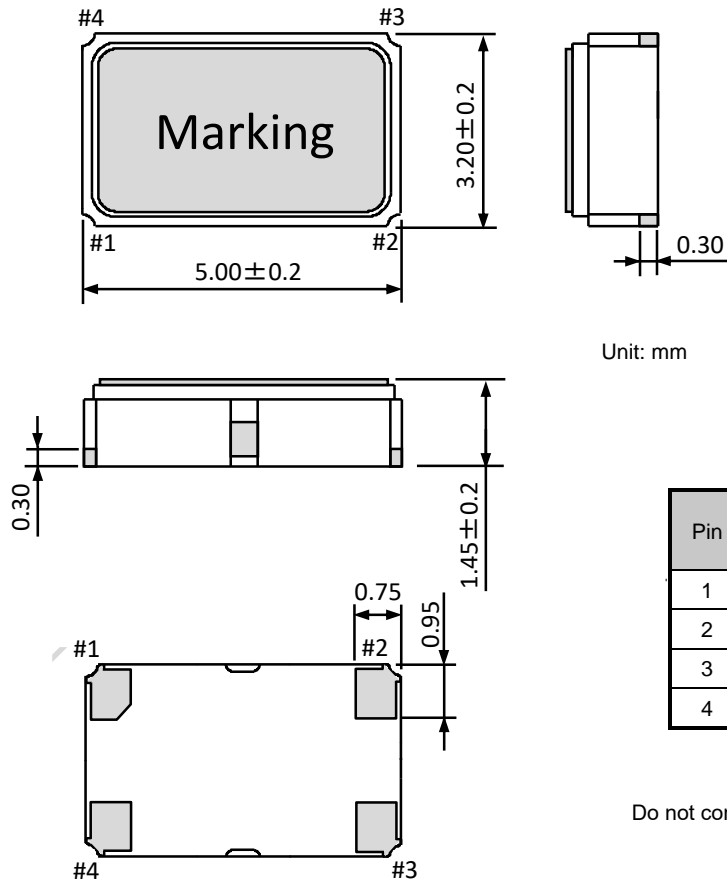

Unit: mm

Do not connect "N.C." pin with any other pins (also mutually)

4-2) Soldering pattern

Example of patterning design indicated as follows. In an actual design, please consider mounting density, the reliability of soldering, etc. and check whether performance is optimal.

Soldering pattern of TG5032CFN / SFN

unit : mm

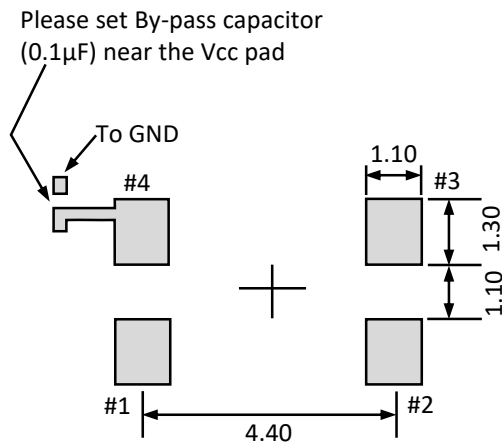

To maintain stable operation, provide a 0.1µF by-pass capacitor at a location as near as possible to the power source terminal of the crystal product (between V<sub>CC</sub> - GND).

## 5. Timing chart

### 5-1) Output waveform (CMOS output)

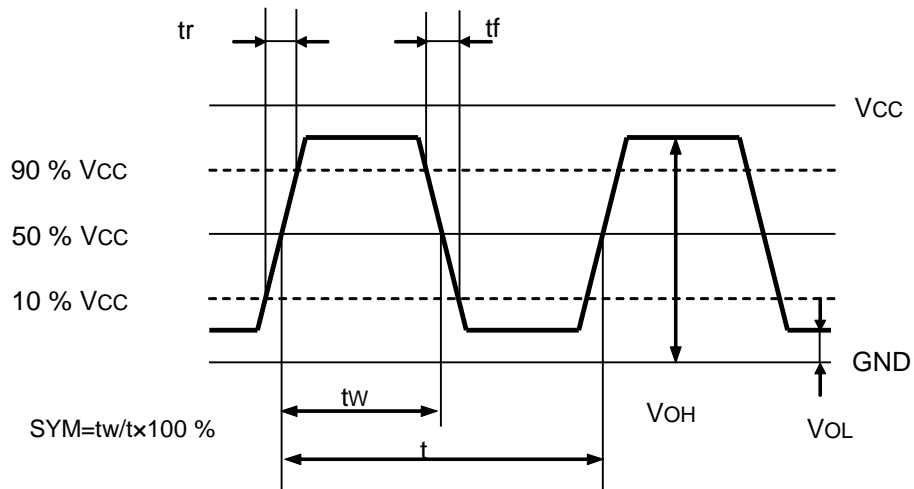

### 5-2) Output waveform (Clipped sine wave output)

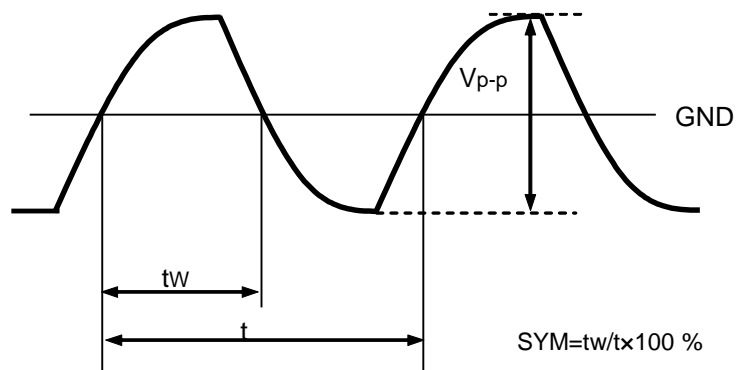





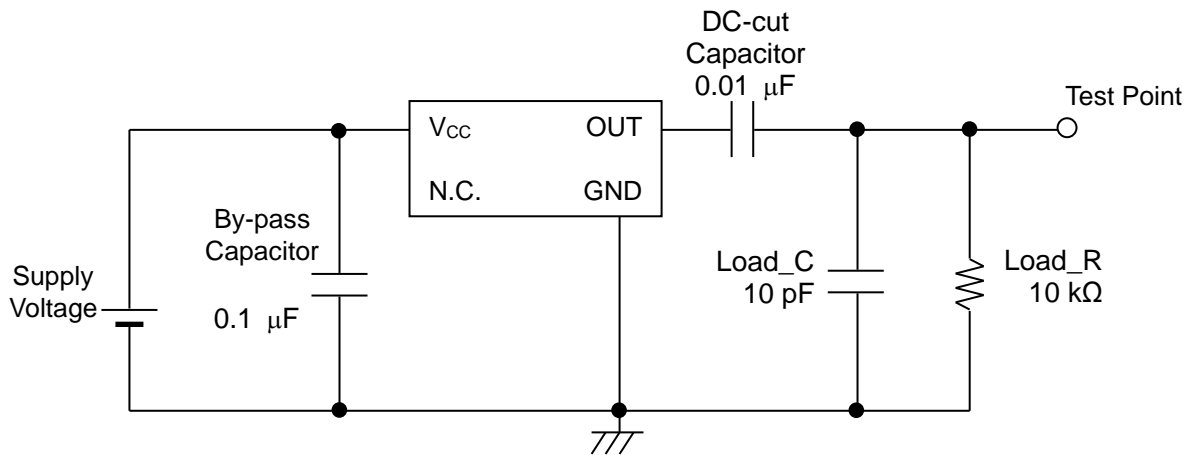

1) Output Load : 10 k $\Omega$  // 10 pF

## 2) Current consumption

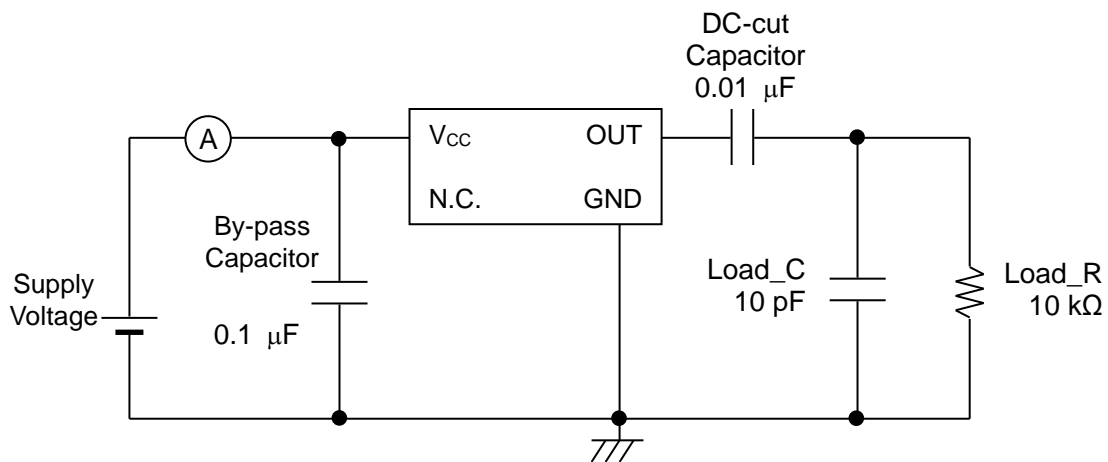

## 3) Conditions

1. Oscilloscope: Impedance Min. 1 M $\Omega$   
Input capacitance Max. 10 pF  
Band width Min. 300 MHz
2. Load\_C includes probe capacitance.
3. A capacitor (By-pass: 0.1  $\mu$ F) is placed between V<sub>CC</sub> and GND, and closely to TCXO.
4. Use the current meter whose internal impedance value is small.
5. Power Supply  
Impedance of power supply should be as low as possible.
6. GND pin should be connected to low impedance GND.

## 6-4) Clipped sine wave output for VC-TCXO

1) Output Load : 10 kΩ // 10 pF

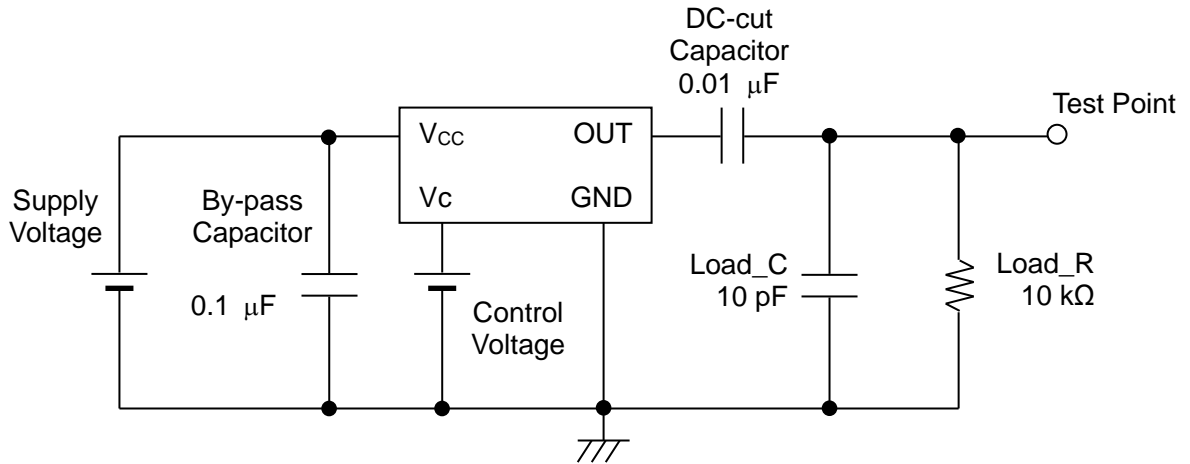

2) Current consumption

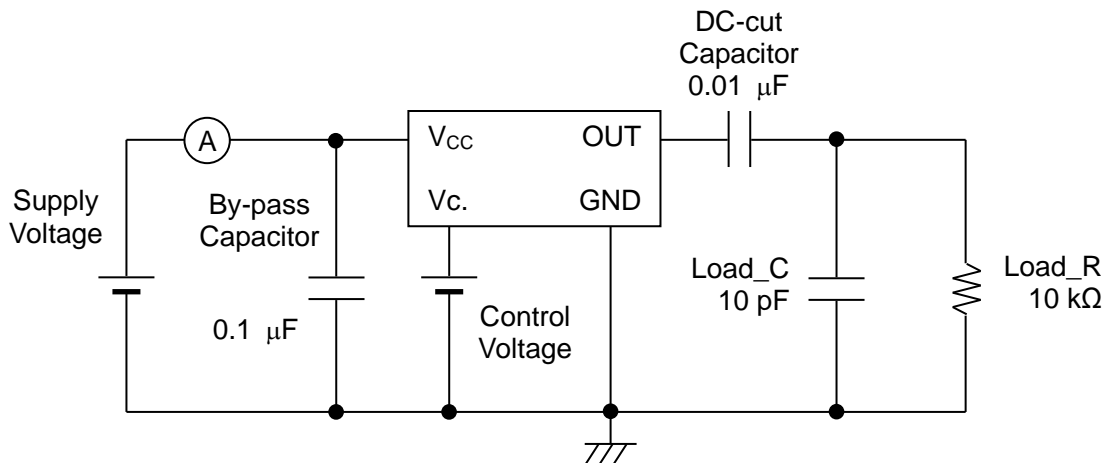

3) Conditions

1. Oscilloscope: Impedance                   Min. 1 MΩ  
                   Input capacitance           Max. 10 pF  
                   Band width                   Min. 300 MHz
2. Load\_C includes probe capacitance.
3. A capacitor (By-pass: 0.1 μF) is placed between V<sub>CC</sub> and GND, and closely to TCXO.
4. Use the current meter whose internal impedance value is small.
5. Power Supply  
     Impedance of power supply should be as low as possible.
6. GND pin should be connected to low impedance GND.

**7. Reflow profile** (follow to IPC / JEDEC J-STD-020D.1)

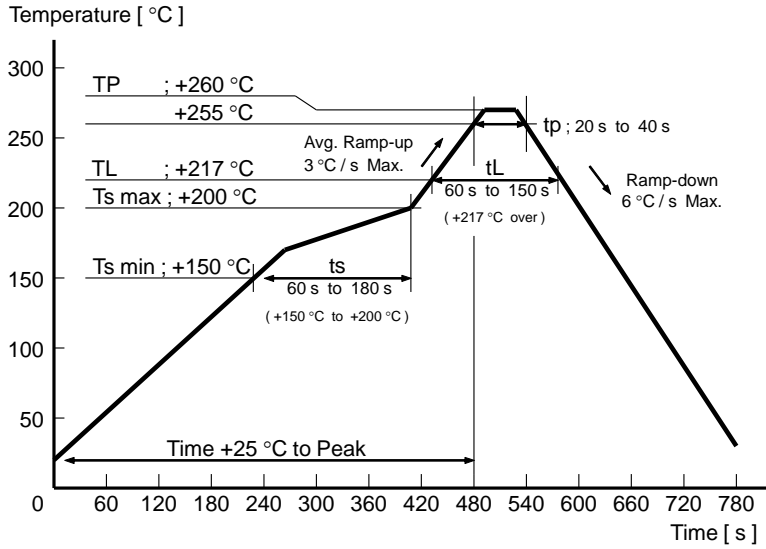

**8. Packing information**

(8-1) Product number last 2 digits code (00) define Quantity. 1 000 pcs/Reel.

TG5032CFN: X1G005391xxxx00 (Please contact Epson for details of number xxxx)

TG5032SFN: X1G005401xxxx00

(8-2) Taping specification Subject to EIA-481 IEC-60286 JIS C0806

(1) Tape dimensions

Material of the Carrier Tape: PS conduct / Material of the Top Tape: PET

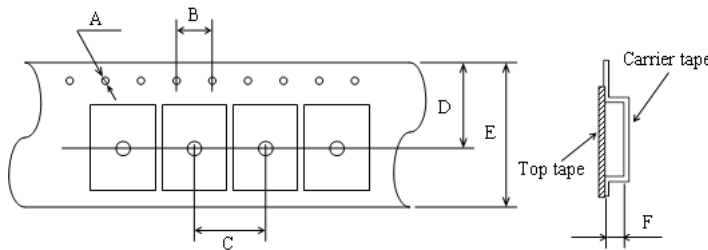

Symbol	A	B	C	D	E	F
Value	φ1.5	4.0	8.0	7.25	12.0	1.7

Unit : mm

(2) Reel dimensions

Material of the reel: Conductive polystyrene

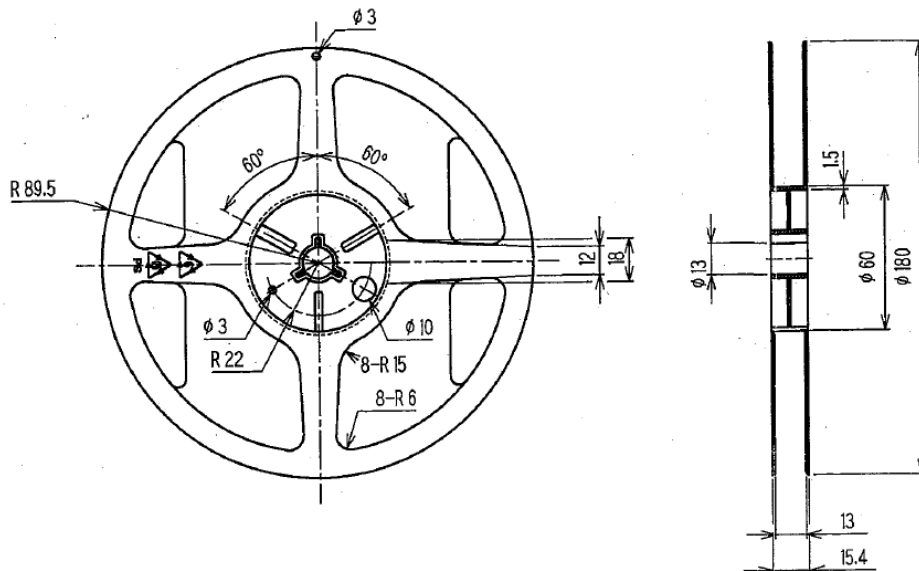

**9. Moisture Sensitivity Level, Electro-Static Discharge**

## (9-1) Moisture Sensitivity Level (MSL)

Parameter	Specifications	Conditions
MSL	LEVEL1	JEDEC J-STD-020D

## (9-2) Electro-Static Discharge (ESD)

Parameter	Specifications	Conditions
Human Body Model (HBM)	2 000 V Min	EIAJ ED-4701-1 C111A, 100 pF, 1.5 k $\Omega$ , 3 times
Machine Model (MM)	200 V Min	EIAJ ED-4701-1 C111, 200 pF, 0 $\Omega$ , 1 time

## 10. Handling precautions

Prior to using this product, please carefully read the section entitled "Precautions" on our Web site (<https://www5.epsondevice.com/en/information/#precaution>) for instructions on how to handle and use the product properly to ensure optimal performance of the product in your equipment. Before using the product under any conditions other than those specified therein, please consult with us to verify and confirm that the performance of the product will not be negatively affected by use under such conditions.

In addition to the foregoing precautions, in order to avoid the deteriorating performance of the product, we strongly recommend that you DO NOT use the product under ANY of the following conditions:

- (1) Do not expose this product to excessive mechanical shock or vibration.
- (2) This product can be damaged by mechanical shock during the soldering process depending on the equipment used, process conditions, and any impact forces experienced. Always follow appropriate procedures, particularly when changing the assembly process in anyway and be sure to follow applicable process qualification standards before starting production.
- (3) These devices are sensitive to ESD, please use appropriate precautions during handling, assembly, test, shipment, and installation.
- (4) This product contains semiconductor content that should not be exposed to electromagnetic waves.
- (5) The use of ultrasonic technology for cleaning, bonding, etc. can damage the Xtal unit inside this product. Please carefully check for this consideration before using ultrasonic equipment for volume production with this product.
- (6) Noise and ripple on the power supply may have undesirable affects on operation and cause degradation of phase noise characteristics. Evaluate the operation of this device with appropriate power supplies carefully before use.
- (7) When applying power, ensure that the supply voltage increases monotonically for proper operation. On power down, do not reapply power until the supplies, bypass capacitors, and any bulk capacitors are completely discharged since that may cause the unit to malfunction.
- (8) Aging specifications are estimated from environmental reliability tests and expected frequency variation over time. They do not provide a guarantee of aging over the product lifecycle.
- (9) The metal cap on top of the device is directly connected to the GND terminal (pin #2). Take necessary precautions to prevent any conductor not at ground potential from contacting the cap as that could cause a short circuit to GND.
- (10) Do not route any signal lines, supply voltage lines, or GND lines underneath the area where the oscillators are mounted including any internal layers and on the opposite side of the PCB. To avoid any issues due to interference of other signal lines, please take care not to place signal lines near the product as this may have an adverse affect on the performance of the product.
- (11) A bypass capacitor of the recommended value(s) must be connected between the  $V_{CC}$  and GND terminals of the product. Whenever possible, mount the capacitor(s) on the same side of the PCB and as close to the product as possible to keep the routing traces short.
- (12) Power supply connections to  $V_{CC}$  and GND pins should be routed as thick as possible while keeping the high frequency impedance low in order to get the best performance.
- (13) The use of a filter or similar element in series with the power supply connections to protect from electromagnetic radiation noise may increase the high frequency impedance of the power supply line and may cause the oscillator to not operate properly. Please verify the design to ensure sufficient operational margin prior to use.
- (14) Keep PCB routing from the output terminal(s) to the load as short as possible for best performance.
- (15) Do not short the output to GND as that will damage the product. Always use with an appropriate load resistor connected.
- (16) Product failures during the warranty period only apply when the product is used according to the recommended operating conditions described in the specifications. Products that have been opened for analysis or damaged will not be covered. It is recommended to store and use in normal temperature and humidity environments described in the specifications to ensure frequency accuracy and prevent moisture condensation. If the product is stored for more than one year, please confirm the pin solderability prior to use.
- (17) If the oscillation circuit is exposed to condensation, the frequency may change or oscillation may stop. Do not use in any conditions where condensation occurs.
- (18) Do not store or use the product in an environment where it can be exposed to chemical substances that are corrosive to metal or plastics such as salt water, organic solvents, chemical gasses, etc. Do not use the product when it is exposed to sunlight, dust, corrosive gasses, or other materials for long periods of time.
- (19) When using water-soluble solder flux make sure to completely remove the flux residue after soldering. Pay particular attention when the residues contain active halogens which will negatively affect the product and its performance.

## PROMOTION OF ENVIRONMENTAL MANAGEMENT SYSTEM CONFORMING TO INTERNATIONAL STANDARDS

At Seiko Epson, all environmental initiatives operate under the Plan-Do-Check-Action (PDCA) cycle designed to achieve continuous improvements. The environmental management system (EMS) operates under the ISO 14001 environmental management standard.

All of our major manufacturing and non-manufacturing sites, in Japan and overseas, completed the acquisition of ISO 14001 certification.





ISO 14000 is an international standard for environmental management that was established by the International Standards Organization in 1996 against the background of growing concern regarding global warming, destruction of the ozone layer, and global deforestation.

## WORKING FOR HIGH QUALITY

In order provide high quality and reliable products and services than meet customer needs, Seiko Epson made early efforts towards obtaining ISO9000 series certification and has acquired ISO9001 for all business establishments in Japan and abroad. We have also acquired IATF 16949 certification that is requested strongly by major automotive manufacturers as standard.

IATF 16949 is the international standard that added the sector-specific supplemental requirements for automotive industry based on ISO9001.

### ► Explanation of the mark that are using it for the catalog

	► Pb free.
	► Complies with EU RoHS directive. *About the products without the Pb-free mark. Contains Pb in products exempted by EU RoHS directive. (Contains Pb in sealing glass, high melting temperature type solder or other.)
	► Designed for automotive applications such as Car Multimedia, Body Electronics, Remote Keyless Entry etc.
	► Designed for automotive applications related to driving safety (Engine Control Unit, Air Bag, ESC etc ).

NOTICE : PLEASE READ CAREFULLY BELOW BEFORE THE USE OF THIS DOCUMENT ©Seiko Epson Corporation 2020

- The content of this document is subject to change without notice. Before purchasing or using Epson products, please contact with sales representative of Seiko Epson Corporation ("Epson") for the latest information and be always sure to check the latest information published on Epson's official web sites and resources.
- This document may not be copied, reproduced, or used for any other purposes, in whole or in part, without Epson's prior consent.
- Information provided in this document including, but not limited to application circuits, programs and usage, is for reference purpose only. Epson makes no guarantees against any infringements or damages to any third parties' intellectual property rights or any other rights resulting from the information. This document does not grant you any licenses, any intellectual property rights or any other rights with respect to Epson products owned by Epson or any third parties.
- Using Epson products, you shall be responsible for safe design in your products; that is, your hardware, software, and/or systems shall be designed enough to prevent any critical harm or damages to life, health or property, even if any malfunction or failure might be caused by Epson products. In designing your products with Epson products, please be sure to check and comply with the latest information regarding Epson products (including, but not limited to this document, specifications, data sheets, manuals, and Epson's web site). Using technical contents such as product data, graphic and chart, and technical information, including programs, algorithms and application circuit examples under this document, you shall evaluate your products thoroughly both in stand-alone basis and within your overall systems. You shall be solely responsible for deciding whether to adopt/use Epson products with your products.
- Epson has prepared this document carefully to be accurate and dependable, but Epson does not guarantee that the information is always accurate and complete. Epson assumes no responsibility for any damages you incurred due to any misinformation in this document.
- No dismantling, analysis, reverse engineering, modification, alteration, adaptation, reproduction, etc., of Epson products is allowed.
- Epson products have been designed, developed and manufactured to be used in general electronic applications and specifically designated applications ("Anticipated Purpose"). Epson products are NOT intended for any use beyond the Anticipated Purpose that requires particular quality or extremely high reliability in order to refrain from causing any malfunction or failure leading to critical harm to life and health, serious property damage, or severe impact on society, including, but not limited to listed below ("Specific Purpose"). Therefore, you are strongly advised to use Epson products only for the Anticipated Purpose. Should you desire to purchase and use Epson products for Specific Purpose, Epson makes no warranty and disclaims with respect to Epson products, whether express or implied, including without limitation any implied warranty of merchantability or fitness for any Specific Purpose. Please be sure to contact our sales representative in advance, if you desire Epson products for Specific Purpose:  
Space equipment (artificial satellites, rockets, etc.)/ Transportation vehicles and their control equipment (automobiles, aircraft, trains, ships, etc.) / Medical equipment/ Relay equipment to be placed on sea floor/ Power station control equipment / Disaster or crime prevention equipment/Traffic control equipment/ Financial equipment  
Other applications requiring similar levels of reliability as the above
- Epson products listed in this document and our associated technologies shall not be used in any equipment or systems that laws and regulations in Japan or any other countries prohibit to manufacture, use or sell. Furthermore, Epson products and our associated technologies shall not be used for the purposes of military weapons development (e.g. mass destruction weapons), military use, or any other military applications. If exporting Epson products or our associated technologies, please be sure to comply with the Foreign Exchange and Foreign Trade Control Act in Japan, Export Administration Regulations in the U.S.A (EAR) and other export-related laws and regulations in Japan and any other countries and to follow their required procedures.
- Epson assumes no responsibility for any damages (whether direct or indirect) caused by or in relation with your non-compliance with the terms and conditions in this document or for any damages (whether direct or indirect) incurred by any third party that you give, transfer or assign Epson products.
- For more details or other concerns about this document, please contact our sales representative.
- Company names and product names listed in this document are trademarks or registered trademarks of their respective companies.

## X-ON Electronics

Largest Supplier of Electrical and Electronic Components

*Click to view similar products for [TCXO Oscillators](#) category:*

*Click to view products by [Epson](#) manufacturer:*

Other Similar products are found below :

[AST3TQ-40.000MHZ-5](#) [SIT5000ACC8E-33VQ-19.200000X](#) [SiT5001AI-2E-33N0-48.000000X](#) [TG3225CEN 25.0000M-KFGNNAB](#)  
[SIT5001AI-2E-33N0-24.000000x](#) [SIT1566AC-JV-18E-32.768E](#) [AST3TDATAACJ5-10.0000MHz](#) [AST3TDATAACJ5-20.0000MHz](#)  
[AST3TDA53TACJ2-38.8800MHz](#) [AST3TDATAACJ5-38.8800MHz](#) [NT0503CC3I287EN10](#) [NT0503CH3I287CN25](#) [NT0503CH3I287CN30.72](#)  
[NT0503CC3I287DN20](#) [TG-3541CE 32.7680KXB0](#) [KT1612A26000AAW18TBL](#) [KT1612A26000AAW18NBL](#) [TG-5006CG-12H 26.0000M0](#)  
[TG2520SMN 38.4000M-MCGNNM3](#) [X1G004131000900](#) [1XXC26000PKA](#) [X1G005441030316](#) [X1G005441020616](#) [X1G005441030416](#)  
[X1G005421020416](#) [X1G005441020316](#) [7L26002007](#) [1XTV12800MDA](#) [X1G005421031215](#) [X1G005421020516](#) [SX1T19.200B010J020S](#)  
[T132S4-25000ML33DTL](#) [X1G0053710200](#) [8153H-50.000LH33DTL](#) [NT0503EH3I106EN10](#) [NT0507BH3I107BN40](#) [NT0503CH3I207EN10](#)  
[NT0507BH3I507EA10](#) [BT0507BC3I287CN38.4B](#) [NT0507BH3I106BA50](#) [NT0503CH3I507CN24.576](#) [OW2EL89CENUXFMYLC-16M](#)  
[OW2EL89CENUXFMYLC-32M](#) [OW2EL89CENUXFMYLC-24M](#) [OW7EL89CENUYO3YLC-24M](#) [OW3EL89CENUNFAYLC-26M](#)  
[OW7EL89CENUYO3YLC-20M](#) [OW7EL89CENUNFAYLC-52M](#) [OW7EL89CENUYO3YLC-40M](#) [OW2EL89CENUXFMYLC-30M](#)