

# DC/DC regulator

Input 3.0 - 5.5 V  
Output 10 A

## Contents

Product Program . . . . .	2
Mechanical Data . . . . .	3
Connections . . . . .	3
Absolute Maximum Ratings . . . . .	4
Input . . . . .	4
Product Qualification Specification . . . . .	5
Safety Specification . . . . .	6
Adjusted to 1.0 V out - Data . . . . .	7
Adjusted to 1.2 V out - Data . . . . .	10
Adjusted to 1.5 V out - Data . . . . .	13
Adjusted to 1.8 V out - Data . . . . .	16
Adjusted to 2.5 V out - Data . . . . .	19
Adjusted to 3.3 V out - Data . . . . .	22
EMC Specification . . . . .	25
Operating Information . . . . .	25
Thermal Considerations . . . . .	28
Soldering Information . . . . .	29
Delivery Package Information . . . . .	30
Reliability . . . . .	30
Compatibility with RoHS requirements . . . . .	30
Sales Offices and Contact Information . . . . .	31

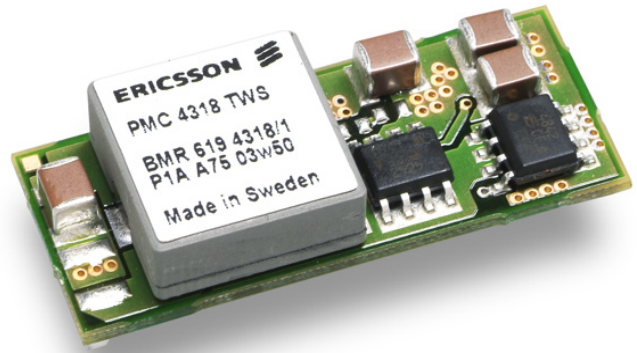

## Key Features

- Wide input, 3.0-5.5 Vdc
- Programmable output, 0.75 - 3.6 Vdc
- Under voltage protection
- Short circuit protection
- Remote sense
- Remote On/Off
- Design for Environment (DfE)
- European Commission Directive 2002/95/EC (RoHs) compliant

The PMC series of surface mount DC/DC regulators (POL) are intended to be used as local distributed power sources in distributed power architecture level 4. The high efficiency and high reliability of the PMC series makes them particularly suited for the communications equipment of today and tomorrow. These products are manufactured using the most advanced technologies and materials to comply

with environmental requirements. Designed to meet high reliability requirements of systems manufacturers, the PMC responds to world-class specifications.

Ericsson Power Modules is an ISO 9001/14001 certified supplier.

## Product Program

V <sub>I</sub>	V <sub>O</sub> /I <sub>O</sub> max	P <sub>O</sub> max	Ordering No.	Comment
	Output 1			
3.0-5.5 V*	0.75-3.3 V/10 A	33 W	PMC 4318T WS	Standard version
3.0-5.5 V	1.0 V/10 A	10 W	PMC 4118N WS	On request
3.0-5.5 V	1.2 V/10 A	12 W	PMC 4118L WS	On request
3.0-5.5 V	1.5 V/10 A	15 W	PMC 4118H WS	On request
3.0-5.5 V	1.8 V/10 A	18 W	PMC 4118G WS	On request
3.0-5.5 V	2.5 V/10 A	25 W	PMC 4219 WS	On request
3.8-5.5 V*	3.3 V/10 A	33 W	PMC 4310 WS	On request
Option		Suffix	Example	
Negative Remote Control logic		N	PMC 4318T WS N	

\* Input voltage limited to 3.8-5.5V for 3.3 Vout and for output voltages of 3.3V and 4.5-5.5 for output voltages above 3.3V.

## Ordering Information

Delivery option	M.o.q.	Suffix	Example
Tape & Reel	200 pcs	/C	PMC 4xxxT WS /C

## Mechanical Data

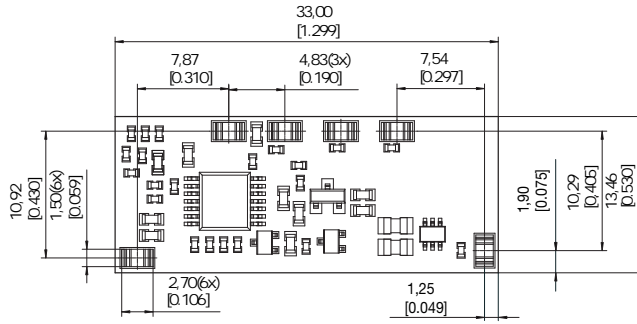

Bottom View

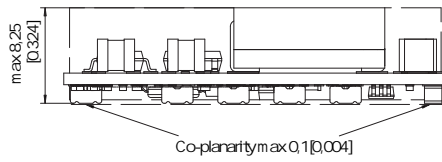

Dimensions in mm [inch]  
 Tolerances (unless specified):  
 x,xx ±0,25 [0,01]  
 Pin true position  $\pm$  0,4 [0,016]

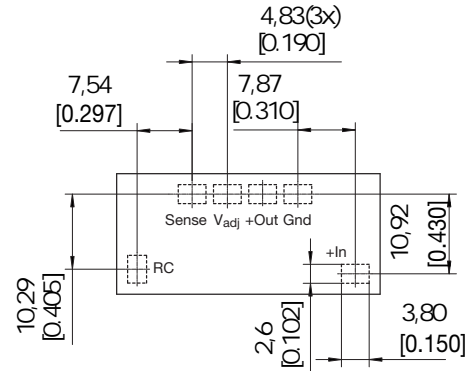
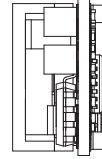

Recommended footprint.  
 Top View

## Connections

Pin	Designation	Function
1	RC	Remote Control
2	+ In	Positive input
3	Gnd	Ground
4	+ Out	Positive output
5	Vadj	External output adjust
6	+ Sense	Positive remote sense

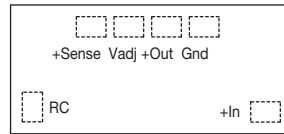

## Weight

7 g

## Pins

Material: Copper

Plating: Flash gold over nickel

## Absolute Maximum Ratings

Characteristics		min	typ	max	Unit
$T_{ref}$	Operating Reference Temperature, see pg. 27	-45		+115	°C
$T_S$	Storage temperature	-55		+125	°C
$V_I$	Input voltage	-0.3		+5.5	Vdc

Stress in excess of Absolute Maximum Ratings may cause permanent damage. Absolute Maximum Ratings, sometimes referred to as no destruction limits, are normally tested with one parameter at a time exceeding the limits of Output data or Electrical Characteristics. If exposed to stress above these limits, function and performance may degrade in an unspecified manner.

**Input**  $T_{ref} = -30 \dots +90 \text{ }^\circ\text{C}$ ,  $V_I = 3.0 \dots 5.5 \text{ V}$  unless otherwise specified  
Typ values specified at:  $T_{ref} = +25 \text{ }^\circ\text{C}$ ,  $V_{Inom}$ ,  $I_o \text{max} = 10 \text{ A}$

Characteristics		Conditions	min	typ	max	Unit
$V_I$	Input voltage range		3.0		5.5	Vdc
$V_{Ioff}$	Turn-off input voltage	Ramp from higher voltage, $V_{out}$ set to 1.0-2.5 V		2.6		Vdc
		Ramp from higher voltage, $V_{out}$ set to 3.3 V		3.5		
$V_{Ion}$	Turn-on input voltage	Ramp from lower voltage, $V_{out}$ set to 1.0-2.5 V		2.7		Vdc
		Ramp from lower voltage, $V_{out}$ set to 3.3 V		3.6		
$C_I$	Input capacitance			20		$\mu\text{F}$
$P_{ii}$	Input idling power	$I_o = 0 \text{ A}$ , $V_I = 5 \text{ V}$			570	mW
$P_{RC}$	Input stand-by power (RC active)	Non operation, $V_I = 5 \text{ V}$			7.5	mW
$V_{Iac}$	Input ripple 1)	20 Hz ... 5 MHz, $I_o \text{max}$ , $V_I = 5 \text{ V}$		300		mV

1) Measured with 2 x 22  $\mu\text{F}$  ceramic capacitors

## Fundamental Circuit Diagram

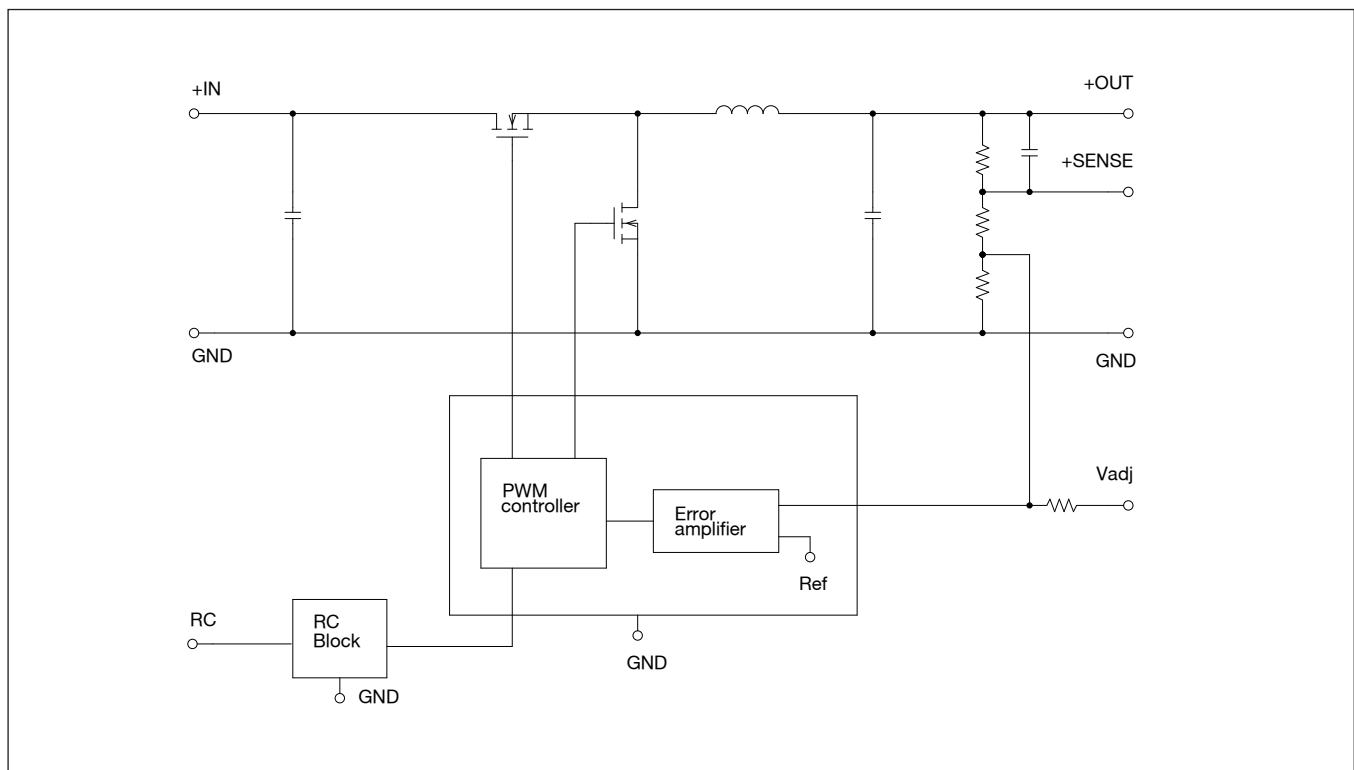

## Product Qualification Specification

Characteristics			
Random Vibration	JESD 22-B103-B	Frequency Acceleration density	2 ... 500 Hz 0.008 ... 0.2 g <sup>2</sup> /Hz
Sinusoidal vibration	JESD 22-B103-B	Frequency Acceleration	10 ... 1000 Hz 10 g
Mechanical shock (half sinus)	JESD 22-B104-B	Peak acceleration Duration	200 g 1.5 ms
Lead integrity	JESD 22-B105-C	Weight of 1000 g	All terminals
Temperature cycling	JESD 22-A104-B	Temperature Number of cycles	-40 ... +125 °C 300
Accelerated damp heat	JESD 22-A101-B	Temperature Humidity Duration Bias	+85 °C 85 % RH 1000 hours max input voltage
Solderability	IEC 60068-2-54 (Aged according to JESD 22- A101-B, 240h no bias)	Solder immersion depth Time for onset of wetting Wetting force	1 mm < 4 s > 100 mN/m
Cold (in operation)	IEC 60068-2-1A, test A <sub>d</sub>	Temperature Duration	-45 °C 72 h
High temperature storage	JESD 22-A103-B	Temperature Duration	+125 °C 1000 h

## Safety Specification

### General information.

Ericsson Power Modules DC/DC converters and DC/DC regulators are designed in accordance with safety standards IEC/EN/UL 60 950, *Safety of Information Technology Equipment*.

IEC/EN/UL60950 contains requirements to prevent injury or damage due to the following hazards:

- *Electrical shock*
- *Energy hazards*
- *Fire*
- *Mechanical and heat hazards*
- *Radiation hazards*
- *Chemical hazards*

On-board DC-DC converters are defined as component power supplies. As components they cannot fully comply with the provisions of any Safety requirements without "Conditions of Acceptability". It is the responsibility of the installer to ensure that the final product housing these components complies with the requirements of all applicable Safety standards and Directives for the final product.

Component power supplies for general use should comply with the requirements in IEC60950, EN60950 and UL60950 "Safety of information technology equipment".

There are other more product related standards, e.g. IEC61204-7 "Safety standard for power supplies", IEEE802.3af "Ethernet LAN/MAN Data terminal equipment power", and ETS300132-2 "Power supply interface at the input to telecommunications equipment; part 2: DC", but all of these standards are based on IEC/EN/UL60950 with regards to safety.

Ericsson Power Modules DC/DC converters and DC/DC regulators are UL 60 950 recognized and certified in accordance with EN 60 950.

The flammability rating for all construction parts of the products meets UL 94V-0.

The products should be installed in the end-use equipment, in accordance with the requirements of the ultimate application. Normally the output of the DC/DC converter is considered as SELV (Safety Extra Low Voltage) and the input source must be isolated by minimum Double or Reinforced Insulation from the primary circuit (AC mains) in accordance with IEC/EN/UL 60 950.

### Isolated DC/DC converters.

It is recommended that a fast blow fuse with a rating twice the maximum input current per selected product be used at the input of each DC/DC converter. If an input filter is used in the circuit the fuse should be placed in front of the input filter.

In the rare event of a component problem in the input filter or in the DC/DC converter that imposes a short circuit on the input source, this fuse will provide the following functions:

- Isolate the faulty DC/DC converter from the input power source so as not to affect the operation of other parts of the system.
- Protect the distribution wiring from excessive current and power loss thus preventing hazardous overheating.

The galvanic isolation is verified in an electric strength test. The test voltage ( $V_{ISO}$ ) between input and output is 1500 Vdc or 2250 Vdc for 60 seconds (refer to product specification). Leakage current is less than 1 $\mu$ A at nominal input voltage.

### 24 V dc systems.

The input voltage to the DC/DC converter is SELV (Safety Extra Low Voltage) and the output remains SELV under normal and abnormal operating conditions.

### 48 and 60 V dc systems.

If the input voltage to Ericsson Power Modules DC/DC converter is 75 V dc or less, then the output remains SELV (Safety Extra Low Voltage) under normal and abnormal operating conditions.

Single fault testing in the input power supply circuit should be performed with the DC/DC converter connected to demonstrate that the input voltage does not exceed 75 V dc.

If the input power source circuit is a DC power system, the source may be treated as a TNV2 circuit and testing has demonstrated compliance with SELV limits and isolation requirements equivalent to Basic Insulation in accordance with IEC/EN/UL 60 950.

### Non-isolated DC/DC regulators.

The input voltage to the DC/DC regulator is SELV (Safety Extra Low Voltage) and the output remains SELV under normal and abnormal operating conditions.

It is recommended that a slow blow fuse with a rating twice the maximum input current per selected product be used at the input of each DC/DC regulator.

## Adjusted to 1.0 V out - Data

$T_{ref} = -30 \dots +90 \text{ }^\circ\text{C}$ ,  $V_I = 3.0 \dots 5.5 \text{ V}$  unless otherwise specified. Input filter  $2 \times 22 \text{ } \mu\text{F}$ , Output filter  $1 \times 150 \text{ } \mu\text{F}$   
 Typ values specified at:  $T_{ref} = +25 \text{ }^\circ\text{C}$  and  $V_{Inom}$ .  $I_{Omax} = 10 \text{ A}$ . Note: +Sense connected to +Out

Characteristics		Conditions	Output			Unit
			min	typ	max	
$V_{O1}$	Output voltage adjusted setting	$T_{ref} = +25 \text{ }^\circ\text{C}$ , $V_{Inom}$ , $I_{Omax}$ , $R_{adj} 80 \text{ k}\Omega$	0.98	1.00	1.02	V
$V_O$	Output voltage tolerance band	$I_O = 0.01 \dots 1.0 \times I_{Omax}$	0.97		1.03	V
	Idling voltage	$I_O = 0$	0.98		1.02	V
	Line regulation	$V_{Imin} \dots V_{Imax}$ , $I_{Omax}$		11		mV
	Load regulation	$I_O = 0.01 \dots 1.0 \times I_{Omax}$ , $V_{Inom}$		10		mV
$V_{tr}$	Load transient voltage deviation	Load step = $0.25 \dots 0.75 \times I_{Omax}$ , $di/dt = 5 \text{ A}/\mu\text{s}$ , $C_O = 150 \text{ } \mu\text{F}$ , $V_I = 3.3 \text{ V}$		100		mV
$t_{tr}$	Load transient recovery time			60		$\mu\text{s}$
$T_{coeff}$	Temperature coefficient	$T_{ref} = -30 \dots +90 \text{ }^\circ\text{C}$ , $I_{Omax}$	-0.1	0	+0.1	mV/ $^\circ\text{C}$
$t_s$	Start-up time	From $V_I$ connected to $V_O = 0.9 \times V_{O1}$ , $I_O = 0.1 \dots 1.0 \times I_{Omax}$ , $V_{Inom}$		8.5		ms
$t_r$	Ramp-up time	$0.1 \dots 0.9 \times V_O$ , $I_O = 0.1 \dots 1.0 \times I_{Omax}$ , $V_{Inom}$		4		ms
$t_f$	Fall time, $V_O \times 0.1$	$I_O = I_{Omax}$ , $V_{Inom}$		0.2		ms
$t_f$	Fall time, $V_O \times 0.1$	$I_O = 0 \text{ A}$ , $V_{Inom}$		5		s
$t_{RCoff}$	RC shut-down time to $V_O \times 0.1$	$I_O = I_{Omax}$ , $V_{Inom}$		0.2		ms
$t_{RCOn}$	RC start-up time to $V_O \times 0.9$	$I_O = I_{Omax}$ , $V_{Inom}$		8		ms
$t_{RC}$	RC fall time, $V_O \times 0.1 \dots 0.9$	$I_O = 0 \text{ A}$ , $V_{Inom}$		10		s
$I_O$	Output current		0		10	A
$P_{Omax}$	Max output power	At $V_O = V_{Onom}$	10			W
$I_{lim}$	Current limit threshold	$T_{ref} < T_{refmax}$	16	20	24	A
$V_{Oac}$	Output ripple	20 Hz ... 5 MHz, $I_{Omax}$		10	20	mV <sub>p-p</sub>
$\eta$	Efficiency - 50% load	$I_O = 0.5 \times I_{Omax}$ , $V_I = 5 \text{ V}$		88.4		%
$\eta$	Efficiency - 100% load	$I_O = I_{Omax}$ , $V_I = 5 \text{ V}$	84.5	87.1		%
$P_d$	Power Dissipation	$I_O = I_{Omax}$ , $V_I = 5 \text{ V}$		1.6	1.8	W
$F_o$	Switching frequency	$I_O = 0 \dots 1.0 \times I_{Omax}$	250	300	350	kHz
$I_{sense}$	Remote sense current				8	mA
$I_I$	Static input current	$V_I = 3.0 \text{ V}$ , $I_O = I_{Omax}$ , $T_{ref} = 25 \text{ }^\circ\text{C}$		3.9		A
MTBF	Predicted reliability	$T_{ref} = 40 \text{ }^\circ\text{C}$		6		million hours

## Adjusted to 1.0 V out - Typical Characteristics

General conditions: Input filter 2 x 22  $\mu$ F, Output filter 1 x 150  $\mu$ F

### Efficiency

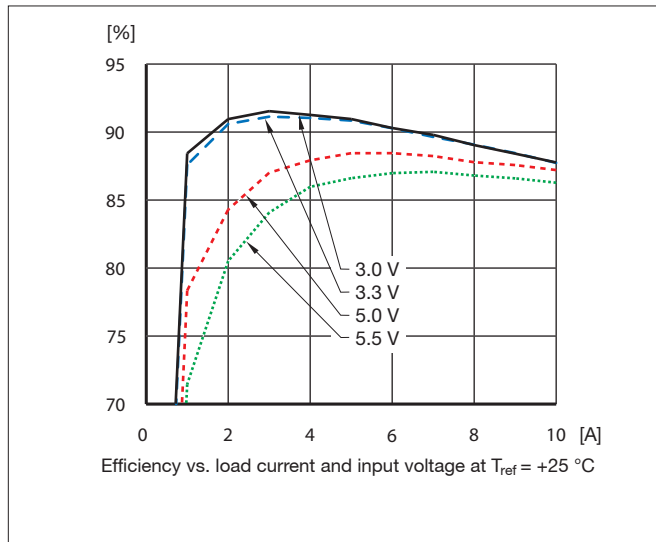

### Power Dissipation

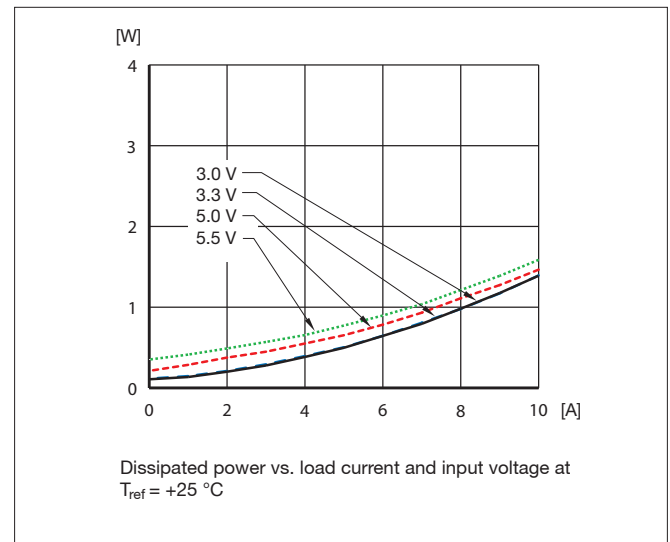

### Output Current Derating at 3.3 V input

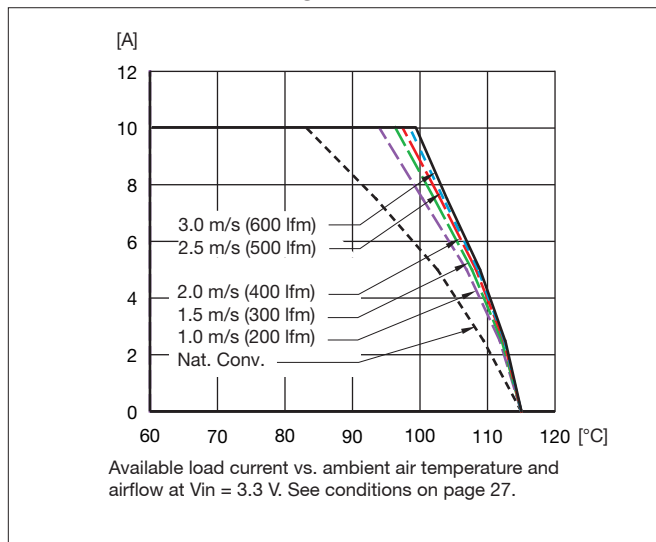

### Output Current Derating at 5 V input

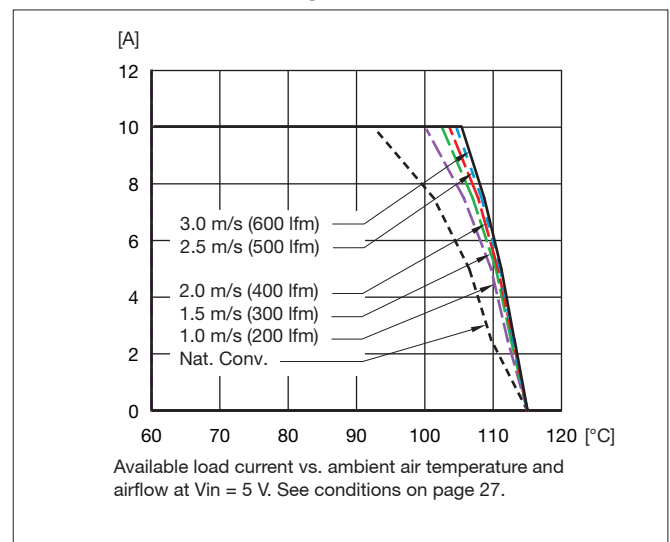

### Output Characteristics

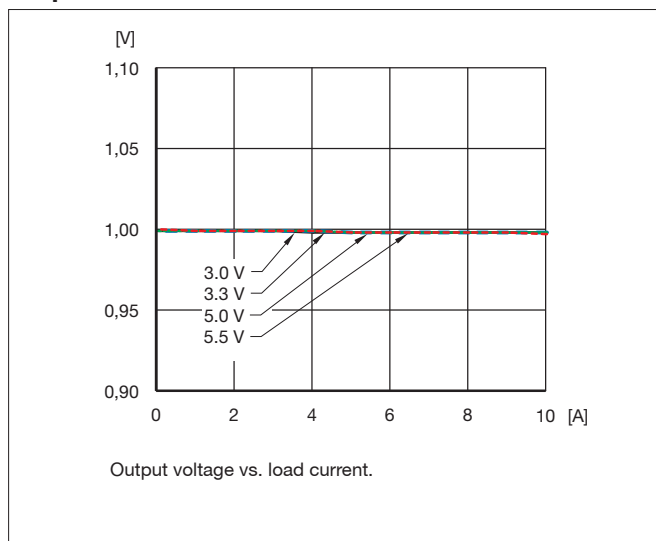

### Start-Up

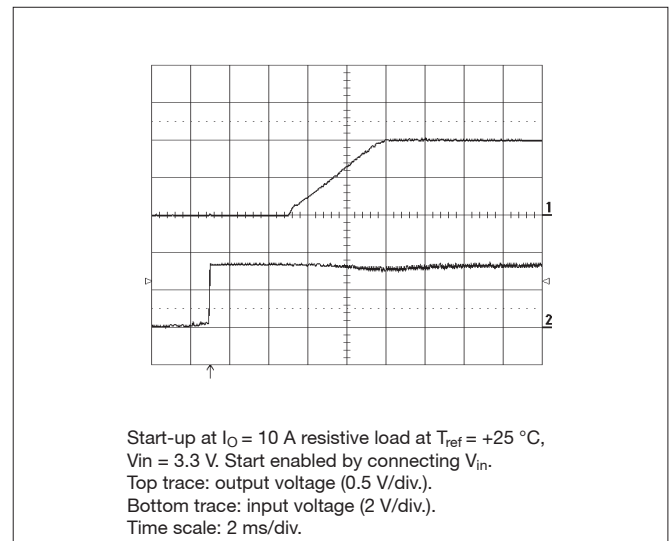



## Adjusted to 1.0 V out - Typical Characteristics

General conditions: Input filter 2 x 22  $\mu$ F, Output filter 1 x 150  $\mu$ F

### Turn Off

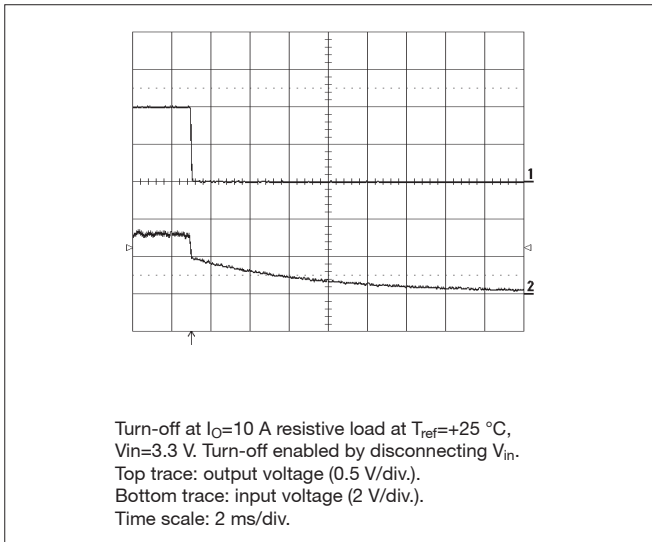

### Output Ripple

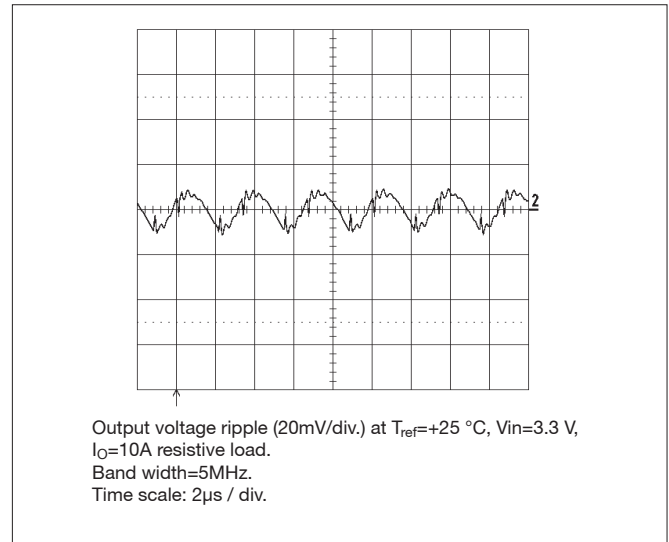

### Transient with 150 $\mu$ F output capacitor

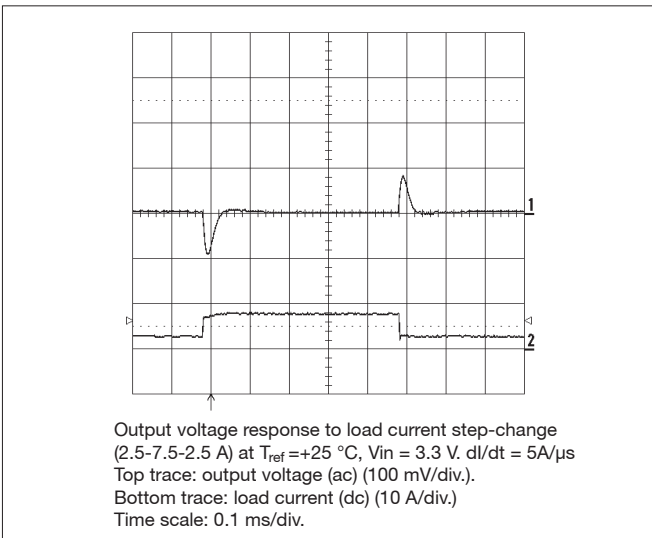

### Transient with 300 $\mu$ F output capacitor

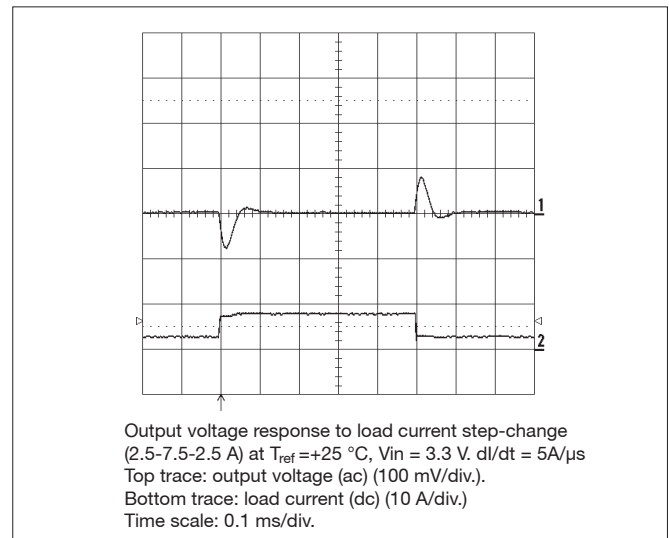

## Adjusted to 1.2 V out - Data

$T_{ref} = -30 \dots +90 \text{ }^\circ\text{C}$ ,  $V_I = 3.0 \dots 5.5 \text{ V}$  unless otherwise specified. Input filter  $2 \times 22 \text{ } \mu\text{F}$ , Output filter  $1 \times 150 \text{ } \mu\text{F}$   
 Typ values specified at:  $T_{ref} = +25 \text{ }^\circ\text{C}$  and  $V_{Inom}$ ,  $I_{Omax} = 10 \text{ A}$ . Note: +Sense connected to +Out

Characteristics		Conditions	Output			Unit
			min	typ	max	
$V_{OI}$	Output voltage adjusted setting	$T_{ref} = +25 \text{ }^\circ\text{C}$ , $V_{Inom}$ , $I_{Omax}$ , $R_{adj} 42 \text{ k}\Omega$	1.176	1.20	1.224	V
$V_O$	Output voltage tolerance band	$I_O = 0.01 \dots 1.0 \times I_{Omax}$	1.164		1.236	V
	Idling voltage	$I_O = 0$	1.18		1.22	V
	Line regulation	$V_{Imin} \dots V_{Imax}$ , $I_{Omax}$		11		mV
	Load regulation	$I_O = 0.01 \dots 1.0 \times I_{Omax}$ , $V_{Inom}$		10		mV
$V_{tr}$	Load transient voltage deviation	Load step = $0.25 \dots 0.75 \times I_{Omax}$ , $dI/dt = 5 \text{ A}/\mu\text{s}$ , $C_O = 150 \text{ } \mu\text{F}$ , $V_I = 3.3 \text{ V}$		100		mV
$t_{tr}$	Load transient recovery time			60		$\mu\text{s}$
$T_{coeff}$	Temperature coefficient	$T_{ref} = -30 \dots +90 \text{ }^\circ\text{C}$ , $I_{Omax}$	-0.1	0	+0.1	$\text{mV}/^\circ\text{C}$
$t_s$	Start-up time	From $V_I$ connected to $V_O = 0.9 \times V_{OI}$ , $I_O = 0.1 \dots 1.0 \times I_{Omax}$ , $V_{Inom}$		8.5		ms
$t_r$	Ramp-up time	$0.1 \dots 0.9 \times V_O$ , $I_O = 0.1 \dots 1.0 \times I_{Omax}$ , $V_{Inom}$		4		ms
$t_f$	Fall time, $V_O \times 0.1$	$I_O = I_{Omax}$ , $V_{Inom}$		0.2		ms
$t_f$	Fall time, $V_O \times 0.1$	$I_O = 0 \text{ A}$ , $V_{Inom}$		5		s
$t_{RCoff}$	RC shut-down time to $V_O \times 0.1$	$I_O = I_{Omax}$ , $V_{Inom}$		0.2		ms
$t_{RCOn}$	RC start-up time to $V_O \times 0.9$	$I_O = I_{Omax}$ , $V_{Inom}$		8		ms
$t_{RC}$	RC fall time, $V_O \times 0.1 \dots 0.9$	$I_O = 0 \text{ A}$ , $V_{Inom}$		5		s
$I_O$	Output current		0		10	A
$P_{Omax}$	Max output power	At $V_O = V_{Onom}$	12			W
$I_{lim}$	Current limit threshold	$T_{ref} < T_{refmax}$	16	20	24	A
$V_{Oac}$	Output ripple	20 Hz ... 5 MHz, $I_{Omax}$		10	20	$\text{mV}_{p-p}$
$\eta$	Efficiency - 50% load	$I_O = 0.5 \times I_{Omax}$ , $V_I = 5 \text{ V}$		89.7		%
$\eta$	Efficiency - 100% load	$I_O = I_{Omax}$ , $V_I = 5 \text{ V}$	86.5	88.6		%
$P_d$	Power Dissipation	$I_O = I_{Omax}$ , $V_I = 5 \text{ V}$		1.5	1.9	W
$F_o$	Switching frequency	$I_O = 0 \dots 1.0 \times I_{Omax}$	250	300	350	kHz
$I_{sense}$	Remote sense current				8	mA
$I_I$	Static input current	$V_I = 3.0 \text{ V}$ , $I_O = I_{Omax}$ , $T_{ref} = 25 \text{ }^\circ\text{C}$		4.5		A
MTBF	Predicted reliability	$T_{ref} = 40 \text{ }^\circ\text{C}$		6		million hours

## Adjusted to 1.2 V - Typical Characteristics

General conditions: Input filter 2 x 22  $\mu$ F, Output filter 1 x 150  $\mu$ F

### Efficiency

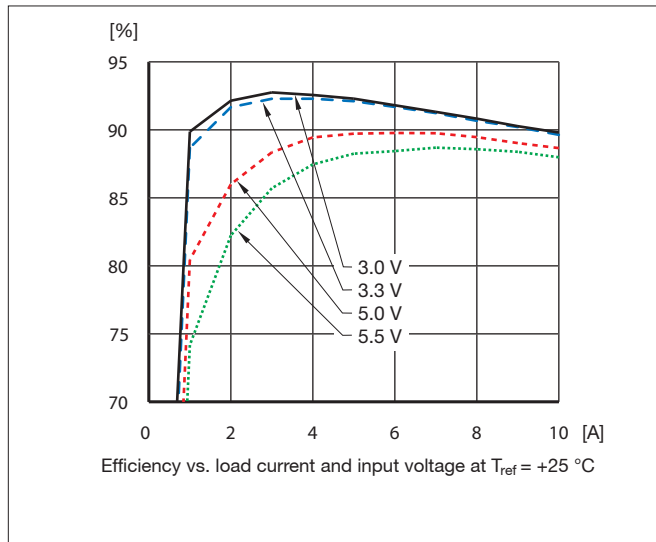

### Power Dissipation

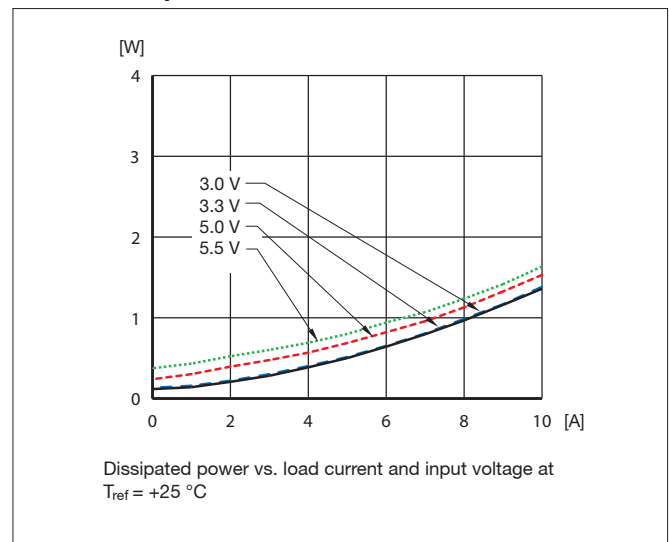

### Output Current Derating at 3.3 V input

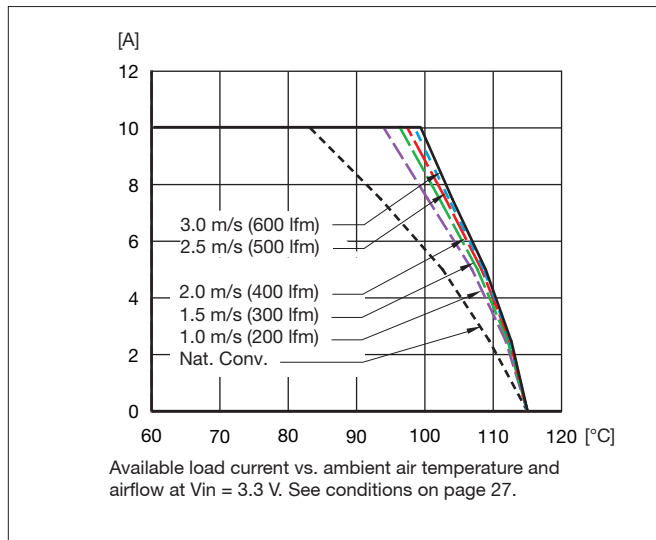

### Output Current Derating at 5 V input

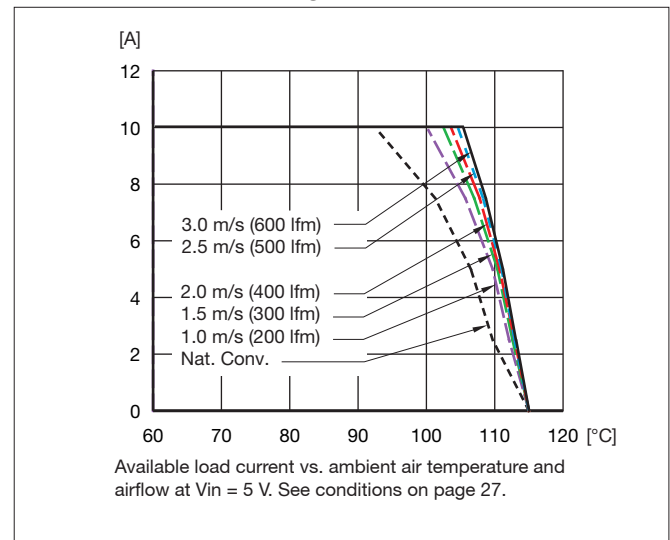

### Output Characteristic

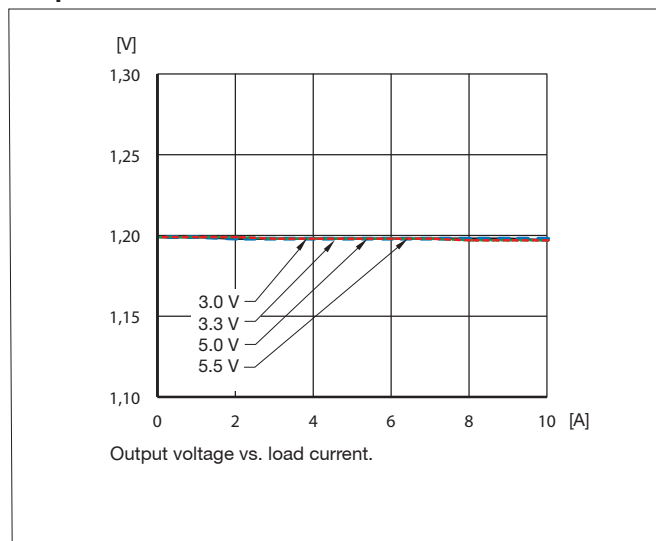

### Start-Up

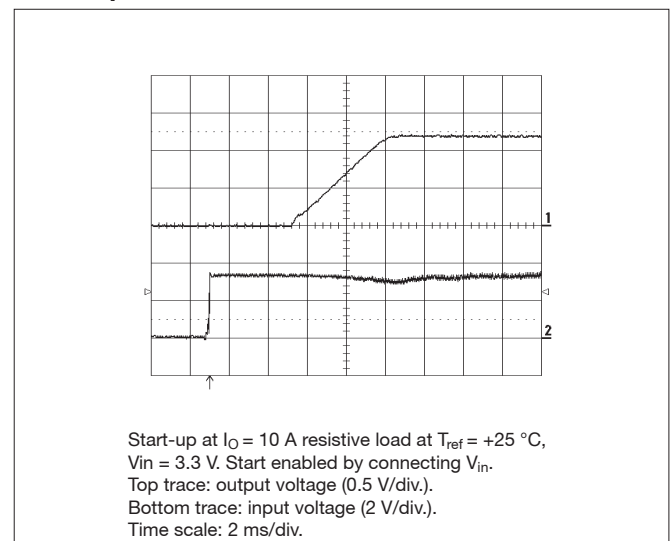

## Adjusted to 1.2 V - Typical Characteristics

General conditions: Input filter 2 x 22  $\mu$ F, Output filter 1 x 150  $\mu$ F

### Turn Off

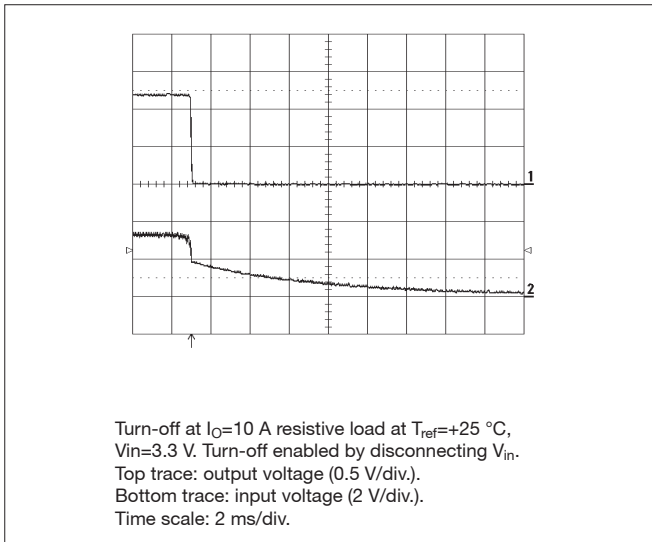

### Output Ripple

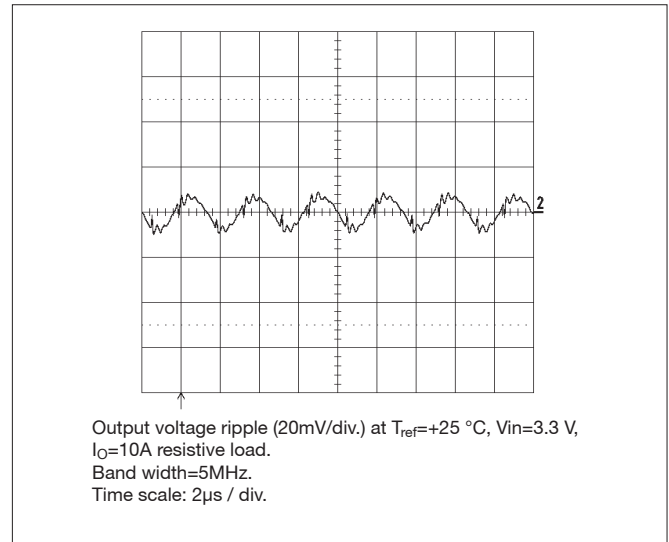

### Transient with 150 $\mu$ F output capacitor

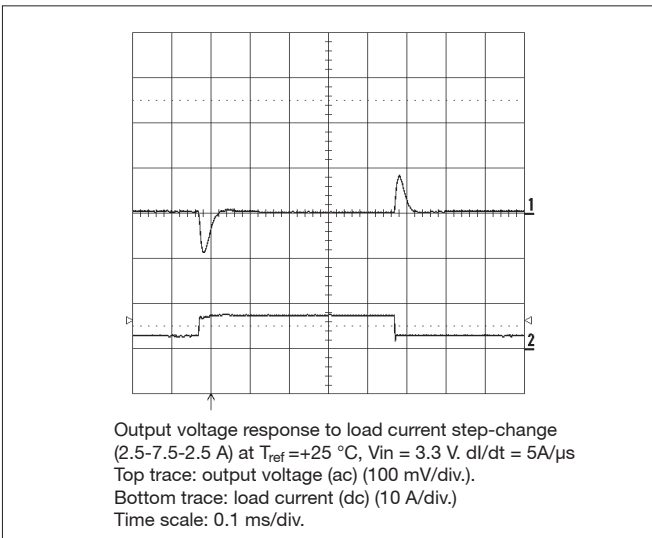

### Transient with 300 $\mu$ F output capacitor

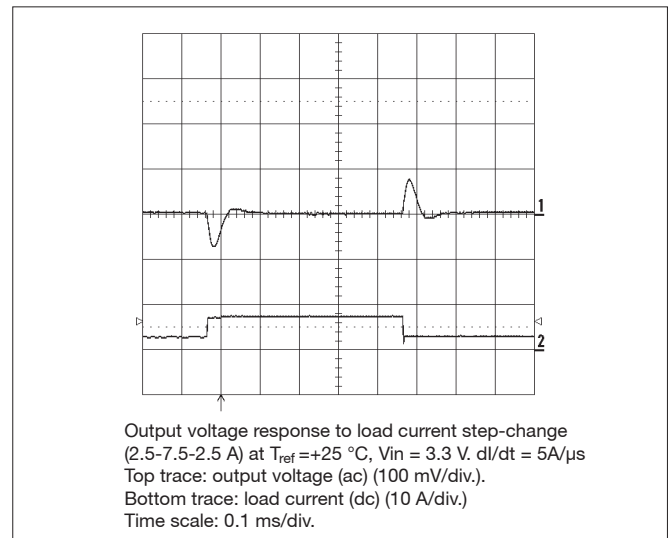

## Adjusted to 1.5 V out - Data

$T_{ref} = -30 \dots +90 \text{ }^\circ\text{C}$ ,  $V_I = 3.0 \dots 5.5 \text{ V}$  unless otherwise specified. Input filter  $2 \times 22 \text{ } \mu\text{F}$ , Output filter  $1 \times 150 \text{ } \mu\text{F}$   
 Typ values specified at:  $T_{ref} = +25 \text{ }^\circ\text{C}$  and  $V_{Inom}$ .  $I_{Omax} = 10 \text{ A}$ . Note: +Sense connected to +Out

Characteristics		Conditions	Output			Unit
			min	typ	max	
$V_{OI}$	Output voltage adjusted setting	$T_{ref} = +25 \text{ }^\circ\text{C}$ , $V_{Inom}$ , $I_{Omax}$ , $R_{adj} 23 \text{ k}\Omega$	1.47	1.5	1.53	V
$V_O$	Output voltage tolerance band	$I_O = 0.01 \dots 1.0 \times I_{Omax}$	1.455		1.545	V
	Idling voltage	$I_O = 0$	1.48		1.52	V
	Line regulation	$V_{Imin} \dots V_{Imax}$ , $I_{Omax}$		11		mV
	Load regulation	$I_O = 0.01 \dots 1.0 \times I_{Omax}$ , $V_{Inom}$		10		mV
$V_{tr}$	Load transient voltage deviation	Load step = $0.25 \dots 0.75 \times I_{Omax}$ , $dI/dt = 5 \text{ A}/\mu\text{s}$ , $C_O = 150 \text{ } \mu\text{F}$ , $V_I = 3.3 \text{ V}$		100		mV
$t_{tr}$	Load transient recovery time			60		$\mu\text{s}$
$T_{coeff}$	Temperature coefficient	$T_{ref} = -30 \dots +90 \text{ }^\circ\text{C}$ , $I_{Omax}$	-0.1	0	+0.1	$\text{mV}/^\circ\text{C}$
$t_s$	Start-up time	From $V_I$ connected to $V_O = 0.9 \times V_{OI}$ , $I_O = 0.1 \dots 1.0 \times I_{Omax}$ , $V_{Inom}$		8.5		ms
$t_r$	Ramp-up time	$0.1 \dots 0.9 \times V_O$ , $I_O = 0.1 \dots 1.0 \times I_{Omax}$ , $V_{Inom}$		4		ms
$t_f$	Fall time, $V_O \times 0.1$	$I_O = I_{Omax}$ , $V_{Inom}$		0.2		ms
$t_f$	Fall time, $V_O \times 0.1$	$I_O = 0 \text{ A}$ , $V_{Inom}$		5		s
$t_{RCoff}$	RC shut-down time to $V_O \times 0.1$	$I_O = I_{Omax}$ , $V_{Inom}$		0.2		ms
$t_{RCOn}$	RC start-up time to $V_O \times 0.9$	$I_O = I_{Omax}$ , $V_{Inom}$		8		ms
$t_{RC}$	RC fall time, $V_O \times 0.1 \dots 0.9$	$I_O = 0 \text{ A}$ , $V_{Inom}$		5		s
$I_O$	Output current		0		10	A
$P_{Omax}$	Max output power	At $V_O = V_{Onom}$	15			W
$I_{lim}$	Current limit threshold	$T_{ref} < T_{refmax}$	16	20	24	A
$V_{Oac}$	Output ripple	20Hz ... 5MHz, $I_{Omax}$		15	25	$\text{mV}_{p-p}$
$\eta$	Efficiency - 50% load	$I_O = 0.5 \times I_{Omax}$ , $V_I = 5 \text{ V}$		92		%
$\eta$	Efficiency - 100% load	$I_O = I_{Omax}$ , $V_I = 5 \text{ V}$	88	90.5		%
$P_d$	Power Dissipation	$I_O = I_{Omax}$ , $V_I = 5 \text{ V}$		1.6	2.1	W
$F_o$	Switching frequency	$I_O = 0 \dots 1.0 \times I_{Omax}$	250	300	350	kHz
$I_{sense}$	Remote sense current				8	mA
$I_I$	Static input current	$V_I = 3.0 \text{ V}$ , $I_O = I_{Omax}$ , $T_{ref} = 25 \text{ }^\circ\text{C}$		5.5		A
MTBF	Predicted reliability	$T_{ref} = 40 \text{ }^\circ\text{C}$		6		million hours

## Adjusted to 1.5V out - Typical Characteristics

General conditions: Input filter 2 x 22  $\mu$ F, Output filter 1 x 150  $\mu$ F

### Efficiency

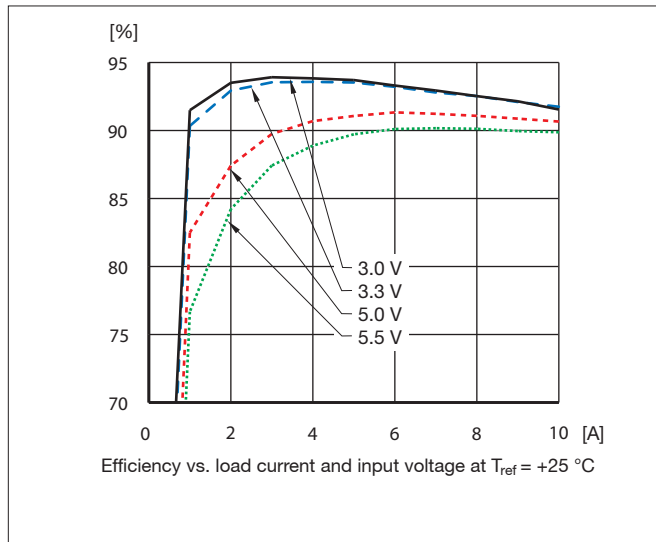

### Power Dissipation

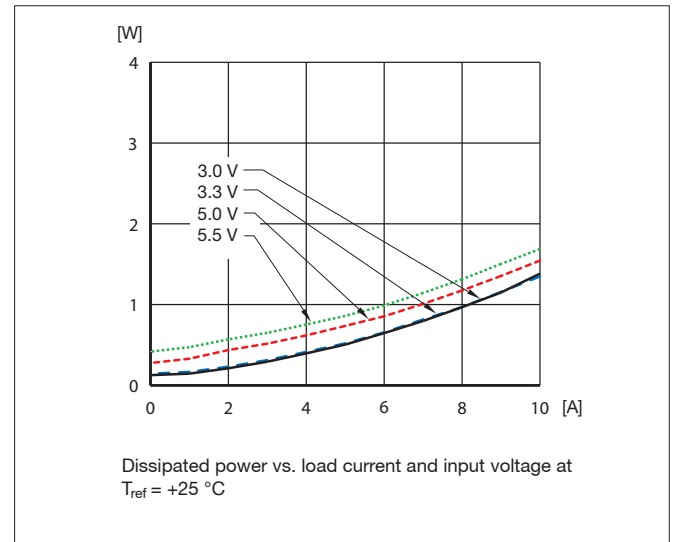

### Output Current Derating at 3.3 V input

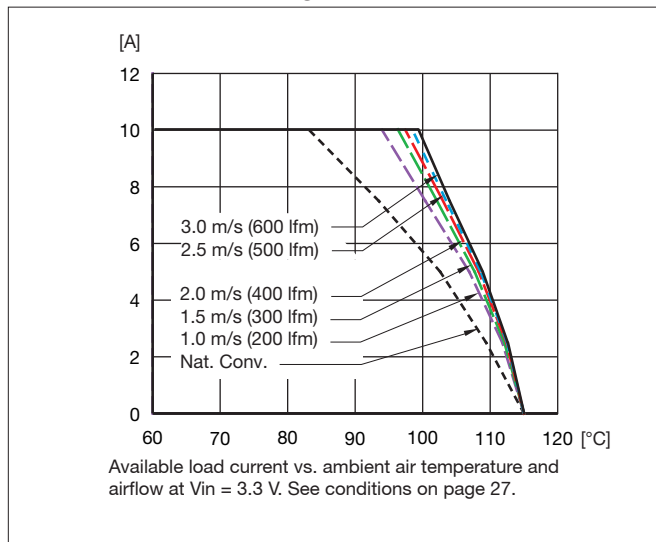

### Output Current Derating at 5 V input

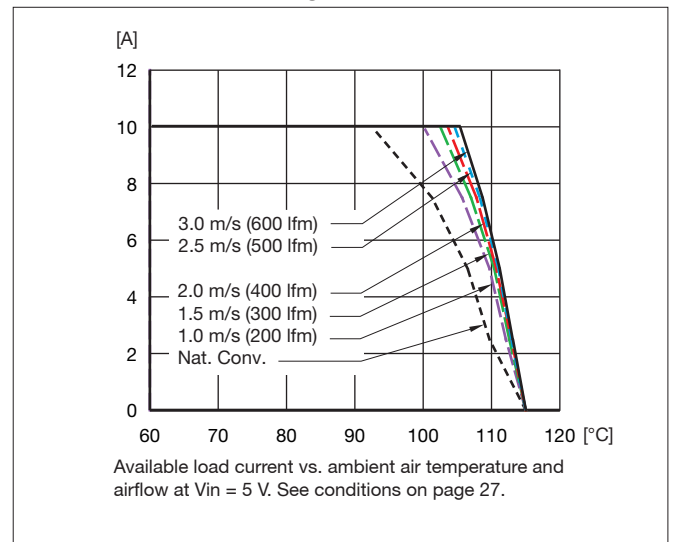

### Output Characteristic

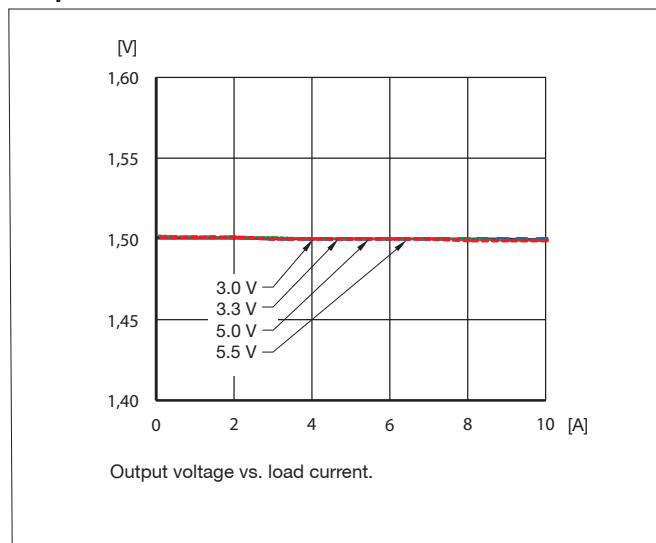

### Start-Up

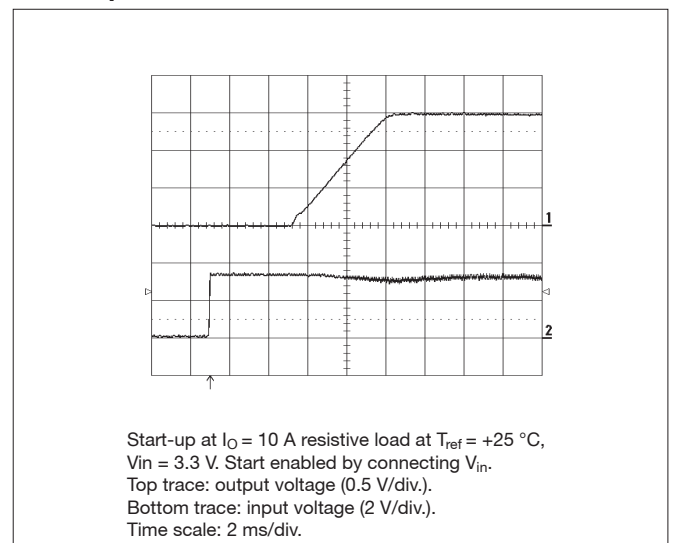

## Adjusted to 1.5V out - Typical Characteristics

General conditions: Input filter 2 x 22  $\mu$ F, Output filter 1 x 150  $\mu$ F

### Turn Off

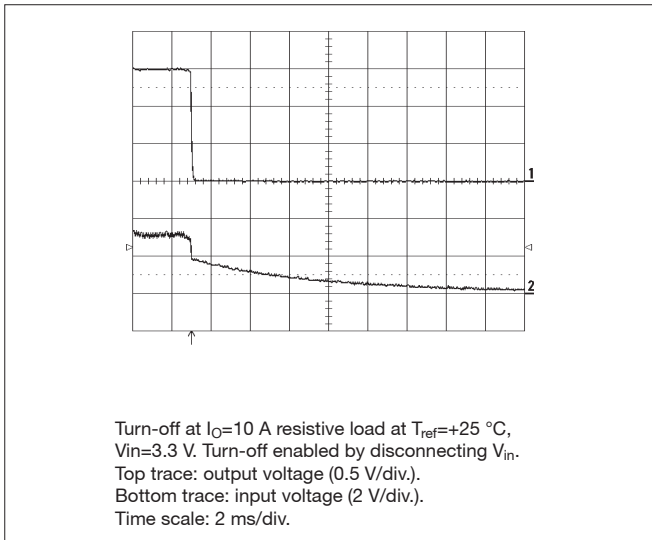

### Output Ripple

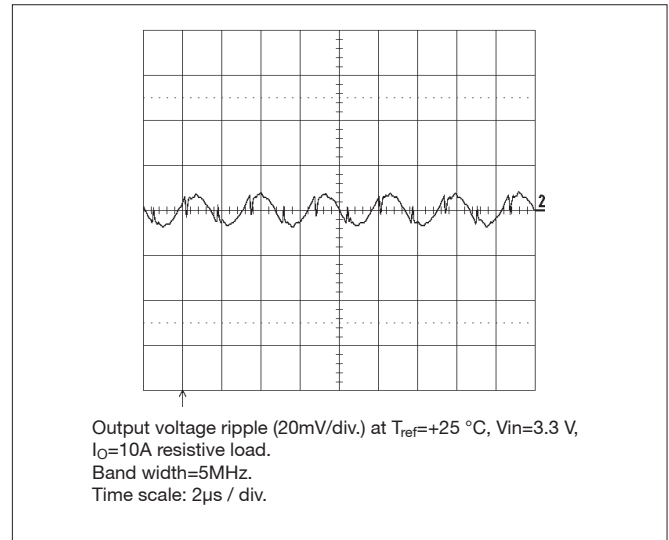

### Transient with 150 $\mu$ F output capacitor

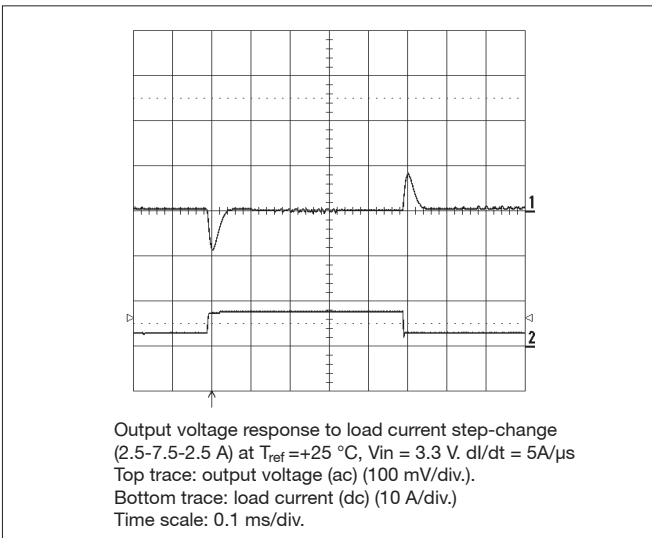

### Transient with 300 $\mu$ F output capacitor

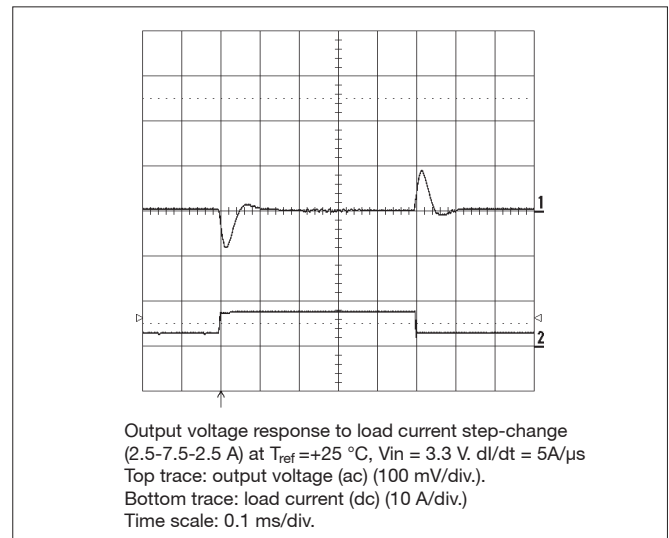

## Adjusted to 1.8 V out - Data

$T_{ref} = -30 \dots +90 \text{ }^\circ\text{C}$ ,  $V_I = 3.0 \dots 5.5 \text{ V}$  unless otherwise specified. Input filter  $2 \times 22 \text{ } \mu\text{F}$ , Output filter  $1 \times 150 \text{ } \mu\text{F}$   
 Typ values specified at:  $T_{ref} = +25 \text{ }^\circ\text{C}$  and  $V_{Inom}$ .  $I_{Omax} = 10 \text{ A}$ . Note: +Sense connected to +Out

Characteristics		Conditions	Output			Unit
			min	typ	max	
$V_{OI}$	Output voltage adjusted setting	$T_{ref} = +25 \text{ }^\circ\text{C}$ , $V_{Inom}$ , $I_{Omax}$ , $R_{adj} 15 \text{ k}\Omega$	1.764	1.80	1.836	V
$V_O$	Output voltage tolerance band	$I_O = 0.01 \dots 1.0 \times I_{Omax}$	1.746		1.854	V
	Idling voltage	$I_O = 0$	1.78		1.82	V
	Line regulation	$V_{Imin} \dots V_{Imax}$ , $I_{Omax}$		11		mV
	Load regulation	$I_O = 0.01 \dots 1.0 \times I_{Omax}$ , $V_{Inom}$		10		mV
$V_{tr}$	Load transient voltage deviation	Load step = $0.25 \dots 0.75 \times I_{Omax}$ , $di/dt = 5 \text{ A}/\mu\text{s}$ , $C_O = 150 \text{ } \mu\text{F}$ , $V_I = 3.3 \text{ V}$		110		mV
$t_{tr}$	Load transient recovery time			60		$\mu\text{s}$
$T_{coeff}$	Temperature coefficient	$T_{ref} = -30 \dots +90 \text{ }^\circ\text{C}$ , $I_{Omax}$	-0.1	0	+0.1	mV/ $^\circ\text{C}$
$t_s$	Start-up time	From $V_I$ connected to $V_O = 0.9 \times V_{OI}$ , $I_O = 0.1 \dots 1.0 \times I_{Omax}$ , $V_{Inom}$		8.5		ms
$t_r$	Ramp-up time	$0.1 \dots 0.9 \times V_O$ , $I_O = 0.1 \dots 1.0 \times I_{Omax}$ , $V_{Inom}$		4		ms
$t_f$	Fall time, $V_O \times 0.1$	$I_O = I_{Omax}$ , $V_{Inom}$		0.2		ms
$t_f$	Fall time, $V_O \times 0.1$	$I_O = 0 \text{ A}$ , $V_{Inom}$		5		s
$t_{RCoff}$	RC shut-down time to $V_O \times 0.1$	$I_O = I_{Omax}$ , $V_{Inom}$		0.2		ms
$t_{RCOn}$	RC start-up time to $V_O \times 0.9$	$I_O = I_{Omax}$ , $V_{Inom}$		8		ms
$t_{RC}$	RC fall time, $V_O \times 0.1 \dots 0.9$	$I_O = 0 \text{ A}$ , $V_{Inom}$		5		s
$I_O$	Output current		0		10	A
$P_{Omax}$	Max output power	At $V_O = V_{Onom}$	18			W
$I_{lim}$	Current limit threshold	$T_{ref} < T_{refmax}$	16	20	24	A
$V_{Oac}$	Output ripple	20 Hz ... 5 MHz, $I_{Omax}$		15	25	mV <sub>p-p</sub>
$\eta$	Efficiency - 50% load	$I_O = 0.5 \times I_{Omax}$ , $V_I = 5 \text{ V}$		92.4		%
$\eta$	Efficiency - 100% load	$I_O = I_{Omax}$ , $V_I = 5 \text{ V}$	90	92.1		%
$P_d$	Power Dissipation	$I_O = I_{Omax}$ , $V_I = 5 \text{ V}$		1.6	2.0	W
$F_o$	Switching frequency	$I_O = 0 \dots 1.0 \times I_{Omax}$	250	300	350	kHz
$I_{sense}$	Remote sense current				8	mA
$I_i$	Static input current	$V_I = 3.0 \text{ V}$ , $I_O = I_{Omax}$ , $T_{ref} = 25 \text{ }^\circ\text{C}$		6.5		A
MTBF	Predicted reliability	$T_{ref} = 40 \text{ }^\circ\text{C}$		6		million hours



## Adjusted to 1.8 V - Typical Characteristics

General conditions: Input filter 2 x 22  $\mu$ F, Output filter 1 x 150  $\mu$ F

### Efficiency

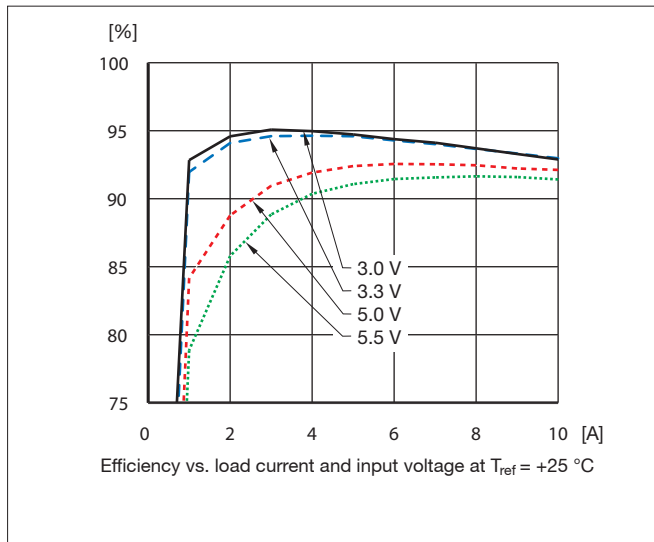

### Power Dissipation

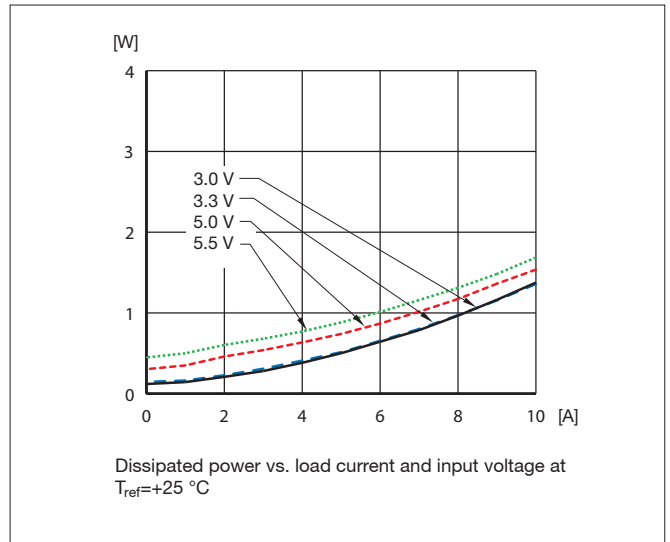

### Output Current Derating at 3.3 V input

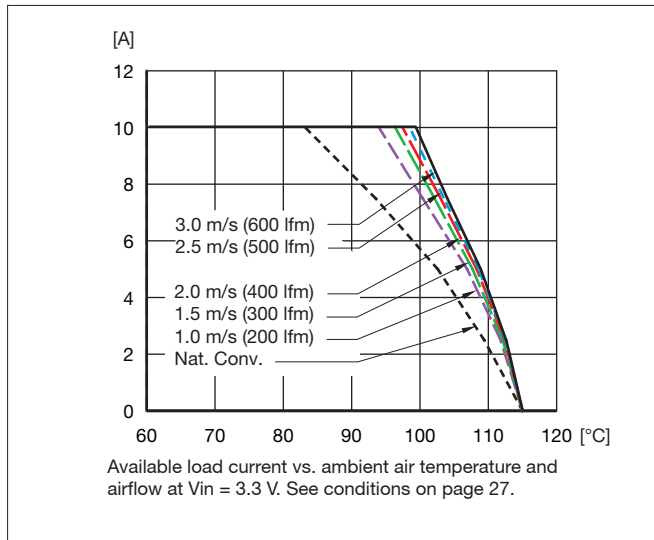

### Output Current Derating at 5 V input

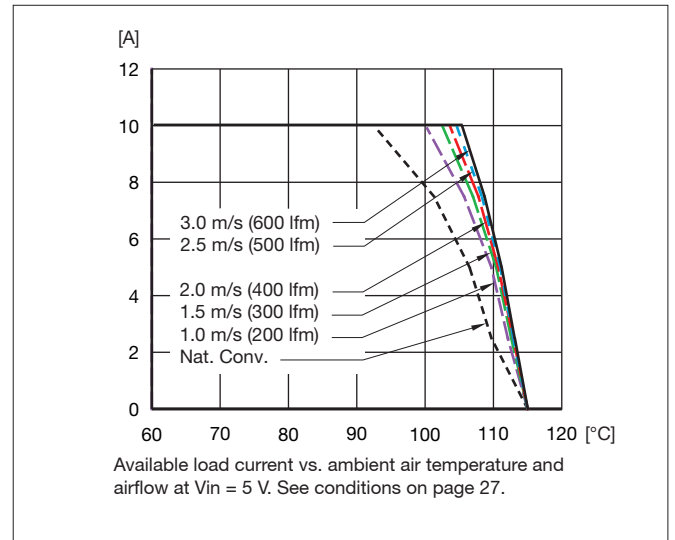

### Output Characteristic

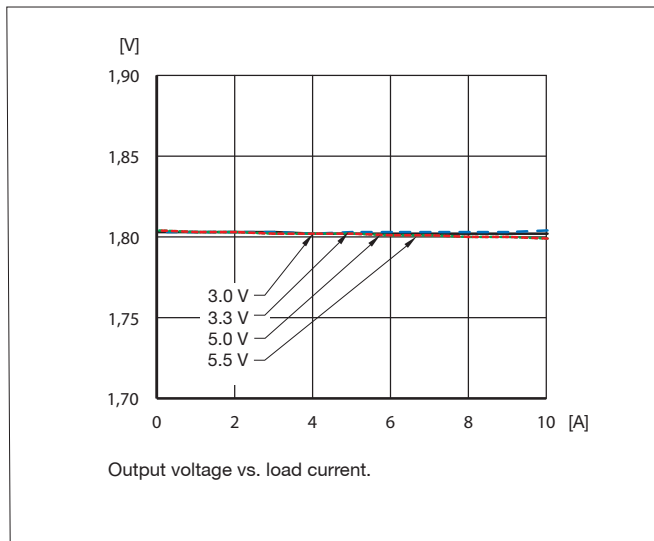

### Start-Up

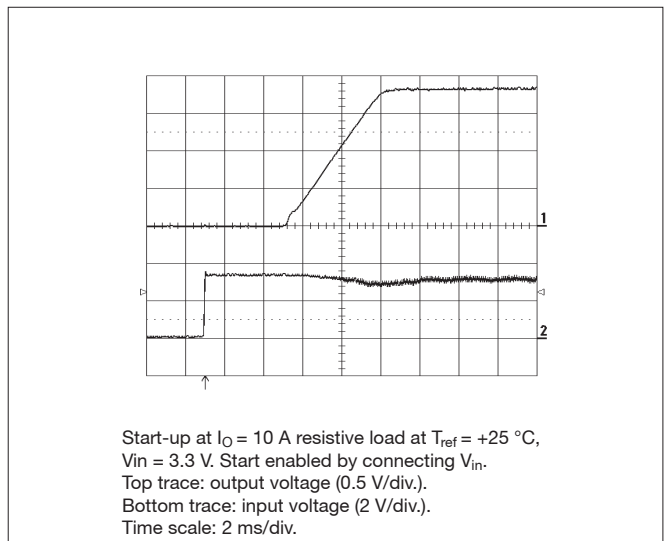

## Adjusted to 1.8 V out - Typical Characteristics

General conditions: Input filter 2 x 22  $\mu$ F, Output filter 1 x 150  $\mu$ F

### Turn Off

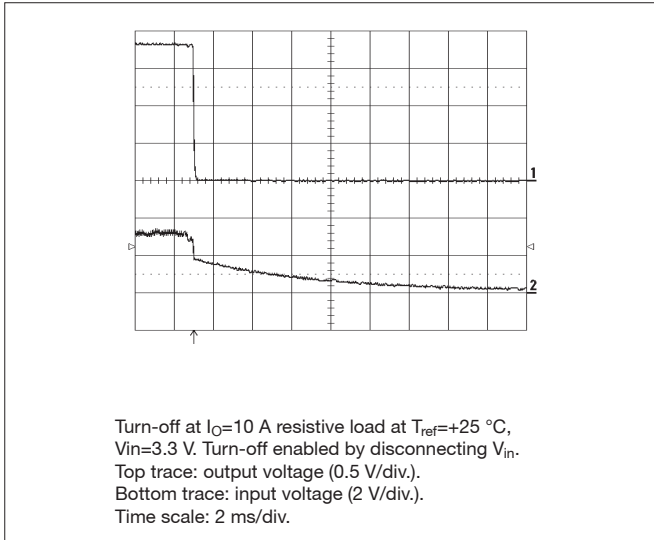

### Output Ripple

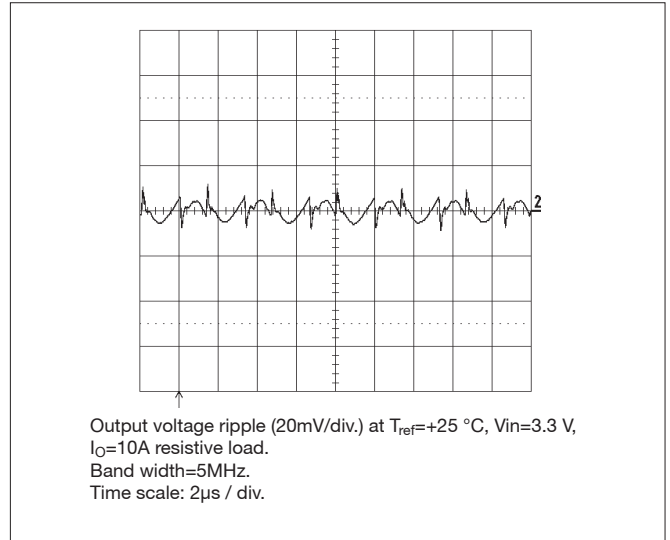

### Transient with 150 $\mu$ F output capacitor

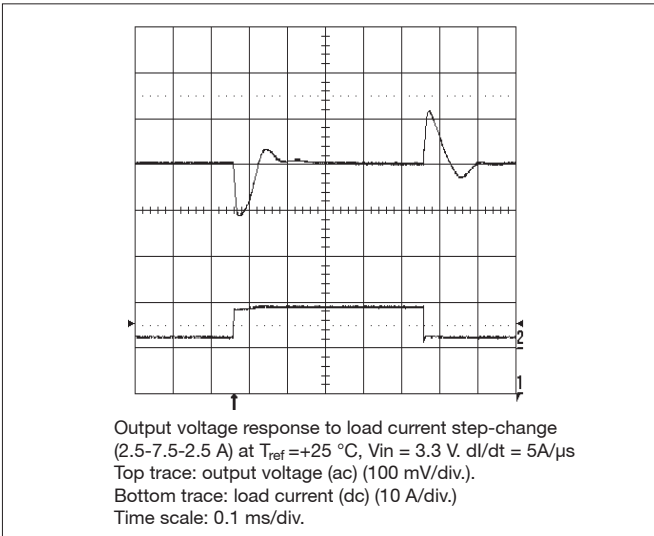

### Transient with 300 $\mu$ F output capacitor

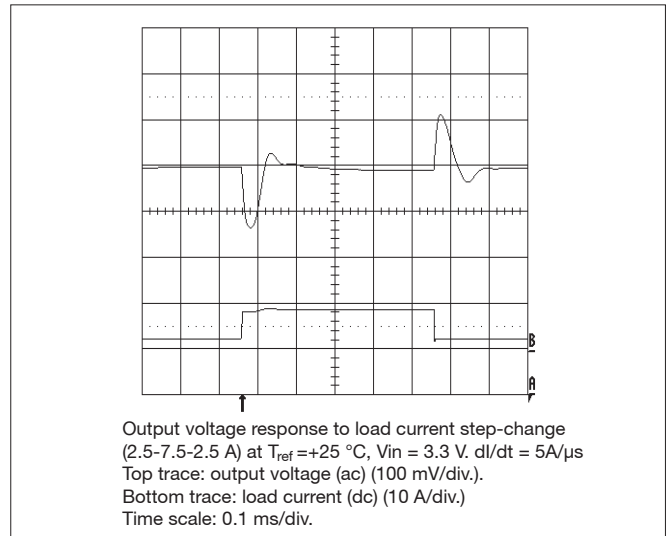

## Adjusted to 2.5 V out - Data

$T_{ref} = -30 \dots +90 \text{ }^\circ\text{C}$ ,  $V_I = 3.0 \dots 5.5 \text{ V}$  unless otherwise specified. Input filter  $2 \times 22 \text{ } \mu\text{F}$ , Output filter  $1 \times 150 \text{ } \mu\text{F}$   
 Typ values specified at:  $T_{ref} = +25 \text{ }^\circ\text{C}$  and  $V_{Inom}$ .  $I_{Omax} = 10 \text{ A}$ . Note: +Sense connected to +Out

Characteristics		Conditions	Output			Unit
			min	typ	max	
$V_{O1}$	Output voltage adjusted setting	$T_{ref} = +25 \text{ }^\circ\text{C}$ , $V_{Inom}$ , $I_{Omax}$ , $R_{adj} 7 \text{ k}\Omega$	2.45	2.5	2.55	V
$V_O$	Output voltage tolerance band	$I_O = 0.01 \dots 1.0 \times I_{Omax}$	2.425		2.575	V
	Idling voltage	$I_O = 0$	2.48		2.52	V
	Line regulation	$V_{Imin} \dots V_{Imax}$ , $I_{Omax}$		11		mV
	Load regulation	$I_O = 0.01 \dots 1.0 \times I_{Omax}$ , $V_{Inom}$		10		mV
$V_{tr}$	Load transient voltage deviation	Load step = $0.25 \dots 0.75 \times I_{Omax}$ , $dl/dt = 5 \text{ A}/\mu\text{s}$ , $C_O = 150 \text{ } \mu\text{F}$ , $V_I = 3.3 \text{ V}$		140		mV
$t_{tr}$	Load transient recovery time			60		$\mu\text{s}$
$T_{coeff}$	Temperature coefficient	$T_{ref} = -30 \dots +90 \text{ }^\circ\text{C}$ , $I_{Omax}$	-0.1	0	+0.1	mV/ $^\circ\text{C}$
$t_s$	Start-up time	From $V_I$ connected to $V_O = 0.9 \times V_{O1}$ , $I_O = 0.1 \dots 1.0 \times I_{Omax}$ , $V_{Inom}$		8.5		ms
$t_r$	Ramp-up time	$0.1 \dots 0.9 \times V_O$ , $I_O = 0.1 \dots 1.0 \times I_{Omax}$ , $V_{Inom}$		4		ms
$t_f$	Fall time, $V_O \times 0.1$	$I_O = I_{Omax}$ , $V_{Inom}$		0.2		ms
$t_f$	Fall time, $V_O \times 0.1$	$I_O = 0 \text{ A}$ , $V_{Inom}$		5		s
$t_{RCoff}$	RC shut-down time to $V_O \times 0.1$	$I_O = I_{Omax}$ , $V_{Inom}$		0.2		ms
$t_{RCOn}$	RC start-up time to $V_O \times 0.9$	$I_O = I_{Omax}$ , $V_{Inom}$		8		ms
$t_{RC}$	RC fall time, $V_O \times 0.1 \dots 0.9$	$I_O = 0 \text{ A}$ , $V_{Inom}$		5		s
$I_O$	Output current		0		10	A
$P_{Omax}$	Max output power	At $V_O = V_{Onom}$	25			W
$I_{lim}$	Current limit threshold	$T_{ref} < T_{refmax}$	16	20	24	A
$V_{Oac}$	Output ripple	20 Hz ... 5 MHz, $I_{Omax}$		20	30	mV <sub>p-p</sub>
$\eta$	Efficiency - 50% load	$I_O = 0.5 \times I_{Omax}$ , $V_I = 5 \text{ V}$		94		%
$\eta$	Efficiency - 100% load	$I_O = I_{Omax}$ , $V_I = 5 \text{ V}$	92	94		%
$P_d$	Power Dissipation	$I_O = I_{Omax}$ , $V_I = 5 \text{ V}$		1.6	2.2	W
$F_o$	Switching frequency	$I_O = 0 \dots 1.0 \times I_{Omax}$	250	300	350	kHz
$I_{sense}$	Remote sense current				8	mA
$I_I$	Static input current	$V_I = 3.0 \text{ V}$ , $I_O = I_{Omax}$ , $T_{ref} = 25 \text{ }^\circ\text{C}$		8.8		A
MTBF	Predicted reliability	$T_{ref} = 40 \text{ }^\circ\text{C}$		6		million hours

## Adjusted to 2.5 V out - Typical Characteristics

General conditions: Input filter 2 x 22  $\mu$ F, Output filter 1 x 150  $\mu$ F

### Efficiency

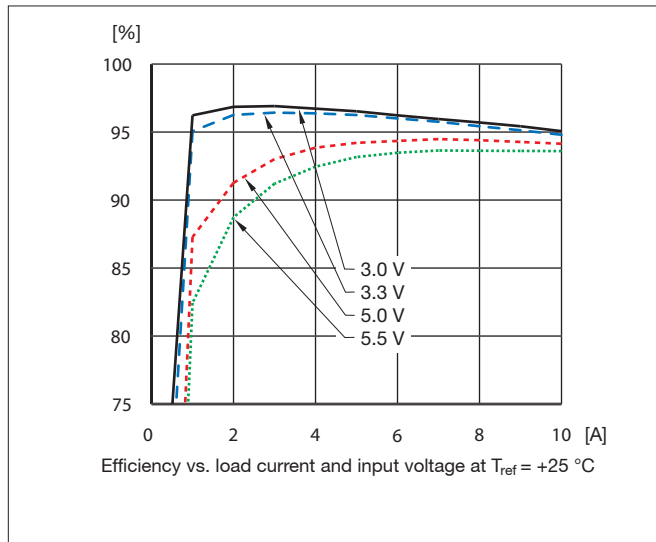

### Power Dissipation

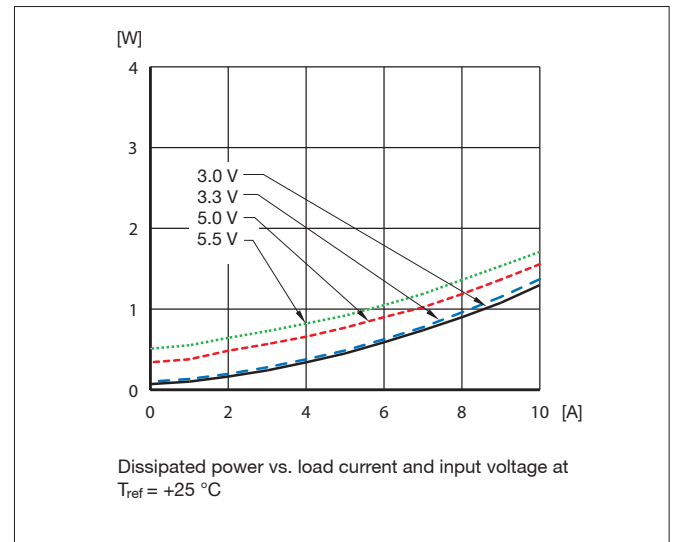

### Output Current Derating at 3.3 V input

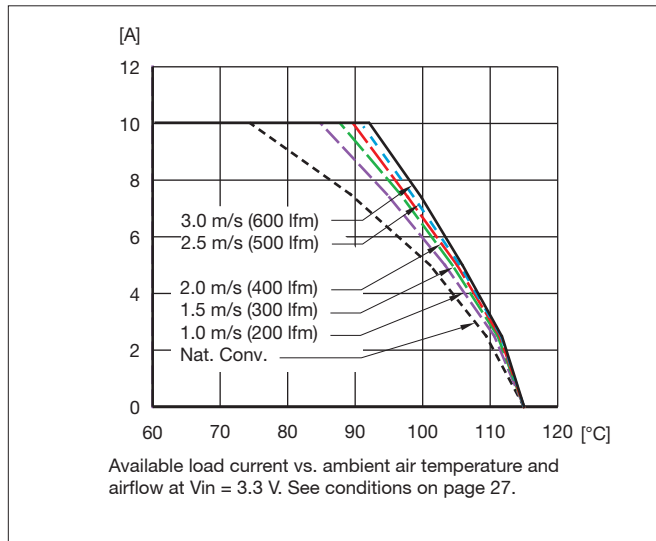

### Output Current Derating at 5 V input

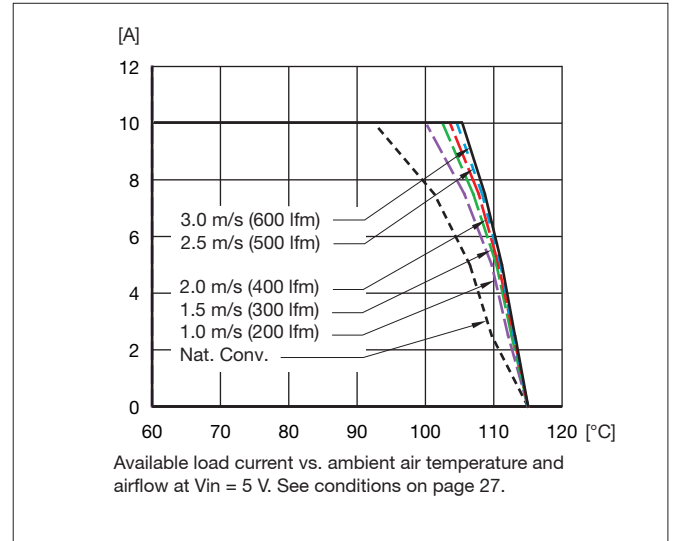

### Output Characteristic

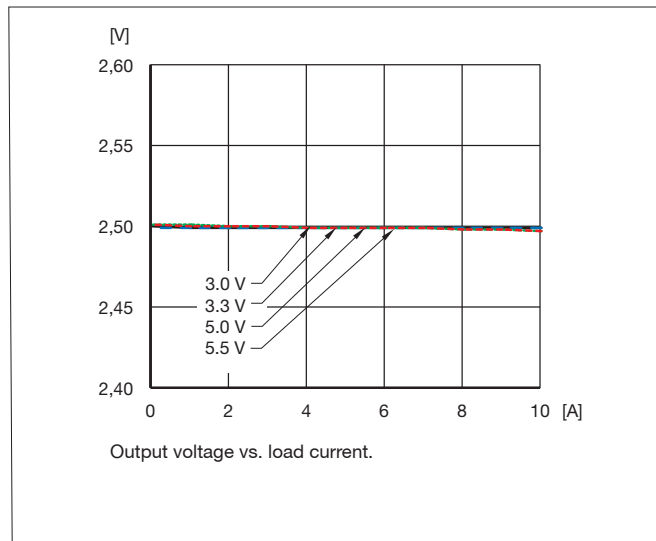

### Start-Up

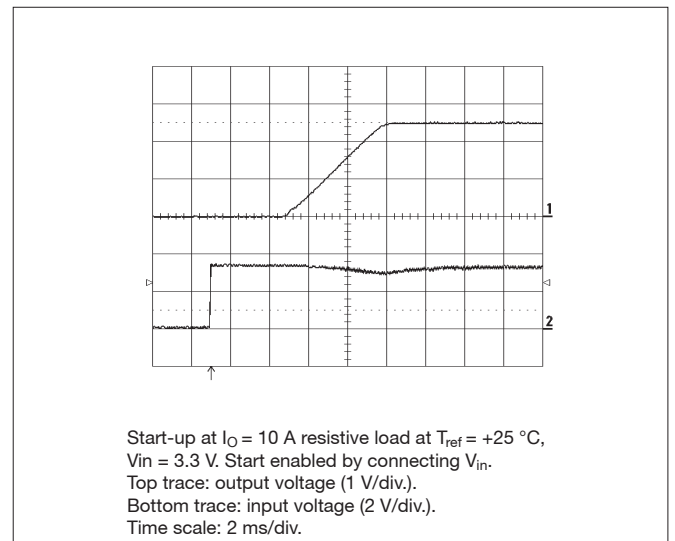

## Adjusted to 2.5 V out - Typical Characteristics

General conditions: Input filter 2 x 22  $\mu$ F, Output filter 1 x 150  $\mu$ F

### Turn Off

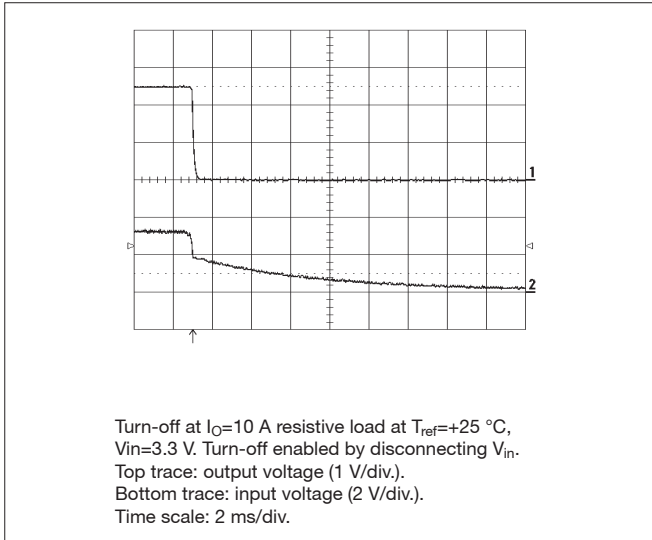

### Output Ripple

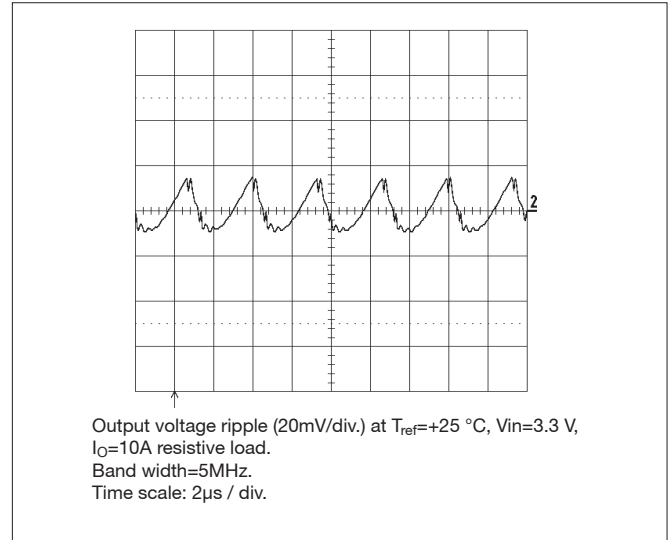

### Transient with 150 $\mu$ F output capacitor

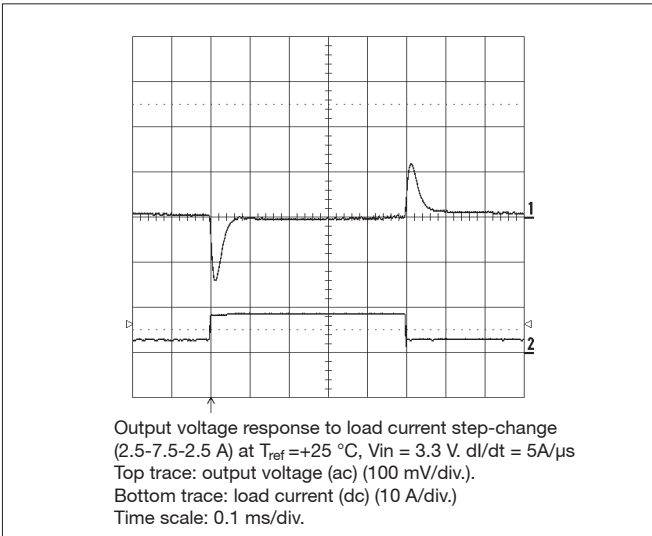

### Transient with 300 $\mu$ F output capacitor

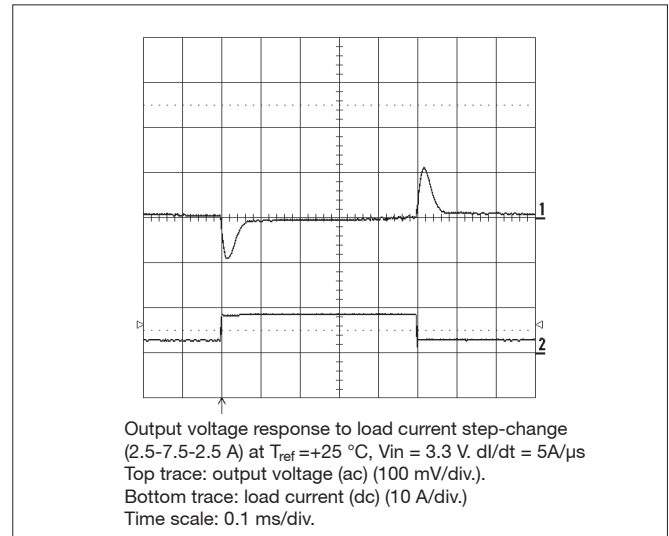

## Adjusted to 3.3 V out - Data

$T_{ref} = -30 \dots +90 \text{ }^\circ\text{C}$ ,  $V_I = 3.8 \dots 5.5 \text{ V}$  unless otherwise specified. Input filter 2 x 22  $\mu\text{F}$ , Output filter 1 x 150  $\mu\text{F}$   
Typ values specified at:  $T_{ref} = +25 \text{ }^\circ\text{C}$  and  $V_I = 5.0 \text{ V}$ .  $I_{Omax} = 10 \text{ A}$ . Note: +Sense connected to +Out

Characteristics		Conditions	Output			Unit
			min	typ	max	
$V_{O1}$	Output voltage adjusted setting	$T_{ref} = +25 \text{ }^\circ\text{C}$ , $V_I > 3.8 \text{ V}$ , $I_{Omax}$ , $R_{adj} 3.1 \text{ k}\Omega$	3.234	3.3	3.366	V
$V_O$	Output voltage tolerance band	$I_O = 0.1 \dots 1.0 \times I_{Omax}$	3.201		3.399	V
	Idling voltage	$I_O = 0$	3.28		3.32	V
	Line regulation	$V_I = 5 \text{ V} \dots V_{Imax}$ , $I_{Omax}$		11		mV
	Load regulation	$I_O = 0.01 \dots 1.0 \times I_{Omax}$ , $V_I = 5 \text{ V}$		10		mV
$V_{tr}$	Load transient voltage deviation	Load step = 0.25 ... 0.75 x $I_{Omax}$ , $dI/dt = 5 \text{ A}/\mu\text{s}$ , $C_O = 150 \mu\text{F}$ , $V_I = 5 \text{ V}$		120		mV
$t_{tr}$	Load transient recovery time			60		$\mu\text{s}$
$T_{coeff}$	Temperature coefficient	$T_{ref} = -30 \dots +90 \text{ }^\circ\text{C}$ , $I_{Omax}$	-0.1	0	+0.1	$\text{mV}/^\circ\text{C}$
$t_s$	Start-up time	From $V_I$ connected to $V_O = 0.9 \times V_{Oadj}$ , $I_O = 0.1 \dots 1.0 \times I_{Omax}$ , $V_I = 5 \text{ V}$		8.5		ms
$t_r$	Ramp-up time	$0.1 \dots 0.9 \times V_O$ , $I_O = 0.1 \dots 1.0 \times I_{Omax}$ , $V_I = 5 \text{ V}$		4		ms
$t_f$	Fall time, $V_O \times 0.1$	$I_O = I_{Omax}$ , $V_I = 5 \text{ V}$		0.2		ms
$t_f$	Fall time, $V_O \times 0.1$	$I_O = 0 \text{ A}$ , $V_I = 5 \text{ V}$		5		s
$t_{RCoff}$	RC shut-down time to $V_O \times 0.1$	$I_O = I_{Omax}$ , $V_I = 5 \text{ V}$		0.2		ms
$t_{RCOn}$	RC start-up time to $V_O \times 0.9$	$I_O = I_{Omax}$ , $V_I = 5 \text{ V}$		8		ms
$t_{RC}$	RC fall time, $V_O \times 0.1 \dots 0.9$	$I_O = 0 \text{ A}$ , $V_I = 5 \text{ V}$		5		s
$I_O$	Output current		0		10	A
$P_{Omax}$	Max output power	At $V_O = V_{Onom}$	33			W
$I_{lim}$	Current limit threshold	$T_{ref} < T_{refmax}$	16	20	24	A
$V_{Oac}$	Output ripple	20 Hz ... 5 MHz, $I_{Omax}$		20	30	$\text{mV}_{p-p}$
$\eta$	Efficiency - 50% load	$I_O = 0.5 \times I_{Omax}$ , $V_I = 5 \text{ V}$		95.7		%
$\eta$	Efficiency - 100% load	$I_O = I_{Omax}$ , $V_I = 5 \text{ V}$	93	95.4		%
$P_d$	Power Dissipation	$I_O = I_{Omax}$ , $V_I = 5 \text{ V}$		1.6	2.5	W
$F_o$	Switching frequency	$I_O = 0 \dots 1.0 \times I_{Omax}$	250	300	350	kHz
$I_{sense}$	Remote sense current				8	mA
$I_I$	Static input current	$V_I = 3.8 \text{ V}$ , $I_O = I_{Omax}$ , $T_{ref} = 25 \text{ }^\circ\text{C}$		9.2		A
MTBF	Predicted reliability	$T_{ref} = 40 \text{ }^\circ\text{C}$		6		million hours

## Adjusted to 3.3 V out - Typical Characteristics

General conditions: Input filter 2 x 22  $\mu$ F, Output filter 1 x 150  $\mu$ F

### Efficiency

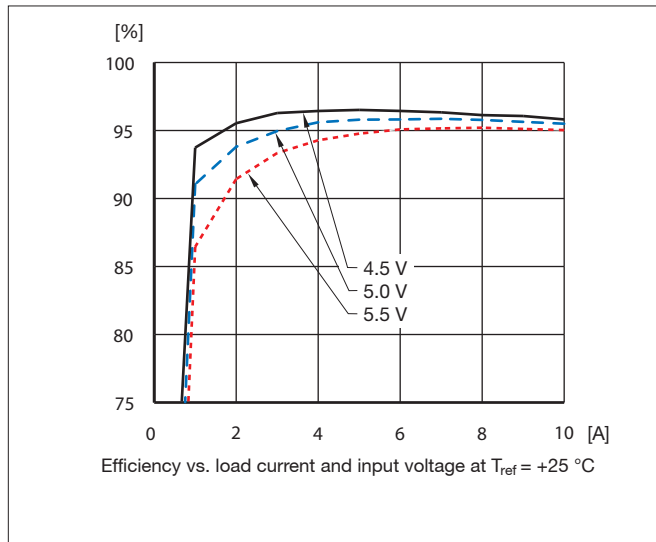

### Power Dissipation

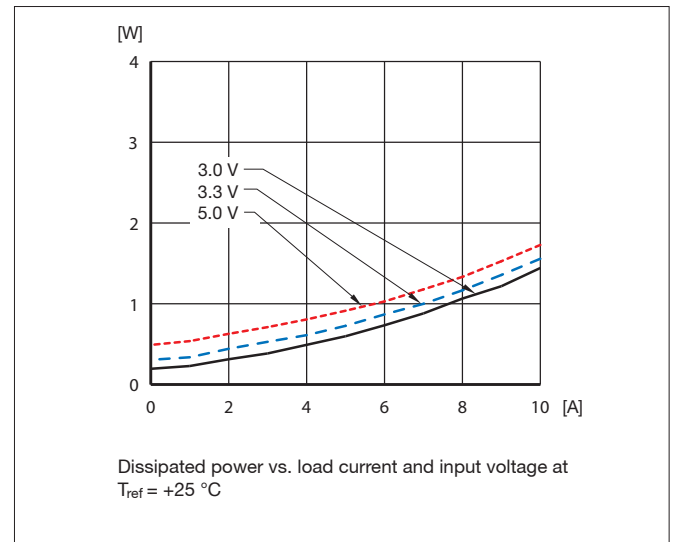

### Output Characteristic

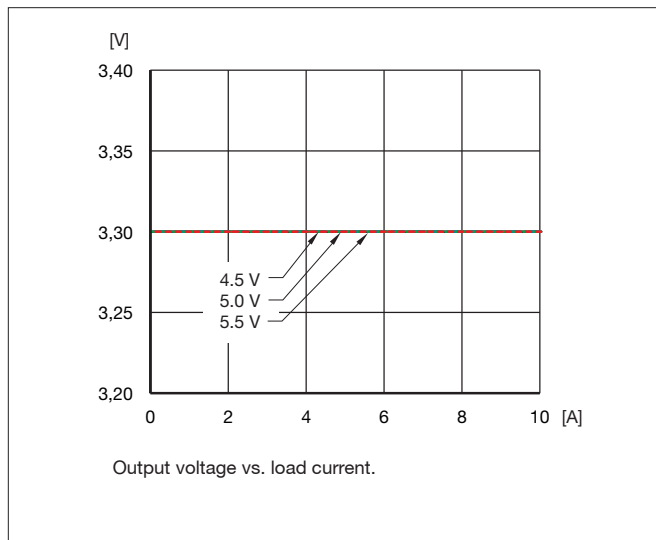

### Output Current Derating at 5 V input

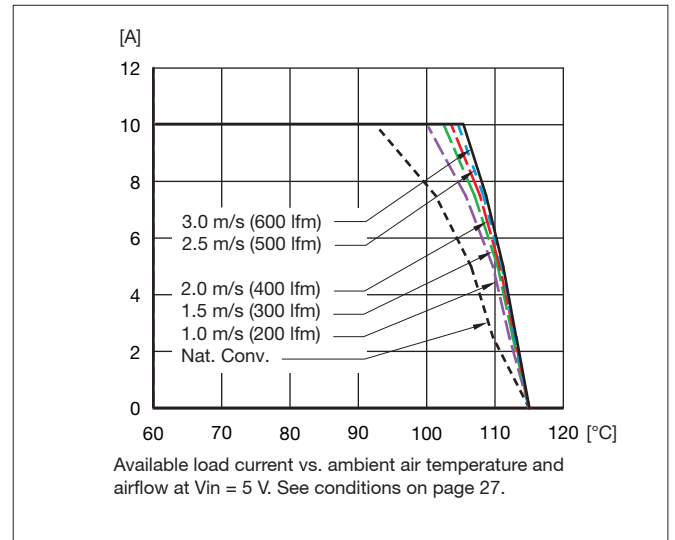

### Start-Up

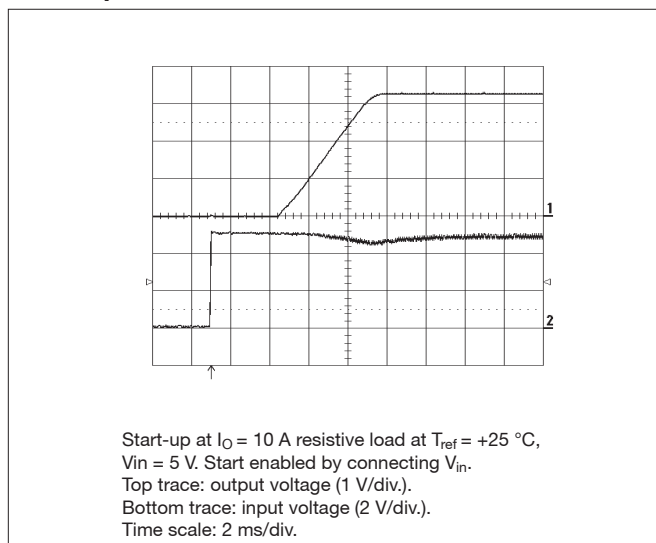

### Turn Off

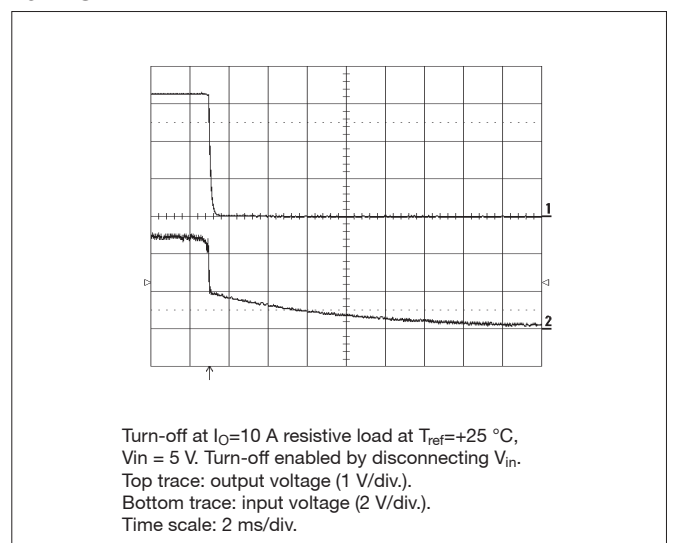

## Adjusted to 3.3 V out - Typical Characteristics

General conditions: Input filter 2 x 22  $\mu$ F, Output filter 1 x 150  $\mu$ F

### Output Ripple

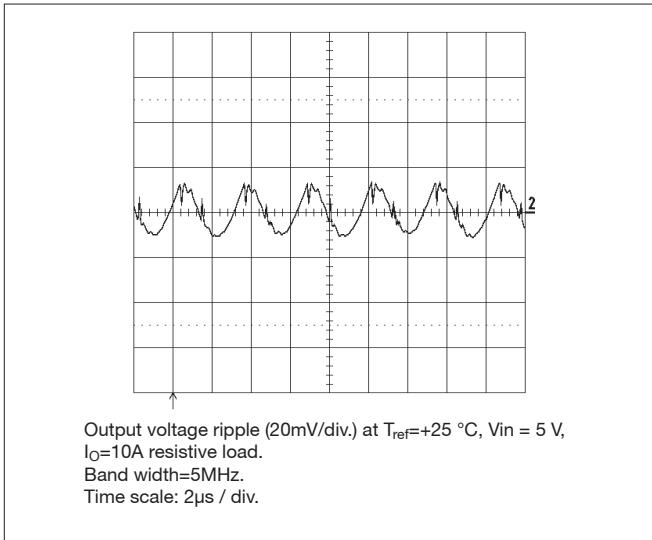

### Transient with 150 $\mu$ F output capacitor

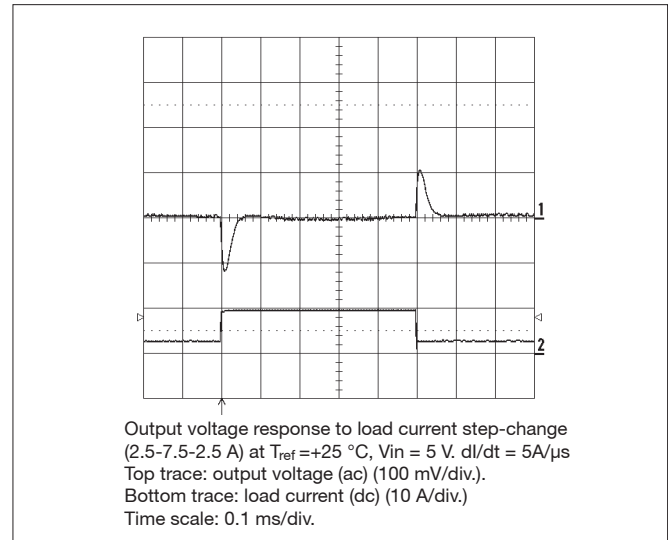

### Transient with 300 $\mu$ F output capacitor

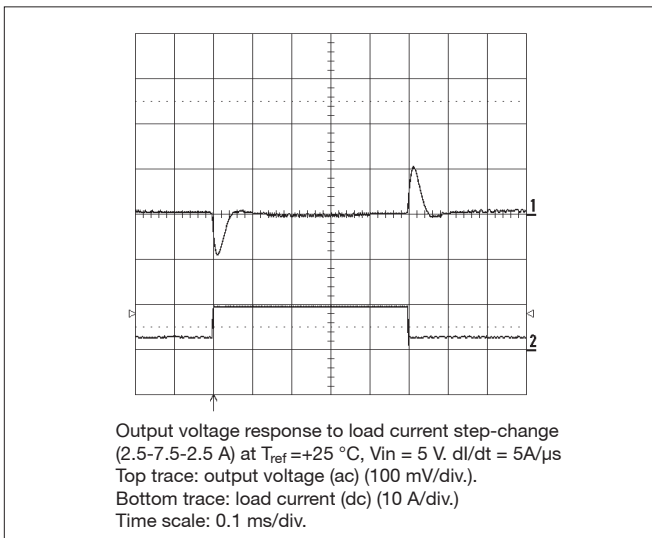



## EMC Specification

### Layout Recommendation

The radiated EMI performance of the DC/DC regulator will be optimised by including a ground plane in the PCB area under the DC/DC regulator. This approach will return switching noise to ground as directly as possible, with improvements to both emission and susceptibility.

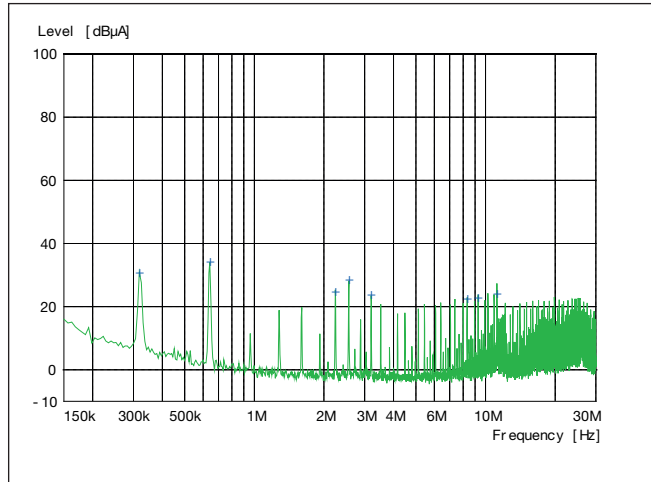

## Operating Information

### Remote Control (RC)

The RC pin may be used to turn on or turn off the regulator using a suitable open collector function. Turn off is achieved by connecting the RC pin to ground.

The regulator will run in normal operation when the RC pin is left open.

RC	Regulator condition	min	typ	max	Unit
Low level referenced to GND	OFF	-0.3		0.3	V
Open	ON	1.7		5	V

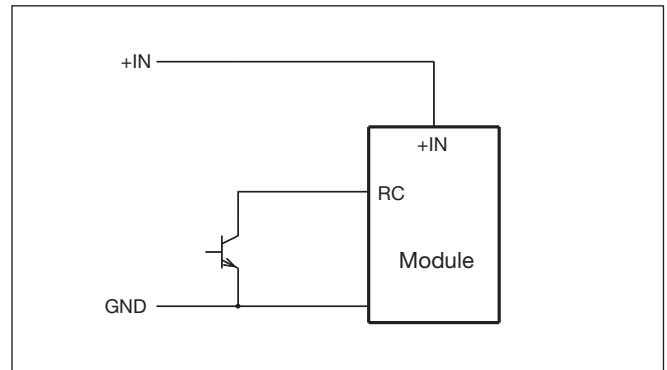

### Remote Sense

All PMC 4000 Series DC/DC regulators have a positive remote sense pin that can be used to compensate for moderate amounts of resistance in the distribution system and allow for voltage regulation at the load or other selected point. The remote sense line will carry very little current and does not need a large cross sectional area. However, the sense line on the PCB should be located close to a ground trace or ground plane. The remote sense circuitry will compensate for up to 10% voltage drop between the sense voltage and the voltage at the output pins from  $V_{O\text{nom}}$ . If the remote sense is not needed the sense pin should be left open.

## Operating Information

### Output Voltage Adjust ( $V_{adj}$ )

The output voltage can be set by means of an external resistor, connected to the  $V_{adj}$  pin. Nominal output voltage 0.75 V is set by leaving the  $V_{adj}$  pin open. Adjustment can only be made to increase the output voltage setting.

To increase:

Connect a resistor between ( $V_{adj}$ ) and (Gnd). The output voltage increases with decreasing resistor value as shown in the table below. Note that the maximum output voltage 3.63 V may not be exceeded.

$$R_{ext} \text{ up (kohm)} = (21.007 / (V_O - 0.75225)) - 5.1$$

Output Voltage (V)	Resistor (ohm)
0.75	Open
1.0	79.691 k
1.2	41.817 k
1.5	22.990 k
1.8	14.949 k
2.5	6.919 k
3.3	3.145 k

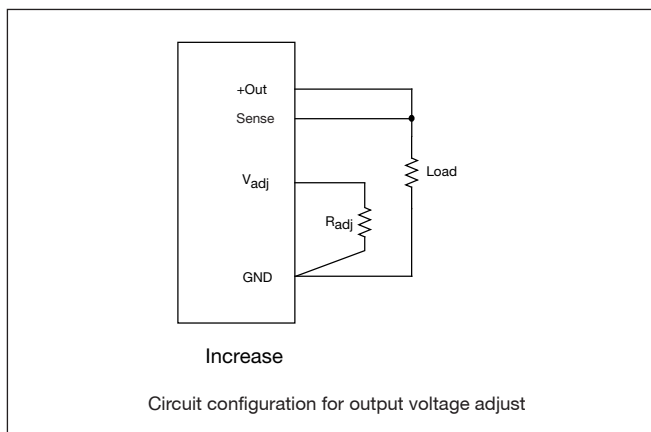

### Current Limit Protection

The PMC 4000 Series DC/DC regulators include current limiting circuitry that allows them to withstand continuous overloads or short circuit conditions on the output. The current limit is of hick-up mode type.

The regulator will resume normal operation after removal of the overload. The load distribution system should be designed to carry the maximum output short circuit current specified.

### Input And Output Impedance

The impedance of both the power source and the load will interact with the impedance of the DC/DC regulator. It is most important to have a low characteristic impedance, both at the input and output, as the regulators have a low energy storage capability. Use capacitors across the input if the source inductance is greater than 4.7  $\mu\text{H}$ . Suitable input capacitors are 22  $\mu\text{F}$  - 220  $\mu\text{F}$  low ESR ceramics.

### Minimum Required External Capacitors

External input capacitors are required to increase the lifetime of the internal capacitors and to further reduce the input ripple. A minimum of 44  $\mu\text{F}$  external input capacitance with low ESR should be added.

A minimum of 150  $\mu\text{F}$  external output capacitance, low ESR, should be added for the converter to operate properly at full load.

### Maximum Capacitive Load

When powering loads with significant dynamic current requirements, the voltage regulation at the load can be improved by addition of decoupling capacitance at the load. The most effective technique is to locate low ESR ceramic capacitors as close to the load as possible, using several capacitors to lower the total ESR. These ceramic capacitors will handle short duration high-frequency components of dynamic load changes. In addition, higher values of capacitors (electrolytic capacitors) should be used to handle the mid-frequency components. It is equally important to use good design practice when configuring the DC distribution system.

Low resistance and low inductance PCB layouts and cabling should be used. Remember that when using remote sensing, all resistance (including the ESR), inductance and capacitance of the distribution system is within the feedback loop of the regulator. This can affect on the regulators compensation and the resulting stability and dynamic response performance.

Very low ESR and high capacitance must be used with care. A "rule of thumb" is that the total capacitance must never exceed typically 500-700  $\mu\text{F}$  if only low ESR ( $< 2 \text{ m}\Omega$ ) ceramic capacitors are used. If more capacitance is needed, a combination of low ESR type and electrolytic capacitors should be used, otherwise the stability will be affected.

The PMC 4000 series regulator can accept up to 5 mF of capacitive load on the output at full load. This gives  $< 500 \mu\text{F}/\text{A}$  of  $I_O$ . When using that large capacitance it is important to consider the selection of output capacitors; the resulting behavior is a combination of the amount of capacitance and ESR.

## Operating Information

A combination of low ESR and output capacitance exceeding 5 mF can cause the regulator into over current protection mode (hick-up) due to high start up current. The output filter must therefore be designed without exceeding the above stated capacitance levels if the ESR is lower than 30-40 mΩ.

### Parallel Operation

The PMC 4000 Series DC/DC regulators can be connected in parallel with a common input. Paralleling is accomplished by connecting the output voltage pins directly and using a load sharing device on the input. Layout considerations should be made to avoid load imbalance. For more details on paralleling, please consult your local applications support.

### Input Undervoltage Lockout

The PMC 4000 Series DC/DC regulators are equipped with a lockout function for low input voltage. When the input voltage is below the undervoltage lockout limit of the regulator it will shut off. When the input voltage increases above the lockout level the regulator will turn on.

## Thermal Considerations

### General

The PMC 4000 Series DC/DC regulators are designed to operate in a variety of thermal environments, however sufficient cooling should be provided to help ensure reliable operation. Heat is removed by conduction, convection and radiation to the surrounding environment. Increased airflow enhances the heat transfer via convection. Proper cooling can be verified by measuring the temperature at the reference point ( $T_{ref}$ ).

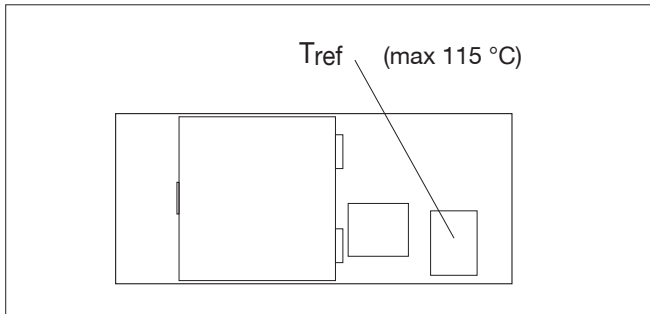

The PMC 4000 thermal testing is performed with the product mounted on an FR4 board 254 × 254 mm with 8 layers of 35 μm copper.

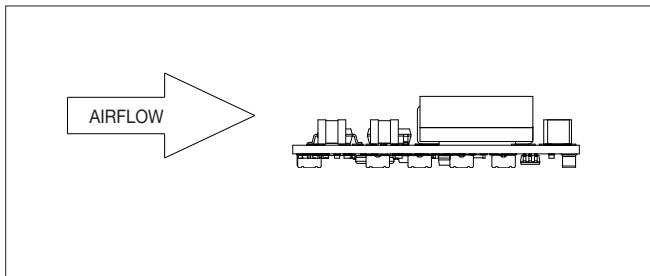

### Calculation of ambient temperature

By using the thermal resistance the maximum allowed ambient temperature can be calculated.

A. The powerloss is calculated by using the formula  
 $((1/\eta) - 1) \times \text{output power} = \text{power losses}$ .  
 $\eta$  = efficiency of regulator. Example: 95% = 0.95

B. Find the value of the thermal resistance  $R_{th Tref-A}$  in the diagram by using the airflow speed at the module. Take the thermal resistance × powerloss to get the temperature increase.

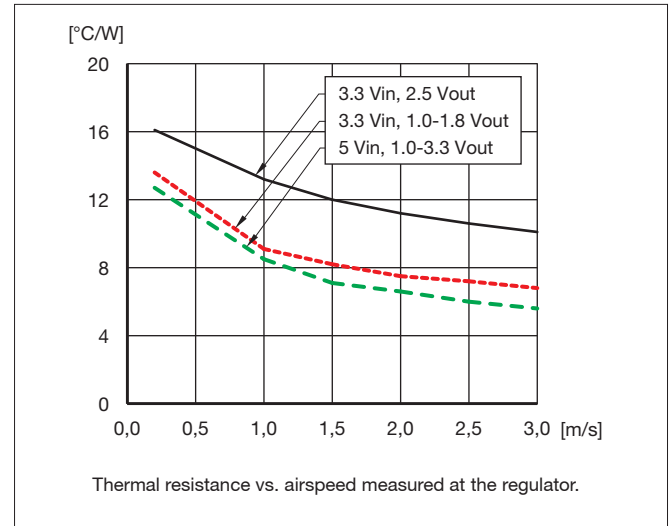

C. Max allowed calculated ambient temperature is:  
 Max  $T_{ref}$  of DC/DC regulator - temperature increase.

**Example:** 1.8 V output at 1m/s, full load, 3.3 V in:

A.  $((1/0.915) - 1) \times 18 \text{ W} = 1.67 \text{ W}$

B.  $1.67 \text{ W} \times 9 \text{ °C/W} = 15 \text{ °C}$

C.  $115 \text{ °C} - 15 \text{ °C} = \text{max ambient temperature is } 100 \text{ °C}$

The real temperature will be dependent on several factors, like PCB size and type, direction of airflow, air turbulence etc. It is recommended to verify the temperature by testing.

## Soldering Information

The PMC series DC/DC regulators are intended for reflow soldering processes. Extra precautions must be taken when reflow soldering the module. Neglecting the soldering information given below may result in permanent damage or significant degradation of the power module performance. No responsibility is assumed if these recommendations are not strictly followed.

The module can be reflow soldered using vapour phase reflow (VPR) or forced convection reflow.

To ensure proper soldering of the regulators the temperature should be monitored on interconnection pin GND. The interconnection GND is considered as representative due to the heavy copper path characterisation. A thermocouple can be attached to the pin GND by means of a suitable adhesive or heat conductive paste, see the mechanical data on page 4.

The reflow profile should be optimised to avoid solder paste drying and overheating of the module. Most important is to ensure that the interconnection pins on the coldest area reach sufficient soldering temperature for sufficiently long time. A sufficiently extended soak time is recommended to ensure an even temperature throughout the PCB, for both small and large components. To reduce the risk of overheating the power module, it is also recommended to minimise the time in reflow as much as possible.

## High temperature solders - Reflow profile

Ramp up, ramp-down rate			
Pre-heat	Soak zone	Reflow zone	Cooling
max 3°C/s	max 0.5°C/s	max 3°C/s	max 4°C/s
Temperature interval, time			
	Soak zone	Reflow zone	
	150-200°C, 60-180 s	Above 220°C, 30-80 s	
Peak temperature, time			
		Reflow zone	
		235-245°C, 10-30 s	

For lead free solder processes (solder melting point 217°C), the PMC series is qualified for MSL 1 according to JEDEC standard "J-STD-020c". During reflow, the module temperature must not exceed +245 °C at any time.

## Low temperature solder - reflow profile

Ramp up, ramp-down rate			
Pre-heat	Soak zone	Reflow zone	Cooling
max 3°C/s	max 0.5°C/s	max 3°C/s	max 4°C/s
Temperature interval, time			
	Soak zone	Reflow zone	
	130-170°C, 60-120 s	Above 183°C, 30-80 s	
Peak temperature, time			
		Reflow zone	
		210-225°C, 10-30 s	

For conventional Sn-Pb solder processes (solder melting point 179°C -183°C), The PMC series is qualified for MSL 1 according to JEDEC standard "J-STD-020c". During reflow, the module temperature must not exceed +225 °C at any time.

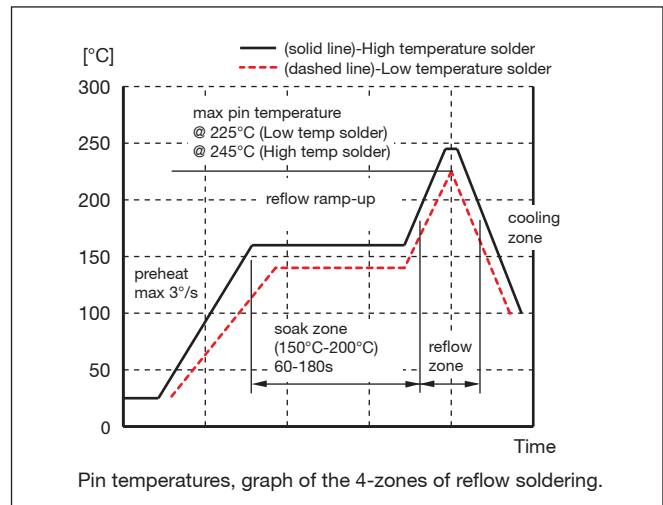

## Delivery Package Information

The PMC 4000 series regulators are delivered in antistatic tape & reel (EIA standards 481-2).

Tape & reel specification:

Material:	Conductive
Tape width:	44 mm [1.73 in.]
Tape pitch:	24 mm [0.95 in.]
Total pocket height:	9.1 mm [0.36 in.]
Reel diameter:	330 mm [13 in.]
Reel capacity:	200 pieces
Full reel weight:	typ. 2.0 kg

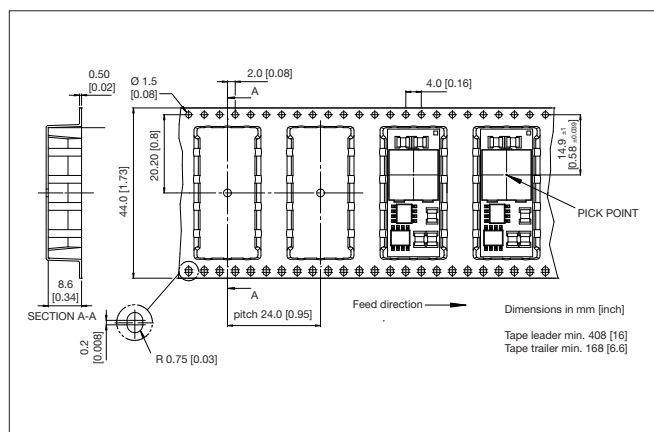

## Reliability

The Mean Time Between Failure (MTBF) of the PMC 4000 series DC/DC regulator family is calculated to be greater than 6 million hours at full output power and a reference temperature of +40 °C using TelCordia SR 332.

## Compatibility with RoHS requirements

The products are compatible with the relevant clauses and requirements of the RoHS directive 2002/95/EC and have a maximum concentration value of 0.1% by weight in homogeneous materials for lead, mercury, hexavalent chromium, PBB and PBDE and of 0.01% by weight in homogeneous materials for cadmium.

Exemptions in the RoHS directive utilized in Ericsson Power Modules products include:

- Lead in high melting temperature type solder (used to solder the die in semiconductor packages)
- Lead in glass of electronics components and in electronic ceramic parts (e.g. fill material in chip resistors)
- Lead as an alloying element in copper alloy containing up to 4% lead by weight (used in connection pins made of Brass)

## Sales Offices and Contact Information

Company Headquarters  
Ericsson Power Modules AB  
LM Ericssons väg 30  
SE-126 25 Stockholm  
Sweden

Phone: +46-8-568-69620  
Fax: +46-8-568-69599

China  
Ericsson Simtek Electronics Co.  
33 Fuhua Road  
Jiading District  
Shanghai 201 818  
China

Phone: +86-21-5990-3258  
Fax: +86-21-5990-0188

Germany, Austria  
Ericsson Power Modules AB  
Mühlhauser Weg 18  
85737 Ismaning  
Germany

Phone: +49-89-9500-6905  
Fax: +49-89-9500-6911

Hong Kong (Asia Pacific)  
Ericsson Ltd.  
12/F. Devon House  
979 King's Road  
Quarry Bay  
Hong Kong

Phone: +852-2590-2453  
Fax: +852-2590-7152

Italy, Spain (Mediterranean)  
Ericsson Power Modules AB  
Via Cadorna 71  
20090 Vimodrone (MI)  
Italy

Phone: +39-02-265-946-07  
Fax: +39-02-265-946-69

Japan  
Ericsson Power Modules AB  
Kimura Daini Building, 3 FL.  
3-29-7 Minami-Oomachi, Shinagawa-ka  
Tokyo 140-0013  
Japan

Phone: +81-3-5733-5107  
Fax: +81-3-5753-5162

North and South America  
Ericsson Inc. Power Modules  
6300 Legacy Dr.  
Plano, TX 75024  
USA

Phone: +1-972-583-5254  
+1-972-583-6910  
Fax: +1-972-583-7839

All other countries  
Contact Company Headquarters  
or visit our website:  
[www.ericsson.com/powermodules](http://www.ericsson.com/powermodules)

Information given in this data sheet is believed to be accurate and reliable.  
No responsibility is assumed for the consequences of its use nor for any infringement of patents or other rights of third parties which may result from its use.  
No license is granted by implication or otherwise under any patent or patent rights of Ericsson Power Modules. These products are sold only according to Ericsson Power Modules' general conditions of sale, unless otherwise confirmed in writing. Specifications subject to change without notice.

## X-ON Electronics

Largest Supplier of Electrical and Electronic Components

*Click to view similar products for [Non-Isolated DC/DC Converters](#) category:*

*Click to view products by [Ericsson](#) manufacturer:*

Other Similar products are found below :

[PSR152.5-7IR](#) [APTH003A0X-SRZ](#) [SPM1004-3V3C](#) [R-785.0-05](#) [10E24-P15-10PPM](#) [1E24-P4-25PPM-SHV-5KV](#) [CA-17205-L4](#)  
[PROPOWER-3.3V](#) [MYGTM01210BZN](#) [JRCS016A0S4-HZ](#) [3V12-N0.8](#) [6AA24-P30-I5-M](#) [BM2P101X-Z](#) [ROF-78E12-0.5SMD-R](#)  
[RPMA5.0-8.0/OF](#) [PTV03010WAD](#) [PTV05020WAH](#) [PTV12010LAH](#) [PTV12020WAD](#) [R-7212D](#) [R-7212P](#) [R-78AA5.0-1.0SMD](#) [30A24-](#)  
[N15-E](#) [10A12-P4-M](#) [10C24-N250-I5](#) [10C24-P125](#) [10C24-P250-I5](#) [6A24-P20-I10-F-M-25PPM](#) [1A24-P30-F-M-C](#) [TSR 1-24150SM](#)  
[1/2AA24-N30-I10](#) [1C24-N125](#) [12C24-N250](#) [V7806-1500](#) [PTV05010WAH](#) [PTN04050CAZT](#) [PTH12020WAD](#) [PTH12020LAS](#)  
[PTH05T210WAH](#) [V7803-2000R](#) [AXA005A0XZ](#) [NSR020A0X43Z](#) [TPS82677SIPR](#) [OKR-T/30-W12-C](#) [NID30S24-15](#) [NID30S48-24](#)  
[LXDC2HL25A-053](#) [LXDC2HL10A-080](#) [PTH05T210WAD](#) [PTH08T210WAS](#)