

PMN 8000 series PoL Regulator
 Input 5.5 - 14 V, Output up to 30 A / 108 W

EN/LZT 146 387 R1B December 2009

© Ericsson AB

Key Features

- Industry standard POLA™ compatible
- 34.8 x 15.75 x 8.5 mm (1.37 x 0.62 x 0.335 in.)
- High efficiency, up to. 96%
- Auto Track™ sequencing pin
- Turbo Trans™ Technology for Ultra-Fast Transient
- More than 3.6 million hours MTBF

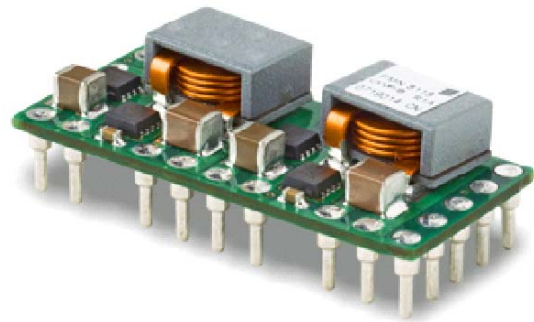

General Characteristics

- Operating temperature: -40°C to 85°C
- Input under voltage protection
- Start up into a pre-biased output
- Output short-circuit protection
- On/Off inhibit control
- Wide input voltage function
- Wide output voltage adjust function
- Highly automated manufacturing ensures quality
- ISO 9001/14001 certified supplier

Safety Approvals



Design for Environment



Meets requirements in high-temperature lead-free soldering processes.

Contents

General Information	2
Safety Specification	3
Absolute Maximum Ratings	4
Product Program	Ordering No.
0.7-3.6V, 30A / 108W	PMN 8118UW P
0.7V, 30A / 21W Electrical Specification	5
1.0V, 30A / 30W Electrical Specification	8
1.2V, 30A / 36W Electrical Specification	11
1.5V, 30A / 45W Electrical Specification	14
1.8V, 30A / 54W Electrical Specification	17
2.5V, 30A / 75W Electrical Specification	20
3.3V, 30A / 99W Electrical Specification	23
EMC Specification	26
Operating Information	26
Thermal Consideration	30
Connections	31
Mechanical Information	33
Soldering Information	35
Delivery Information	36
Product Qualification Specification	37

PMN 8000 series PoL Regulator
Input 5.5 - 14 V, Output up to 30 A / 108 W

EN/LZT 146 387 R1B December 2009

© Ericsson AB

General Information

Ordering Information

See Contents for individual product ordering numbers.

Option	Suffix	Ordering No.
SMD pin	S	PMN 8118UW S
SMD pin with lead-free surface	SR	PMN 8118UW SR

Reliability

The Mean Time Between Failure (MTBF) is calculated at full output power and an operating ambient temperature (T_A) of +40°C, which is a typical condition in Information and Communication Technology (ICT) equipment. Different methods could be used to calculate the predicted MTBF and failure rate which may give different results. Ericsson Power Modules currently uses Telcordia SR332.

Predicted MTBF for the series is:

- 3.6 million hours according to Telcordia SR332, issue 1, Black box technique.

Telcordia SR332 is a commonly used standard method intended for reliability calculations in ICT equipment. The parts count procedure used in this method was originally modelled on the methods from MIL-HDBK-217F, Reliability Predictions of Electronic Equipment. It assumes that no reliability data is available on the actual units and devices for which the predictions are to be made, i.e. all predictions are based on generic reliability parameters.

Compatibility with RoHS requirements

The products are compatible with the relevant clauses and requirements of the RoHS directive 2002/95/EC and have a maximum concentration value of 0.1% by weight in homogeneous materials for lead, mercury, hexavalent chromium, PBB and PBDE and of 0.01% by weight in homogeneous materials for cadmium.

Exemptions in the RoHS directive utilized in Ericsson Power Modules products include:

- Lead in high melting temperature type solder (used to solder the die in semiconductor packages)
- Lead in glass of electronics components and in electronic ceramic parts (e.g. fill material in chip resistors)
- Lead as an alloying element in copper alloy containing up to 4% lead by weight (used in connection pins made of Brass)

The exemption for lead in solder for servers, storage and storage array systems, network infrastructure equipment for switching, signaling, transmission as well as network management for telecommunication is only utilized in surface mount products intended for end-users' leaded SnPb Eutectic soldering processes. (See ordering information table)

Quality Statement

The products are designed and manufactured in an industrial environment where quality systems and methods like ISO 9000, 6σ (sigma), and SPC are intensively in use to boost the continuous improvements strategy. Infant mortality or early failures in the products are screened out and they are subjected to an ATE-based final test. Conservative design rules, design reviews and product qualifications, plus the high competence of an engaged work force, contribute to the high quality of our products.

Warranty

Warranty period and conditions are defined in Ericsson Power Modules General Terms and Conditions of Sale.

Limitation of Liability

Ericsson Power Modules does not make any other warranties, expressed or implied including any warranty of merchantability or fitness for a particular purpose (including, but not limited to, use in life support applications, where malfunctions of product can cause injury to a person's health or life).

PMN 8000 series PoL Regulator
Input 5.5 - 14 V, Output up to 30 A / 108 W

EN/LZT 146 387 R1B December 2009

© Ericsson AB

Safety Specification**General information**

Ericsson Power Modules DC/DC converters and DC/DC regulators are designed in accordance with safety standards IEC/EN/UL60950, *Safety of Information Technology Equipment*.

IEC/EN/UL60950 contains requirements to prevent injury or damage due to the following hazards:

- Electrical shock
- Energy hazards
- Fire
- Mechanical and heat hazards
- Radiation hazards
- Chemical hazards

On-board DC-DC converters and DC/DC regulators are defined as component power supplies. As components they cannot fully comply with the provisions of any Safety requirements without "Conditions of Acceptability". Clearance between conductors and between conductive parts of the component power supply and conductors on the board in the final product must meet the applicable Safety requirements. Certain conditions of acceptability apply for component power supplies with limited stand-off (see Mechanical Information for further information). It is the responsibility of the installer to ensure that the final product housing these components complies with the requirements of all applicable Safety standards and Directives for the final product.

Component power supplies for general use should comply with the requirements in IEC60950, EN60950 and UL60950 *"Safety of information technology equipment"*.

There are other more product related standards, e.g. IEEE802.3af "Ethernet LAN/MAN Data terminal equipment power", and ETS300132-2 "Power supply interface at the input to telecommunications equipment; part 2: DC", but all of these standards are based on IEC/EN/UL60950 with regards to safety.

Ericsson Power Modules DC/DC converters and DC/DC regulators are UL60950 recognized and certified in accordance with EN60950.

The flammability rating for all construction parts of the products meets requirements for V-0 class material according to IEC 60695-11-10.

The products should be installed in the end-use equipment, in accordance with the requirements of the ultimate application. Normally the output of the DC/DC converter is considered as SELV (Safety Extra Low Voltage) and the input source must be isolated by minimum Double or Reinforced Insulation from the primary circuit (AC mains) in accordance with IEC/EN/UL60950.

Isolated DC/DC converters

It is recommended that a slow blow fuse with a rating twice the maximum input current per selected product be used at the input of each DC/DC converter. If an input filter is used in the circuit the fuse should be placed in front of the input filter.

In the rare event of a component problem in the input filter or in the DC/DC converter that imposes a short circuit on the input source, this fuse will provide the following functions:

- Isolate the faulty DC/DC converter from the input power source so as not to affect the operation of other parts of the system.
- Protect the distribution wiring from excessive current and power loss thus preventing hazardous overheating.

The galvanic isolation is verified in an electric strength test.

The test voltage (V_{iso}) between input and output is 1500 Vdc or 2250 Vdc for 60 seconds (refer to product specification). Leakage current is less than 1 μ A at nominal input voltage.

24 V DC systems

The input voltage to the DC/DC converter is SELV (Safety Extra Low Voltage) and the output remains SELV under normal and abnormal operating conditions.

48 and 60 V DC systems

If the input voltage to the DC/DC converter is 75 Vdc or less, then the output remains SELV (Safety Extra Low Voltage) under normal and abnormal operating conditions.

Single fault testing in the input power supply circuit should be performed with the DC/DC converter connected to demonstrate that the input voltage does not exceed 75 Vdc.

If the input power source circuit is a DC power system, the source may be treated as a TNV2 circuit and testing has demonstrated compliance with SELV limits and isolation requirements equivalent to Basic Insulation in accordance with IEC/EN/UL60950.

Non-isolated DC/DC regulators

The input voltage to the DC/DC regulator is SELV (Safety Extra Low Voltage) and the output remains SELV under normal and abnormal operating conditions.

PMN 8000 series PoL Regulator
 Input 5.5 - 14 V, Output up to 30 A / 108 W

EN/LZT 146 387 R1B December 2009

© Ericsson AB

Absolute Maximum Ratings

Characteristics		min	typ	max	Unit
T_{ref}	Operating Temperature (see Thermal Consideration section)	-40		85	°C
T_S	Storage temperature	-40		125	°C
V_I	Input voltage	5.5	12	14	V
V_{RC}	Remote Control pin voltage (see Operating Information section)	Positive logic option	$V_{in}-0.5$	Open	V
		Negative logic option	N/A	N/A	V
V_{Adj}	Adjust pin voltage (see Operating Information section)	N/A		N/A	V

Stress in excess of Absolute Maximum Ratings may cause permanent damage. Absolute Maximum Ratings, sometimes referred to as no destruction limits, are normally tested with one parameter at a time exceeding the limits of Output data or Electrical Characteristics. If exposed to stress above these limits, function and performance may degrade in an unspecified manner.

Fundamental Circuit Diagram

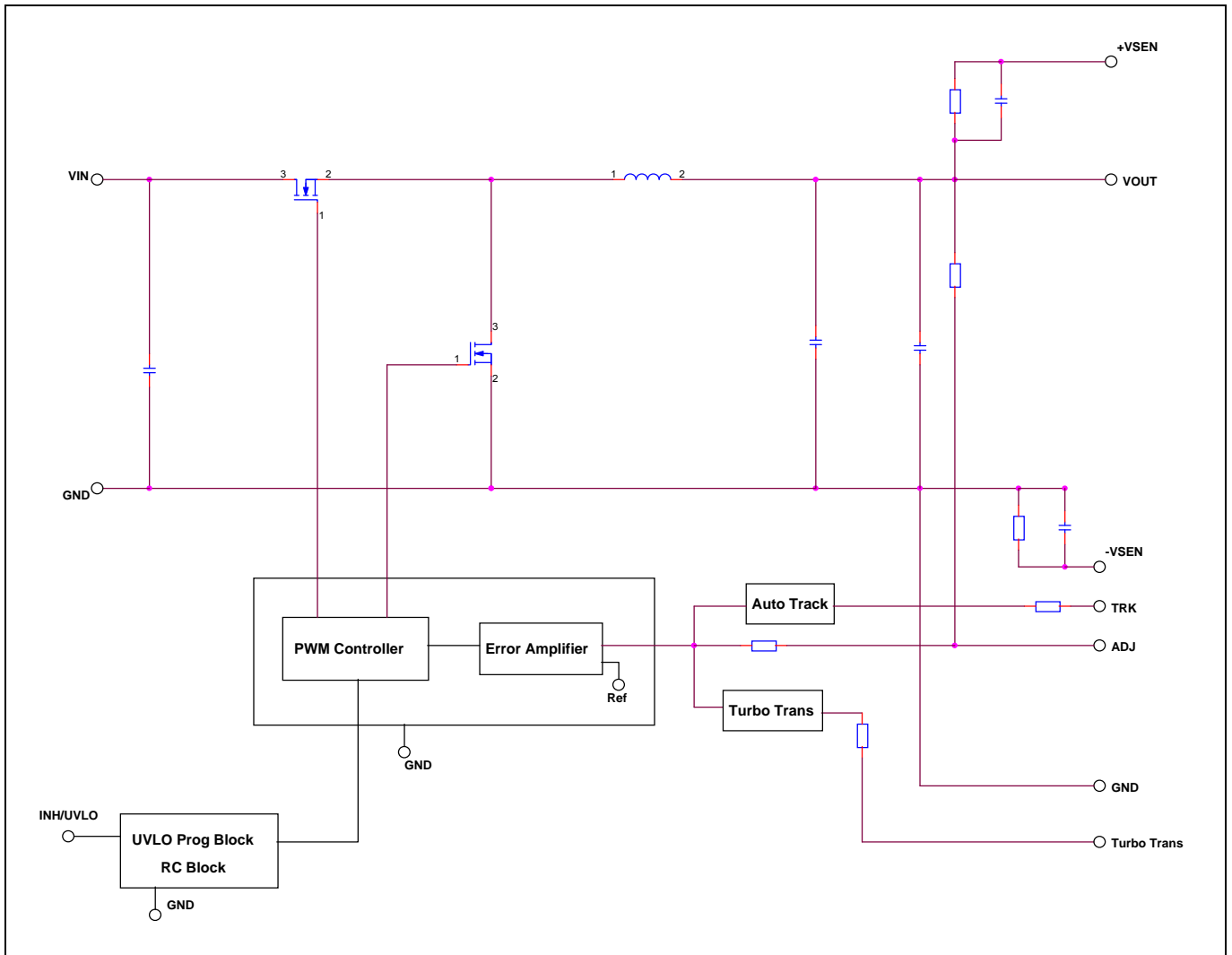

PMN 8000 series PoL Regulator
Input 5.5 - 14 V, Output up to 30 A / 108 W

EN/LZT 146 387 R1B December 2009

© Ericsson AB

0.7V, 30A / 21W Electrical Specification

PMN 8118UW P

$T_{ref} = -40$ to $+85^{\circ}\text{C}$, $V_I = 5.5$ to 14 V, $R_{adj} = \text{OPEN}$, unless otherwise specified under Conditions.

Typical values given at: $T_{ref} = +25^{\circ}\text{C}$, $V_I = 12$ V, max I_O , unless otherwise specified under Conditions.

Additional $C_{in} = 470$ μF and $C_{out} = 470$ μF . See Operating Information section for selection of capacitor types.

Connect the sense pin, where available, to the output pin.

Characteristics		Conditions	min	typ	max	Unit
V_I	Input voltage range		5.5	12	14	V
V_{loff}	Turn-off input voltage	Decreasing input voltage	3.9	4.2		V
V_{lon}	Turn-on input voltage	Increasing input voltage		5.1	5.3	V
C_I	Internal input capacitance			44		μF
P_O	Output power		0		21	W
η	Efficiency	50 % of max I_O		84.7		%
		max I_O		79.3		
P_d	Power Dissipation	max I_O		5.5	6	W
P_{ii}	Input idling power	$I_O = 0$ A, $V_I = 12$ V		0.5		W
P_{RC}	Input standby power	$V_I = 12$ V (turned off with RC)		33.9		mW
I_S	Static Input current	$V_I = 12$ V, max I_O		2.2		A
f_s	Switching frequency	0-100 % of max I_O	430	480	530	kHz

V_{Oi}	Output voltage initial setting and accuracy	$T_{ref} = +25^{\circ}\text{C}$, $V_I = 12$ V, max I_O	0.689	0.700	0.711	V
V_O	Output voltage tolerance band	10-100 % of max I_O	0.679		0.721	V
	Idling voltage	$I_O = 0$ A		0.703		V
	Line regulation	max I_O		± 4		mV
	Load regulation	$V_I = 12$ V, 0-100 % of max I_O		± 7		mV
V_{tr}	Load transient voltage deviation	$V_I = 12$ V, Load step 25-75-25 % of max I_O , $di/dt = 2.5$ A/ μs		± 130		mV
t_{tr}	Load transient recovery time	Without Turbo Trans $C_o = 1000$ μF Type A		50		μs
V_{tr}	Load transient voltage deviation	$V_I = 12$ V, Load step 25-75-25 % of max I_O , $di/dt = 2.5$ A/ μs		± 95		mV
t_{tr}	Load transient recovery time	With Turbo Trans $C_o = 1000$ μF Type A; $R_{TT} = 20$ k Ω		40		μs
t_r	Ramp-up time (from 10–90 % of V_{Oj})	100 % of max I_O		9.9		ms
t_s	Start-up time (from V_I connection to 90 % of V_{Oj})			16.8		ms
t_f	V_I shut-down fall time. (From V_I off to 10 % of V_O)	Max I_O		1.4		ms
		$I_O = 0.1$ A		93.6		ms
$t_{RC} t_{inh}$	RC start-up time	Max I_O		15.9		ms
	RC shut-down fall time	Max I_O		0.2		ms

PMN 8000 series PoL Regulator
 Input 5.5 - 14 V, Output up to 30 A / 108 W

EN/LZT 146 387 R1B December 2009

© Ericsson AB

0.7V, 30A / 21W Typical Characteristics

PMN 8118UW P

Efficiency

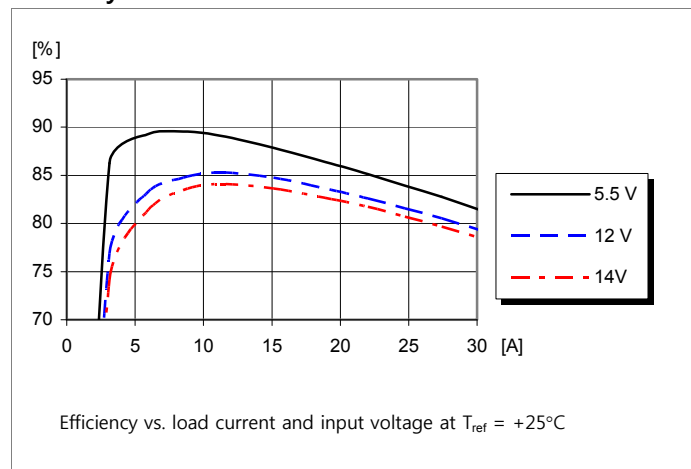

Power Dissipation

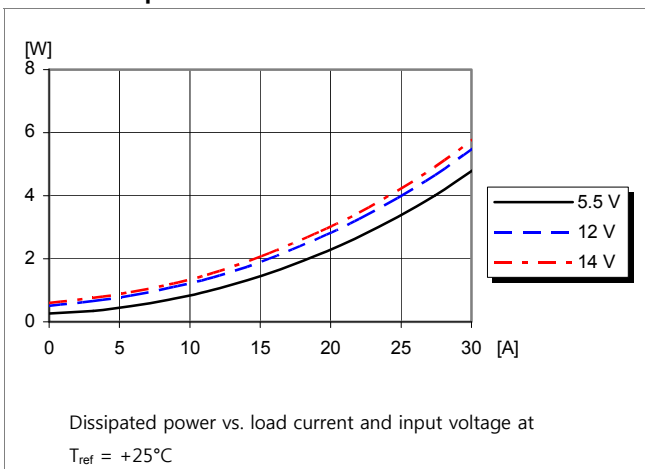

Output Current Derating

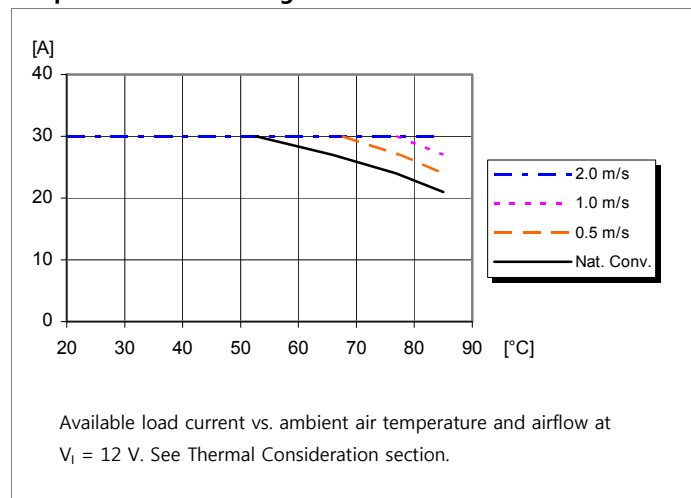

Thermal Resistance

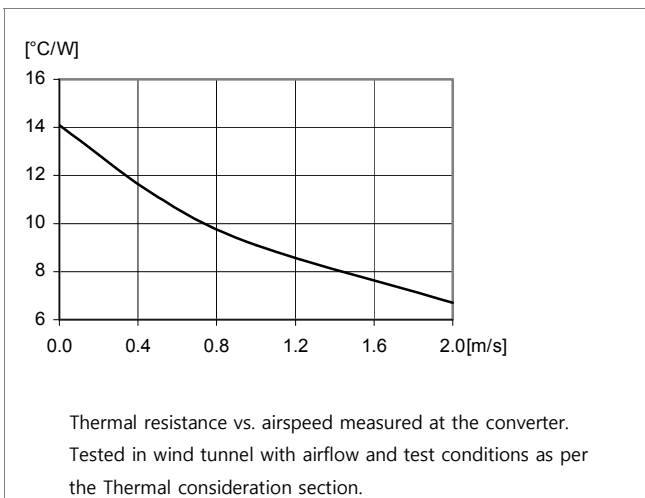

Output Characteristics

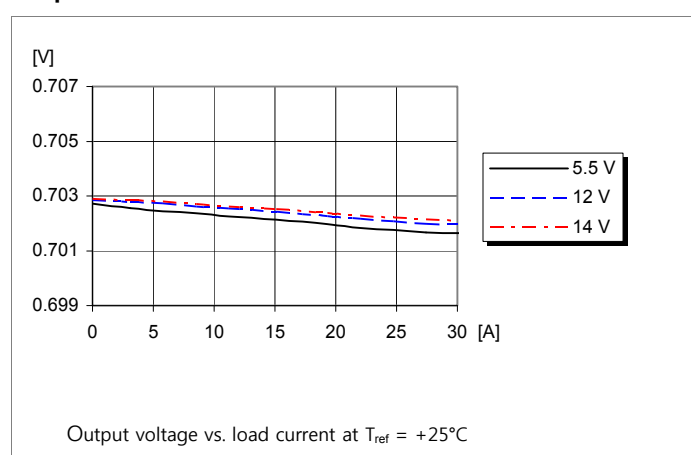

Current Limit Characteristics

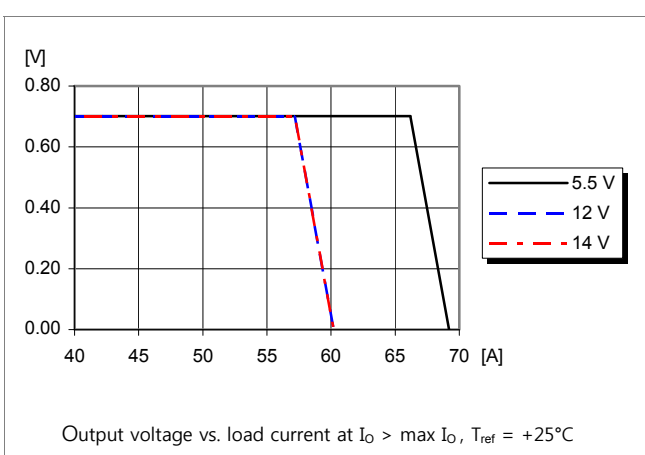

PMN 8000 series PoL Regulator
 Input 5.5 - 14 V, Output up to 30 A / 108 W

EN/LZT 146 387 R1B December 2009

© Ericsson AB

0.7V, 30A / 21W Typical Characteristics

PMN 8118UW P

Start-up

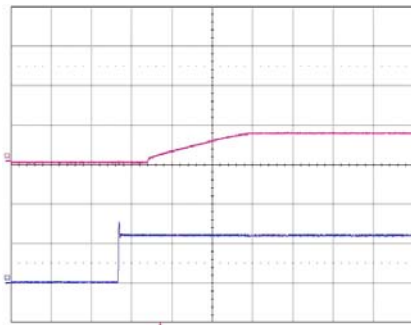

Start-up enabled by connecting V_I at: $T_{ref} = +25^\circ\text{C}$, $V_I = 12\text{ V}$,
 Top trace: output voltage (1 V/div).
 Bottom trace: input voltage (10 V/div).

Shut-down

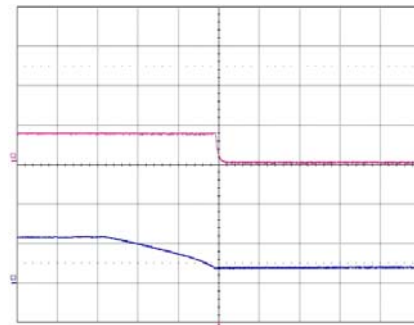

Shut-down enabled by disconnecting V_I at: $T_{ref} = +25^\circ\text{C}$, $V_I = 12\text{ V}$,
 Top trace: output voltage (1 V/div).
 Bottom trace: input voltage (10 V/div).

Output Ripple & Noise

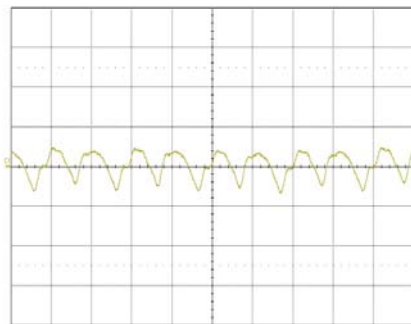

Output voltage ripple at: $T_{ref} = +25^\circ\text{C}$, $V_I = 12\text{ V}$,
 $I_O = 30\text{ A}$ resistive load.
 Trace: output voltage (5 mV/div).
 Time scale: (2 μs /div).

Output Load Transient Response

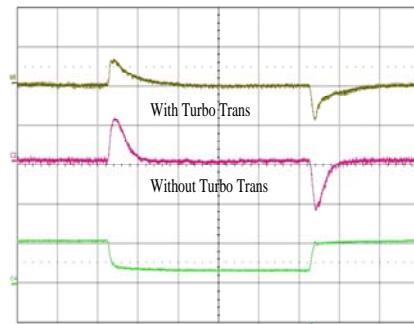

Output voltage response to load current step-change (7.5-22.5-7.5 A) at: $T_{ref} = +25^\circ\text{C}$, $V_I = 12\text{ V}$.
 Top trace: output voltage (100 mV/div).
 Middle Trace: output voltage (100mV/div).
 Bottom trace: load current (20 A/div).

Output Voltage Adjust (see operating information)

Passive adjust

The resistor value for an adjusted output voltage is calculated by using the equations in the operating information.

$$R_{SET} = 30.1\text{ k}\Omega \times \frac{0.7}{V_o - 0.7} - 6.49\text{ k}\Omega$$

PMN 8000 series PoL Regulator
Input 5.5 - 14 V, Output up to 30 A / 108 W

EN/LZT 146 387 R1B December 2009

© Ericsson AB

1.0V, 30A / 30W Electrical Specification

PMN 8118UW P

$T_{ref} = -40$ to $+85^{\circ}\text{C}$, $V_I = 5.5$ to 14 V, $R_{adj} = 63.4$ k Ω , unless otherwise specified under Conditions.

Typical values given at: $T_{ref} = +25^{\circ}\text{C}$, $V_I = 12$ V, max I_O , unless otherwise specified under Conditions.

Additional $C_{in} = 470$ μF and $C_{out} = 470$ μF . See Operating Information section for selection of capacitor types.

Connect the sense pin, where available, to the output pin.

Characteristics		Conditions	min	typ	max	Unit
V_I	Input voltage range		5.5	12	14	V
V_{loff}	Turn-off input voltage	Decreasing input voltage	3.9	4.2		V
V_{lon}	Turn-on input voltage	Increasing input voltage		5.1	5.3	V
C_I	Internal input capacitance			44		μF
P_O	Output power		0		30	W
η	Efficiency	50 % of max I_O		87.7		%
		max I_O		83.9		
P_d	Power Dissipation	max I_O		5.8	6.3	W
P_{li}	Input idling power	$I_O = 0$ A, $V_I = 12$ V		0.67		W
P_{RC}	Input standby power	$V_I = 12$ V (turned off with RC)		30.2		mW
I_S	Static Input current	$V_I = 12$ V, max I_O		3.0		A
f_s	Switching frequency	0-100 % of max I_O	430	480	530	kHz

V_{oi}	Output voltage initial setting and accuracy	$T_{ref} = +25^{\circ}\text{C}$, $V_I = 12$ V, max I_O	0.985	1.000	1.015	V
V_O	Output voltage tolerance band	10-100 % of max I_O	0.970		1.030	V
	Idling voltage	$I_O = 0$ A		1.006		V
	Line regulation	max I_O		± 4		mV
	Load regulation	$V_I = 12$ V, 0-100 % of max I_O		± 7		mV
V_{tr}	Load transient voltage deviation	$V_I = 12$ V, Load step 25-75-25 % of max I_O , $di/dt = 2.5$ A/ μs		± 130		mV
t_{tr}	Load transient recovery time	Without Turbo Trans $C_o = 1000$ μF Type A		50		μs
V_{tr}	Load transient voltage deviation	$V_I = 12$ V, Load step 25-75-25 % of max I_O , $di/dt = 2.5$ A/ μs		± 90		mV
t_{tr}	Load transient recovery time	With Turbo Trans $C_o = 1000$ μF Type A; $R_{TT} = 20$ k Ω		40		μs
t_r	Ramp-up time (from 10–90 % of V_{oi})	100 % of max I_O		9.5		ms
t_s	Start-up time (from V_I connection to 90 % of V_{oi})			15.0		ms
t_f	V_I shut-down fall time. (From V_I off to 10 % of V_O)	Max I_O		1.1		ms
		$I_O = 0.1$ A		73.1		ms
$t_{RC} t_{inh}$	RC start-up time	Max I_O		16.0		ms

PMN 8000 series PoL Regulator
 Input 5.5 - 14 V, Output up to 30 A / 108 W

EN/LZT 146 387 R1B December 2009

© Ericsson AB

	RC shut-down fall time (From RC off to 10 % of V _O)	Max I _O	0.2	ms
		I _o = 0.1 A	0.3	ms
I _O	Output current		0 30	A
I _{lim}	Current limit threshold	T _{ref} < max T _{ref}	58	A
I _{sc}	Short circuit current	T _{ref} = 25°C,	58	A
V _{Oac}	Output ripple & noise	See ripple & noise section, max I _O	7.8	mVp-p

PMN 8000 series PoL Regulator
 Input 5.5 - 14 V, Output up to 30 A / 108 W

EN/LZT 146 387 R1B December 2009

© Ericsson AB

PMN 8118UW P

1.0V, 30A / 30W Typical Characteristics

Efficiency

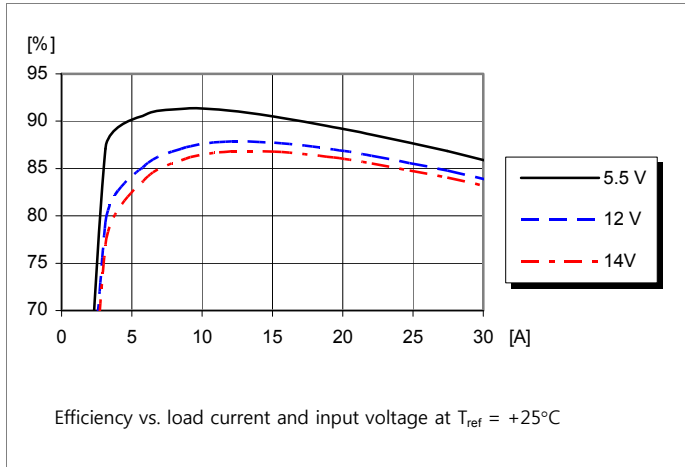

Power Dissipation

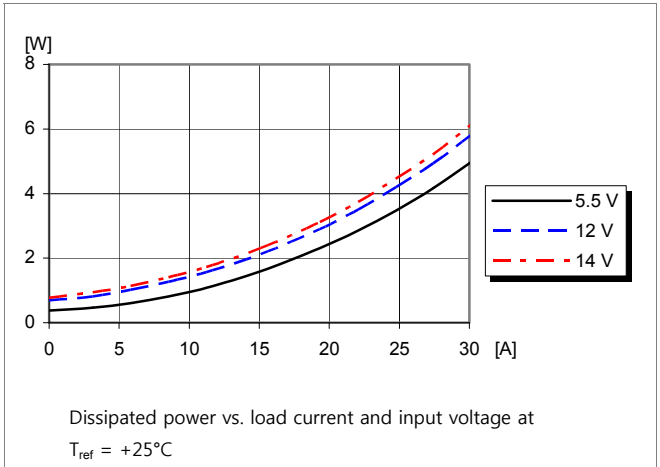

Output Current Derating

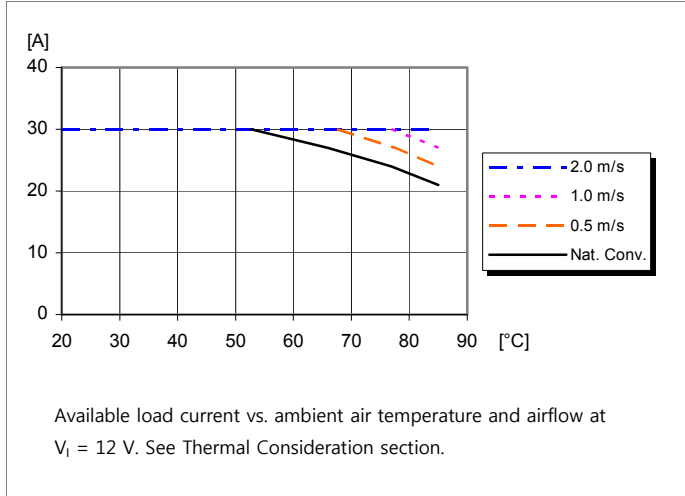

Thermal Resistance

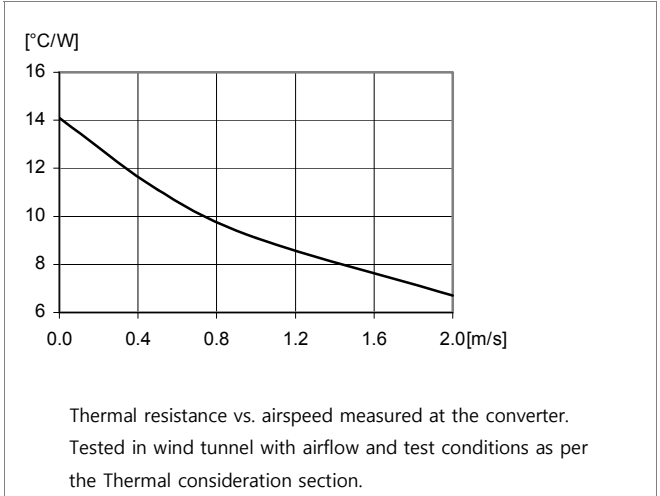

Output Characteristics

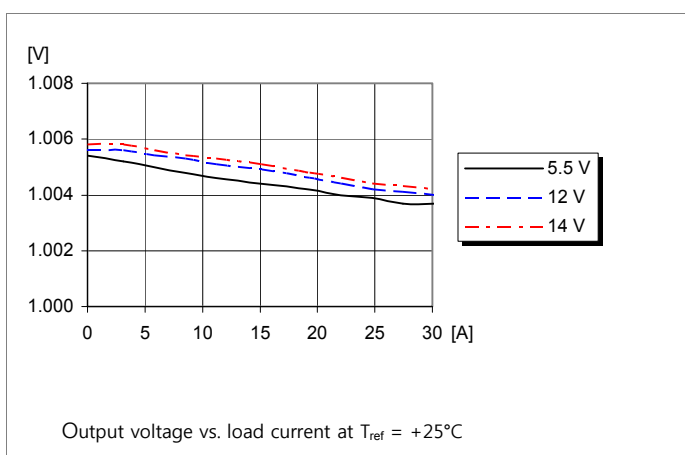

Current Limit Characteristics

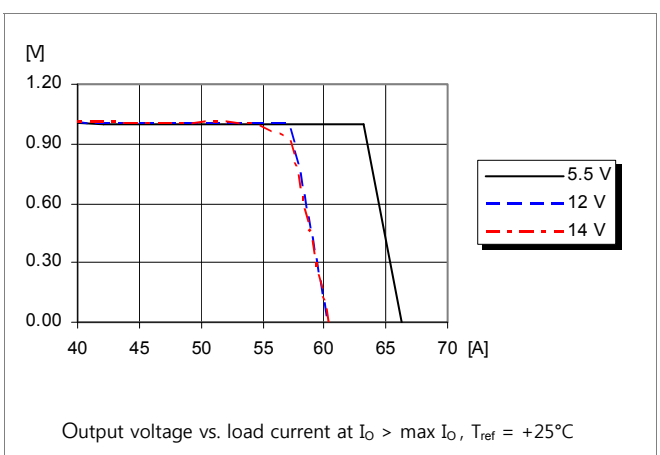

PMN 8000 series PoL Regulator
 Input 5.5 - 14 V, Output up to 30 A / 108 W

EN/LZT 146 387 R1B December 2009

© Ericsson AB

1.0V, 30A / 30W Typical Characteristics

PMN 8118UW P

Start-up

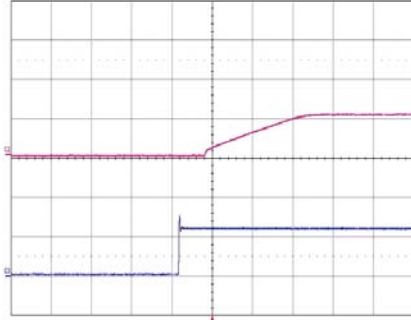

Start-up enabled by connecting V_I at: $T_{ref} = +25^\circ\text{C}$, $V_I = 12\text{ V}$,
 Top trace: output voltage (1 V/div).
 Bottom trace: input voltage (10 V/div).

Shut-down

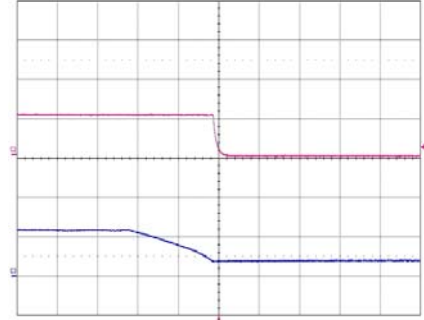

Shut-down enabled by disconnecting V_I at: $T_{ref} = +25^\circ\text{C}$, $V_I = 12\text{ V}$,
 Top trace: output voltage (1 V/div).
 Bottom trace: input voltage (10 V/div).

Output Ripple & Noise

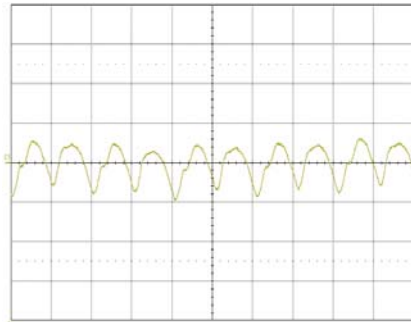

Output voltage ripple at: $T_{ref} = +25^\circ\text{C}$, $V_I = 12\text{ V}$,
 $I_O = 30\text{ A}$ resistive load.
 Trace: output voltage (5 mV/div).
 Time scale: (2 μs /div).

Output Load Transient Response

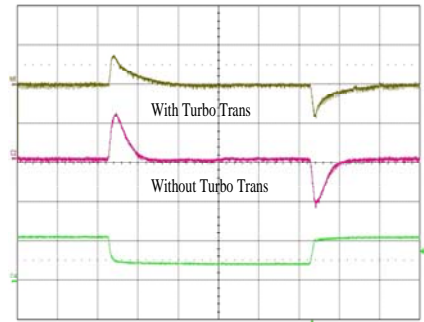

Output voltage response to load current step-change (7.5-22.5-7.5 A) at: $T_{ref} = +25^\circ\text{C}$, $V_I = 12\text{ V}$.
 Top trace: output voltage (100 mV/div).
 Middle trace: output voltage (100 mV/div).
 Bottom trace: load current (20 A/div).

Output Voltage Adjust (see operating information)

Passive adjust

The resistor value for an adjusted output voltage is calculated by using the equations in the operating information.

$$R_{SET} = 30.1\text{ k}\Omega \times \frac{0.7}{V_o - 0.7} - 6.49\text{ k}\Omega$$

PMN 8000 series PoL Regulator
 Input 5.5 - 14 V, Output up to 30 A / 108 W

EN/LZT 146 387 R1B December 2009

© Ericsson AB

1.2V, 30A / 36W Electrical Specification

PMN 8118UW P

$T_{ref} = -40$ to $+85^{\circ}\text{C}$, $V_I = 5.5$ to 14 V, $R_{adj} = 35.7$ k Ω , unless otherwise specified under Conditions.

Typical values given at: $T_{ref} = +25^{\circ}\text{C}$, $V_I = 12$ V, max I_O , unless otherwise specified under Conditions.

Additional $C_{in} = 470$ μF and $C_{out} = 470$ μF . See Operating Information section for selection of capacitor types.

Connect the sense pin, where available, to the output pin.

Characteristics		Conditions	min	typ	max	Unit
V_I	Input voltage range		5.5	12	14	V
V_{loff}	Turn-off input voltage	Decreasing input voltage	3.9	4.2		V
V_{lon}	Turn-on input voltage	Increasing input voltage		5.1	5.3	V
C_I	Internal input capacitance			44		μF
P_O	Output power		0		36	W
η	Efficiency	50 % of max I_O		88.9		%
		max I_O		85.8		
P_d	Power Dissipation	max I_O		6	6.5	W
P_{ii}	Input idling power	$I_O = 0$ A, $V_I = 12$ V		0.83		W
P_{RC}	Input standby power	$V_I = 12$ V (turned off with RC)		26.4		mW
I_S	Static Input current	$V_I = 12$ V, max I_O		3.52		A
f_s	Switching frequency	0-100 % of max I_O	430	480	530	kHz

V_{O_i}	Output voltage initial setting and accuracy	$T_{ref} = +25^{\circ}\text{C}$, $V_I = 12$ V, max I_O	1.182	1.200	1.218	V
V_O	Output voltage tolerance band	10-100 % of max I_O	1.164		1.236	V
	Idling voltage	$I_O = 0$ A		1.206		V
	Line regulation	max I_O		± 4		mV
	Load regulation	$V_I = 12$ V, 0-100 % of max I_O		± 7		mV
V_{tr}	Load transient voltage deviation	$V_I = 12$ V, Load step 25-75-25 % of max I_O , $di/dt = 2.5$ A/ μs		± 130		mV
t_{tr}	Load transient recovery time	Without Turbo Trans $C_o = 1000$ μF Type A		50		μs
V_{tr}	Load transient voltage deviation	$V_I = 12$ V, Load step 25-75-25 % of max I_O , $di/dt = 2.5$ A/ μs		± 90		mV
t_{tr}	Load transient recovery time	With Turbo Trans $C_o = 1000$ μF Type A; $R_{TT} = 20$ k Ω		50		μs
t_r	Ramp-up time (from 10–90 % of V_{O_i})	100 % of max I_O		9.2		ms
t_s	Start-up time (from V_I connection to 90 % of V_{O_i})			14.6		ms
t_f	V_I shut-down fall time. (From V_I off to 10 % of V_{O_i})	Max I_O		1.0		ms
		$I_O = 0.1$ A		67.8		ms
$t_{RC} t_{inh}$	RC start-up time	Max I_O		16.0		ms
	RC shut-down fall time	Max I_O		0.2		ms

PMN 8000 series PoL Regulator
 Input 5.5 - 14 V, Output up to 30 A / 108 W

EN/LZT 146 387 R1B December 2009

© Ericsson AB

	(From RC off to 10 % of V_o)	$I_o = 0.1 \text{ A}$	0.3	ms
I_o	Output current		0 30	A
I_{lim}	Current limit threshold	$T_{ref} < \max T_{ref}$	58	A
I_{sc}	Short circuit current	$T_{ref} = 25^\circ\text{C}$,	58	A
V_{oac}	Output ripple & noise	See ripple & noise section, max I_o	8.8	mVp-p

PMN 8000 series PoL Regulator
 Input 5.5 - 14 V, Output up to 30 A / 108 W

EN/LZT 146 387 R1B December 2009

© Ericsson AB

PMN 8118UW P

1.2V, 30A / 36W Typical Characteristics

Efficiency

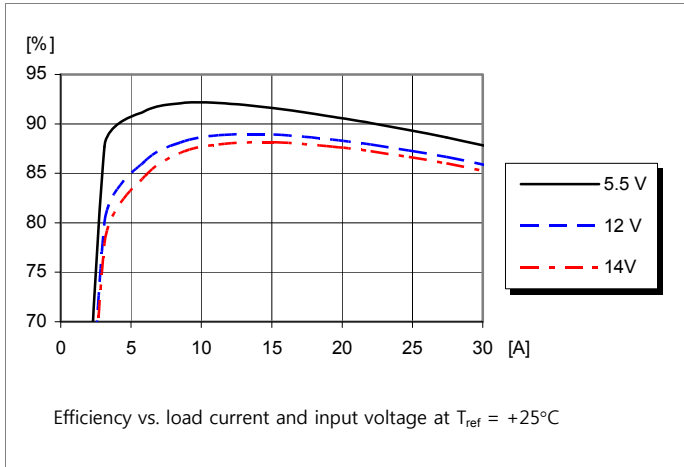

Power Dissipation

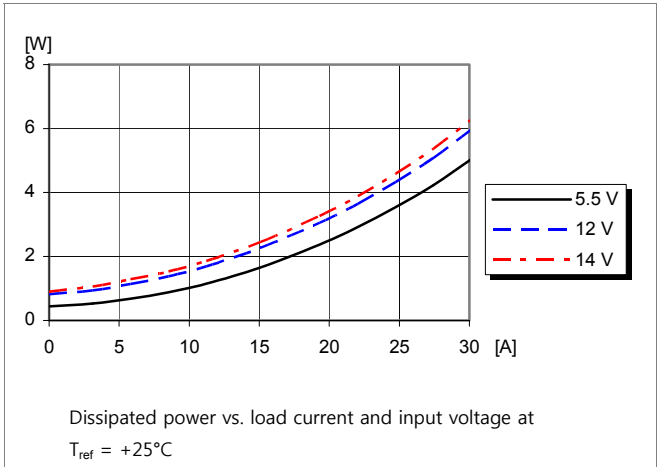

Output Current Derating

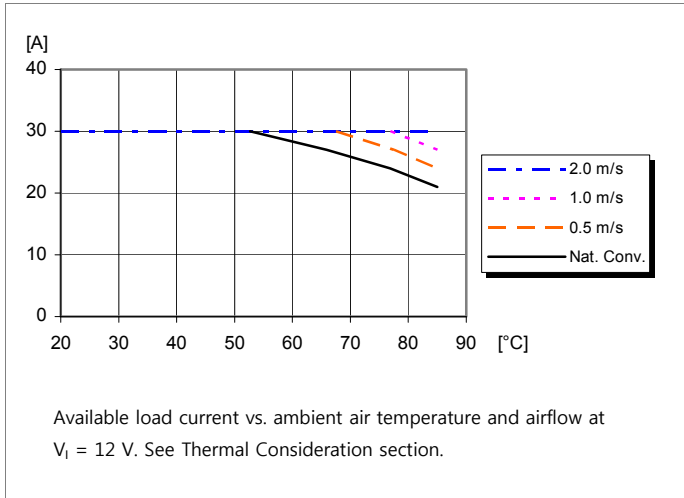

Thermal Resistance

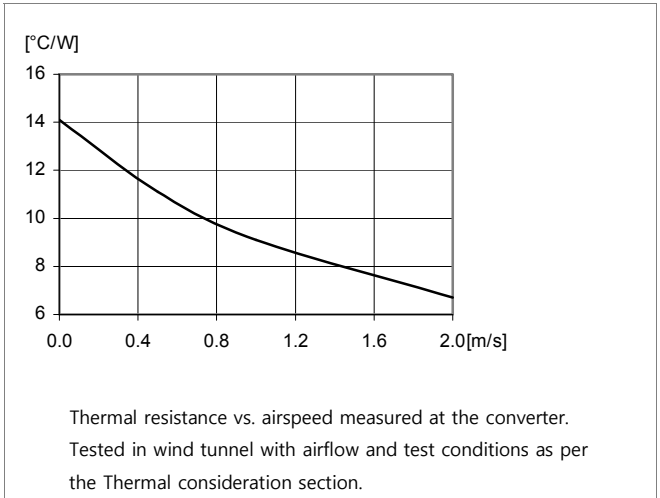

Output Characteristics

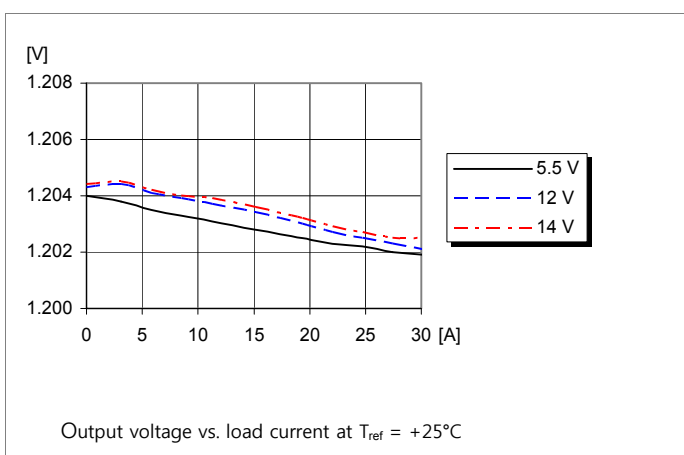

Current Limit Characteristics

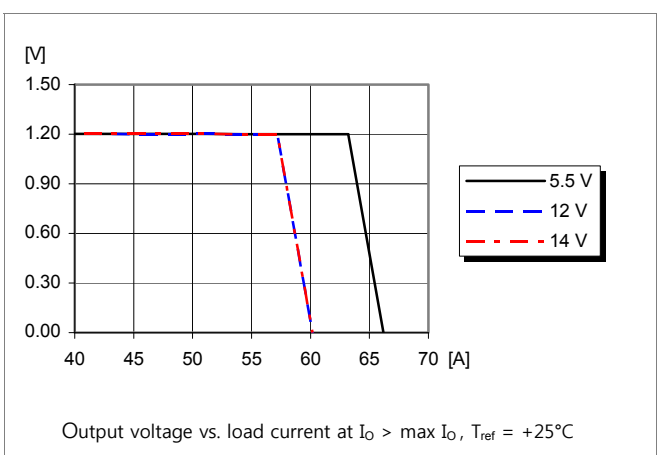

PMN 8000 series PoL Regulator
 Input 5.5 - 14 V, Output up to 30 A / 108 W

EN/LZT 146 387 R1B December 2009

© Ericsson AB

1.2V, 30A / 36W Typical Characteristics

PMN 8118UW P

Start-up

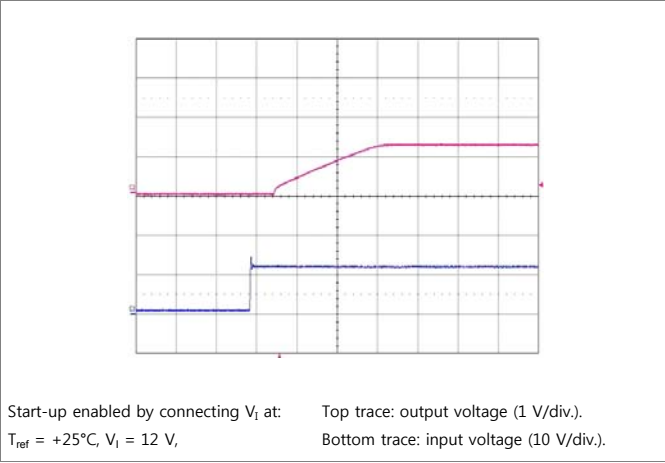

Shut-down

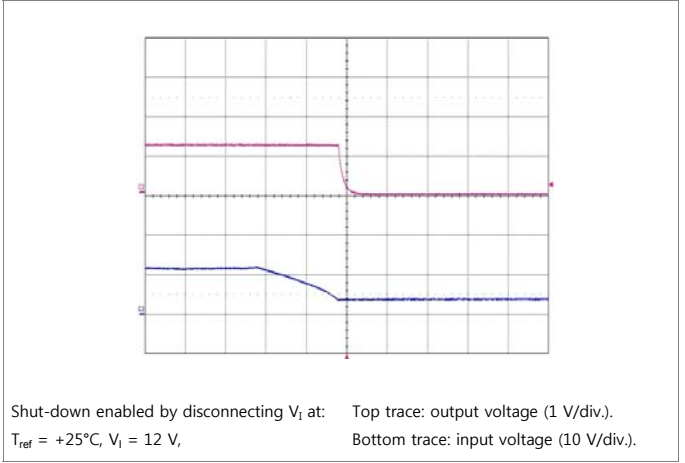

Output Ripple & Noise

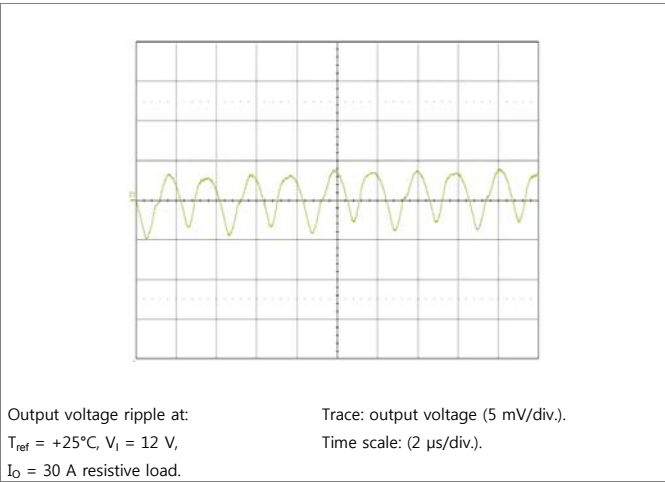

Output Load Transient Response

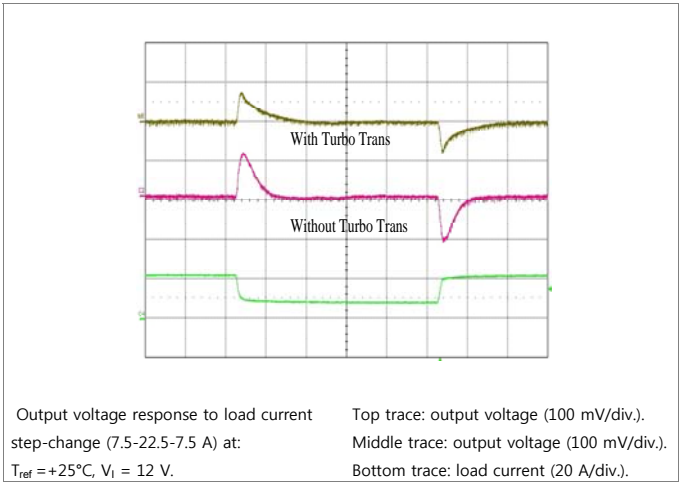

Output Voltage Adjust (see operating information)

Passive adjust

The resistor value for an adjusted output voltage is calculated by using the equations in the operating information.

$$R_{SET} = 30.1\text{ k}\Omega \times \frac{0.7}{V_o - 0.7} - 6.49\text{ k}\Omega$$

PMN 8000 series PoL Regulator
 Input 5.5 - 14 V, Output up to 30 A / 108 W

EN/LZT 146 387 R1B December 2009

© Ericsson AB

1.5V, 30A / 45W Electrical Specification

PMN 8118UW P

$T_{ref} = -40$ to $+85^{\circ}\text{C}$, $V_I = 5.5$ to 14 V, $R_{adj} = 19.6$ k Ω , unless otherwise specified under Conditions.

Typical values given at: $T_{ref} = +25^{\circ}\text{C}$, $V_I = 12$ V, max I_O , unless otherwise specified under Conditions.

Additional $C_{in} = 470$ μF and $C_{out} = 470$ μF . See Operating Information section for selection of capacitor types.

Connect the sense pin, where available, to the output pin.

Characteristics		Conditions	min	typ	max	Unit
V_I	Input voltage range		5.5	12	14	V
V_{loff}	Turn-off input voltage	Decreasing input voltage	3.9	4.2		V
V_{lon}	Turn-on input voltage	Increasing input voltage		5.1	5.3	V
C_I	Internal input capacitance			44		μF
P_O	Output power		0		45	W
η	Efficiency	50 % of max I_O		90.1		%
		max I_O		87.9		
P_d	Power Dissipation	max I_O		6.2	6.7	W
P_{ii}	Input idling power	$I_O = 0$ A, $V_I = 12$ V		1.06		W
P_{RC}	Input standby power	$V_I = 12$ V (turned off with RC)		26.4		mW
I_S	Static Input current	$V_I = 12$ V, max I_O		4.32		A
f_s	Switching frequency	0-100 % of max I_O	430	480	530	kHz

V_{Oi}	Output voltage initial setting and accuracy	$T_{ref} = +25^{\circ}\text{C}$, $V_I = 12$ V, max I_O	1.477	1.500	1.523	V
V_O	Output voltage tolerance band	10-100 % of max I_O	1.455		1.545	V
	Idling voltage	$I_O = 0$ A		1.513		V
	Line regulation	max I_O		± 4		mV
	Load regulation	$V_I = 12$ V, 0-100 % of max I_O		± 7		mV
V_{tr}	Load transient voltage deviation	$V_I = 12$ V, Load step 25-75-25 % of max I_O , $di/dt = 2.5$ A/ μs		± 130		mV
t_{tr}	Load transient recovery time	Without Turbo Trans $C_o = 1000$ μF Type A		60		μs
V_{tr}	Load transient voltage deviation	$V_I = 12$ V, Load step 25-75-25 % of max I_O , $di/dt = 2.5$ A/ μs		± 90		mV
t_{tr}	Load transient recovery time	With Turbo Trans $C_o = 1000$ μF Type A; $R_{TT} = 20$ k Ω		40		μs
t_r	Ramp-up time (from 10–90 % of V_{Oj})	100 % of max I_O		9.7		ms
t_s	Start-up time (from V_I connection to 90 % of V_{Oj})			15.4		ms
t_f	V_I shut-down fall time. (From V_I off to 10 % of V_O)	Max I_O		0.9		ms
		$I_O = 0.1$ A		61.4		ms
$t_{RC} t_{inh}$	RC start-up time	Max I_O		16.4		ms
	RC shut-down fall time	Max I_O		0.2		ms

PMN 8000 series PoL Regulator
 Input 5.5 - 14 V, Output up to 30 A / 108 W

EN/LZT 146 387 R1B December 2009

© Ericsson AB

	(From RC off to 10 % of V_o)	$I_o = 0.1 \text{ A}$	0.3	ms
I_o	Output current		0 30	A
I_{lim}	Current limit threshold	$T_{ref} < \max T_{ref}$	58	A
I_{sc}	Short circuit current	$T_{ref} = 25^\circ\text{C}$,	58	A
V_{oac}	Output ripple & noise	See ripple & noise section, $\max I_o$	9.9	mVp-p

PMN 8000 series PoL Regulator
 Input 5.5 - 14 V, Output up to 30 A / 108 W

EN/LZT 146 387 R1B December 2009

© Ericsson AB

PMN 8118UW P

1.5V, 30A / 45W Typical Characteristics

Efficiency

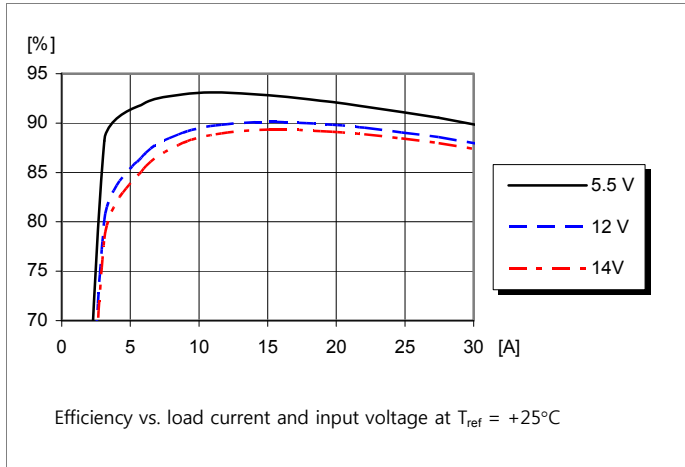

Power Dissipation

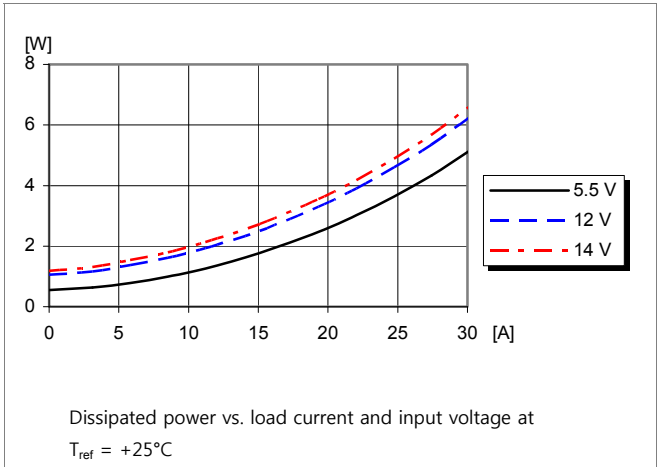

Output Current Derating

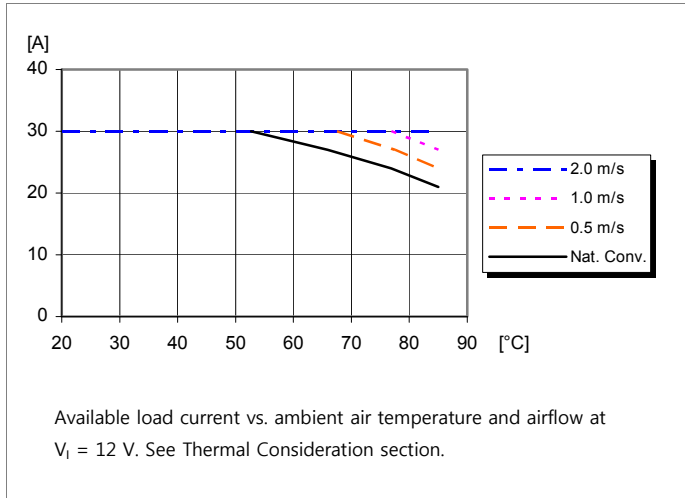

Thermal Resistance

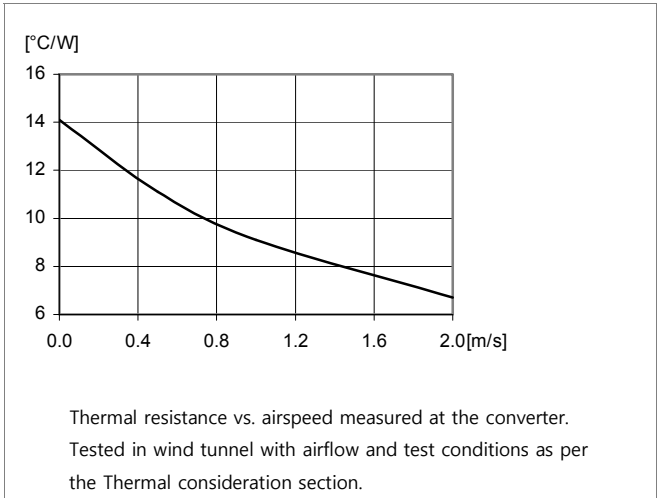

Output Characteristics

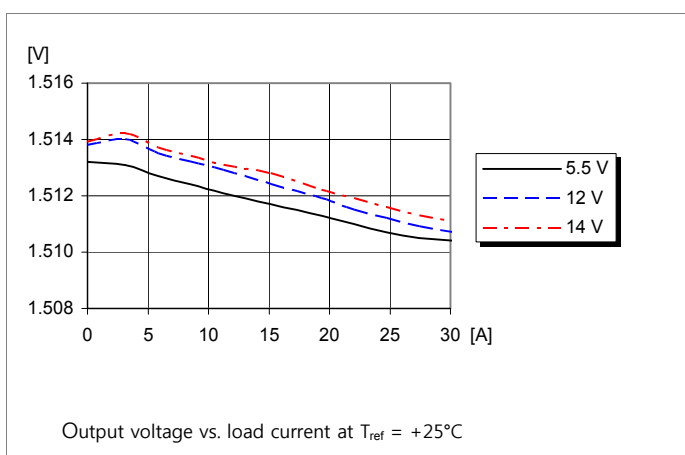

Current Limit Characteristics

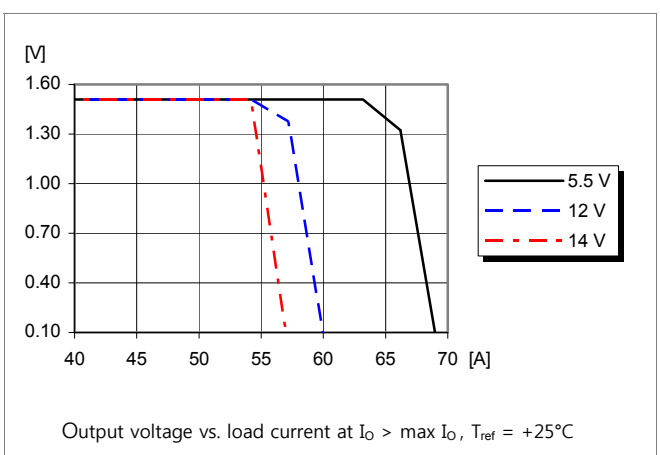

PMN 8000 series PoL Regulator
 Input 5.5 - 14 V, Output up to 30 A / 108 W

EN/LZT 146 387 R1B December 2009

© Ericsson AB

1.5V, 30A / 45W Typical Characteristics

PMN 8118UW P

Start-up

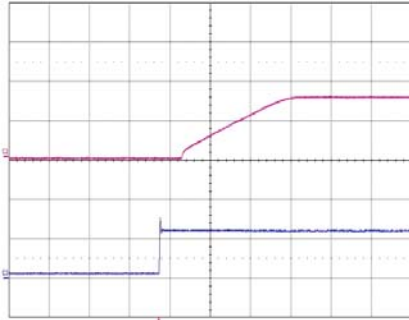

Start-up enabled by connecting V_I at: $T_{ref} = +25^\circ\text{C}$, $V_I = 12\text{ V}$,
 Top trace: output voltage (1 V/div).
 Bottom trace: input voltage (10 V/div).

Shut-down

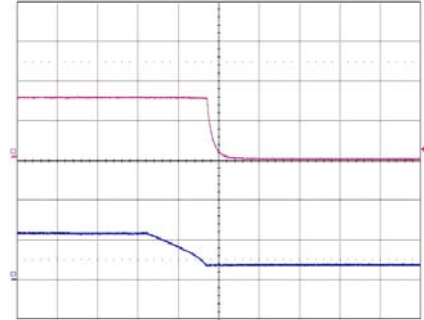

Shut-down enabled by disconnecting V_I at: $T_{ref} = +25^\circ\text{C}$, $V_I = 12\text{ V}$,
 Top trace: output voltage (1 V/div).
 Bottom trace: input voltage (10 V/div).

Output Ripple & Noise

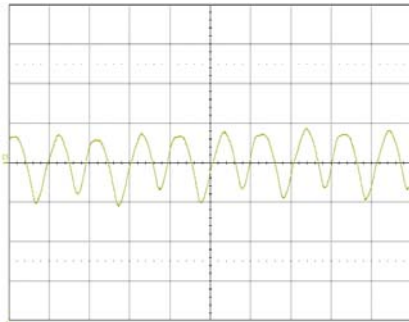

Output voltage ripple at: $T_{ref} = +25^\circ\text{C}$, $V_I = 12\text{ V}$,
 $I_O = 30\text{ A}$ resistive load.
 Trace: output voltage (5 mV/div).
 Time scale: (2 μs /div.).

Output Load Transient Response

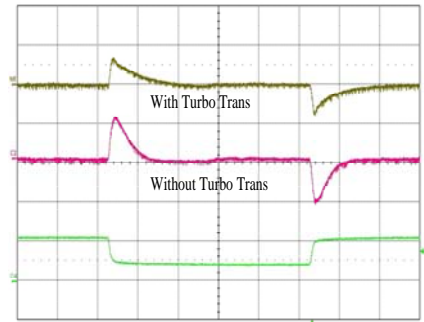

Output voltage response to load current step-change (7.5-22.5-7.5 A) at: $T_{ref} = +25^\circ\text{C}$, $V_I = 12\text{ V}$.
 Top trace: output voltage (100 mV/div).
 Middle trace: output voltage (100 mV/div).
 Bottom trace: load current (20 A/div.).

Output Voltage Adjust (see operating information)

Passive adjust

The resistor value for an adjusted output voltage is calculated by using the equations in the operating information.

$$R_{SET} = 30.1\text{ k}\Omega \times \frac{0.7}{V_o - 0.7} - 6.49\text{ k}\Omega$$

PMN 8000 series PoL Regulator
Input 5.5 - 14 V, Output up to 30 A / 108 W

EN/LZT 146 387 R1B December 2009

© Ericsson AB

1.8V, 30A / 54W Electrical Specification

PMN 8118UW P

$T_{ref} = -40$ to $+85^{\circ}C$, $V_I = 5.5$ to 14 V, $R_{adj} = 12.7$ k Ω , unless otherwise specified under Conditions.

Typical values given at: $T_{ref} = +25^{\circ}C$, $V_I = 12$ V, max I_O , unless otherwise specified under Conditions.

Additional $C_{in} = 470$ μF and $C_{out} = 470$ μF . See Operating Information section for selection of capacitor types.

Connect the sense pin, where available, to the output pin.

Characteristics		Conditions	min	typ	max	Unit
V_I	Input voltage range		5.5	12	14	V
V_{loff}	Turn-off input voltage	Decreasing input voltage	3.9	4.2		V
V_{lon}	Turn-on input voltage	Increasing input voltage		5.1	5.3	V
C_I	Internal input capacitance			44		μF
P_O	Output power		0		54	W
η	Efficiency	50 % of max I_O		90.8		%
		max I_O		89.2		
P_d	Power Dissipation	max I_O		6.5	7.0	W
P_{ii}	Input idling power	$I_O = 0$ A, $V_I = 12$ V		1.32		W
P_{RC}	Input standby power	$V_I = 12$ V (turned off with RC)		18.8		mW
I_S	Static Input current	$V_I = 12$ V, max I_O		5.00		A
f_s	Switching frequency	0-100 % of max I_O	430	480	530	kHz

V_{Oi}	Output voltage initial setting and accuracy	$T_{ref} = +25^{\circ}C$, $V_I = 12$ V, max I_O	1.773	1.800	1.827	V
V_O	Output voltage tolerance band	10-100 % of max I_O	1.746		1.854	V
	Idling voltage	$I_O = 0$ A		1.795		V
	Line regulation	max I_O		± 4		mV
	Load regulation	$V_I = 12$ V, 0-100 % of max I_O		± 7		mV
V_{tr}	Load transient voltage deviation	$V_I = 12$ V, Load step 25-75-25 % of max I_O , $di/dt = 2.5$ A/ μs		± 130		mV
t_{tr}	Load transient recovery time	Without Turbo Trans $C_o = 1000$ μF Type A		60		μs
V_{tr}	Load transient voltage deviation	$V_I = 12$ V, Load step 25-75-25 % of max I_O , $di/dt = 2.5$ A/ μs		± 90		mV
t_{tr}	Load transient recovery time	With Turbo Trans $C_o = 1000$ μF Type A; $R_{TT} = 20$ k Ω		40		μs
t_r	Ramp-up time (from 10–90 % of V_{Oi})	100 % of max I_O		10.2		ms
t_s	Start-up time (from V_I connection to 90 % of V_{Oi})			16.1		ms
t_f	V_I shut-down fall time. (From V_I off to 10 % of V_O)	Max I_O		0.9		ms
		$I_O = 0.1$ A		60.3		ms
$t_{RC} t_{inh}$	RC start-up time	Max I_O		16.5		ms
	RC shut-down fall time	Max I_O		0.3		ms

PMN 8000 series PoL Regulator
 Input 5.5 - 14 V, Output up to 30 A / 108 W

EN/LZT 146 387 R1B December 2009

© Ericsson AB

	(From RC off to 10 % of V_o)	$I_o = 0.1 \text{ A}$	0.4	ms
I_o	Output current		0 30	A
I_{lim}	Current limit threshold	$T_{ref} < \max T_{ref}$	56	A
I_{sc}	Short circuit current	$T_{ref} = 25^\circ\text{C}$,	56	A
V_{oac}	Output ripple & noise	See ripple & noise section, max I_o	11.9	mVp-p

PMN 8000 series PoL Regulator
 Input 5.5 - 14 V, Output up to 30 A / 108 W

EN/LZT 146 387 R1B December 2009

© Ericsson AB

1.8V, 30A / 54W Typical Characteristics

PMN 8118UW P

Efficiency

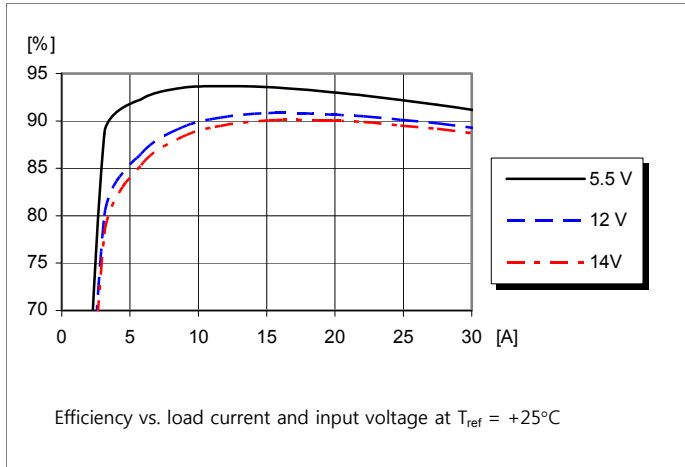

Power Dissipation

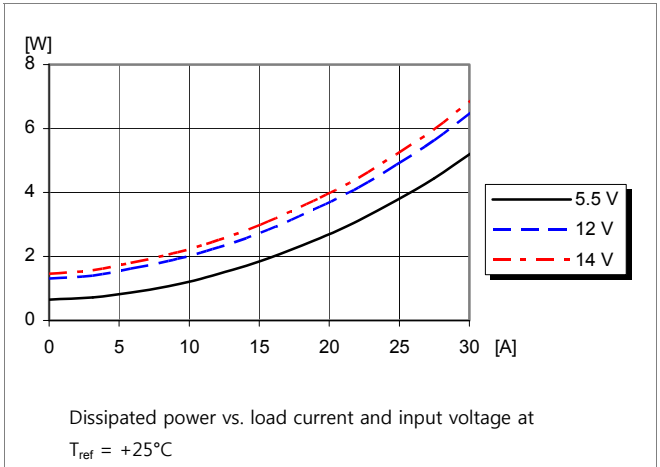

Output Current Derating

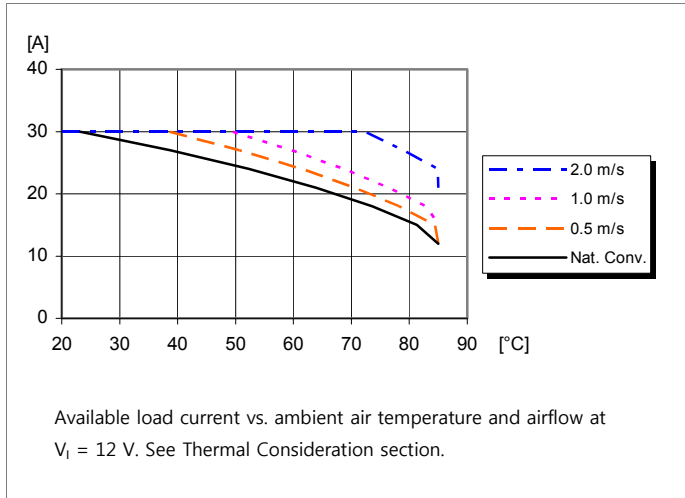

Thermal Resistance

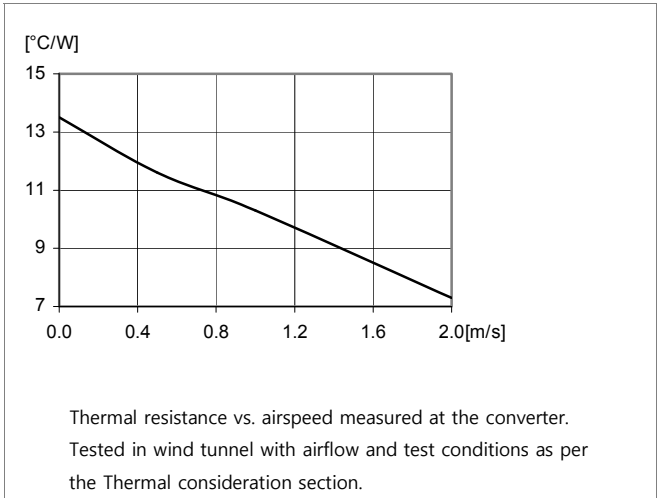

Output Characteristics

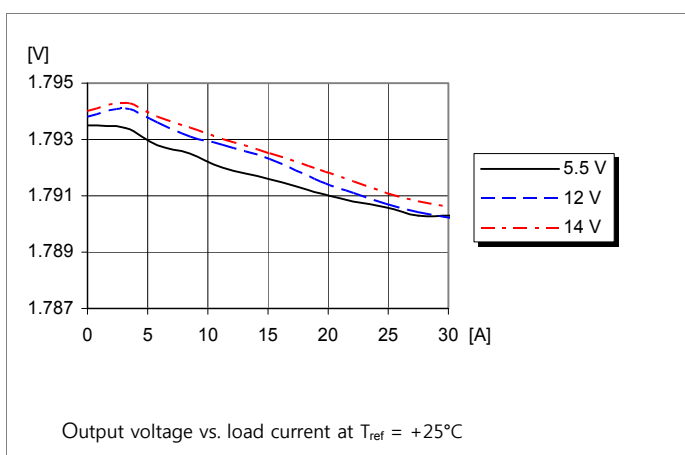

Current Limit Characteristics

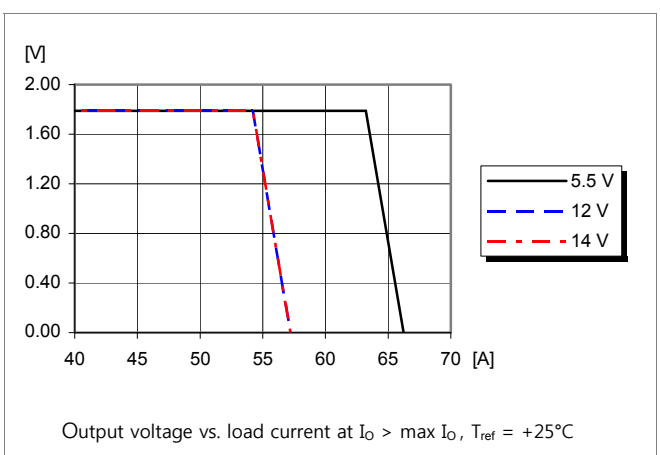

PMN 8000 series PoL Regulator
 Input 5.5 - 14 V, Output up to 30 A / 108 W

EN/LZT 146 387 R1B December 2009

© Ericsson AB

1.8V, 30A / 54W Typical Characteristics

PMN 8118UW P

Start-up

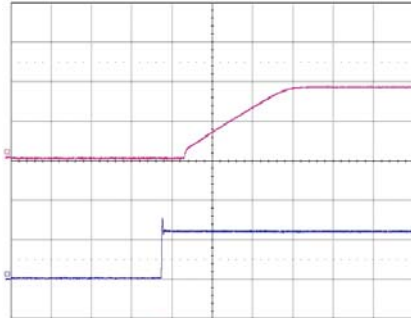

Start-up enabled by connecting V_I at: $T_{ref} = +25^\circ\text{C}$, $V_I = 12\text{ V}$,
 Top trace: output voltage (1 V/div).
 Bottom trace: input voltage (10 V/div).

Shut-down

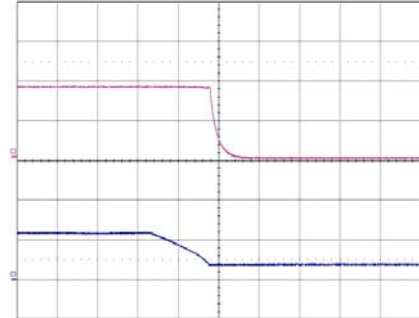

Shut-down enabled by disconnecting V_I at: $T_{ref} = +25^\circ\text{C}$, $V_I = 12\text{ V}$,
 Top trace: output voltage (1 V/div).
 Bottom trace: input voltage (10 V/div).

Output Ripple & Noise

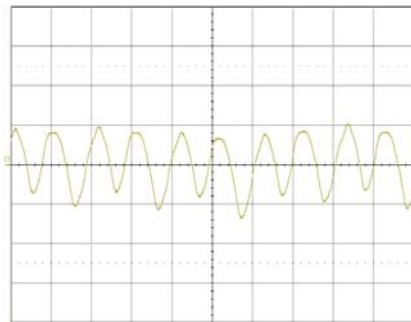

Output voltage ripple at: $T_{ref} = +25^\circ\text{C}$, $V_I = 12\text{ V}$,
 $I_O = 30\text{ A}$ resistive load.
 Trace: output voltage (5 mV/div).
 Time scale: (2 μs /div).

Output Load Transient Response

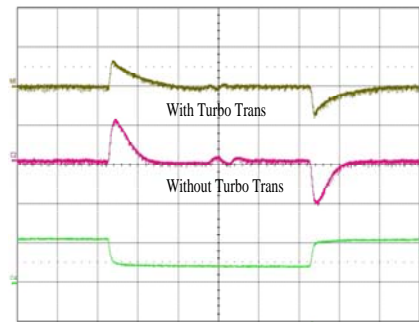

Output voltage response to load current step-change (7.5-22.5-7.5 A) at: $T_{ref} = +25^\circ\text{C}$, $V_I = 12\text{ V}$.
 Top trace: output voltage (100 mV/div).
 Middle trace: output voltage (100 mV/div).
 Bottom trace: load current (20 A/div).

Output Voltage Adjust (see operating information)

Passive adjust

The resistor value for an adjusted output voltage is calculated by using the equations in the operating information.

$$R_{SET} = 30.1\text{ k}\Omega \times \frac{0.7}{V_o - 0.7} - 6.49\text{ k}\Omega$$

PMN 8000 series PoL Regulator
 Input 5.5 - 14 V, Output up to 30 A / 108 W

EN/LZT 146 387 R1B December 2009

© Ericsson AB

2.5V, 30A / 75W Electrical Specification

PMN 8118UW P

$T_{ref} = -40$ to $+85^{\circ}\text{C}$, $V_I = 5.5$ to 14 V, $R_{adj} = 5.23$ k Ω , unless otherwise specified under Conditions.

Typical values given at: $T_{ref} = +25^{\circ}\text{C}$, $V_I = 12$ V, max I_O , unless otherwise specified under Conditions.

Additional $C_{in} = 470$ μF and $C_{out} = 470$ μF . See Operating Information section for selection of capacitor types.

Connect the sense pin, where available, to the output pin.

Characteristics		Conditions	min	typ	max	Unit
V_I	Input voltage range		5.5	12	14	V
V_{loff}	Turn-off input voltage	Decreasing input voltage	3.9	4.2		V
V_{lon}	Turn-on input voltage	Increasing input voltage		5.1	5.3	V
C_I	Internal input capacitance			44		μF
P_O	Output power		0		75	W
η	Efficiency	50 % of max I_O		91.9		%
		max I_O		91.3		
P_d	Power Dissipation	max I_O		7.2	7.7	W
P_{ii}	Input idling power	$I_O = 0$ A, $V_I = 12$ V		1.96		W
P_{RC}	Input standby power	$V_I = 12$ V (turned off with RC)		26.4		mW
I_S	Static Input current	$V_I = 12$ V, max I_O		6.90		A
f_s	Switching frequency	0-100 % of max I_O	430	480	530	kHz

V_{Oi}	Output voltage initial setting and accuracy	$T_{ref} = +25^{\circ}\text{C}$, $V_I = 12$ V, max I_O	2.462	2.500	2.538	V
V_O	Output voltage tolerance band	10-100 % of max I_O	2.425		2.575	V
	Idling voltage	$I_O = 0$ A		2.508		V
	Line regulation	max I_O		± 4		mV
	Load regulation	$V_I = 12$ V, 0-100 % of max I_O		± 7		mV
V_{tr}	Load transient voltage deviation	$V_I = 12$ V, Load step 25-75-25 % of max I_O , $di/dt = 2.5$ A/ μs		± 130		mV
t_{tr}	Load transient recovery time	Without Turbo Trans $C_o = 1000$ μF Type A		60		μs
V_{tr}	Load transient voltage deviation	$V_I = 12$ V, Load step 25-75-25 % of max I_O , $di/dt = 2.5$ A/ μs		± 90		mV
t_{tr}	Load transient recovery time	With Turbo Trans $C_o = 1000$ μF Type A; $R_{TT} = 20$ k Ω		40		μs
t_r	Ramp-up time (from 10–90 % of V_{Oj})	100 % of max I_O		11.0		ms
t_s	Start-up time (from V_I connection to 90 % of V_{Oj})			16.2		ms
t_f	V_I shut-down fall time. (From V_I off to 10 % of V_O)	Max I_O		0.8		ms
		$I_O = 0.1$ A		61.4		ms
$t_{RC} t_{inh}$	RC start-up time	Max I_O		15.4		ms
	RC shut-down fall time	Max I_O		0.3		ms

PMN 8000 series PoL Regulator
Input 5.5 - 14 V, Output up to 30 A / 108 W

EN/LZT 146 387 R1B December 2009

© Ericsson AB

	(From RC off to 10 % of V_o)	$I_o = 0.1 \text{ A}$	0.4	ms
I_o	Output current		0 30	A
I_{lim}	Current limit threshold	$T_{ref} < \max T_{ref}$	56	A
I_{sc}	Short circuit current	$T_{ref} = 25^\circ\text{C}$,	56	A
V_{oac}	Output ripple & noise	See ripple & noise section, max I_o	12.6	mVp-p

PMN 8000 series PoL Regulator
 Input 5.5 - 14 V, Output up to 30 A / 108 W

EN/LZT 146 387 R1B December 2009

© Ericsson AB

2.5V, 30A / 75W Typical Characteristics

PMN 8118UW P

Efficiency

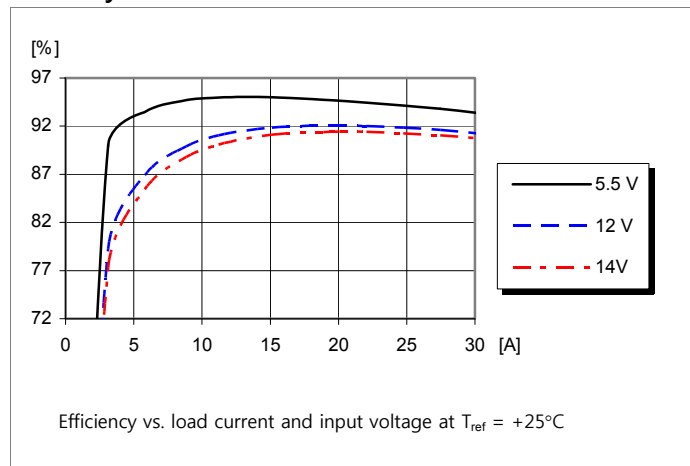

Power Dissipation

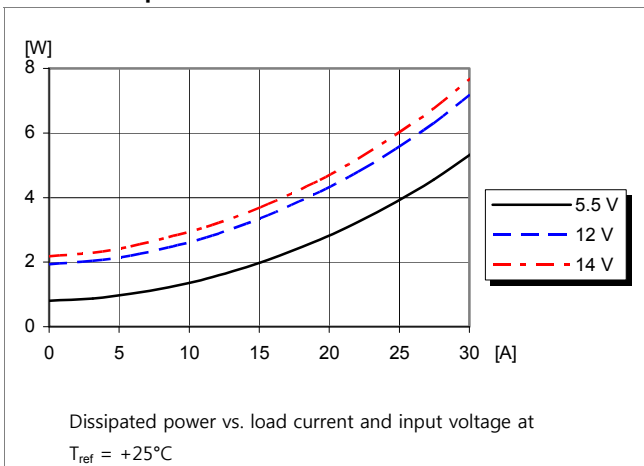

Output Current Derating

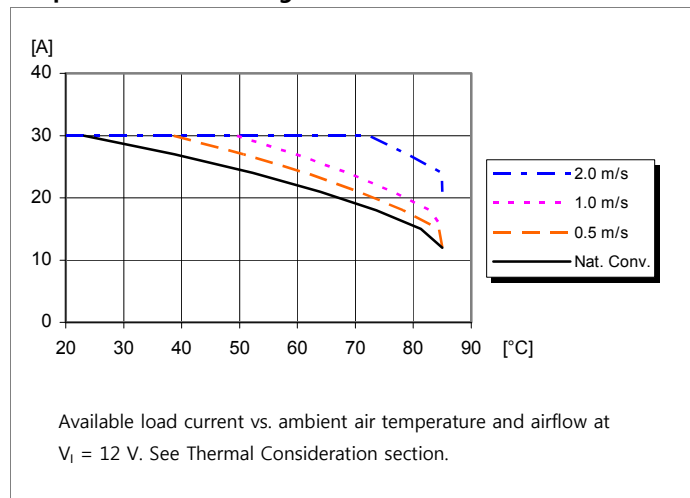

Thermal Resistance

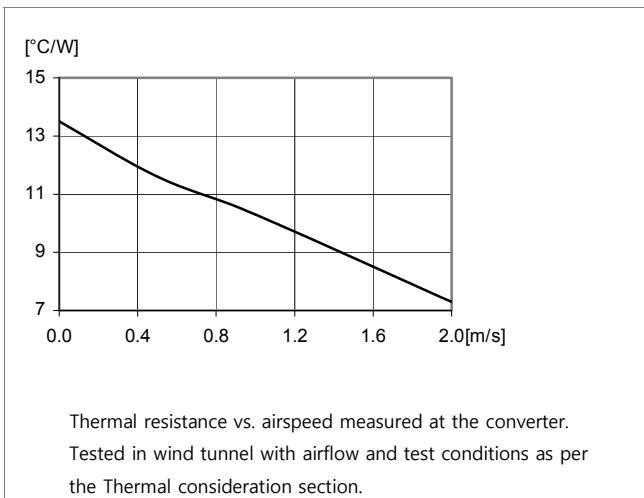

Output Characteristics

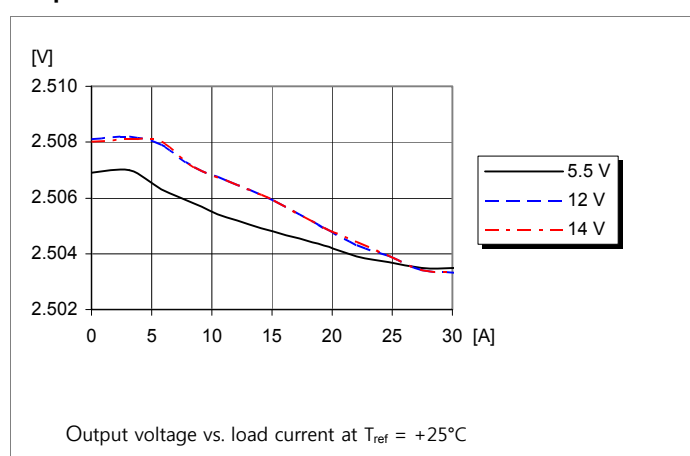

Current Limit Characteristics

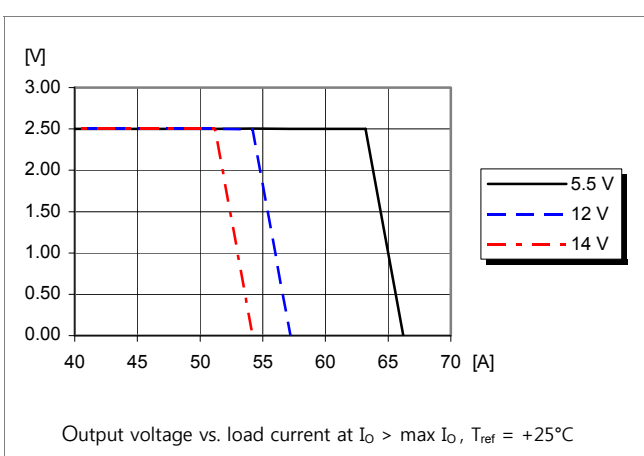

PMN 8000 series PoL Regulator
 Input 5.5 - 14 V, Output up to 30 A / 108 W

EN/LZT 146 387 R1B December 2009

© Ericsson AB

2.5V, 30A / 75W Typical Characteristics

PMN 8118UW P

Start-up

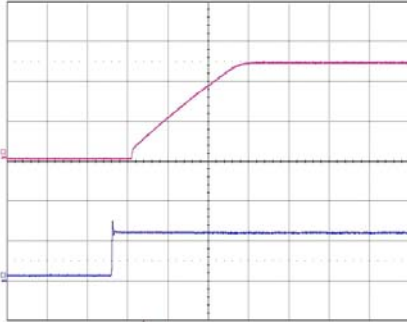

Start-up enabled by connecting V_I at: $T_{ref} = +25^\circ\text{C}$, $V_I = 12\text{ V}$,
 Top trace: output voltage (1 V/div).
 Bottom trace: input voltage (10 V/div).

Shut-down

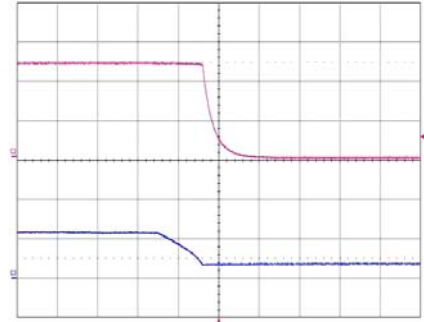

Shut-down enabled by disconnecting V_I at: $T_{ref} = +25^\circ\text{C}$, $V_I = 12\text{ V}$,
 Top trace: output voltage (1 V/div).
 Bottom trace: input voltage (10 V/div).

Output Ripple & Noise

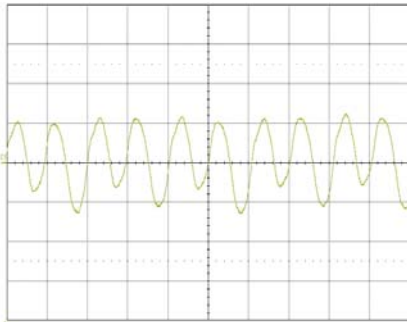

Output voltage ripple at: $T_{ref} = +25^\circ\text{C}$, $V_I = 12\text{ V}$,
 $I_O = 30\text{ A}$ resistive load.
 Trace: output voltage (5 mV/div).
 Time scale: (2 μs /div.).

Output Load Transient Response

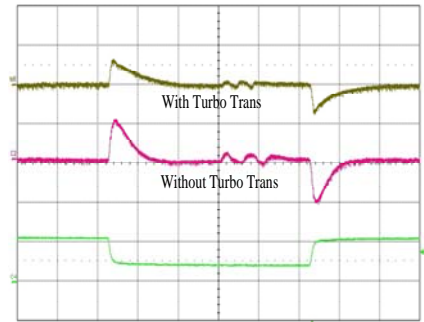

Output voltage response to load current step-change (7.5-22.5-7.5 A) at: $T_{ref} = +25^\circ\text{C}$, $V_I = 12\text{ V}$.
 Top trace: output voltage (100 mV/div).
 Middle trace: output voltage (100 mV/div).
 Bottom trace: load current (20 A/div.).

Output Voltage Adjust (see operating information)

Passive adjust

The resistor value for an adjusted output voltage is calculated by using the equations in the operating information.

$$R_{SET} = 30.1\text{ k}\Omega \times \frac{0.7}{V_o - 0.7} - 6.49\text{ k}\Omega$$

PMN 8000 series PoL Regulator
 Input 5.5 - 14 V, Output up to 30 A / 108 W

EN/LZT 146 387 R1B December 2009

© Ericsson AB

3.3V, 30A / 99W Electrical Specification

PMN 8118UW P

$T_{ref} = -40$ to $+85^{\circ}\text{C}$, $V_I = 5.5$ to 14 V, $R_{adj} = 1.62$ k Ω , unless otherwise specified under Conditions.

Typical values given at: $T_{ref} = +25^{\circ}\text{C}$, $V_I = 12$ V, max I_O , unless otherwise specified under Conditions.

Additional $C_{in} = 470$ μF and $C_{out} = 470$ μF . See Operating Information section for selection of capacitor types.

Connect the sense pin, where available, to the output pin.

Characteristics		Conditions	min	typ	max	Unit
V_I	Input voltage range		5.5	12	14	V
V_{loff}	Turn-off input voltage	Decreasing input voltage	3.9	4.2		V
V_{lon}	Turn-on input voltage	Increasing input voltage		5.1	5.3	V
C_I	Internal input capacitance			44		μF
P_O	Output power		0		99	W
η	Efficiency	50 % of max I_O		92.5		%
		max I_O		92.6		
P_d	Power Dissipation	max I_O		8.0	8.5	W
P_{ii}	Input idling power	$I_O = 0$ A, $V_I = 12$ V		2.64		W
P_{RC}	Input standby power	$V_I = 12$ V (turned off with RC)		18.8		mW
I_S	Static Input current	$V_I = 12$ V, max I_O		9.00		A
f_s	Switching frequency	0-100 % of max I_O	430	480	530	kHz

V_{Oi}	Output voltage initial setting and accuracy	$T_{ref} = +25^{\circ}\text{C}$, $V_I = 12$ V, max I_O	3.250	3.300	3.350	V
V_O	Output voltage tolerance band	10-100 % of max I_O	3.201		3.399	V
	Idling voltage	$I_O = 0$ A		3.312		V
	Line regulation	max I_O		± 4		mV
	Load regulation	$V_I = 12$ V, 0-100 % of max I_O		± 7		mV
V_{tr}	Load transient voltage deviation	$V_I = 12$ V, Load step 25-75-25 % of max I_O , $di/dt = 2.5$ A/ μs		± 130		mV
t_{tr}	Load transient recovery time	Without Turbo Trans $C_o = 1000$ μF Type A		60		μs
V_{tr}	Load transient voltage deviation	$V_I = 12$ V, Load step 25-75-25 % of max I_O , $di/dt = 2.5$ A/ μs		± 90		mV
t_{tr}	Load transient recovery time	With Turbo Trans $C_o = 1000$ μF Type A; $R_{TT} = 20$ k Ω		40		μs
t_r	Ramp-up time (from 10–90 % of V_{Oj})	100 % of max I_O		11.1		ms
t_s	Start-up time (from V_I connection to 90 % of V_{Oj})			16.4		ms
t_f	V_I shut-down fall time. (From V_I off to 10 % of V_{Oj})	Max I_O		0.8		ms
		$I_O = 0.1$ A		67.7		ms
$t_{RC} t_{inh}$	RC start-up time	Max I_O		16.1		ms
	RC shut-down fall time	Max I_O		0.3		ms

PMN 8000 series PoL Regulator
 Input 5.5 - 14 V, Output up to 30 A / 108 W

EN/LZT 146 387 R1B December 2009

© Ericsson AB

PMN 8118UW P

3.3V, 30A / 99W Typical Characteristics

Efficiency

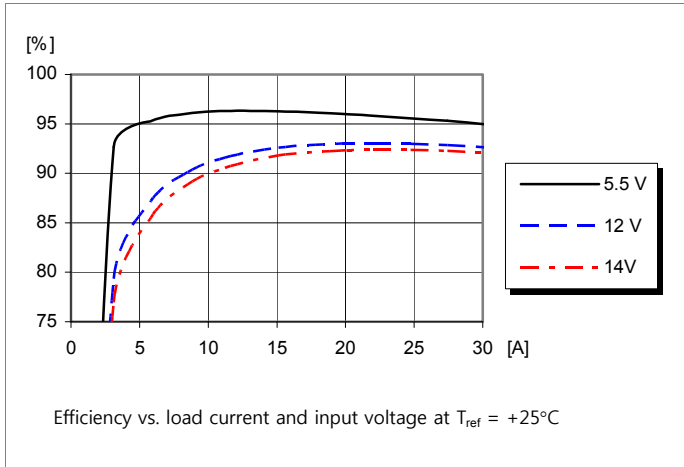

Power Dissipation

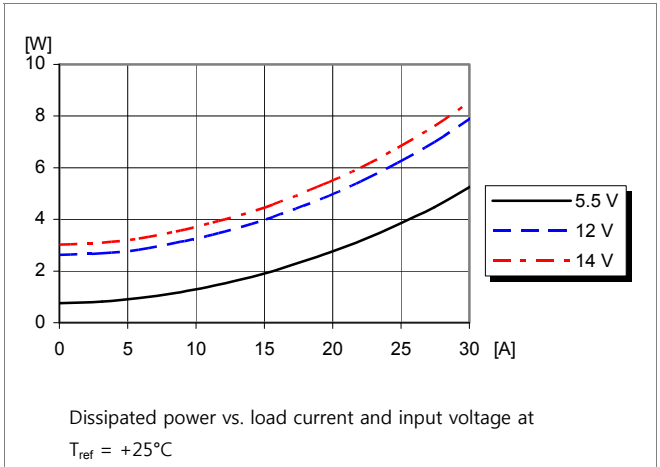

Output Current Derating

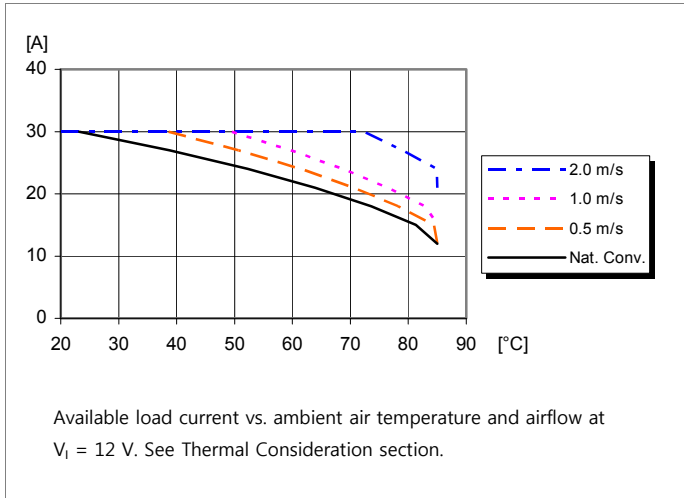

Thermal Resistance

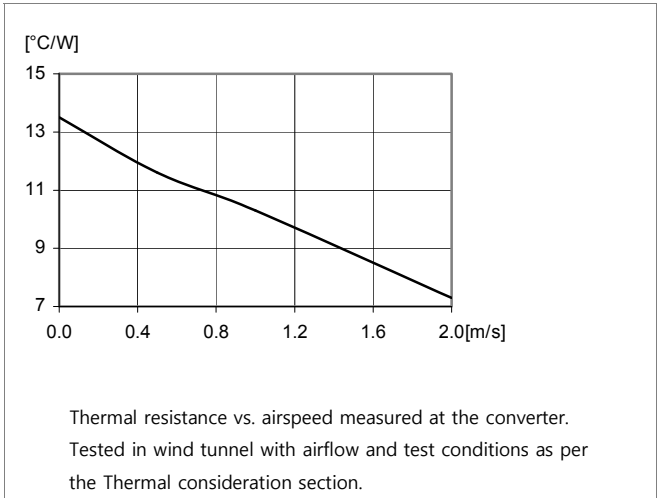

Output Characteristics

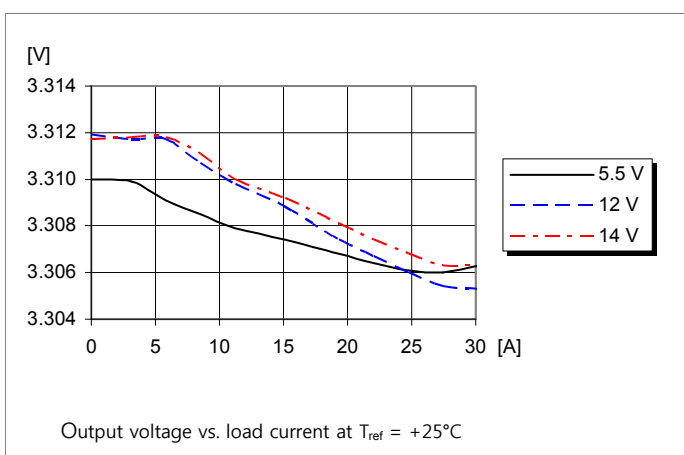

Current Limit Characteristics

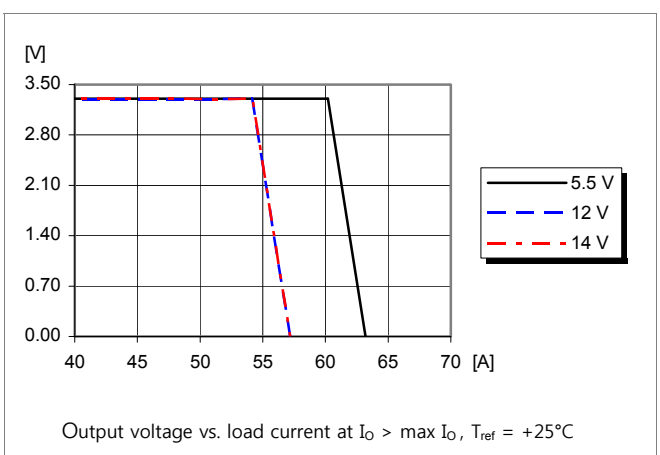

PMN 8000 series PoL Regulator
 Input 5.5 - 14 V, Output up to 30 A / 108 W

EN/LZT 146 387 R1B December 2009

© Ericsson AB

3.3V, 30A / 99W Typical Characteristics

PMN 8118UW P

Start-up

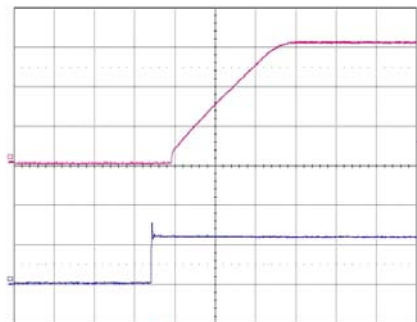

Start-up enabled by connecting V_I at: $T_{ref} = +25^\circ\text{C}$, $V_I = 12\text{ V}$,
 Top trace: output voltage (1 V/div).
 Bottom trace: input voltage (10 V/div).

Shut-down

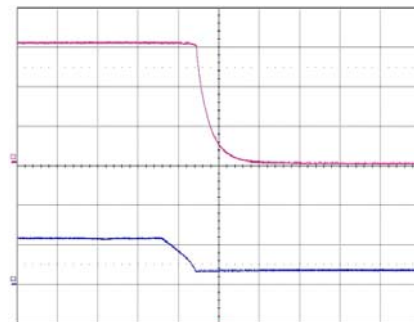

Shut-down enabled by disconnecting V_I at: $T_{ref} = +25^\circ\text{C}$, $V_I = 12\text{ V}$,
 Top trace: output voltage (1 V/div).
 Bottom trace: input voltage (10 V/div).

Output Ripple & Noise

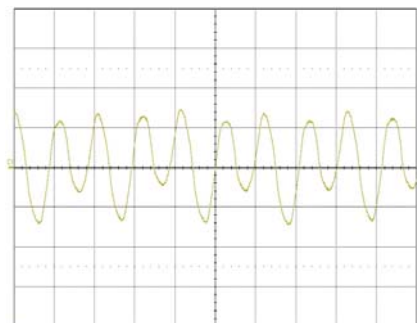

Output voltage ripple at: $T_{ref} = +25^\circ\text{C}$, $V_I = 12\text{ V}$,
 $I_O = 30\text{ A}$ resistive load.
 Trace: output voltage (5 mV/div).
 Time scale: (2 μs /div.).

Output Load Transient Response

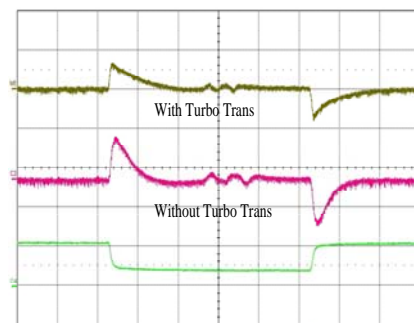

Output voltage response to load current step-change (7.5-22.5-7.5 A) at: $T_{ref} = +25^\circ\text{C}$, $V_I = 12\text{ V}$.
 Top trace: output voltage (100 mV/div).
 Middle trace: output voltage (100 mV/div).
 Bottom trace: load current (20 A/div.).

Output Voltage Adjust (see operating information)

Passive adjust

The resistor value for an adjusted output voltage is calculated by using the equations in the operating information.

$$R_{SET} = 30.1\text{ k}\Omega \times \frac{0.7}{V_o - 0.7} - 6.49\text{ k}\Omega$$

PMN 8000 series PoL Regulator
 Input 5.5 - 14 V, Output up to 30 A / 108 W

EN/LZT 146 387 R1B December 2009

© Ericsson AB

EMC Specification

Conducted EMI measured according to test set-up.
 The fundamental switching frequency is 480 kHz for
 PMN 8118UW P @ $V_i = 12\text{ V}$, max I_o .

Conducted EMI Input terminal value (typ)

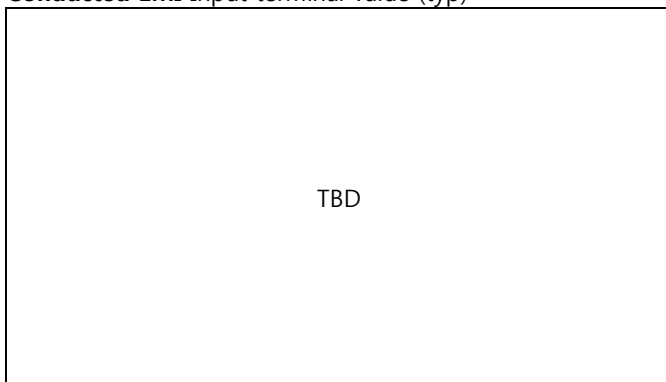

EMI without filter

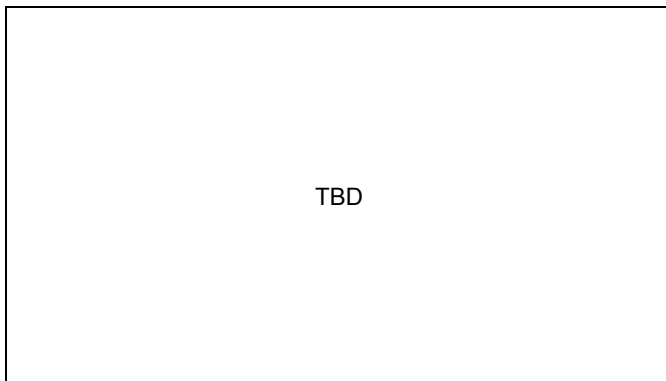

Test set-up

Layout recommendation

The radiated EMI performance of the DC/DC regulator will depend on the PCB layout and ground layer design.

It is also important to consider the stand-off of the DC/DC regulator.

If a ground layer is used, it should be connected to the output of the DC/DC regulator and the equipment ground or chassis.

A ground layer will increase the stray capacitance in the PCB and improve the high frequency EMC performance.

PMN 8000 series PoL Regulator
 Input 5.5 - 14 V, Output up to 30 A / 108 W

EN/LZT 146 387 R1B December 2009

© Ericsson AB

Output ripple and noise

Output ripple and noise measured according to figure below.

See Design Note 022 for detailed information.

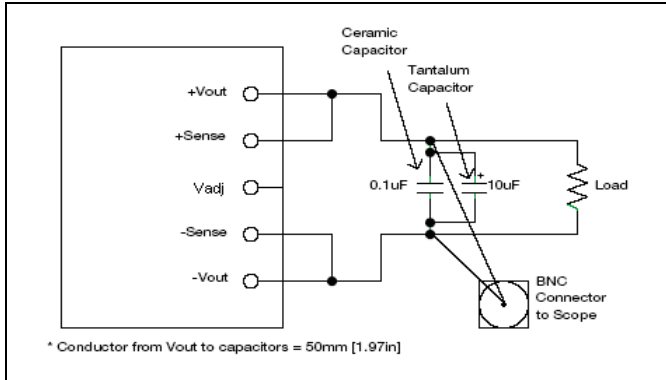

Output ripple and noise test setup

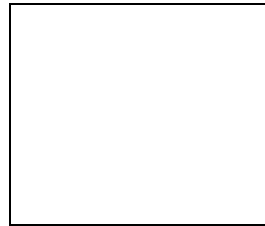

pull up resistor to + In.

The maximum required sink current is 1 mA. When the RC pin is left open, the voltage generated on the RC pin is 5.5 – 14 V. The regulator will turn on when the input voltage is applied with the RC pin open. Turn off is achieved by connecting the RC pin to the - In. To ensure safe turn off the voltage difference between RC pin and the - In pin shall be less than 1V. The regulator will restart automatically when this connection is opened.

Operating information

Extended information for POLA products is found in Application Note 205.

Input Voltage

The input voltage range 5.5 to 14 Vdc makes the product easy to use in intermediate bus applications when powered by a regulated bus converter.

Turn-off Input Voltage

The DC/DC regulators monitor the input voltage and will turn on and turn off at predetermined levels.

The minimum hysteresis between turn on and turn off input voltage is 0.1V.

Remote Control (RC) Inhibit

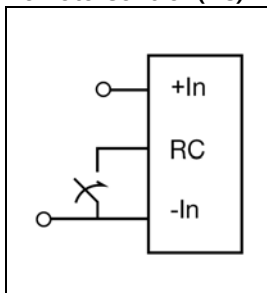

The products are fitted with a remote control function referenced to positive logic. The RC function allows the regulator to be turned on/off by an external device like a semiconductor or mechanical switch. The RC pin has an internal

External Capacitors

Input capacitors:

The recommended input capacitors are determined by the 470 μ F minimum capacitance and 500 mArms minimum ripple current rating.

For high-performance/transient application, or wherever the input source performance is degraded, 1000 μ F of input capacitance is recommended. The additional input capacitance above the minimum level insures an optimized performance.

Output capacitors:

The recommended output capacitance of 470 μ F will allow the module to meet its transient response specification as defined in the electrical specification.

When using one or more non-ceramic capacitors, the calculated equivalent ESR should be no lower than 4 m Ω (7m Ω using the manufacturer's maximum ESR for a single capacitor).

Turbo Trans™ allows the designer to optimize the capacitance load according to the system transient design

PMN 8000 series PoL Regulator
 Input 5.5 - 14 V, Output up to 30 A / 108 W

EN/LZT 146 387 R1B December 2009
 © Ericsson AB

requirement. High quality, ultra-low ESR capacitors are required to maximize Turbo Trans™ effectiveness. Capacitors with a capacitance (μF)×ESR (mΩ) ≤ 10,000 mΩ × μF are required.

Required Capacitor with Turbo Trans. See the Turbo Trans™ Application information for Capacitor Selection. Capacitor Type Group by ESR (Equivalent Series Resistance)

Type A = (100 < capacitance × ESR ≤ 1,000)

Type B = (1,000 < capacitance × ESR ≤ 5,000)

Type C = (5,000 < capacitance × ESR ≤ 10,000)

Input And Output Impedance

The impedance of both the input source and the load will interact with the impedance of the DC/DC regulator. It is important that the input source has low characteristic impedance. The regulators are designed for stable operation without external capacitors connected to the input or output. The performance in some applications can be enhanced by addition of external capacitance as described under External Decoupling Capacitors. If the input voltage source contains significant inductance, the addition of a 100 μF capacitor across the input of the regulator will ensure stable operation. The capacitor is not required when powering the DC/DC regulator from an input source with an inductance below 10 μH.

External Decoupling Capacitors

When powering loads with significant dynamic current requirements, the voltage regulation at the point of load can be improved by addition of decoupling capacitors at the load.

The most effective technique is to locate low ESR ceramic and electrolytic capacitors as close to the load as possible, using several parallel capacitors to lower the effective ESR.

The ceramic capacitors will handle high-frequency dynamic load changes while the electrolytic capacitors are used to handle low frequency dynamic load changes. Ceramic capacitors will also reduce any high frequency noise at the load.

It is equally important to use low resistance and low inductance PCB layouts and cabling.

External decoupling capacitors will become part of the control loop of the DC/DC regulator and may affect the stability margins. As a “rule of thumb”, 100 μF/A of output current can be added without any additional analysis. The ESR of the capacitors is a very important parameter. Power Modules guarantee stable operation with a verified ESR value of >10 mΩ across the output connections. For further information please contact your local Ericsson Power Modules representative.

Output Voltage Adjust (V_{adj})

The DC/DC regulators have an Output Voltage Adjust pin (V_{adj}). This pin can be used to adjust the output voltage above or below Output voltage initial setting.

To increase or decrease the voltage, the resistor should be connected between the V_{adj} pin and GND pin. The resistor value of the output voltage adjust function is according to information given under the output section for the respective product.

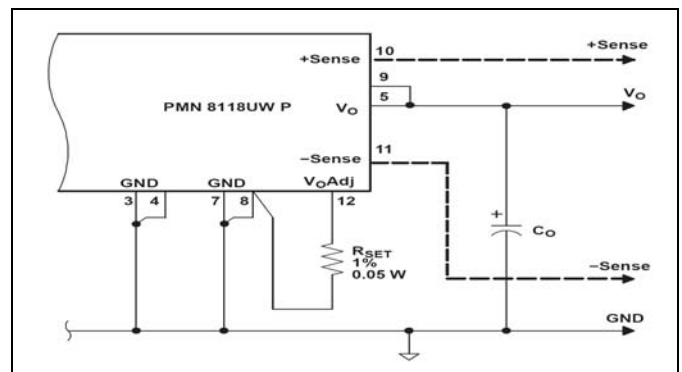

Parallel Operation

Two regulators may be paralleled for redundancy if the total power is equal or less than P_O max. It is not recommended

PMN 8000 series PoL Regulator
Input 5.5 - 14 V, Output up to 30 A / 108 W

EN/LZT 146 387 R1B December 2009

© Ericsson AB

to parallel the regulators without using external current sharing circuits.

Remote Sense

The DC/DC regulators have remote sense that can be used to compensate for voltage drops between the output and the point of load. The sense traces should be located close to the PCB ground layer to reduce noise susceptibility. The remote sense circuitry will compensate for up to 10% voltage drop between output pins and the point of load.

If the remote sense is not needed +Sense should be connected to +Out and -Sense should be connected to -Out.

Over Temperature Protection (OTP)

The regulators are protected from thermal overload by an internal over temperature shutdown circuit.

When T_{ref} as defined in thermal consideration section exceeds the OTP threshold, the regulator will shut down.

The DC/DC regulator will make continuous attempts to start up (non-latching mode) and resume normal operation automatically when the temperature has dropped $>10^{\circ}\text{C}$ below the temperature threshold.

Over Current Protection (OCP)

The regulators include current limiting circuitry for protection at continuous overload.

The output voltage will decrease towards zero for output currents in excess of max output current ($\text{max } I_O$). The regulator will resume normal operation after removal of the overload. The load distribution should be designed for the maximum output short circuit current specified.

Soft-start Power Up

From the moment a valid input voltage is applied, the soft-start control introduces a short time-delay (typically 5-10 ms) before allowing the output voltage to rise.

The initial rise in input current when the input voltage first starts to rise is the charge current drawn by the input

capacitors. Power-up is complete within 15 ms.

Auto Track™ Function

Auto Track™ was designed to simplify the amount of circuitry required to make the output voltage from each module power up and power down in sequence. The sequencing of two or more supply voltages during power up is a common requirement for complex mixed-signal applications, that use dual-voltage VLSI ICs such as DSPs, micro-processors and ASICs.

Adjustable Undervoltage Lockout

The regulators incorporate an input undervoltage lockout (UVLO). The UVLO feature prevents the operation of the module until there is a sufficient input voltage to produce a valid output voltage. This enables the module to provide a clean, monotonic powerup for the load circuit and also limit the magnitude of current drawn from regulator's input source during the power-up sequence.

The UVLO characteristic is defined by the ON threshold (V_{THD}) voltage. Below the ON threshold, the Inhibit control is overridden, and the module does not produce an output. The hysteresis voltage, which is the difference oscillations, which can occur if the input voltage drops slightly when the modules begins to draw current from the input source.

The UVLO feature of the PMN 8118UW P module allows for limited adjustment of the ON threshold voltage. The adjustment is made via the Inhibit/UVLO Prog control pin (Pin 1) using a single resistor (see figure below). When pin 1 is left open, the ON threshold voltage is internally set to its default value. The ON threshold has a nominal voltage of 5.0 V and a hysteresis of 900 mV. This ensures that the module produces a regulated output when the minimum input voltage is applied. The ON threshold might need to be increased if the module is powered from a tightly regulated 12 V bus. This allows the ON threshold voltage to be set for a specified input voltage. Adjusting the threshold voltage prevents the module from operating if the input

PMN 8000 series PoL Regulator
 Input 5.5 - 14 V, Output up to 30 A / 108 W

EN/LZT 146 387 R1B December 2009
 © Ericsson AB

bus fails to completely rise to its specified regulation voltage.

The below equation determines the value of R_{UVLO} required to adjust V_{THD} to a new value. The default value is 5 V and it may only be adjusted to a higher value.

$$R_{UVLO} = \frac{2590 - (24.9 \times (V_{THD} - 1))}{24.9 \times (V_{THD} - 1) - 100} (k\Omega)$$

Calculated Values of R_{UVLO} for Various Values of V_{THD}

V_{THD}	6.5 V	7.0 V	7.5 V	8.0 V	8.5 V	9.0 V	9.5 V	10.0 V	10.5 V
R_{UVLO}	66.5 k Ω	49.9 k Ω	39.2 k Ω	32.4 k Ω	27.4 k Ω	24.3 k Ω	21.5 k Ω	19.1 k Ω	17.4 k Ω

The above table lists the standard resistor values for R_{UVLO} for different values of the ON threshold (V_{THD}) voltage. The figure of UVLO Program Resistor Placement is as follow.

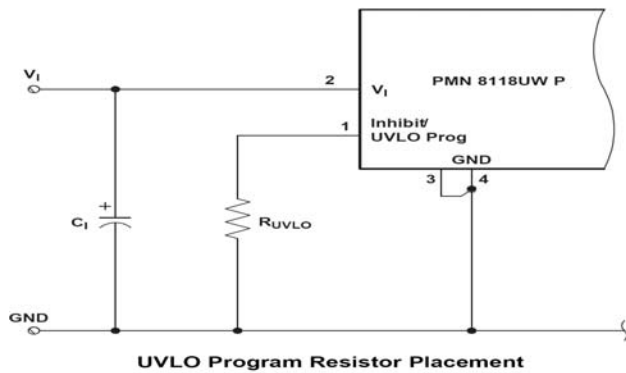

Turbo Trans™ Technology

Turbo Trans™ optimizes the transient response of the regulator with added external capacitance using a single external resistor. The benefits of this technology include: reduced output capacitance, minimized output voltage deviation following a load transient, and enhanced stability when using ultra-low ESR output capacitors. The amount of output capacitance required to meet a target output voltage deviation, is reduced with Turbo Trans™ activated. Likewise, for a given amount of output capacitance, with Turbo Trans™ engaged, the amplitude of the voltage deviation following a load transient is reduced. Applications

requiring tight transient voltage tolerances and minimized capacitor footprint area benefit from this technology.

Utilizing Turbo Trans™ requires connecting a resistor, R_{TT} , between the +Sense pin (pin 10) and the Turbo Trans™ pin (pin 13). The value of the resistor directly corresponds to the amount of output capacitance required. For the PMN 8118UW P, the minimum required capacitance is 470 μ F. When using Turbo Trans™, capacitors with a capacitance \times ESR product below 10,000 μ F \times m Ω are required.

To see the benefit of Turbo Trans™, follow the 5mV/A marking across to the "Without Turbo Trans™" plot. Following that point down shows that more than 8,200 μ F of output capacitance is required to meet the same transient deviation limit. This is the benefit of Turbo Trans™. A typical Turbo Trans™ application schematic is also shown.

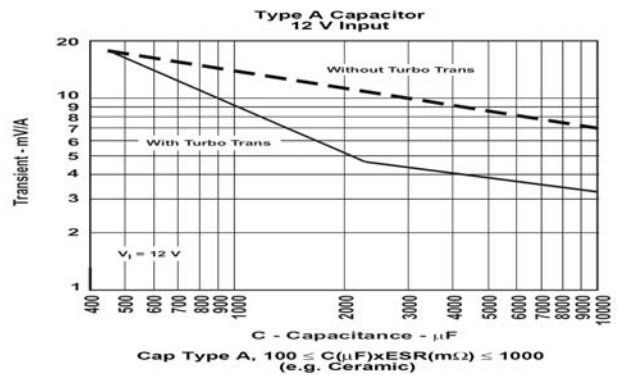

TurboTrans C_O Values & Required R_{TT} Selection Table

Transient Voltage Deviation (mV)			12 V Input		8 V Input	
25% Load Step (7.5 A)	50% Load Step (15 A)	75% Load Step (22.5 A)	C_O Minimum Required Output Capacitance (μ F)	R_{TT} Required TurboTrans Resistor (Ω)	C_O Minimum Required Output Capacitance (μ F)	R_{TT} Required TurboTrans Resistor (Ω)
130	260	390	470	open	580	127 k
120	240	360	520	294 k	640	80.6 k
110	220	330	580	127 k	710	54.9 k
100	200	300	650	76.8 k	800	37.4 k
90	180	270	740	47.5 k	900	26.7 k
80	160	240	850	31.6 k	1050	17.8 k
70	140	210	1000	20.5 k	1250	11.3 k
60	120	180	1200	12.7 k	1500	6.65 k
50	100	150	1500	6.65 k	1900	2.55 k
40	80	120	2000	1.82 k	2600	0
30	60	90	4000	0	7800	0

PMN 8000 series PoL Regulator
Input 5.5 - 14 V, Output up to 30 A / 108 W

EN/LZT 146 387 R1B December 2009

© Ericsson AB

R_{TT} Resistor Selection

The Turbo Trans™ resistor value, R_{TT} can be determined from the Turbo Trans™ programming equation, see the equation below.

$$R_{TT} = 40 \times \frac{1 - \left(\frac{C_o}{2350}\right)}{5 \times \left(\frac{C_o}{2350}\right) - 1} (k\Omega)$$

Where C_o is the total output capacitance in μF. C_o values greater than or equal to 2350 μF require R_{TT} to be a short, 0Ω. (The above equation results in a negative value for R_{TT} when C_o ≥ 2350 μF)

$$R_{TT} = 40 \times \frac{1 - \left(\frac{C_o}{2350}\right)}{5 \times \left(\frac{C_o}{2350}\right) - 1} (k\Omega)$$

Where C_o is the total output capacitance in μF. C_o values greater than or equal to 2350 μF require R_{TT} to be a short, 0Ω. (The above equation results in a negative value for R_{TT} when C_o ≥ 2350 μF)

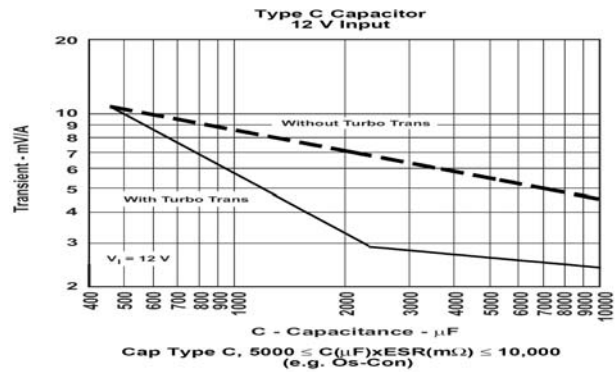
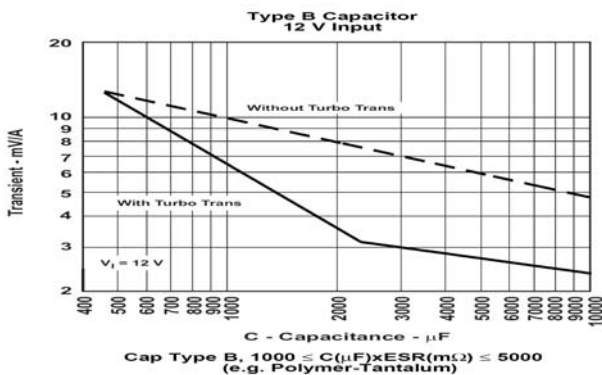

Type B TurboTrans C_o Values & Required R_{TT} Selection Table

Type C TurboTrans C_o Values & Required R_{TT} Selection Table

Transient Voltage Deviation (mV)			12 V Input		8 V Input	
25% Load Step (7.5 A)	50% Load Step (15 A)	75% Load Step (22.5 A)	C _o Minimum Required Output Capacitance (μF)	R _{TT} Required TurboTrans Resistor (Ω)	C _o Minimum Required Output Capacitance (μF)	R _{TT} Required TurboTrans Resistor (Ω)
100	200	300	470	open	540	205 k
90	180	270	500	499 k	620	93.1 k
80	160	240	580	127 k	720	52.3 k
70	140	210	680	63.4 k	840	32.4 k
60	120	180	800	37.4 k	1000	20.5 k
50	100	150	1000	20.5 k	1300	10.2 k
40	80	120	1300	10.2 k	1700	4.22 k
30	60	90	1800	3.32 k	2300	221
25	50	75	2200	698	4900	0
20	40	60	5400	0	14000	0

Transient Voltage Deviation (mV)			12 V Input		8 V Input	
25% Load Step (7.5 A)	50% Load Step (15 A)	75% Load Step (22.5 A)	C _o Minimum Required Output Capacitance (μF)	R _{TT} Required TurboTrans Resistor (Ω)	C _o Minimum Required Output Capacitance (μF)	R _{TT} Required TurboTrans Resistor (Ω)
80	160	240	470	open	520	294 k
70	140	210	560	158 k	620	93.1 k
60	120	180	680	63.4 k	750	45.3 k
50	100	150	850	31.6 k	940	24.3 k
40	80	120	1100	15.8 k	1300	10.2 k
35	70	105	1300	10.2 k	1500	6.65 k
30	60	90	1600	5.36 k	1800	3.32 k
25	50	75	2000	1.82 k	2200	698
20	40	60	4000	0	5400	0

R_{TT} Resistor Selection

The Turbo Trans™ resistor value, R_{TT} can be determined from the Turbo Trans™ programming equation, see the equation below.

$$R_{TT} = 40 \times \frac{1 - \left(\frac{C_o}{2350}\right)}{5 \times \left(\frac{C_o}{2350}\right) - 1} (k\Omega)$$

Where C_o is the total output capacitance in μF. C_o values

PMN 8000 series PoL Regulator
 Input 5.5 - 14 V, Output up to 30 A / 108 W

EN/LZT 146 387 R1B December 2009

© Ericsson AB

greater than or equal to 2350 μF require R_{TT} to be a short, 0Ω . (The above equation results in a negative value for R_{TT} when $C_o \geq 2350 \mu\text{F}$)

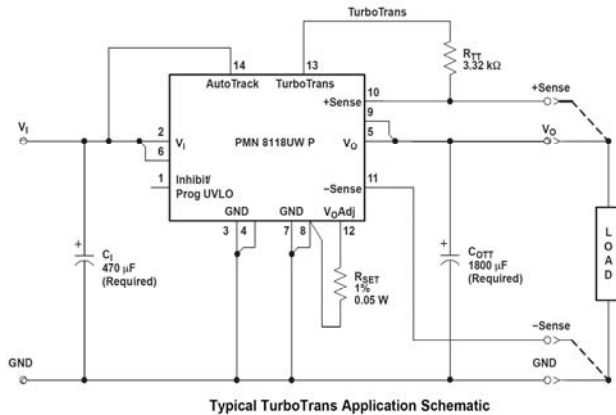

Thermal Consideration

General

The regulators are designed to operate in different thermal environments and sufficient cooling must be provided to ensure reliable operation.

Cooling is achieved mainly by conduction, from the pins to the host board, and convection, which is dependant on the airflow across the regulator. Increased airflow enhances the cooling of the regulator.

The Output Current Derating graph found in the Output section for each model provides the available output current vs. ambient air temperature and air velocity at $V_{\text{in}} = 5 \text{ V}$.

The DC/DC regulator is tested on a 254 x 254 mm, 35 μm (1 oz), 8-layer test board mounted vertically in a wind tunnel with a cross-section of 305 x 305 mm.

Proper cooling of the DC/DC regulator can be verified by measuring the temperature at positions P1, P2 and P3. The temperature at these positions should not exceed the max values provided in the table below.

Note that the max value is the absolute maximum rating (non destruction) and that the electrical Output data is guaranteed up to ambient temperature +85°C.

See Design Note 019 for further information.

Position	Device	Designation	max value
P ₁	Pcb		130° C
P ₂	Mosfet		130° C
P ₃	Inductor	T _{ref}	130° C

PMN 8000 series PoL Regulator
Input 5.5 - 14 V, Output up to 30 A / 108 W

EN/LZT 146 387 R1B December 2009

© Ericsson AB

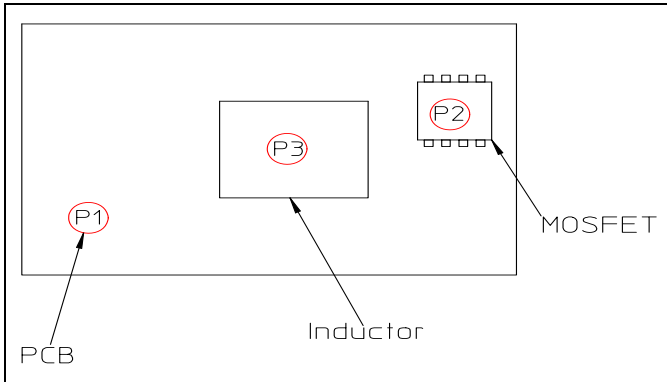

PMN 8000 series PoL Regulator Input 5.5 - 14 V, Output up to 30 A / 108 W	EN/LZT 146 387 R1B December 2009
	© Ericsson AB

Thermal Consideration continued

such as the PCB size, number of layers and direction of airflow.

Definition of reference temperature (T_{ref})

The reference temperature is used to monitor the temperature limits of the product. Temperatures above maximum T_{ref} are not allowed and may cause degradation or permanent damage to the product. T_{ref} is also used to define the temperature range for normal operating conditions.

T_{ref} is defined by the design and used to guarantee safety margins, proper operation and high reliability of the module.

Ambient Temperature Calculation

By using the thermal resistance the maximum allowed ambient temperature can be calculated.

1. The power loss is calculated by using the formula

$((1/\eta) - 1) \times \text{output power} = \text{power losses (Pd)}$.

η = efficiency of regulator. E.g 89.5 % = 0.895

2. Find the thermal resistance (R_{th}) in the Thermal Resistance graph found in the Output section for each model.

Calculate the temperature increase (ΔT).

$$\Delta T = R_{th} \times P_d$$

3. Max allowed ambient temperature is:

Max $T_{ref} - \Delta T$.

E.g PMN 8118UW P at 0m/s:

$$1. ((\frac{1}{0.926}) - 1) \times 99 \text{ W} = 7.91 \text{ W}$$

$$2. 7.91 \text{ W} \times 13.5^\circ\text{C/W} = 106.8^\circ\text{C}$$

$$3. 130^\circ\text{C} - 106.8^\circ\text{C} = \text{max ambient temperature is } 23.2^\circ\text{C}$$

The actual temperature will be dependent on several factors

PMN 8000 series PoL Regulator
 Input 5.5 - 14 V, Output up to 30 A / 108 W

EN/LZT 146 387 R1B December 2009

© Ericsson AB

Connections

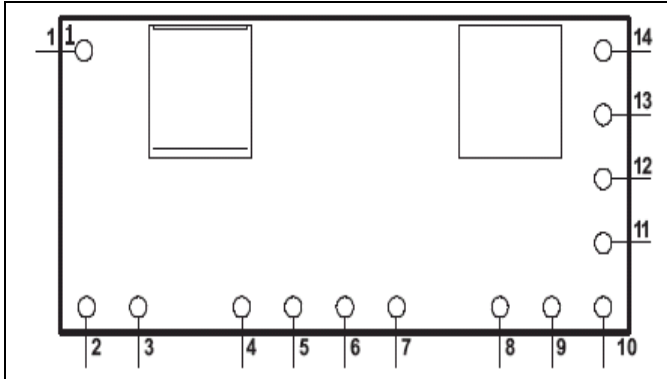

Pin	Designation	Function
1	Inhibit/ UVLO Adjust	The Inhibit pin is an open-collector/drain, negative logic input that is referenced to GND. Applying a low level ground signal to this input disables the module's output voltage. If the Inhibit pin is left open-circuit, the module produces an output whenever a valid input source is applied. This input is not compatible with TTL logic devices and should not be tied V_i or other voltage. This pin is also used for input
2	V_i	The positive input voltage power node to the module, which is referenced to common GND.
3	GND	This is the common ground connection for the V_i and V_o power connections. It is also the 0 V_{dc} reference for the control inputs.
4	GND	This is the common ground connection for the V_i and V_o power connections. It is also the 0 V_{dc} reference for the control inputs.
5	V_o	The regulated positive power output with respect to the GND.
6	V_i	The positive input voltage power node to the module, which is referenced to common GND.

7	GND	This is the common ground connection for the V_i and V_o power connections. It is also the 0 V_{dc} reference for the control inputs.
8	GND	This is the common ground connection for the V_i and V_o power connections. It is also the 0 V_{dc} reference for the control inputs.
9	V_o	The regulated positive power output with respect to the GND.
10	+Sense	The sense input allows the regulation circuit to compensate for voltage drop between the module and the load. For optimal voltage accuracy, +Sense must
11	-Sense	The sense input allows the regulation circuit to compensate for voltage drop between the module and the load. For optimal voltage accuracy, -Sense must be connected GND (pin 3) very close to
12	V_o Adjust	A 0.1 W 1% resistor must be directly connected between this pin and pin 8 (GND) to set the output voltage to a value higher than 0.7 V. The temperature stability of the resistor should be 100 ppm/°C (or better). The setpoint range for the output voltage is from 0.7V to 3.6V. If left open circuit, the output voltage defaults to its lowest value. For further
13	Turbo Trans	This input pin adjusts the transient response of the regulator. To activate the Turbo Trans™ feature, a 1%, 50mW resistor must be connected between this pin and pin 10 (+Sense) very close to the module. For a given value of output capacitance, a reduction in peak output voltage deviation is achieved by using this feature. If unused, this pin must be left open-circuit. External capacitance must

PMN 8000 series PoL Regulator
 Input 5.5 - 14 V, Output up to 30 A / 108 W

EN/LZT 146 387 R1B December 2009

© Ericsson AB

14	Track	<p>This is an analog control input that enables the output voltage to follow an external voltage. This pin becomes active typically 20 ms after the input voltage has been applied, and allows direct control of the output voltage from 0 V up to the nominal set-point voltage. Within the control voltage is raised above this range, the module regulates at its set-point voltage. The features allows the output voltage to rise simultaneously with other modules powered from the same input bus. If unused, this input should be connected to V_{SS}.</p>
----	-------	--

PMN 8000 series PoL Regulator
 Input 5.5 - 14 V, Output up to 30 A / 108 W

EN/LZT 146 387 R1B December 2009
 © Ericsson AB

Mechanical Information (surface mount versions)

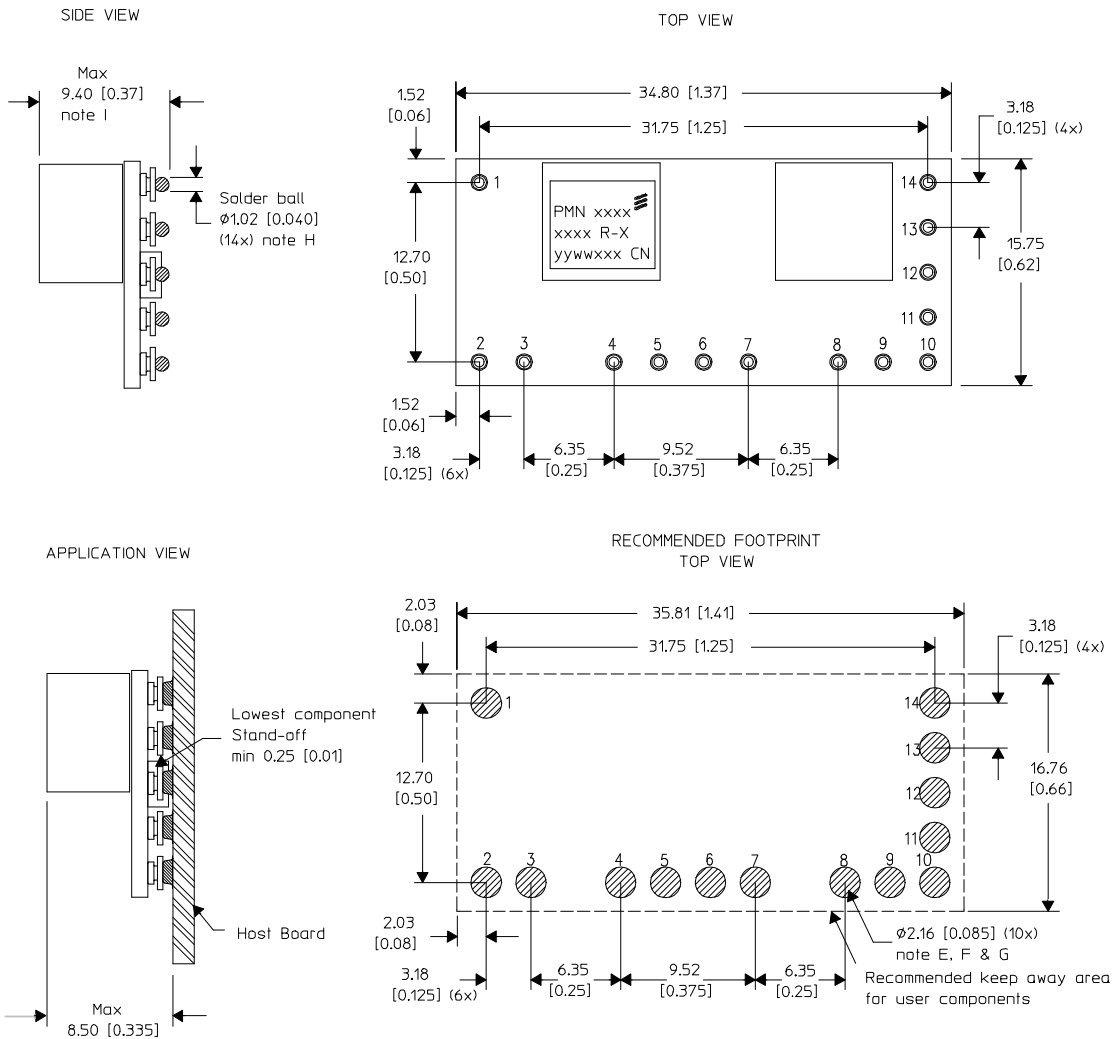

Notes:

- A. All linear dimensions are mm [inch].
- B. This drawing is subject to change without notice.
- C. 1 place decimals are ± 0.75 [± 0.030]
- D. 2 place decimals are ± 0.25 [± 0.010]
- E. Power pin connection should utilize two or more vias to the interior power plane of $\phi 0.63$ [0.025] per input, ground and output pin (or the electrical equivalent).

- F. Paste screen opening: $\phi 2.03$ [0.080] to $\phi 2.16$ [0.085]
 Paste screen thickness: 0.15 [0.006]
- G. Pad type: solder mask defined
- H. All pins: Material - Copper Alloy
 Plating - 10 μ m Tin over 4 μ m Nickel
 Solder Ball - Black collar 63 Sn / 37 Pb
 Blue collar 96.5 Sn / 3.0 Ag / 0.5 Cu
- I. Dimension prior to reflow solder.

MECHANICAL DATA FOR THE PMN DC/DC REGULATOR

Weight: typical 8 g
 Use recommended footprint and solder recommendations together with solder reflow recommendations to ensure a reliable interconnection.

PMN 8000 series PoL Regulator
 Input 5.5 - 14 V, Output up to 30 A / 108 W

EN/LZT 146 387 R1B December 2009
 © Ericsson AB

Mechanical Information (Through hole mount version)

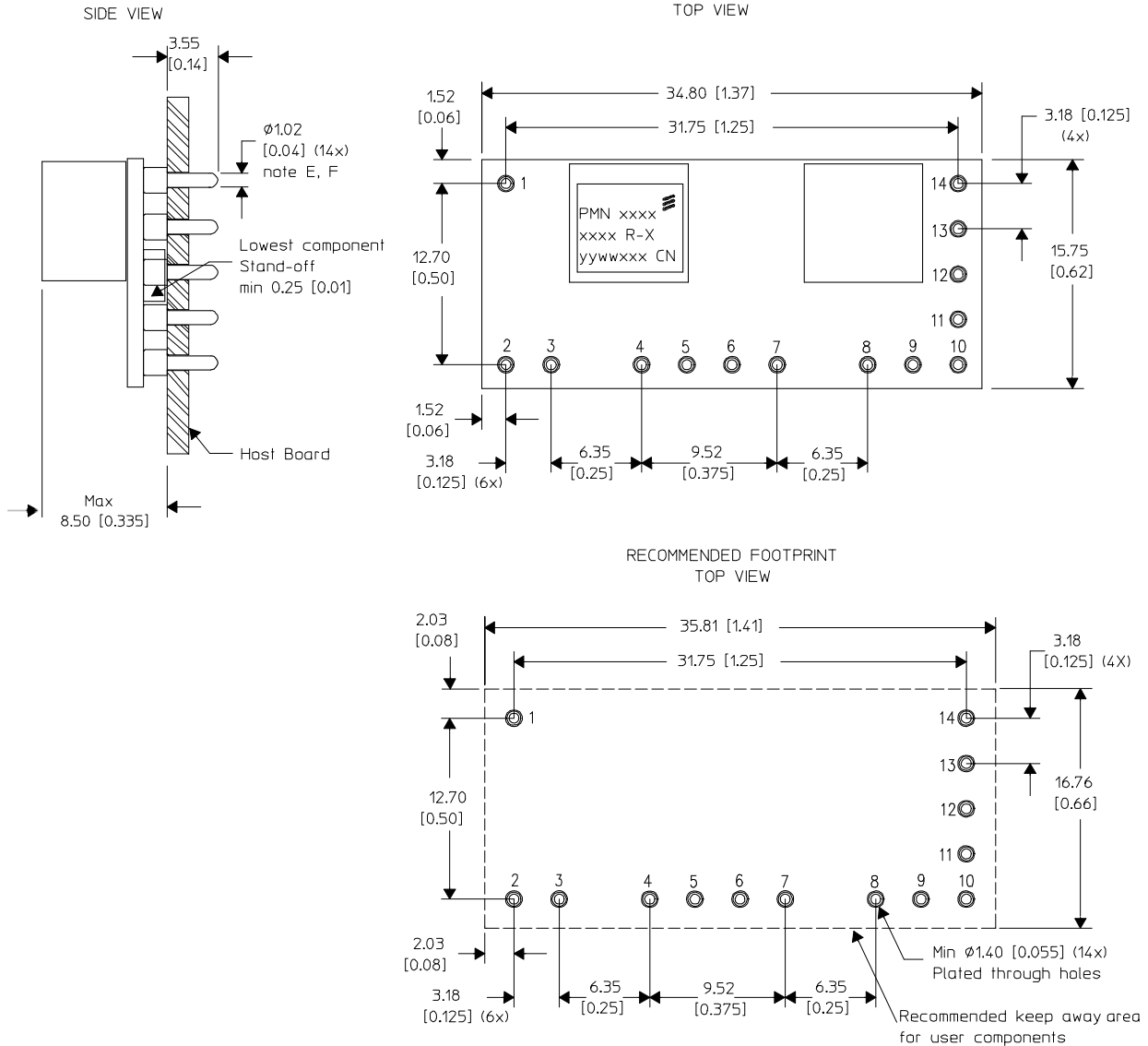

Notes:

- A. All linear dimensions are mm [inch].
- B. This drawing is subject to change without notice.
- C. 1 place decimals are ±0.75 [±0.030]
- D. 2 place decimals are ±0.25 [±0.010]
- E. Pins are $\phi 1.02$ [0.040] with $\phi 1.78$ [0.070] stand-off shoulder.
- F. All pins: Material - Copper Alloy
 Finish - 10 μm Tin over 4 μm Nickel

MECHANICAL DATA FOR THE PMN DC/DC REGULATOR
 Weight: typical 8 g

Use recommended footprint and solder recommendations together with solder reflow recommendations to ensure a reliable interconnection.

PMN 8000 series PoL Regulator
 Input 5.5 - 14 V, Output up to 30 A / 108 W

EN/LZT 146 387 R1B December 2009

© Ericsson AB

Soldering Information - Surface Mounting

The surface mount version of the product is intended for convection or vapor phase reflow SnPb or Pb-free processes. To achieve a good and reliable soldering result, make sure to follow the recommendations from the solder paste supplier, to use state-of-the-art reflow equipment and reflow profiling techniques as well as the following guidelines.

A no-clean flux is recommended to avoid entrapment of cleaning fluids in cavities inside the product or between the product and the host board. The cleaning residues may affect long time reliability and isolation voltage.

Minimum Pin Temperature Recommendations

Pin number 5 is chosen as reference location for the minimum pin temperature recommendations since this will likely be the coolest solder joint during the reflow process.

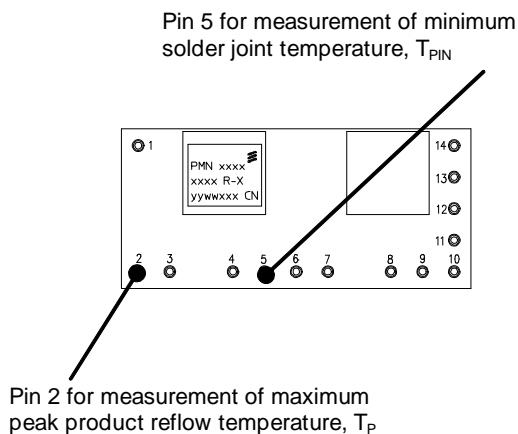

SnPb solder processes

For SnPb solder processes, a pin temperature (T_{PIN}) in excess of the solder melting temperature, (T_L +183°C for Sn63/Pb37) for more than 30 seconds, and a peak temperature of +210°C is recommended to ensure a reliable solder joint.

Lead-free (Pb-free) solder processes

For Pb-free solder processes, a pin temperature (T_{PIN}) in excess of the solder melting temperature (T_L +217 to

+221°C for Sn/Ag/Cu solder alloys) for more than 30 seconds, and a peak temperature of +235°C on all solder joints is recommended to ensure a reliable solder joint.

Peak Product Temperature Requirements

Pin 2 is chosen as reference location for the maximum (peak) allowed product temperature (T_P) since this will likely be the warmest part of the product during the reflow process.

To avoid damage or performance degradation of the product, the reflow profile should be optimized to avoid excessive heating. A sufficiently extended preheat time is recommended to ensure an even temperature across the host PCB, for both small and large devices. To reduce the risk of excessive heating is also recommended to reduce the time in the reflow zone as much as possible.

SnPb solder processes

For SnPb solder processes, the product is qualified for MSL 1 according to IPC/JEDEC standard J-STD-020C.

During reflow, T_P must not exceed +225°C at any time.

Lead-free (Pb-free) solder processes

For Pb-free solder processes, the product is qualified for MSL 3 according to IPC/JEDEC standard J-STD-020C.

During reflow, T_P must not exceed +260°C at any time.

PMN 8000 series PoL Regulator
 Input 5.5 - 14 V, Output up to 30 A / 108 W

EN/LZT 146 387 R1B December 2009

© Ericsson AB

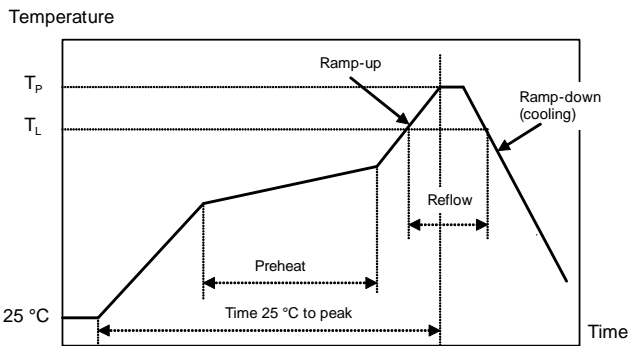

Reflow process specifications		Sn/Pb eutectic	Pb-free
Average ramp-up rate		3 °C/s max	3 °C/s max
Solder melting temperature (typical)	T _L	+183°C	+221°C
Minimum time above T _L		30 s	30 s
Minimum pin temperature	T _{PIN}	+210°C	+235°C
Peak product temperature	T _P	+225°C	+260°C
Average ramp-down rate		6°C/s max	6°C/s max
Time 25 °C to peak		6 minutes max	8 minutes max

PMN 8000 series PoL Regulator
 Input 5.5 - 14 V, Output up to 30 A / 108 W

EN/LZT 146 387 R1B December 2009
 © Ericsson AB

Soldering Information – Through Hole Mounting

The through hole mount version of the product is intended for manual or wave soldering. When wave soldering is used, the temperature on the pins is specified to maximum 270 °C for maximum 10 seconds.

A maximum preheat rate of 4°C/s and a temperature of max of +150°C is suggested. When soldering by hand, care should be taken to avoid direct contact between the hot soldering iron tip and the pins for more than a few seconds in order to prevent overheating.

A no-clean flux is recommended to avoid entrapment of cleaning fluids in cavities inside the product or between the product and the host board. The cleaning residues may affect long time reliability and isolation voltage.

Delivery Package Information

The TH version products are delivered in antistatic trays. The SMD version products are delivered in antistatic trays and antistatic carrier tape (EIA 481 standard).

Tray Specifications	
Material	Antistatic PET
Surface resistance	10 ⁶ < Ohm/square < 10 ¹²
Tray capacity	35 products/tray
Tray thickness	13 mm [0.512 inch]
Box capacity	175 products (5 full trays/box)
Bakability	The tray is not bakable.

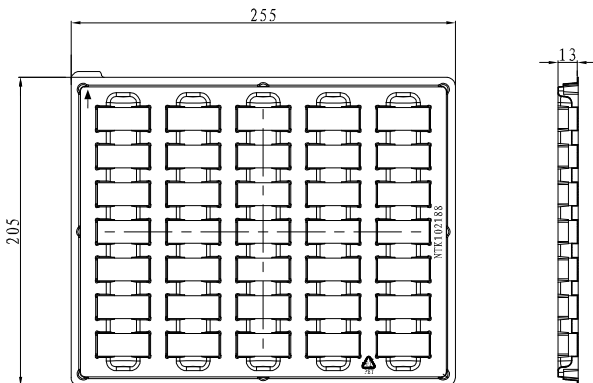

Carrier Tape Specifications	
Material	Antistatic PS
Surface resistance	10 ⁷ < Ohm/square < 10 ¹²
Bakability	The tape is not bakable.
Tape width	56 mm [2.205 inch]
Pocket pitch	24 mm [0.945 inch]
Pocket depth	9.57 mm [0.377 inch]
Reel diameter	381 mm [15 inch]
Reel capacity	250 products /reel

Non-Dry Pack Information

The through hole mount version of product is delivered in non-dry packing trays. The lead (Pb) surface mount version of product is delivered in non-dry packing trays or tape & reel.

Dry Pack Information

The lead free (Pb-free) surface mount version of the product is delivered in trays or tape & reel. These inner shipment containers are dry packed in standard moisture barrier bags according to IPC/JEDEC standard J-STD-033 (Handling, packing, shipping and use of moisture/reflow sensitivity surface mount devices).

Using products in high temperature Pb-free soldering processes requires dry pack storage and handling. In case the products have been stored in an uncontrolled environment and no longer can be considered dry, the modules must be baked according to J-STD-033.

PMN 8000 series PoL Regulator
Input 5.5 - 14 V, Output up to 30 A / 108 W

EN/LZT 146 387 R1B December 2009

© Ericsson AB

Product Qualification Specification

Characteristics			
External visual inspection	IPC-A-610		
Change of temperature (Temperature cycling)	IEC 60068-2-14 Na	Temperature range Number of cycles Dwell/transfer time	-40 to +100 °C 1000 15 min/0-1 min
Cold (in operation)	IEC 60068-2-1 Ad	Temperature T _A Duration	-45°C 72 h
Damp heat	IEC 60068-2-67 Cy	Temperature Humidity Duration	+85 °C 85 % RH 1000 hours
Dry heat	IEC 60068-2-2 Bd	Temperature Duration	+125 °C 1000 h
Immersion in cleaning solvents	IEC 60068-2-45 XA Method 2	Water Glycol ether	+55° C +35° C
Mechanical shock	IEC 60068-2-27 Ea	Peak acceleration Duration	100 g 6 ms
Moisture reflow sensitivity ¹	J-STD-020C	level 1 (SnPb-eutectic) level 3 (Pb Free)	225° C 260° C
Operational life test	MIL-STD-202G method 108A	Duration	1000 h
Resistance to soldering heat ²	IEC 60068-2-20 Tb Method 1A	Solder temperature Duration	270° C 10-13 s
Robustness of terminations	IEC 60068-2-21 Test Ua1 IEC 60068-2-21 Test Ue1	Through hole mount products Surface mount products	All leads All leads
Solderability	IEC 60068-2-58 test Td ¹ IEC 60068-2-20 test Ta ²	Preconditioning Temperature, SnPb Eutectic Temperature, Pb-free Preconditioning Temperature, SnPb Eutectic Temperature, Pb-free	150 °C dry bake 16 h 215° C 235° C Steam ageing 235 ° C 245 ° C
Vibration, broad band random	IEC 60068-2-64 Fh, method 1	Frequency Spectral density Duration	10 to 500 Hz 0.07 g ² /Hz 10 min in each perpendicular direction

Note 1: Only for products intended for reflow soldering (surface mount products)

Note 2: Only for products intended for wave soldering (plated through hole products)

X-ON Electronics

Largest Supplier of Electrical and Electronic Components

Click to view similar products for [Non-Isolated DC/DC Converters](#) category:

Click to view products by [Ericsson](#) manufacturer:

Other Similar products are found below :

[PSR152.5-7IR](#) [APTH003A0X-SRZ](#) [SPM1004-3V3C](#) [R-785.0-05](#) [10E24-P15-10PPM](#) [1E24-P4-25PPM-SHV-5KV](#) [CA-17205-L4](#)
[PROPOWER-3.3V](#) [MYGTM01210BZN](#) [JRCS016A0S4-HZ](#) [3V12-N0.8](#) [6AA24-P30-I5-M](#) [BM2P101X-Z](#) [ROF-78E12-0.5SMD-R](#)
[RPMA5.0-8.0/OF](#) [RPX-4.0-CT](#) [PTV03010WAD](#) [PTV05020WAH](#) [PTV12010LAH](#) [PTV12020WAD](#) [R-7212D](#) [R-7212P](#) [R-78AA5.0-](#)
[1.0SMD](#) [30A24-N15-E](#) [10A12-P4-M](#) [10C24-N250-I5](#) [10C24-P125](#) [10C24-P250-I5](#) [6A24-P20-I10-F-M-25PPM](#) [1A24-P30-F-M-C](#) [TSR 1-](#)
[24150SM](#) [1/2AA24-N30-I10](#) [1C24-N125](#) [12C24-N250](#) [V7806-1500](#) [PTV05010WAH](#) [PTN04050CAZT](#) [PTH12020WAD](#) [PTH12020LAS](#)
[PTH05T210WAH](#) [V7803-2000R](#) [AXA005A0XZ](#) [NSR020A0X43Z](#) [TPS82677SIPR](#) [OKR-T/30-W12-C](#) [NID30S24-15](#) [NID30S48-24](#)
[LXDC2HL25A-053](#) [LXDC2HL10A-080](#) [PTH05T210WAD](#)