



# PCI Express Right Angle Connector System



# PCI Express Right Angle Connector System

## Table of Contents



General ..... 2  
Features ..... 2  
Electrical and Mechanical Characteristics ..... 3  
X1 36 Pin..... 4, 5  
X4 64 Pin..... 6, 7  
X8 98 Pin..... 8, 9  
X16 164 Pin..... 10, 11  
Part Number Index ..... 12

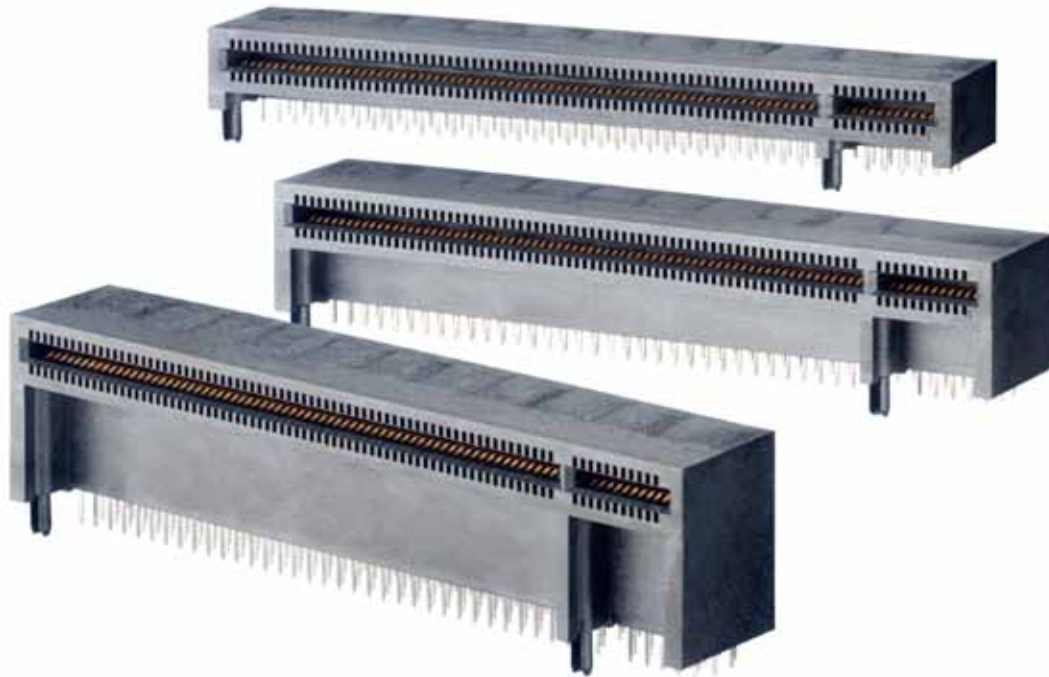

## General

The PCI Express (PCIe) Architecture was introduced into the market place in 2004 as a result of OEMs, including Intel, working together to design a next generation Bus Architecture. The current PCI Bus protocol has evolved from a 32 Bit PCI to 64 Bit PCI, PCI-X, causing the industry's demand for greater speeds to outstrip the capabilities of PCI. The development of the PCIe protocol has allowed the industry to embrace a new bus architecture that will handle the demands for the next 10 years. Completely compatible with PCI, the PCIe will allow designers greater flexibility when designing new systems and upgrading existing systems.

The ERNI Right Angle PCIe connector's footprint is identical to the standard vertical mount configuration. The connector pins are insert molded into the connector to allow for exact registration of the contacts on both the daughter card side and the board mount thru hole side. The connector itself is molded out of a high temperature plastic. This allows the connector to withstand the higher reflow and IR temperatures required for processing lead free components. The overall rugged construction of this connector is fabricated with the best materials available for the application requirements. The Right Angle design of the connector will enable the engineer to consider more options while designing the product where height is at premium.

## Features

- Angled PCIe connector allows the system designer to solve space problems that cannot be solved with vertical PCIe connectors
- Connector enables the add-on card to be mounted parallel to the motherboard, saving space in the overall height of the computer box
- Available in X1, X4, X8 or X16 versions in stack heights of 5.84mm, 11.18mm, and 16.69mm
- Meets all PCIe Local Bus Standards Rev. 2.0
- Plastic cover protects connector from dust and debris
- Insert molded with liquid crystal polymer to provide stability in hybrid board applications involving SMCs
- Compatible with wave soldering process

# PCI Express Right Angle Connector System

## Electrical and Mechanical Characteristics



	Standard	Right Angle Edge Card Connector
Number of Pins		X1=36 X4=64 X8=98 X16=164
<b>Process-conditions</b>		
Dip soldering temperature max.	IEC 68-2-20	10s at 260 °C
Reflow soldering temperature max.	JEDEC J-STD-020C	20-90s at 260 °C
<b>Housing Materials</b>		
Plastic material		LCP 30% glass-filled
UL flame rating		UL 94 V-0
<b>Contact Materials</b>		
Base material		Cu alloy
Mating area		Gold Flash over Ni
Termination area		Gold Flash over Ni
Marking		
<b>Technical Data</b>		
Temperature range		-40 to +105°C
Current rating		1.1 A continuous
Voltage rating		max 300 V
Dielectric strength		>500 VAC at 60 Hz
Conductor resistance		<40 mΩ
Insulation resistance		>1 x 10 <sup>9</sup> Ω at 500 VDC
Capacitance at 1 kHz		As advertised
Inductance at 10 kHz		As advertised
Impedance		As advertised
Crosstalk		Next >30 dB at 2.0 GHz
Propagation delay		As advertised
<b>Insertion Loss</b> (for connectors with Dim. B = 5.84 mm)		<1 dB at 1.0 GHz <3 dB at 2.5 GHz
<b>Return Loss</b> (for connectors with Dim. B = 5.84 mm)		>12 dB at 1.25 GHz >7 dB at 1.5 GHz >4 dB at 2.0 GHz
<b>Product-approval</b>		
UL		In Preparation
CSA		In Preparation

# PCI Express Right Angle Connector System

## X1 Link Width, 36 pin



### Dimensional Drawings

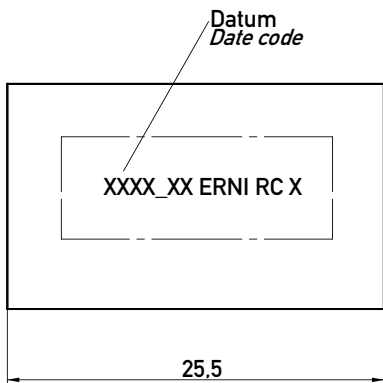
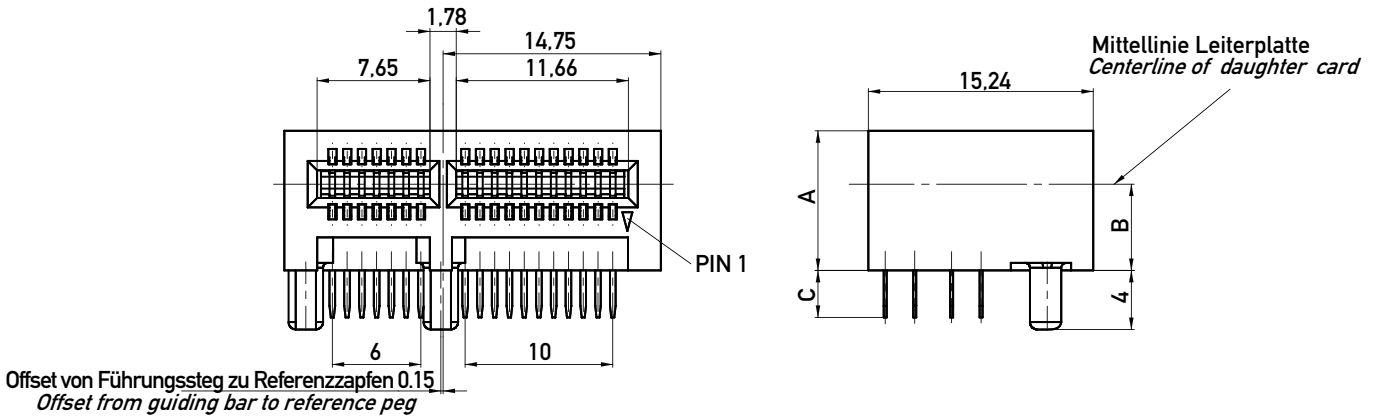

Lochbild für Leiterplatte (Bestückungsseite)  
Board hole pattern (component mounting side)

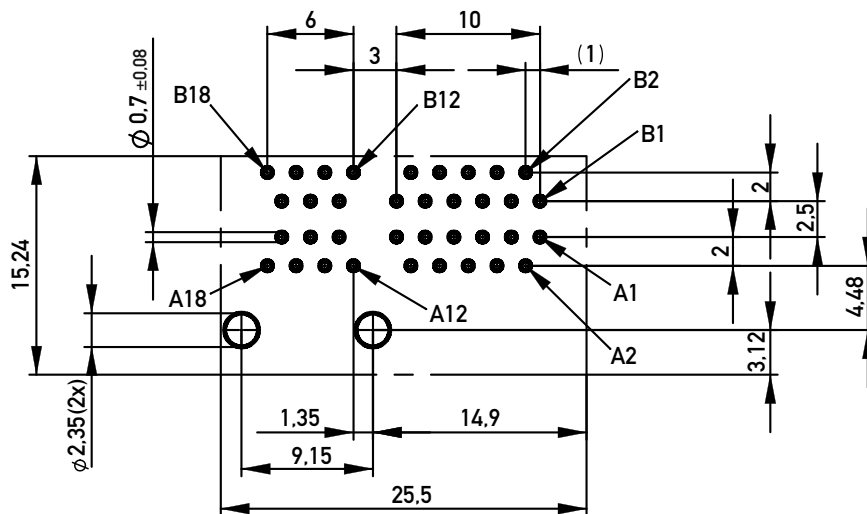

All dimensions in mm.

All images in first angle projection

# PCI Express Right Angle Connector System

## X1 Link Width, 36 pin



### Ordering Information

Dim. A	Dim. B	Dim. C	No. of Pins	Termination	Packaging	Part Number
9.4 mm	5.84 mm	2.54 mm	36	Solder	Tray/20pcs	<b>009000</b>

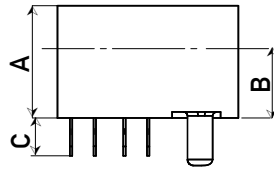
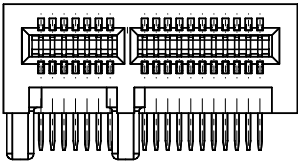

14.7 mm	11.18 mm	2.54 mm	36	Solder	Tray/20pcs	<b>009001</b>
---------	----------	---------	----	--------	------------	---------------

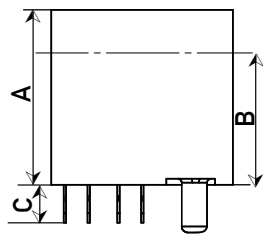
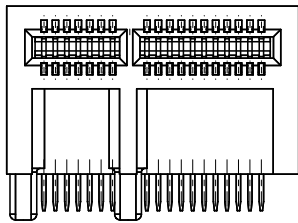

20.3 mm	16.69 mm	2.54 mm	36	Solder	Tray/20pcs	<b>009002</b>
---------	----------	---------	----	--------	------------	---------------

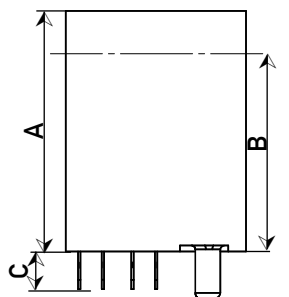
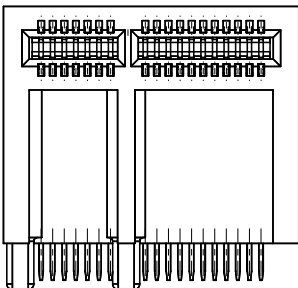

# PCI Express Right Angle Connector System

X4 Link Width, 64 pin



## Dimensional Drawings

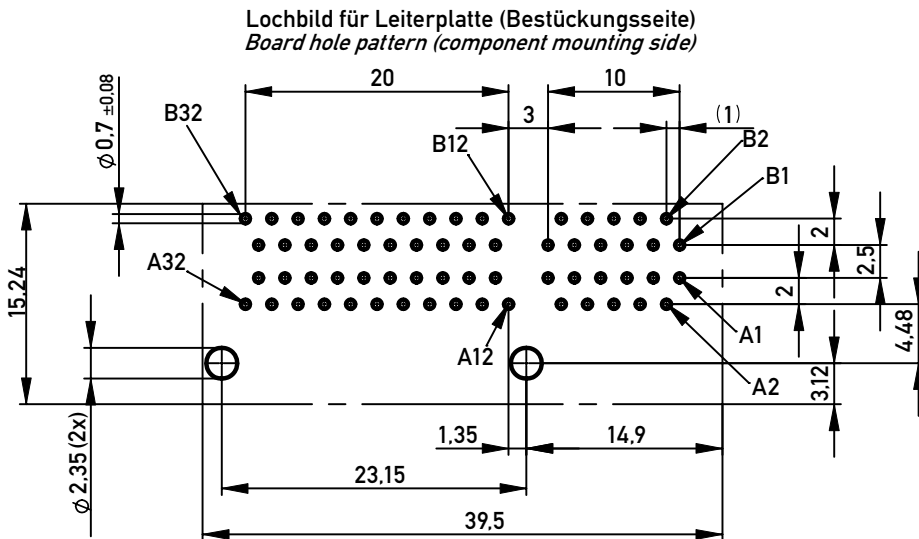
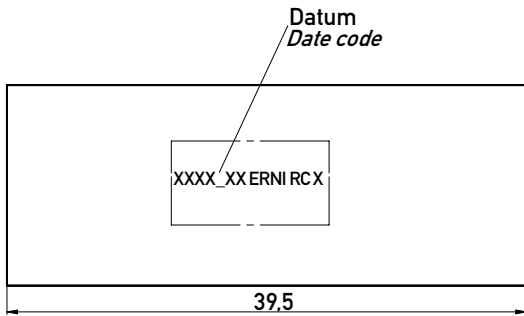
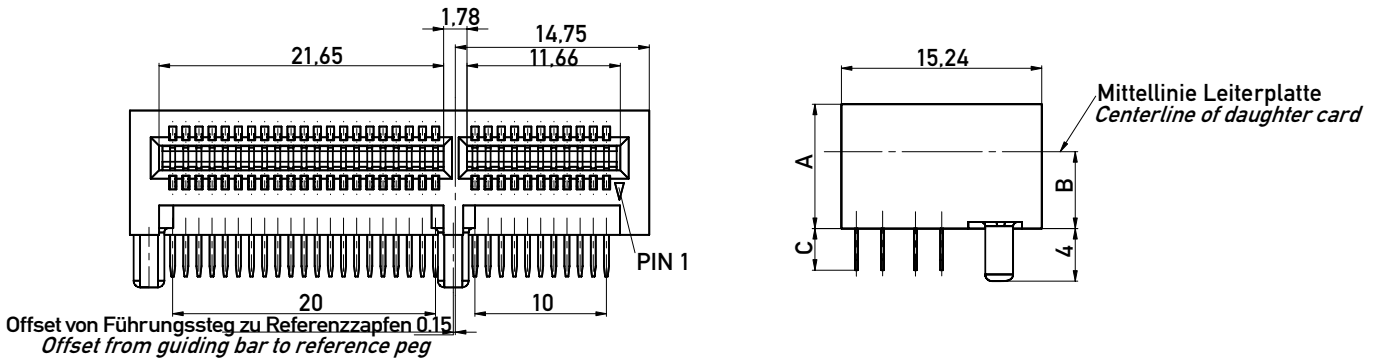

All dimensions in mm.

All images in first angle projection



# PCI Express Right Angle Connector System

## X4 Link Width, 64 pin



### Ordering Information

Dim. A	Dim. B	Dim. C	No. of Pins	Termination	Packaging	Part Number
9.4 mm	5.84 mm	2.54 mm	64	Solder	Tray/20pcs	009003

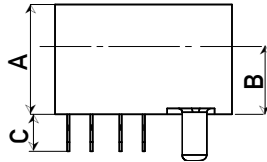
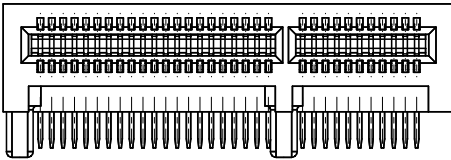

14.7 mm	11.18 mm	2.54 mm	64	Solder	Tray/20pcs	009004
---------	----------	---------	----	--------	------------	--------

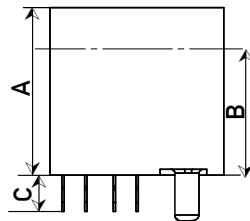
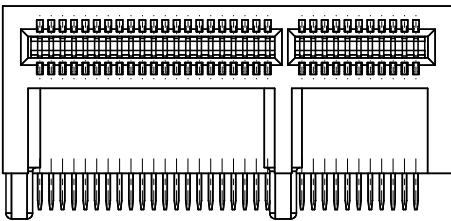

20.3 mm	16.69 mm	2.54 mm	64	Solder	Tray/20pcs	009005
---------	----------	---------	----	--------	------------	--------

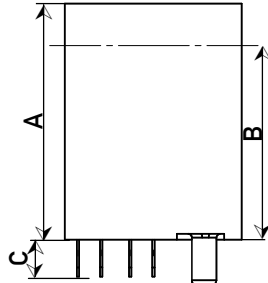
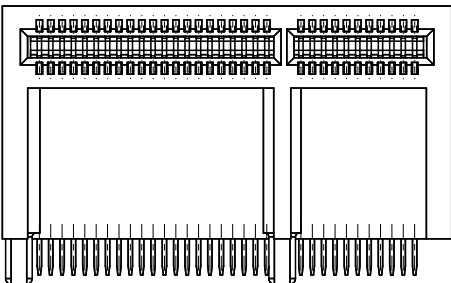

# PCI Express Right Angle Connector System

X8 Link Width, 98 pin



## Dimensional Drawings

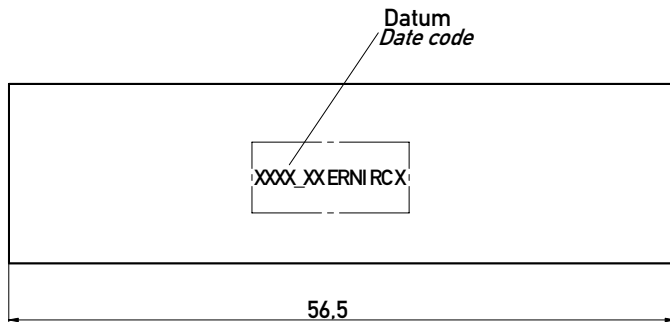
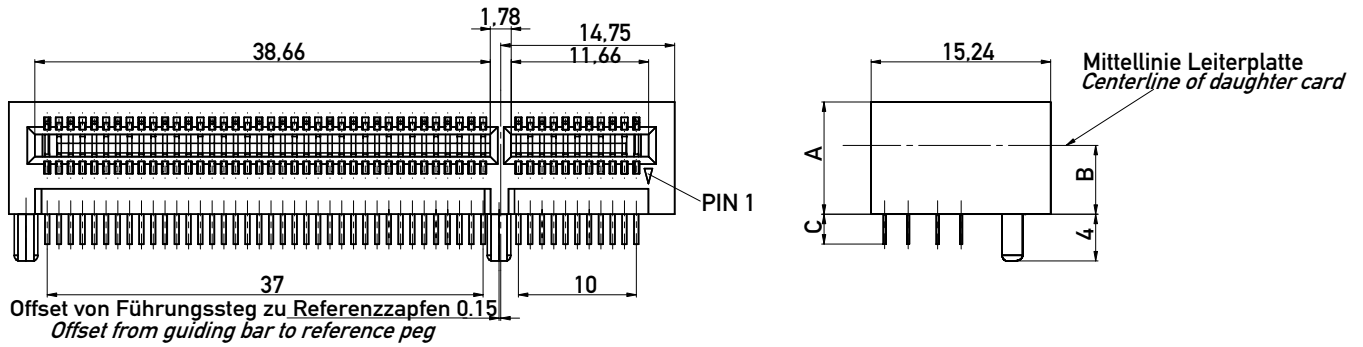

Lochbild für Leiterplatte (Bestückungsseite)  
Board hole pattern (component mounting side)

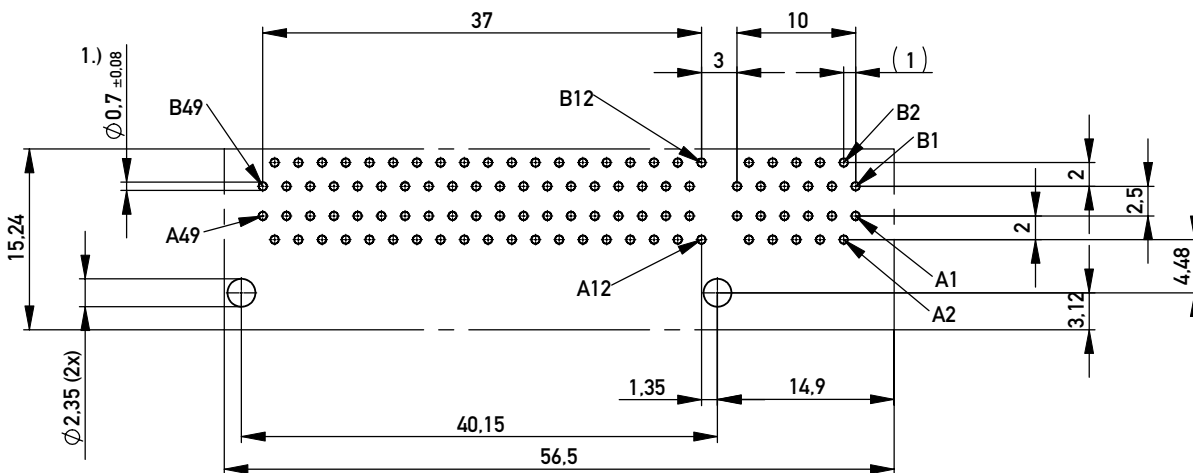

All dimensions in mm.

All images in first angle projection

# PCI Express Right Angle Connector System

X8 Link Width, 98 pin



## Ordering Information

Dim. A	Dim. B	Dim. C	No. of Pins	Termination	Packaging	Part Number
9.4 mm	5.84 mm	2.54 mm	98	Solder	Tray/20pcs	009006

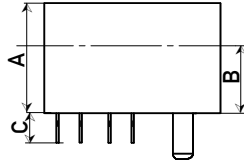
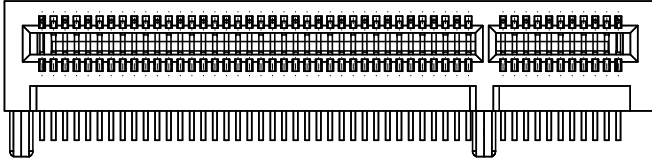

14.7 mm	11.18 mm	2.54 mm	98	Solder	Tray/20pcs	009007
---------	----------	---------	----	--------	------------	--------

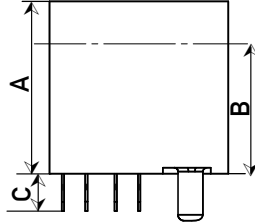
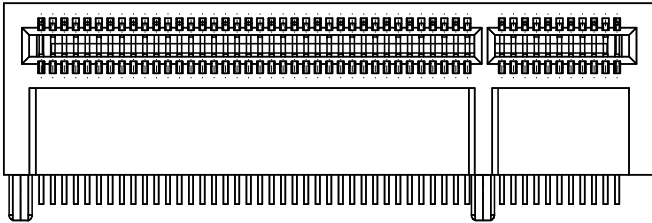

20.3 mm	16.69 mm	2.54 mm	98	Solder	Tray/20pcs	009008
---------	----------	---------	----	--------	------------	--------

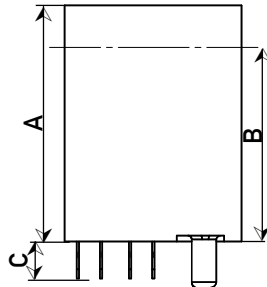
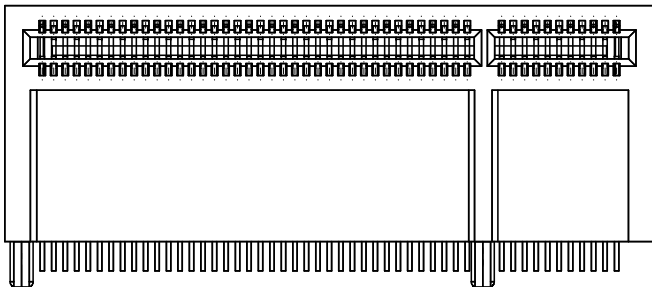

# PCI Express Right Angle Connector System

X16 Link Width, 164 pin



## Dimensional Drawings

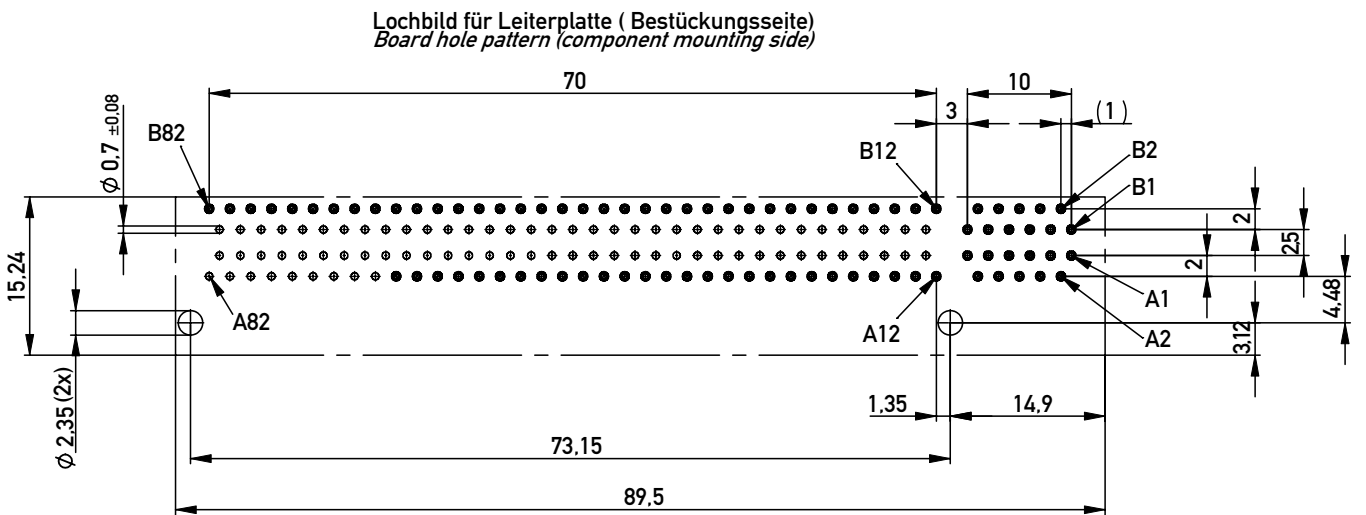
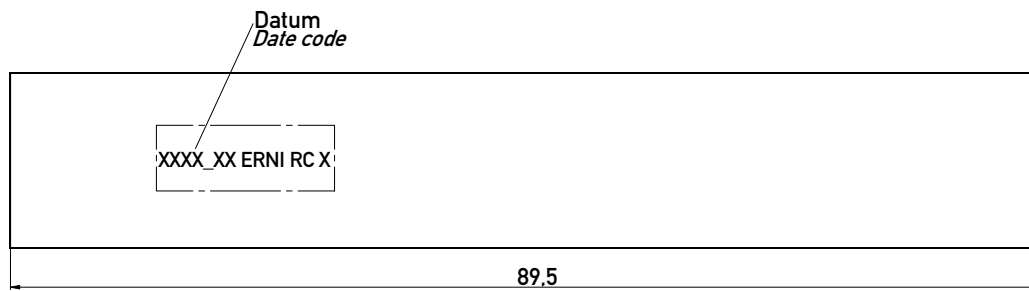
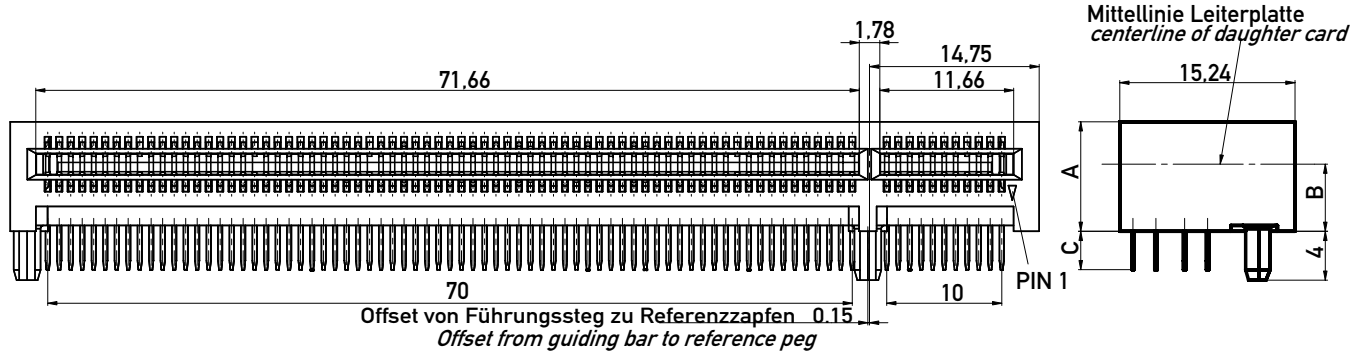

All dimensions in mm.

All images in first angle projection

# PCI Express Right Angle Connector System

X16 Link Width, 164 pin



## Ordering Information

Dim. A	Dim. B	Dim. C	No. of Pins	Termination	Packaging	Part Number
9.4 mm	5.84 mm	2.54 mm	164	Solder	Tray/20pcs	009009

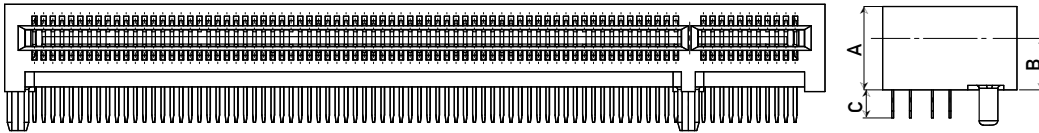

14.7 mm	11.18 mm	2.54 mm	164	Solder	Tray/20pcs	009010
---------	----------	---------	-----	--------	------------	--------

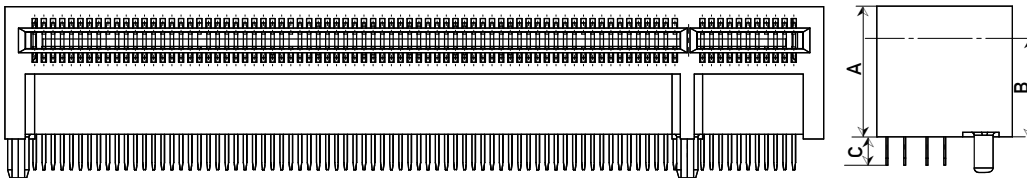

20.3 mm	16.69 mm	2.54 mm	164	Solder	Tray/20pcs	009011
---------	----------	---------	-----	--------	------------	--------

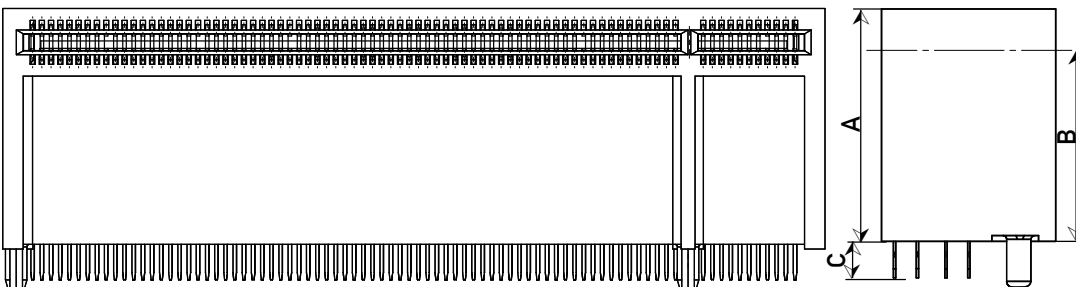

# PCI Express Right Angle Connector System

## Part Number Index



Part Number	Page
009000 .....	4, 5
009001 .....	4, 5
009002 .....	4, 5
009003 .....	6, 7
009004 .....	6, 7
009005 .....	6, 7
009006 .....	8, 9
009007 .....	8, 9
009008 .....	8, 9
009009 .....	10, 11
009010 .....	10, 11
009011 .....	10, 11





**ERNI Electronics GmbH**

Seestrasse 9  
73099 Adelberg/Germany  
Tel +49 7166 50-0  
Fax +49 7166 50-282  
info@erni.de

Europe South America Africa Japan

**ERNI Electronics, Inc.**

2201 Westwood Ave  
Richmond, VA 23230/USA  
Tel +1 804 228-4100  
Fax +1 804 228-4099  
info.usa@erni.com

North America Canada Mexico

**ERNI Asia Holding Pte Ltd.**

Blk 4008 Ang Mo Kio Avenue 10  
#04-01/02 Techplace I  
Singapore 569625  
Tel +65 6 555 5885  
Fax +65 6 555 5995  
info@erni-asia.com

Asia

[www.erni.com](http://www.erni.com)

© ERNI Electronics GmbH 2008 • Printed in Germany. A policy of continuous improvement is followed and the right to alter any published data without notice is reserved. ERNI<sup>®</sup>, MicroStac<sup>®</sup>, MicroSpeed<sup>®</sup>, MiniBridge<sup>®</sup>, MaxiBridge<sup>®</sup>, ERmet<sup>®</sup>, ERmet ZD<sup>®</sup>, ERbic<sup>®</sup> and ERNIPRESS<sup>®</sup> are trademarks (registered or applied for in various countries) of ERNI Electronics GmbH.



## X-ON Electronics

Largest Supplier of Electrical and Electronic Components

*Click to view similar products for [PCI Express/PCI Connectors](#) category:*

*Click to view products by [ERNI](#) manufacturer:*

Other Similar products are found below :

[UEX220-6U](#) [10039755-10110TLF](#) [1-1871239-2](#) [2170560-2](#) [10125756-980000LF](#) [EB220-3U](#) [10061913-120PLF](#) [GPCP146400111HR](#)  
[GPCP442628110HR](#) [GPCP446200120HR](#) [GPCP245400111HR](#) [10082378-10000TLF](#) [87715-9256](#) [MDT580M03001](#) [0877159107](#)  
[MDT580M01001](#) [10018783-11000MLF](#) [10018783-11101TLF](#) [10108777-10000ALF](#) [10141523-111T0LF](#) [10145445-10003MLF](#)  
[PSASF2130311TR](#) [PSASF3130411TR](#) [7-1734774-7](#) [3-1761465-1](#) [10018784-10111TLF](#) [10039755-10111TLF](#) [10039755-10112TLF](#)  
[10018783-10211TLF](#) [10018784-10211TLF](#) [10018784-10212TLF](#) [1761465-2](#) [1871058-1](#) [5-1761465-4](#) [10018783-10200MLF](#) [10018783-](#)  
[10213TLF](#) [10018784-10210TLF](#) [10018784-11113TLF](#) [10025026-10001TLF](#) [5145154-8](#) [1871058-4](#) [2041119-2](#) [10018783-10212TLF](#)  
[10018784-10102TLF](#) [10018783-11200TLF](#) [SM3ZS067U215-NUT1-R2500](#) [10123371-001TRLF](#) [10018784-10110TLF](#) [6-1734774-7](#) [6-](#)  
[1734774-9](#)