

Mutter / nut

Bolzen / bolt

Gewinde / thread
M3 / #4-40

ohne / without

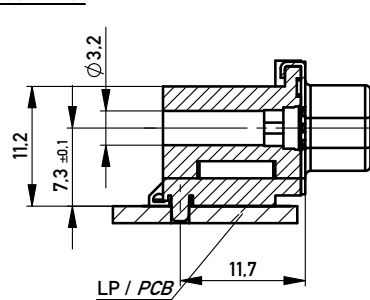
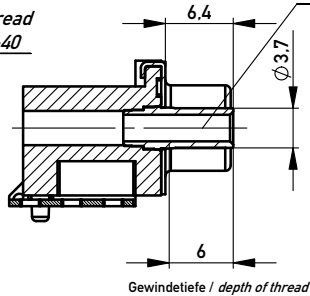
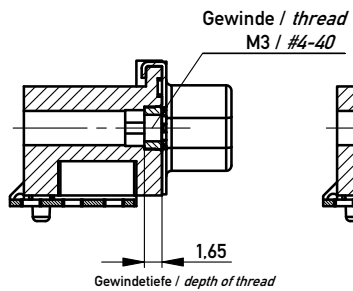

Anschlussbereich verzinnt
terminal area tin plating

Koplanarität der Anschlüsse ≤ 0.1 mm
coplanarity area of termination ≤ 0.1 mm

Anforderungsstufe: 2
class: 2

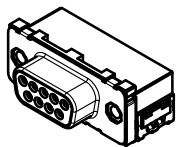

234939	174440	Ø3.2			
174988	154238			#4-40	
	154237			M3	
214560	154236	#4-40			
	154235	M3			
Ident-Nr. part-no. Gurt tape on reel	Ident-Nr. part-no. Tray tray	ohne without	Mutter nut	Bolzen bolt	Bemerkung remark

Verpackt in Tray
Verpackungseinheit 32 Stück
tray packaging
packaging unit 32 pcs

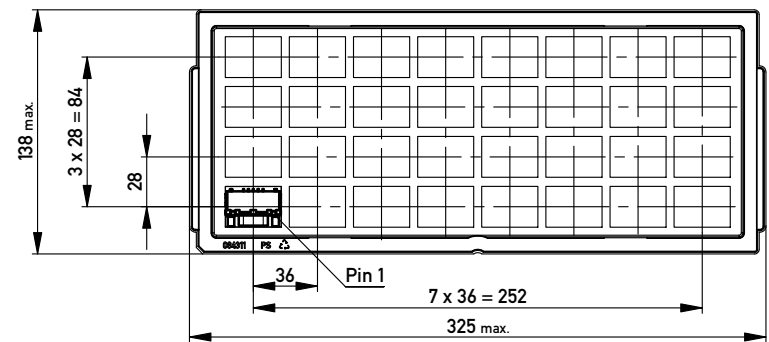

Sonstige Angaben siehe Zeichnung 204629 / additional indications according to drawing 204629

Verpackt in Gurtverpackung - Tape on Reel Packaging
Verpackungseinheit: 75 Stück - Packaging unit: 75 pcs

Abspulrichtung - Reel off Direction

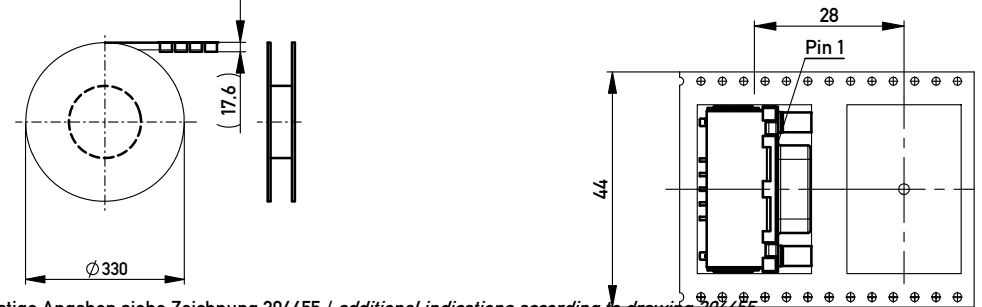

Sonstige Angaben siehe Zeichnung 204655 / additional indications according to drawing 204655

Layoutvorschlag
recommended layout

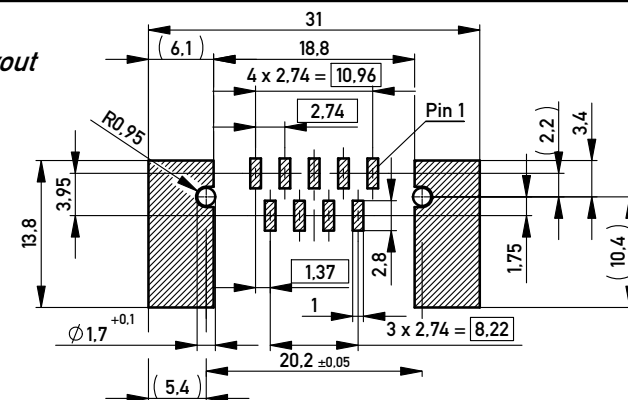

Fehlende Masse und Angaben siehe DIN 41652 / Missing information and dimensions according to DIN 41652
Sonstige Angaben siehe Fertigungsunterlagen / Additional indications according to production documentation

Information: All rights reserved. Only for Information. To ensure that this is the latest version of this drawing, please contact one of the ERNI companies before using.	Tolerances	Scale 2:1 All Dimensions in mm	Designation TMC-S-09-SMD-Standard-BA8 <i>TMC-S-09-SMD-Standard-BA8</i>
	Subject to modification without prior notice. Drawing will not be updated.		
Copyright by ERNI GmbH Proprietary notice pursuant to ISO 9006 to be observed.	www.ERNI.com	144839	I A3
t Index	21.11.2011 Date	Class	TMCS

X-ON Electronics

Largest Supplier of Electrical and Electronic Components

Click to view similar products for [D-Sub Standard Connectors](#) category:

Click to view products by [ERNI](#) manufacturer:

Other Similar products are found below :

[56F711-015](#) [012-9507-004](#) [LV242999-142T12](#) [015-0341-000](#) [015-0349-000](#) [015-0372-005](#) [015-0372-008](#) [015-8755-001](#) [020419-0104](#) [012-0467-000](#) [012-0515-000](#) [012-9507-034](#) [012-9507-114](#) [020745-0008](#) [609-25P](#) [M24308/2-23Z](#) [CT2-14S-2PCA34](#) [CT2-18-11PCAU](#) [CT2-36-15SC](#) [CT6-14S-2SC](#) [CT6E14SA7SC](#) [CT6E22-14PC](#) [CT6E22-14PS](#) [CT6E22-22PS](#) [M83513/01-FC](#) [M85049/48-3-2F](#) [6STD09PCM99B70X](#) [6STD09SCM99B30X](#) [6STD09SCT99S40X](#) [6STD15PCT99S40X](#) [6STD15SCM99B30X](#) [6STD15SCT99S40X](#) [6STF09PCM05B70X](#) [7-135760-9](#) [MC11E-10-6SN](#) [747552-3](#) [MD1-21PS](#) [MDM-15SCBRM7-F222](#) [MDM96517-699](#) [MDM96521-744](#) [MDVB1-21SL1](#) [MIK0-1-7SH003](#) [MIKQ6-7SH076](#) [MIKQ7-7PH077](#) [MIKQ7-7PH11](#) [MIKQ7-7PH32](#) [MIKQ9-7PH003](#) [MJSV-28SL61](#) [MKJ4A1F14-55S](#) [8-135760-3](#)