

Mutter / nut

Bolzen / bolt

Gewinde / thread  
M3 / #4-40

ohne / without

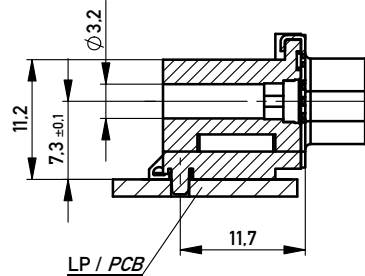
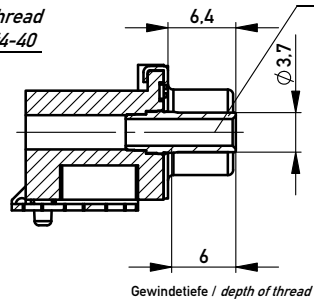
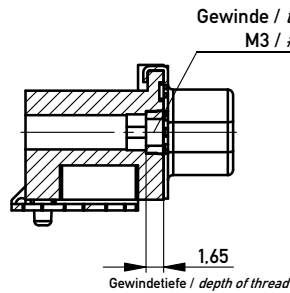

Anschlussbereich verzinnt  
terminal area tin plating

Koplanarität der Anschlüsse  $\leq 0.1$  mm  
coplanarity area of termination  $\leq 0.1$  mm

Anforderungsstufe: 2  
class: 2

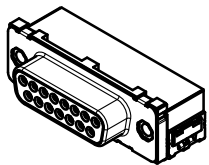

394045	174441	Ø3.2			
174989	154242			#4-40	
	154241			M3	
225034	154240		#4-40		
394982	154239		M3		
Ident-Nr. part-no. Gurt tape on reel	Ident-Nr. part-no. Tray tray	ohne without	Mutter nut	Bolzen bolt	Bemerkung remark

Verpackt in Tray  
Verpackungseinheit 24 Stück  
tray packaging  
packaging unit 24

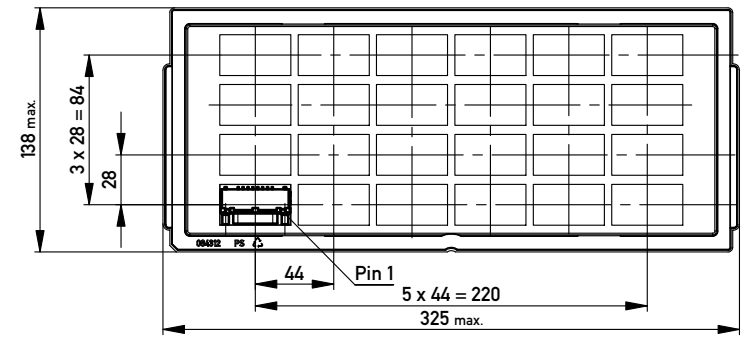

Sonstige Angaben siehe Zeichnung 204629 / additional indications according to drawing 204629

Verpackt in Gurtverpackung - Tape on Reel Packaging  
Verpackungseinheit: 75 Stück - Packaging unit: 75 pcs

Abspulrichtung - Reel off Direction

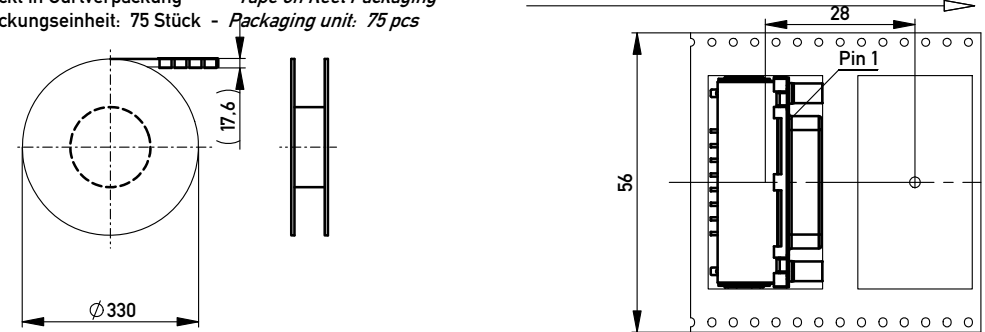

Sonstige Angaben siehe Zeichnung 204655 / additional indications according to drawing 204655

Layoutvorschlag  
recommended layout

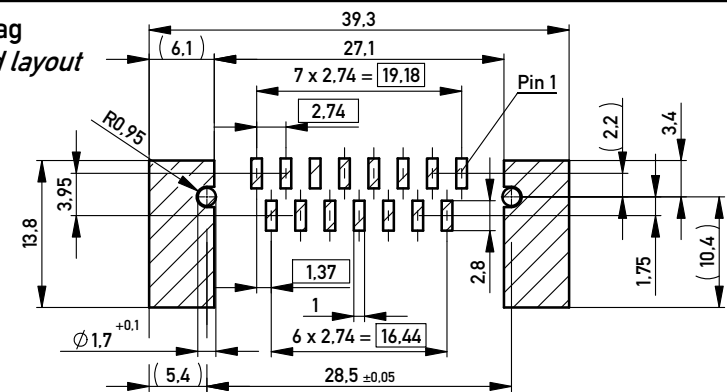

Fehlende Masse und Angaben siehe DIN 41652 / Missing information and dimensions according to DIN 41652  
Sonstige Angaben siehe Fertigungsunterlagen / Additional indications according to production documentation

Information:  All rights reserved. Only for Information. To ensure that this is the latest version of this drawing, please contact one of the ERNI companies before using.	Tolerances	 All Dimensions in mm	Scale 2:1
	Designation <b>TMC-S-15-SMD-Standard-BA8</b> <i>TMC-S-15-SMD-Standard-BA8</i>		
www.ERNI.com	<b>144840</b>		I
	m Index	07.12.2011 Date	Class TMCS

## X-ON Electronics

Largest Supplier of Electrical and Electronic Components

*Click to view similar products for [D-Sub Standard Connectors](#) category:*

*Click to view products by [ERNI](#) manufacturer:*

Other Similar products are found below :

[56F711-015](#) [012-9507-004](#) [LV242999-142T12](#) [015-0341-000](#) [015-0349-000](#) [015-0372-005](#) [015-0372-008](#) [015-8755-001](#) [020419-0104](#) [012-0467-000](#) [012-0515-000](#) [012-9507-034](#) [012-9507-114](#) [020745-0008](#) [609-25P](#) [M24308/2-23Z](#) [CT2-14S-2PCA34](#) [CT2-18-11PCAU](#) [CT2-36-15SC](#) [CT6-14S-2SC](#) [CT6E14SA7SC](#) [CT6E22-14PC](#) [CT6E22-14PS](#) [CT6E22-22PS](#) [M83513/01-FC](#) [M85049/48-3-2F](#) [6STD09PCM99B70X](#) [6STD09SCM99B30X](#) [6STD09SCT99S40X](#) [6STD15PCT99S40X](#) [6STD15SCM99B30X](#) [6STD15SCT99S40X](#) [6STF09PCM05B70X](#) [7-135760-9](#) [MC11E-10-6SN](#) [747552-3](#) [MD1-21PS](#) [MDM-15SCBRM7-F222](#) [MDM96517-699](#) [MDM96521-744](#) [MDVB1-21SL1](#) [MIK0-1-7SH003](#) [MIKQ6-7SH076](#) [MIKQ7-7PH077](#) [MIKQ7-7PH11](#) [MIKQ7-7PH32](#) [MIKQ9-7PH003](#) [MJSV-28SL61](#) [MKJ4A1F14-55S](#) [8-135760-3](#)