

Verpackt in Tray  
Verpackungseinheit 24 St.  
tray packaging  
packaging unit 24 pcs

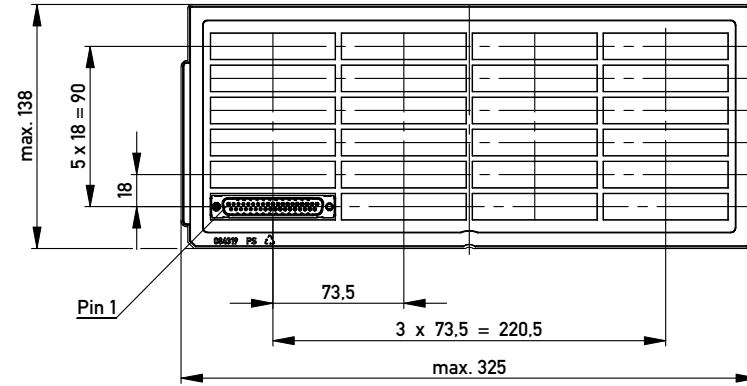
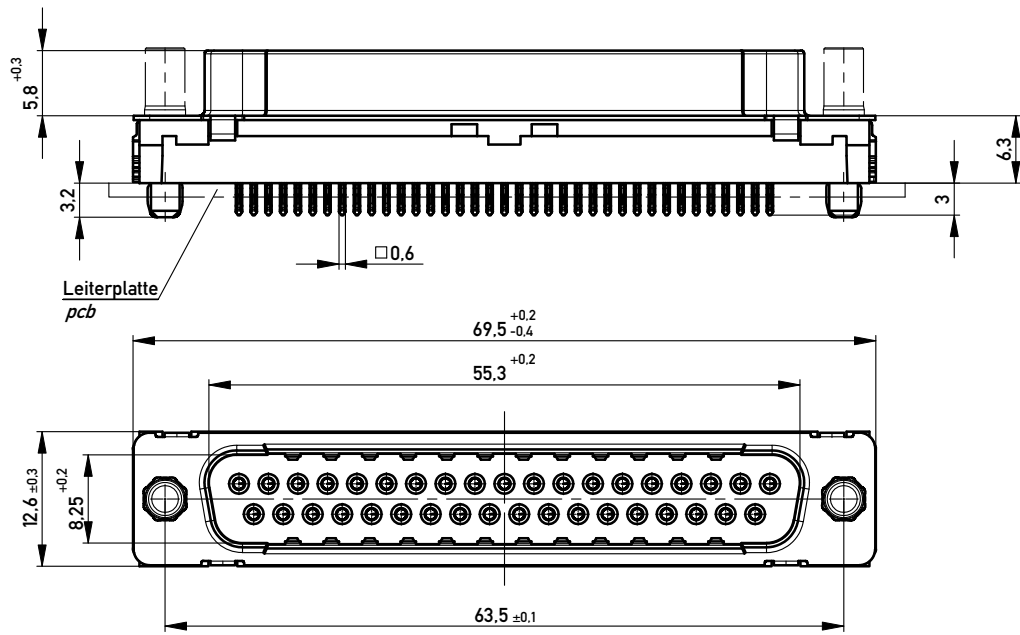

Sonstige Angaben siehe Zeichnung 204628 / Additional indications according to drawing 204628

ohne / without

Mutter / nut  
max. Einschraubtiefe 3.7 mm  
thread depth max. 3.7 mm

Bolzen / bolt  
max. Einschraubtiefe 5.5 mm  
thread depth max. 5.5 mm

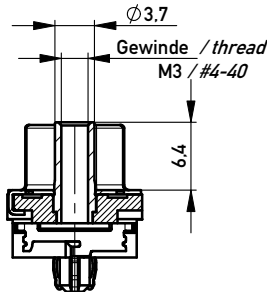
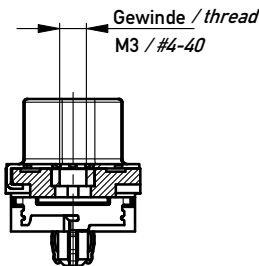
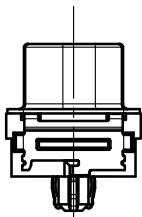

M 1:1

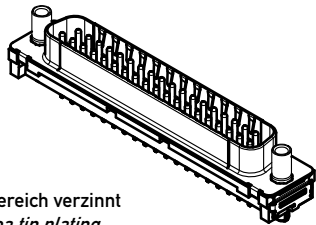

Anschlussbereich verzinkt  
terminal area tin plating

Anforderungsstufe: 2  
class: 2

Beschriftung nach Bedruckungsvorschrift 174538  
Part marking according to specification 174538

194113	X			
194117			#4-40	
194116			M3	
194115		#4-40		
194114		M3		
Ident.-Nr. part-no.	ohne without	Mutter thread	Bolzen bolt	Bemerkung remark

Layoutvorschlag:  
recommended layout:

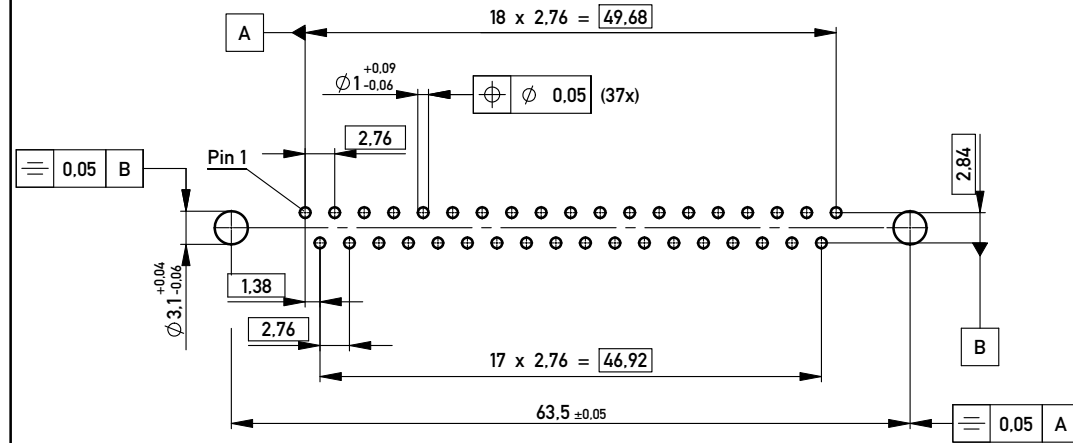

Lochlaufbau siehe ERNI-Spezifikation 164062 / hole design according to ERNI-specification 164062

Fehlende Masse und Angaben siehe DIN 41652 / Missing information and dimensions according to DIN 41652  
Sonstige Angaben siehe Fertigungsunterlagen / Additional indications according to the production documentation

Information:		Tolerances	Scale 2:1
All rights reserved. Only for Information. To ensure that this is the latest version of this drawing, please contact one of the ERNI companies before using.		 All Dimensions in mm	Designation <b>TMC-P 37-EE-3.0-6.3-BA8</b> <b>TMC-P 37-EE-3.0-6.3-type 8</b>
A	02.03.2010	Class TMCP	
Index	Date	I A3	

Copyright by ERNI GmbH  
Proprietary notice pursuant to ISO 16016 to be observed.

## X-ON Electronics

Largest Supplier of Electrical and Electronic Components

*Click to view similar products for [D-Sub Standard Connectors](#) category:*

*Click to view products by [ERNI](#) manufacturer:*

Other Similar products are found below :

[56F711-015](#) [012-9507-004](#) [LV242999-142T12](#) [015-0341-000](#) [015-0349-000](#) [015-0372-005](#) [015-0372-008](#) [015-8755-001](#) [020419-0104](#) [012-0467-000](#) [012-0515-000](#) [012-9507-034](#) [012-9507-114](#) [020745-0008](#) [609-25P](#) [M24308/2-23Z](#) [CT2-14S-2PCA34](#) [CT2-18-11PCAU](#) [CT2-36-15SC](#) [CT6-14S-2SC](#) [CT6E14SA7SC](#) [CT6E22-14PC](#) [CT6E22-14PS](#) [CT6E22-22PS](#) [M83513/01-FC](#) [M85049/48-3-2F](#) [6STD09PCM99B70X](#) [6STD09SCM99B30X](#) [6STD09SCT99S40X](#) [6STD15PCT99S40X](#) [6STD15SCM99B30X](#) [6STD15SCT99S40X](#) [6STF09PCM05B70X](#) [7-135760-9](#) [MC11E-10-6SN](#) [747552-3](#) [MD1-21PS](#) [MDM-15SCBRM7-F222](#) [MDM96517-699](#) [MDM96521-744](#) [MDVB1-21SL1](#) [MIK0-1-7SH003](#) [MIKQ6-7SH076](#) [MIKQ7-7PH077](#) [MIKQ7-7PH11](#) [MIKQ7-7PH32](#) [MIKQ9-7PH003](#) [MJSV-28SL61](#) [MKJ4A1F14-55S](#) [8-135760-3](#)