

ohne / without

Mutter / nut

max. Einschraubtiefe 5.0 mm
thread depth max. 5.0 mm

Bolzen / bolt

max. Einschraubtiefe 5.5 mm
thread depth max. 5.5 mm

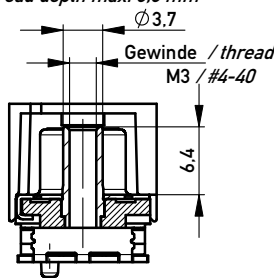
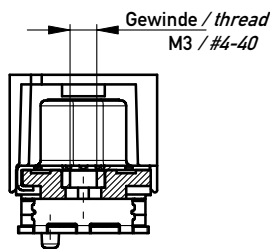
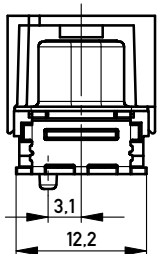

M 1:1

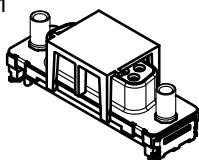

Anschlussbereich verzinkt
terminal area tin plating

Koplanarität der Anschlüsse ≤ 0.1 mm
coplanarity area of termination ≤ 0.1 mm

Anforderungsstufe: 2
class: 2

Beschriftung nach Bedruckungsvorschrift 174538
Part marking according to specification 174538

194275	174390	X			
194276	164030			#4-40	
194277	164026			M3	
194278	164022		#4-40		
194279	164018		M3		
Ident-Nr. part-no. tape & reel	Ident-Nr. part-no. tray	ohne without	Mutter thread	Bolzen bolt	Bemerkung remark

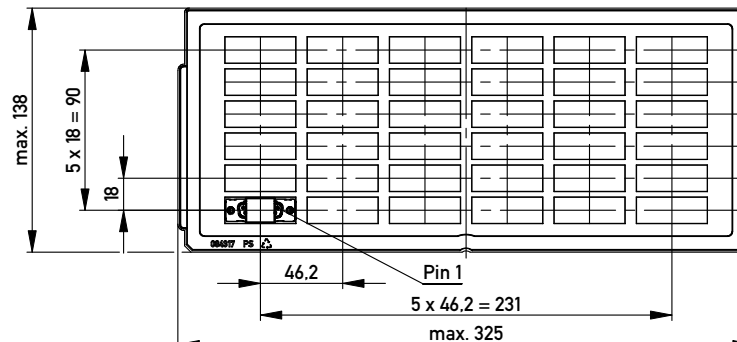

Verpackt in Tray
Verpackungseinheit 36 St.
tray packaging
packaging unit 36 pcs

Sonstige Angaben siehe Zeichnung 204628 / Additional indications according to drawing 204628

Verpackt in Gurtverpackung - Tape on Reel Packaging
Verpackungseinheit: 120 Stück - Packaging unit: 120 pcs

Abspulrichtung - Reel off Direction

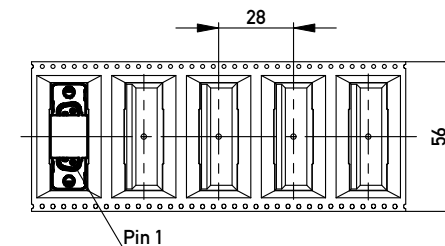
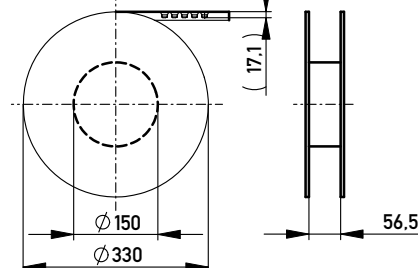

Sonstige Angaben siehe Zeichnung 204654 / Additional indications according to drawing 204654

Layoutvorschlag:
recommended layout:

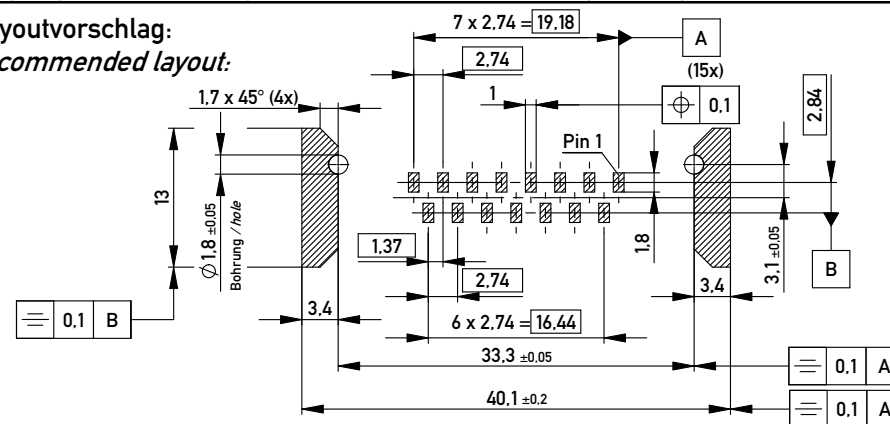

Fehlende Masse und Angaben siehe DIN 41652 / Missing information and dimensions according to DIN 41652

Sonstige Angaben siehe Fertigungsunterlagen / Additional indications please see the production documentation

Information: All rights reserved. Only for Information. To ensure that this is the latest version of this drawing, please contact one of the ERNI companies before using.	Tolerances	 All Dimensions in mm	Scale	2:1
	Subject to modification without prior notice. Drawing will not be updated.		Designation	
www.ERNI.com	TMC-S 15-SMD-6.3-BA8 TMC-S 15-SMD-6.3-type 8		144894	
	e Index	19.04.2010 Date	Class TMCS	I A3

X-ON Electronics

Largest Supplier of Electrical and Electronic Components

Click to view similar products for [D-Sub Standard Connectors](#) category:

Click to view products by [ERNI](#) manufacturer:

Other Similar products are found below :

[56F711-015](#) [012-9507-004](#) [LV242999-142T12](#) [015-0341-000](#) [015-0349-000](#) [015-0372-005](#) [015-0372-008](#) [015-8755-001](#) [020419-0104](#) [012-0467-000](#) [012-0515-000](#) [012-9507-034](#) [012-9507-114](#) [020745-0008](#) [609-25P](#) [M24308/2-23Z](#) [M24308315F](#) [CT2-14S-2PCA34](#) [CT2-18-11PCAU](#) [CT2-36-15SC](#) [CT6-14S-2SC](#) [CT6E14SA7SC](#) [CT6E22-14PC](#) [CT6E22-14PS](#) [CT6E22-22PS](#) [M83513/01-FC](#) [M85049/48-3-2F](#) [6STD09PCM99B70X](#) [6STD09SCM99B30X](#) [6STD09SCT99S40X](#) [6STD15PCT99S40X](#) [6STD15SCM99B30X](#) [6STD15SCT99S40X](#) [6STF09PCM05B70X](#) [7-135760-9](#) [MC11E-10-6SN](#) [747552-3](#) [MD1-21PS](#) [MDM-15SCBRM7-F222](#) [MDM96517-699](#) [MDM96521-744](#) [MDVB1-21SL1](#) [MIK0-1-7SH003](#) [MIKQ6-7SH076](#) [MIKQ7-7PH077](#) [MIKQ7-7PH11](#) [MIKQ7-7PH32](#) [MIKQ9-7PH003](#) [MJSV-28SL61](#) [MKJ4A1F14-55S](#)