

ohne / without

Mutter / nut
thread depth max. 7.5 mm
max. Einschraubtiefe 7.5 mm

Bolzen / bolt
max. Einschraubtiefe 5.5 mm
thread depth max. 5.5 mm
Ø 3.7

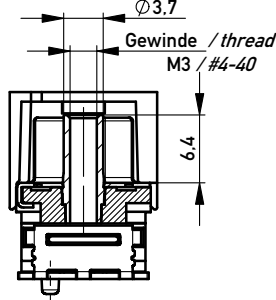
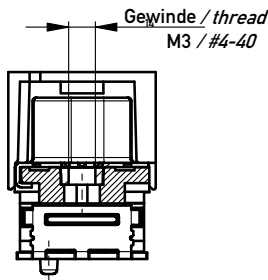
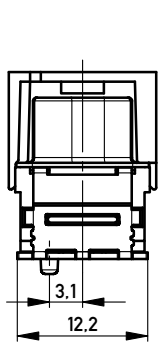

M 1:1

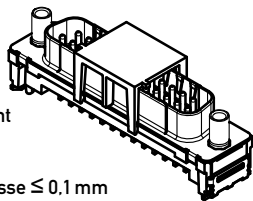

Anschlussbereich verzinkt
terminal area tin plating

Koplanarität der Anschlüsse ≤ 0.1 mm
coplanarity area of termination ≤ 0.1 mm

Anforderungsstufe: 2
class: 2

194315	194310	X			
194316	194311			#4-40	
194317	194312			M3	
194318	194313		#4-40		
194319	194314		M3		
Ident-Nr. part-no. tape & reel	Ident-Nr. part-no. tray	ohne without	Mutter thread	Bolzen bolt	Bemerkung remark

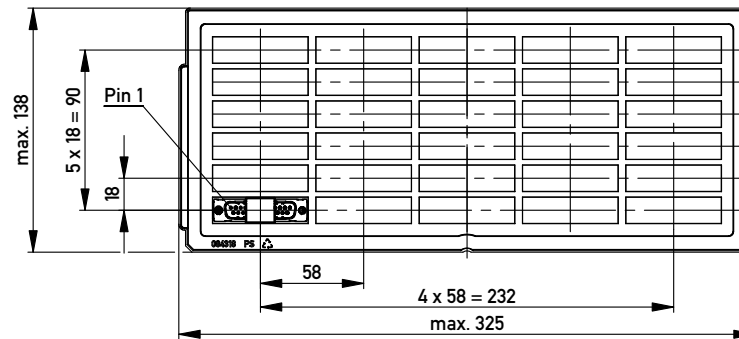

Verpackt in Tray
Verpackungseinheit 30 St.
tray packaging
packaging unit 30 pcs

Sonstige Angaben siehe Zeichnung 204628 / Additional indications according to drawing 204628

Verpackt in Gurtverpackung - Tape on Reel Packaging
Verpackungseinheit: 75 Stück - Packaging unit: 75 pcs

Abspulrichtung - Reel off Direction

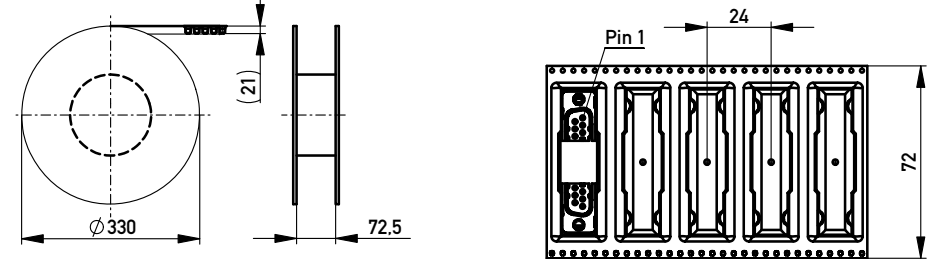

Sonstige Angaben siehe Zeichnung 204654 / Additional indications according to drawing 204654

Layoutvorschlag:
recommended layout:

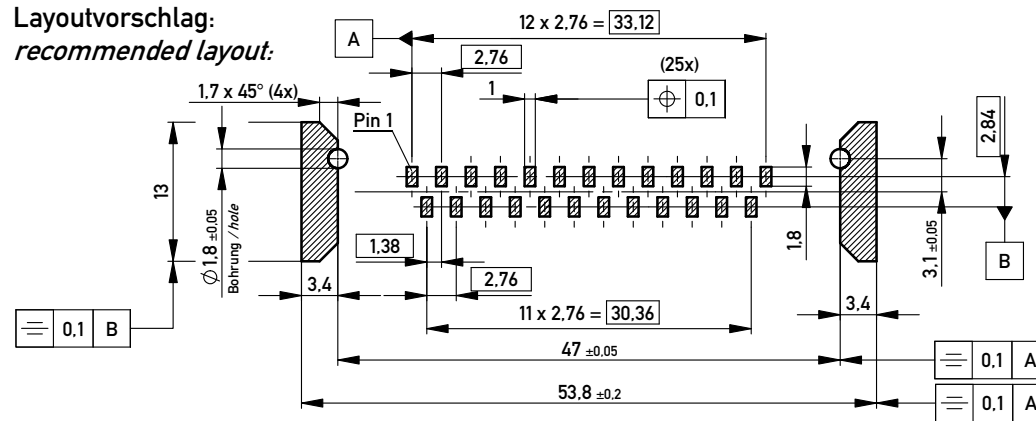

Fehlende Masse und Angaben siehe DIN 41652 / Missing information and dimensions according to DIN 41652
Sonstige Angaben siehe Fertigungsunterlagen / Additional indications according to the production documentation

Information:

Tolerances

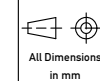

Scale 2:1

All rights reserved.
Only for Information.
To ensure that this is the latest
version of this drawing, please
contact one of the ERNI companies
before using.

Subject to modification without
prior notice.
Drawing will not be updated.

Designation

TMC-P 25-SMD-9,0-BA8
TMC-P 25-SMD-9,0-type 8

ERNI www.ERNI.com

144909

1
A3

Copyright by ERNI GmbH.
Proprietary notice pursuant to ISO 16106 to be observed.

e 26.09.2011
Index Date

Class TMCP

X-ON Electronics

Largest Supplier of Electrical and Electronic Components

Click to view similar products for [D-Sub Standard Connectors](#) category:

Click to view products by [ERNI](#) manufacturer:

Other Similar products are found below :

[56F711-015](#) [012-9507-004](#) [LV242999-142T12](#) [015-0341-000](#) [015-0349-000](#) [015-0372-005](#) [015-0372-008](#) [015-8755-001](#) [020419-0104](#) [012-0467-000](#) [012-0515-000](#) [012-9507-034](#) [012-9507-114](#) [020745-0008](#) [609-25P](#) [CT2-14S-2PCA34](#) [CT2-18-11PCAU](#) [CT2-36-15SC](#) [CT6-14S-2SC](#) [CT6E14SA7SC](#) [CT6E22-14PC](#) [CT6E22-14PS](#) [CT6E22-22PS](#) [M83513/01-FC](#) [M85049/48-3-2F](#) [6STD09PCM99B70X](#) [6STD09SCM99B30X](#) [6STD09SCT99S40X](#) [6STD15PCT99S40X](#) [6STD15SCM99B30X](#) [6STD15SCT99S40X](#) [6STF09PCM05B70X](#) [7-135760-9](#) [MC11E-10-6SN](#) [747552-3](#) [MD1-21PS](#) [MDM-15SCBRM7-F222](#) [MDM96517-699](#) [MDM96521-744](#) [MDVB1-21SL1](#) [MIK0-1-7SH003](#) [MIKQ6-7SH076](#) [MIKQ7-7PH077](#) [MIKQ7-7PH11](#) [MIKQ7-7PH32](#) [MIKQ9-7PH003](#) [MJSV-28SL61](#) [MKJ4A1F14-55S](#) [8-135760-3](#) [8STD09PCM99B30X](#)