

ohne Verriegelung
without interlocking

mit Verriegelung
with interlocking

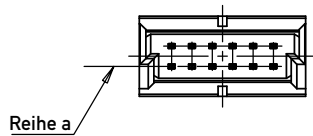

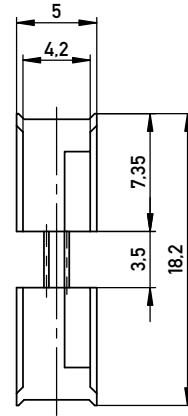
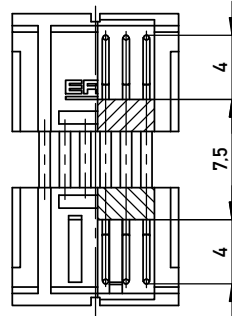
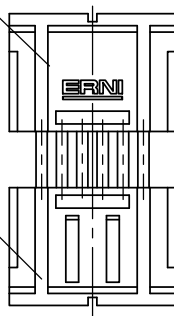
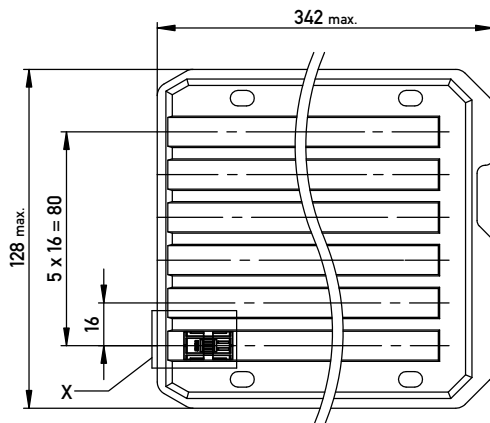

Verpackt in Tray -tray packaging
Verpackungseinheit 102 Stück -packaging unit 102

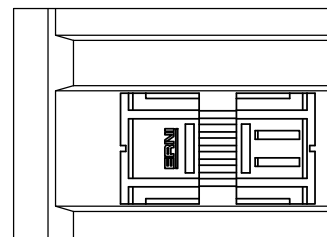

Einzelheit X (M 2:1)
detail X



Adapterstück für board-to-board Abstand von 20mm (beidseitig verbaut mit Federleiste: 154805, Low Profile)
Adapter for board-to-board height 20mm (in combination with two female connectors: 154805, low profile)

Information: All rights reserved. Only for Information. To ensure that this is the latest version of this drawing, please contact one of the ERNI companies before using.	Tolerances  All Dimensions in mm	Scale 3:1		
	Subject to modification without prior notice. Drawing will not be updated.	Designation 1,27 DRC Adapterstück BTB 20mm 12-polig		
a Index	06.10.2015 Date	 www.ERNI.com		1 A3
		Class DRCBTB		

Copyright by ERNI GmbH
Proprietary notice pursuant to ISO 16016 to be observed.

X-ON Electronics

Largest Supplier of Electrical and Electronic Components

Click to view similar products for [Board to Board & Mezzanine Connectors](#) category:

Click to view products by [ERNI](#) manufacturer:

Other Similar products are found below :

[589158040000018](#) [FCN-230C068-11](#) [FCN-268F012-G/BD](#) [FCN-268F036-G/BD](#) [FCN-268M012-G/0D](#) [FCN-268M024-G/1D](#) [FCN-723J004/1](#) [MIS-048-01-F-D-DP-K](#) [832-10-034-10-001000](#) [FX4C-80S-1.27DSA](#) [FCN-214Q030-G/0](#) [FCN-234P048-G/0](#) [FCN-235D050-G/C](#) [210-93-314-41-105000](#) [2-22603-0](#) [MDF7-40DP-2.54DSA\(55\)](#) [AXG720047](#) [5031084030](#) [MIT-114-03-F-D-K](#) [55323-1519](#) [DF33-2P-3.3DSA\(24\)](#) [YFT-20-05-H-03-SB-K](#) [503308-3040](#) [026-6203-PDB](#) [027-6203-PDB](#) [069159702701000](#) [10123981-102LF](#) [101A10019X](#) [55650-0588-C](#) [68684-306](#) [75140-7012](#) [589159005003045](#) [194261-1](#) [FCN-268F024-G0D](#) [10124054-515LF](#) [68685-603](#) [8-1616154-3](#) [MIS-019-01-F-D](#) [589159005002045](#) [541371078](#) [IL-WX-10PB-HF-B-E1000E](#) [FCN-268M024-G/3D](#) [20021832-06016C1LF](#) [KX15-20KLDL-E1000E](#) [MDF7-16DP-2.54DSA\(55\)](#) [AXE810124](#) [FCN-214J100-G/0](#) [FCN-230C068-E/S](#) [AXE812124](#) [AXE816124](#)