

A
B
C
D
E
F

A
B
C
D
E

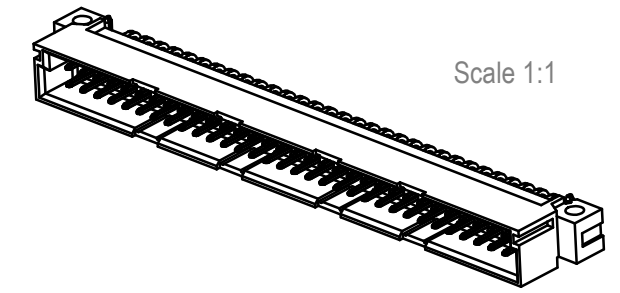

Bestückungsplan / contact layout

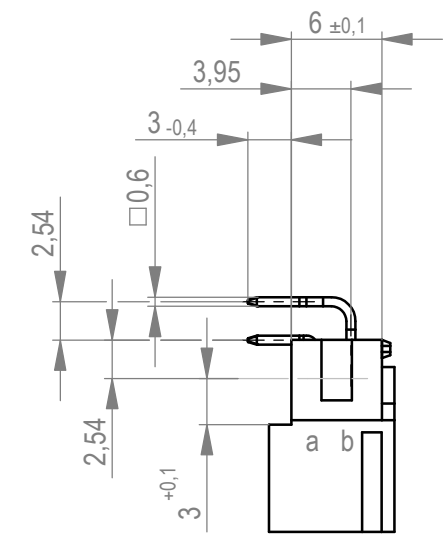
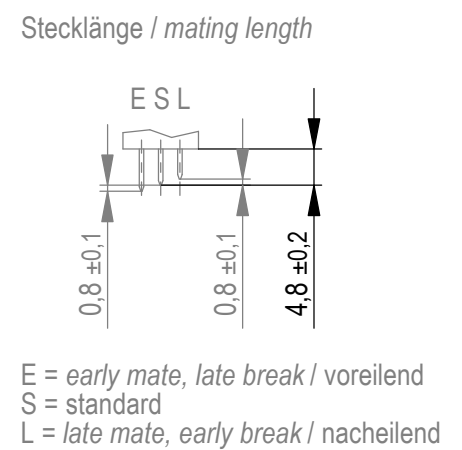
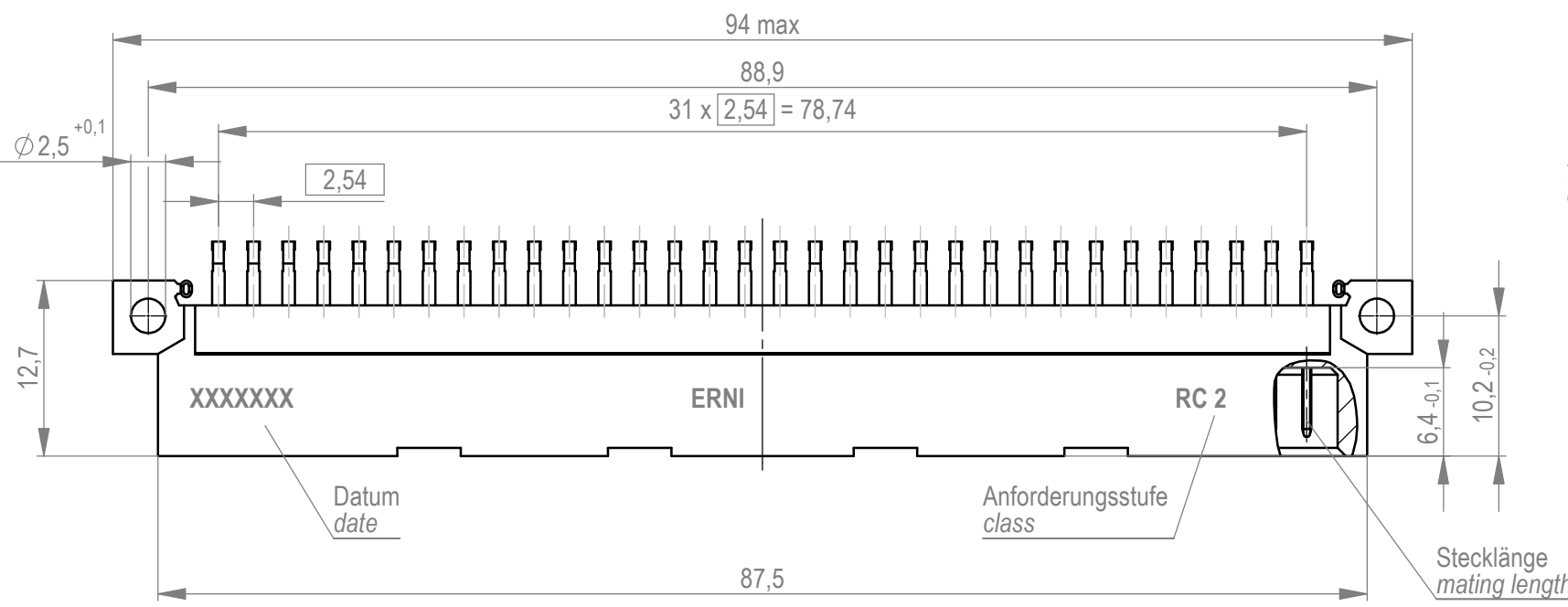
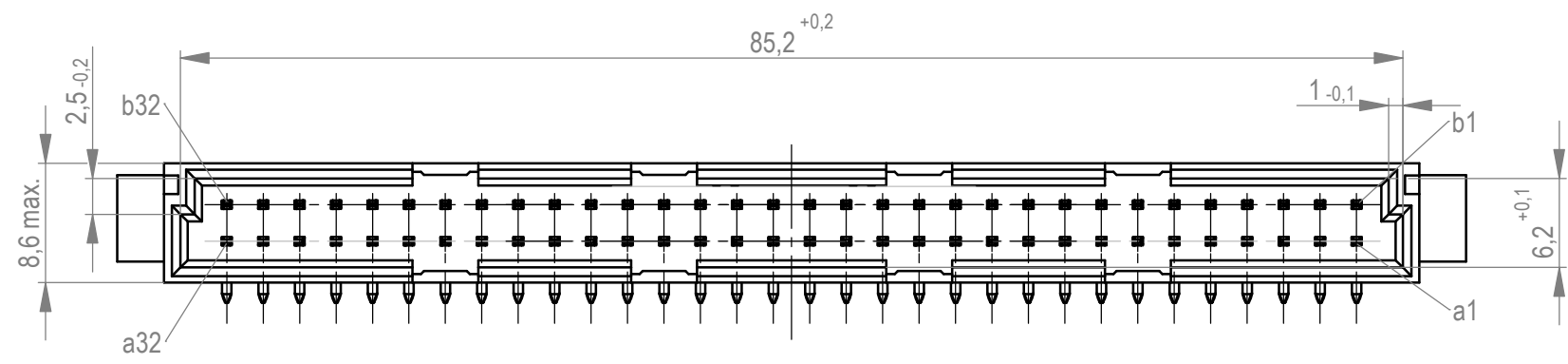
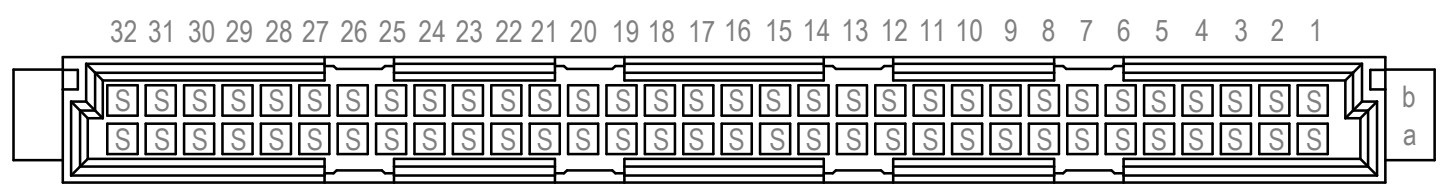

Lötanschluss 0,6x0,6mm
solder terminal 0,6x0,6mm

Anforderungsstufe 2 = 400 Steckzyklen
performance class 2 = 400 mating cycles

Fehlende Maße und Angaben nach IEC 60 603-2 / DIN EN 60 603-2
Missing information and dimensions per IEC 60 603-2 / DIN EN 60 603-2

Leiterplatten- Lochbild / PCB drillhole pattern

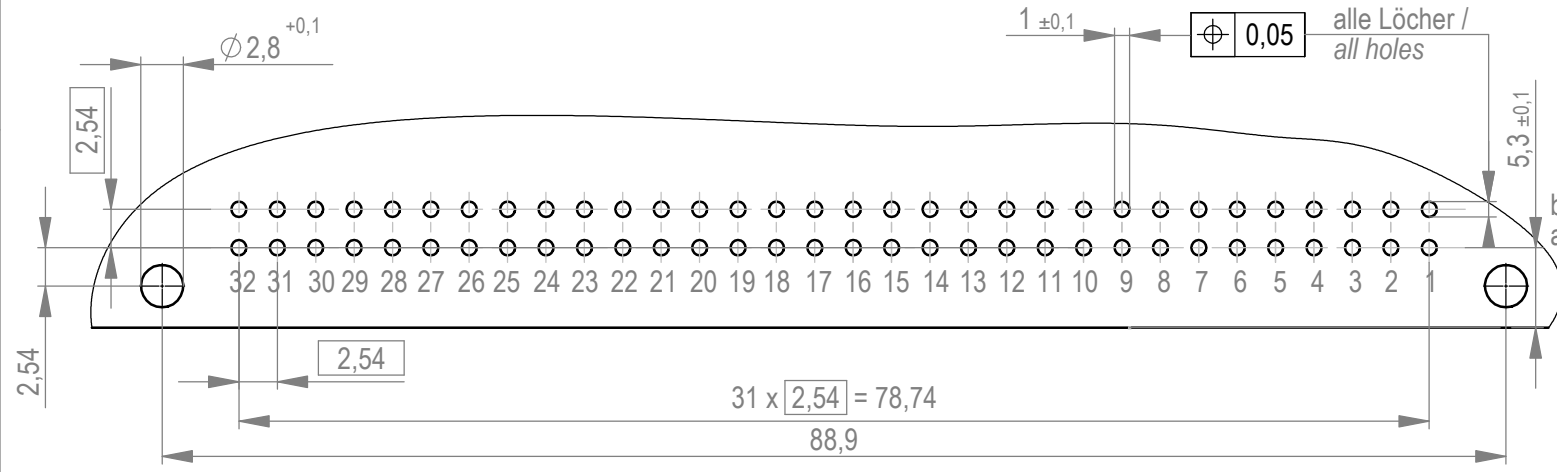

Dimension no.	Tolerances Dim. for Information ISO 8015	All Dimensions in mm	Scale 2:1	Material
Customer drawing: All rights reserved. Only for Information. To ensure that this is the latest version of this drawing, please contact one of the ERNI companies before using.	Subject to modification without prior notice. Drawing will not be updated.		DIN 41612 / IEC-60603-2 Male Connector B 64 Solder Type 4 384241	
a Index	28.05.2021 Date		ERNI International AG Zürichstrasse 72 8306 Brüttisellen - Zürich Switzerland	I A3
			Class	STVB

Weitergabe sowie Vervielfältigung dieses Dokuments, Verwertung und Mitteilung seines Inhalts sind verboten, soweit nicht ausdrücklich gestattet. Zuwiderhandlungen verpflichten zu Schadenersatz. Alle Rechte für den Fall der Patent-, Gebrauchsmuster- oder Geschmacksmustererhaltung vorbehalten. The reproduction, distribution and utilization of this document as well as the communication of its contents to others without express authorization is prohibited. Offenders will be held liable for the payment of damages. All rights reserved in the event of the grant of a patent, utility model or design.

Die deutsche Version dieser Zeichnung dient nur zur Erleichterung der Handhabung. Bei Abweichungen von dem englischen Original gilt das englische Original. The german version of this drawing has been offered for convenience only and may deviate from the english original. In case of any deviation the English version shall prevail.

X-ON Electronics

Largest Supplier of Electrical and Electronic Components

Click to view similar products for [DIN 41612 Connectors](#) category:

Click to view products by [ERNI](#) manufacturer:

Other Similar products are found below :

[004.767](#) [608489050008049](#) [691327-1](#) [74670-0732](#) [74680-0340](#) [75880-0015](#) [76453-0014](#) [86093159ALF](#) [9732967801](#) [QLC260R](#)
[120X10019X](#) [120X10089X](#) [122A10249X](#) [122A11089X](#) [122A13089X](#) [122A10089X](#) [122A10129X](#) [122A10349X](#) [122A13359X](#) [1377391-4](#)
[DIN-048CPC-SR1-MH](#) [1393583-2](#) [1393726-7](#) [140X10129X](#) [143-1913-000](#) [143-1908-000](#) [1484472-1](#) [2110070-1](#) [2110070-2](#) [CBC20T00-](#)
[008FDS5-0-1-002VR](#) [172699-5036](#) [2-1393557-4](#) [2-1437084-2](#) [394506](#) [419-2080-402](#) [419-2085-302](#) [V42254B2202C968](#) [419-2086-201](#) [419-](#)
[2087-002](#) [448657-1](#) [448847-3](#) [5-1393755-9](#) [02990000004](#) [033020](#) [043619](#) [054302](#) [043556](#) [0760557108](#) [09062483201750](#) [0850033067](#)