

# PRO2005W2E

- premium quality plug type 5 V power supply

## FEATURES:

- compact design
- high power output
- premium class design
- safe and reliable power source
- high efficiency ErP Ecodesign and Energy Star Level VI compliance
- no load power consumption 90 mW

## APPLICATIONS:

- consumer electronics
- IT/office equipment
- general purpose
- computer devices
- home and building automation
- security and monitoring systems
- POS, POI equipment
- telecommunications equipment



**PRO2005W2E** is a compact and efficient 20-watt wall-mounted style plug type power unit for various types of electronic devices. It is based on high quality electronic components that allow continuous, long-lasting work in all conditions. It is reliable, fully protected and stable. It provides high efficiency and excellent specification.

## TECHNICAL SPECIFICATION

Group	Parameter	Value	Conditions
Input	Rated input voltage	100-240 VAC	
	Input voltage range	90-264 VAC	
	Mains frequency range	47-63 Hz	
	AC current (max.)	0.8 A	At 100 VAC and full load
	Inrush current (max.)	70 A	
	No load power consumption	90 mW	
	Input leakage current (max.)	0.25 mA	At 264 VAC
	Power factor	0.5	
Output	Rated output voltage	5 V	
	Rated output power	20 W	
	Rated output current	4 A	
	Average efficiency	84%	At 230 VAC
	Light load efficiency	82%	At 10% rated load
	Efficiency compliance	Energy Star Level VI, ErP	
	Line regulation	±2%	
	Load regulation	±6%	
	Ripple and noise	150 mVp-p	At 100 VAC
	Minimal output current	No	
	Hold up time (max.)	3 ms	At 100 VAC and full load
	DC voltage rise time (max.)	100 ms	At 100 VAC and full load
Turn on delay time (max.)	800 ms		
Environmental	Working temperature	-20 to +40°C	
	Working humidity	5% to 95% RH	40°C
	Storage temperature	-40°C to +85°C	
	Cooling method	Free air circulation	
Protection	Short circuit	Yes	
	Overcurrent	Yes, 120-135%	
	Output overvoltage	Yes	
	Automatic recovery on fault remove	Yes	
Safety and EMC	Withstand isolation voltage	3 kVAC (input to output)	5 mA, 1 min
	Isolation resistance	100 MΩ	500 VDC
	Isolation class	2	
	Safety compliance	EN62368	
	EMC compliance	EN55032 class B EN61000-4	
	Marking	RoHS, CE	
Mechanical and features	Enclosure	Black ABS plastic	
	Size	67 × 41 × 30 mm	L × W × H
	Weight	122 g	
	Output connector	DC Jack 2.1×5.5×11 mm plug	
	Input connector	EU 2-pole plug	
	Output cable	1.2 m	0.82 mm <sup>2</sup>
	Single package	85 × 85 × 30 mm	
	Packing	450 × 410 × 280 mm	
	Warranty	2 years	

## Notes:

Unless otherwise stated, all parameters are specified at 230 VAC input voltage, 50 Hz, ambient temperature 25°C and relative humidity 70% for rated load output. The values of parameters related to the output voltage regulation is measured from low to high line or for load changes from 0 to 100%, respectively. The power supply is considered as an independent unit, but the final equipment still need to reconfirm that the whole system complies with the EMC directives. If the PSU is installed in the final device as a subassembly, the tests should be repeated to verify that the system has been met compliance. Detailed technical data are available on request.

## BLOCK DIAGRAM

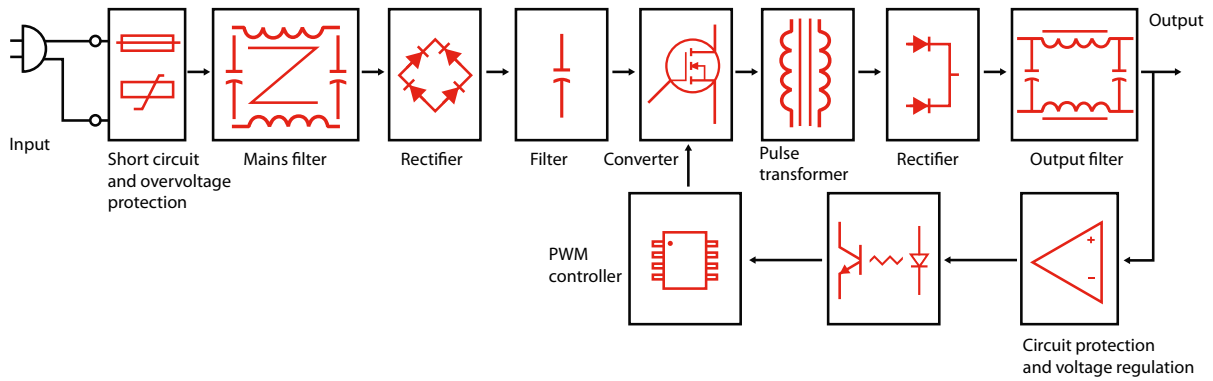

## MECHANICAL SPECIFICATION

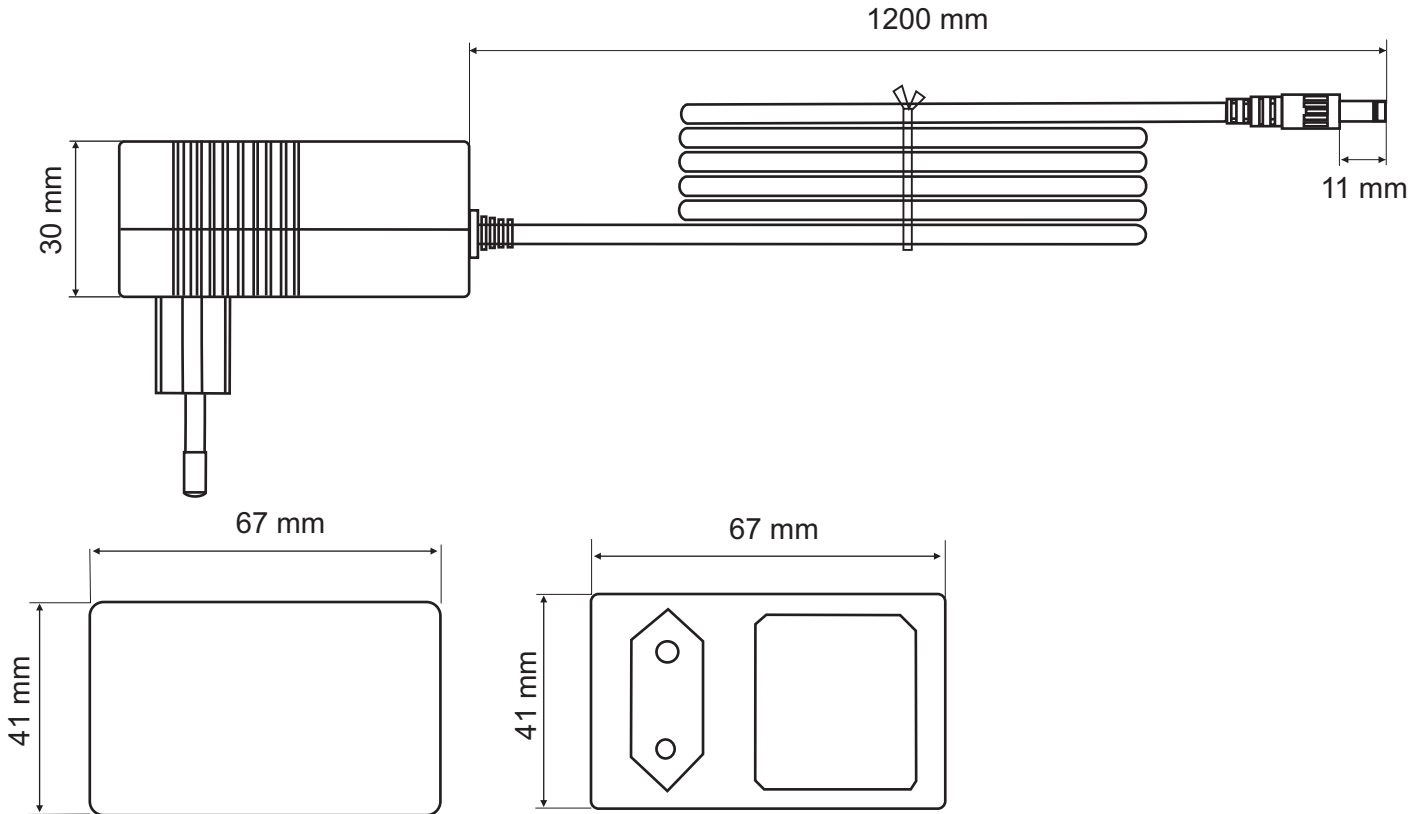

## PRODUCT LABEL

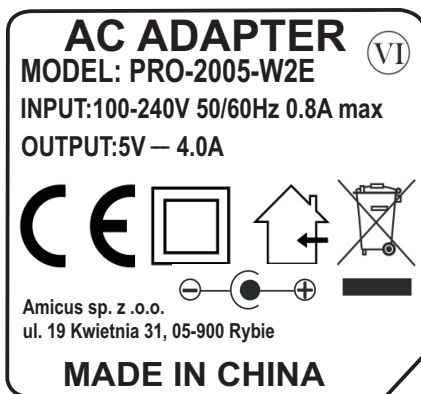

### Legend to the label icons:

- - II safety class: no grounding is required, no dangerous voltage even in an emergency situation will appear on output
- 🏠 - power supply intended for indoor use only
- (VI) - high efficiency and low no load power consumption, meeting the requirements of Energy Star Compliance Level 6 and ErP
- ♻️ - the product must not be disposed of in normal waste containers

## MARKING SYSTEM

### PRO2005W2E

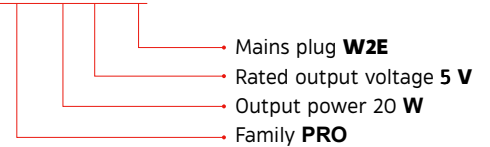

## X-ON Electronics

Largest Supplier of Electrical and Electronic Components

*Click to view similar products for [Espe manufacturer](#):*

Other Similar products are found below :

[E2409W2E](#) [E2409W2E-2555S](#) [E2412W2E-1335](#) [E2412W2E-2155](#) [E2412W2E-2555](#) [E2412W2E-2555-L](#) [E2415W2E](#) [E2415W2E-1748](#)  
[E2415W2E-2555](#) [E2424W2E-2155](#) [E2424W2E-2155L](#) [E2424W2E-2555](#) [E2424W2E-2555L](#) [E3612C8](#) [E3612C8-2155L](#) [E3612C8-2555L](#)  
[E3612C8-2555S](#) [E3612C8-2563](#) [E6012C8-2555L+OP](#) [E6012C8-2555+OP](#) [E6012C8+OP](#) [ESPE-0112-W2E-2155](#) [ESPE-0312-W2E-2155+OP](#)  
[ESPE-0312-W2E-BW](#) [ESPE-0312-W2E-JACK3.5L](#) [ESPE-0605-W2E-13345L](#) [ESPE-0605-W2E-2155](#) [ESPE-0605-W2E-2155+OP](#) [ESPE-](#)  
[0605-W2E-2555+OP](#) [ESPE-0605-W2E-IUSB](#) [ESPE-0606W2E-1740](#) [ESPE-0606-W2E-2155](#) [ESPE-0606-W2E-2155L](#) [ESPE-0606-W2E-](#)  
[2155L+OP](#) [ESPE-0606-W2E-2155+OP](#) [ESPE-0606-W2E-2555](#) [ESPE-0606-W2E-2555+OP](#) [ESPE-06UN-W2E](#) [ESPE-0909-W2E-1740](#)  
[ESPE-0909-W2E-1748L](#) [ESPE-0909-W2E-2155-CN+OP](#) [ESPE-0909-W2E-2155L-CN+OP](#) [ESPE-0909-W2E-2155+OP](#) [ESPE-0909-W2E-](#)  
[2555L+OP](#) [ESPE-0909-W2E-2555+OP](#) [ESPE-1005-W2E-IUSB+OP](#) [ESPE-1005-W2E-MICROUSB](#) [ESPE-1212-W2E-1335S](#) [ESPE-1212-](#)  
[W2E-2155](#) [ESPE-1212-W2E-2155L](#)