





Official Platform

-  www.espressif.com
-  blog.espressif.com
-  github.com/espressif
-  esp32.com | esp8266.com | bbs.espressif.com

Social Media

-  twitter.com/EspressifSystem
-  facebook.com/espressif
-  linkedin.com/company/espressif-systems
-  youtube.com/EspressifSystems
-  instagram.com/espressif_systems_official

Espressif Systems

 #304, Block 2, 690 Bibo Road, Pudong New Area, Shanghai, China 201203

ESPRESSIF

INNOVATING THE TECHNOLOGIES OF TOMORROW

Contents



About

About Espressif	01
ESP RainMaker	03
Global Ecosystem	05



ESP Products

Software

ESP-IDF	07
Hosted-Mode SDKs	07
Audio Development Framework	08
IoT Cloud Connectors	08
AI and Machine Learning SDK	08

Hardware

ESP Series of SoCs	09
ESP32-S3	10
ESP32-S2	11
ESP32-C3	12
ESP32	13
ESP8266	14



ESP Solutions

Audio Solutions	15
Face Recognition	18
ESP-HMI	19
ESP-MESH	20
Device Connectivity	21
ESP Insights	23



Support

Espressif's Customer Support	24
------------------------------------	----



About Espressif

A World-leading AIoT Platform

Espressif Systems (688018.SH) is a public, multinational, fabless, semiconductor company established in 2008. We have a passionate team of engineers and scientists from all over the world, focused on developing cutting-edge, yet cost-effective, MCUs that achieve low-power, wireless communication. Espressif is proud of its high-performance hardware, as well as its development frameworks which are designed in-house from the ground up. Espressif provides millions of users with a variety of secure AIoT solutions relating to facial recognition, voice interaction, mesh networking, human interaction and Cloud connectivity, across the whole wide world.

1st

With the biggest share of the global Wi-Fi MCU market (for four years in a row).



Our products are distributed all over the world.



We provide millions of users with a variety of AIoT solutions.



Espressif's Worldwide Expansion



Vision and Mission

Espressif is committed to providing open-source AIoT solutions to its customers and developers, commercial and non-commercial alike, so that developers from all walks of life can use this technology to solve some of the most pressing problems of our times.



A Complete-Solution Provider

ESP-MDF for mesh connectivity, ESP-ADF for voice recognition, and ESP-WHO for face detection and recognition.

ESP-IDF integrates a real-time operating system with drivers for peripherals, network protocol stacks for Wi-Fi and Bluetooth, as well as various utility libraries and development tools.

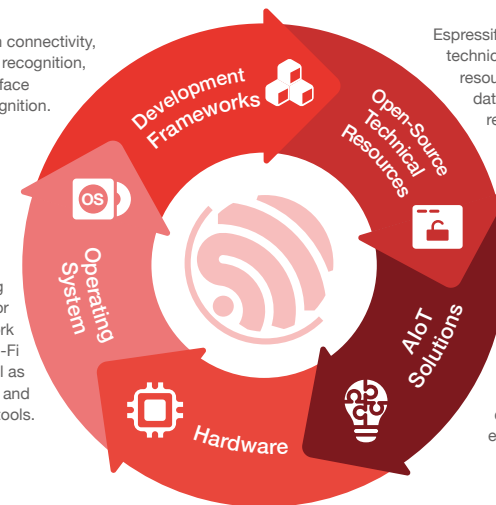

Espressif offers a variety of technical documents and resources for free, including datasheets, technical reference manuals, user guides, API references, test reports, etc.

Espressif provides audio, face recognition, HMI, device-connectivity solutions, which are widely used in the areas of smart home, industrial control, consumer electronics, etc.

High-performance Wi-Fi + Bluetooth / Bluetooth LE + IEEE 802.15.4 + AI SoCs, Modules and DevKits, including the ESP8266, ESP32, ESP32-S, ESP32-C and ESP32-H Series.

A Complete AIoT Solution

ESP RainMaker®

ESP RainMaker® provides a complete solution for building AIoT products with a minimal amount of code. It covers all Espressif chips and modules, device firmware, phone apps, voice-assistant integrations and Cloud backend. It enables customers to quickly build their own AIoT solutions based on enterprise-grade Cloud computing, with a single-click deployment.

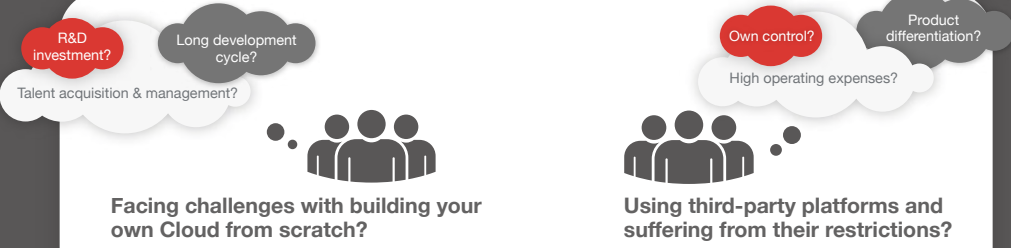
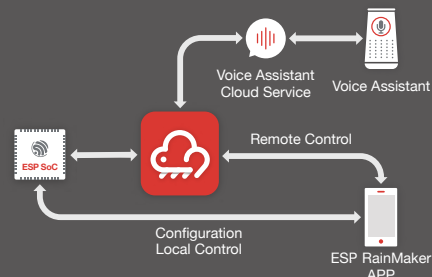

Accelerate Your AIoT Business with Your Own Platform

- ✓ Minimize your R&D investment and business risks by using Espressif's turnkey solution.
- ✓ Focus on product innovation and differentiation with full customization.
- ✓ Ensure your business upscaling runs in a secure and stable environment.
- ✓ Gain independence by deploying your own Cloud.
- ✓ Progress quickly by shortening the development cycle.

 Turnkey Solution Significantly simplifies connected-device development and maintenance.	 Pay-as-You-Grow Pay only when your business starts to grow.	 Independence Own devices and user data in private Cloud.	 Innovation Focus on fulfilling and developing your marketing needs.
--	--	---	--

ESP RainMaker Offer

Device SDK & Firmware

Production-ready, open-source firmware for different product categories is available to all customers, who can then build their own products, using the ESP RainMaker device SDK.

Voice-assistant Integrations

Ready-made support for Alexa & Google Assistant integration through smart-home skills and actions. Customers can also create their own custom skills.



ESP SoCs & Modules

We provide customers with the most cost-effective, yet powerful, SoCs and modules that suit different product needs. ESP RainMaker works with all of Espressif's modules and SoCs.

Device Management with Own Private Cloud

Fleet Management, OTA Upgrades, Device Diagnostics, Business Insights

Open-Source Phone Apps

The app provides functions including User Management, Device Association, Scheduling, Device Sharing, Network Configuration, Local and Remote Control, Grouping, etc. Customers can also build their own apps.

Third-party Service Support

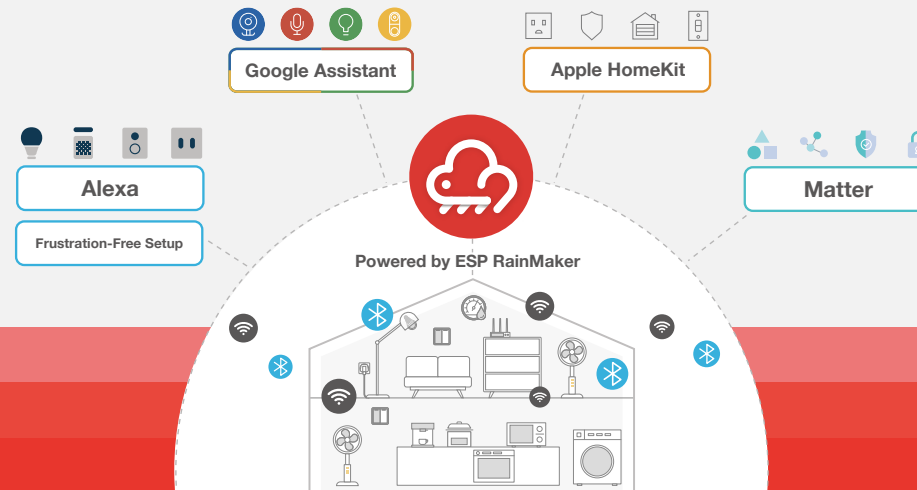

ESP RainMaker: rainmaker.espressif.com
 Get Started: rainmaker.espressif.com/docs/get-started.html

Global Ecosystem

Development Platforms

ESP-IDF is Espressif's open-source and field-proven platform that already powers millions of connected devices. Espressif also contributes to open-source, real-time operating systems, such as NuttX and Zephyr, thus giving developers more choice when creating their own applications.

Espressif's products are also compatible with Arduino IDE, Amazon FreeRTOS, NodeMCU, MicroPython, PlatformIO, and Mongoose OS.

Third-Party Cloud Platforms

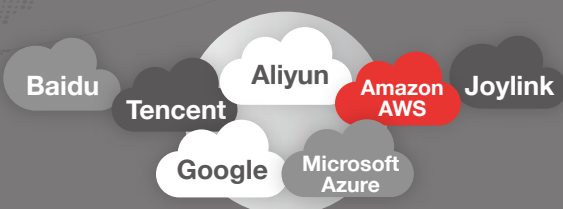

40+ mainstream Cloud platforms support Espressif products

Active Community Engagement



60 K+ open-source, Espressif-powered projects on GitHub



100+ books written about Espressif's SoCs in 10+ languages



Internationally ranked 5th on GitHub for projects built with the C language



31 M+ search results for ESP8266 and ESP32 on Google



1.5 M+ views for the most popular videos of Espressif-powered projects on YouTube

Hardware and Software

Innovating for Quality

Espressif is the first company to have successfully integrated an antenna switch, RF balun, power amplifier, low-noise receive amplifier, filters, and power-management modules for Wi-Fi applications in CMOS technology. As such, the entire solution occupies a minimal Printed Circuit Board (PCB) area.



Small and simple design

Improved yield and high reliability

Low cost

Minimal manufacturing and logistical complexity

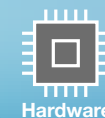

Hardware



Software

Unlocking the Potential of the AIoT Development

Espressif has already left an indelible mark on the IoT industry and maker communities worldwide, having built a modern software platform which is based on the community-driven development of its powerful wireless MCUs. Espressif's SDKs provide toolchains, APIs, components and workflows for fast, secure and cost-effective application development, while Espressif's SoCs are compatible with all the main operating systems, such as Windows, Linux and Mac OS. This way, developers can easily use the Espressif SDK of their preference to build new AIoT applications, or migrate their existing applications to the ESP hardware platform of their choice. As a result, Espressif SoCs have already powered millions of devices in the field, and are recognized as the driving force of innovation in the AIoT industry.

Espressif's Software Platform

ESP-IDF

ESP-IDF is Espressif's official IoT Development Framework for the ESP32, ESP32-S, ESP32-C and ESP32-H series of SoCs. It provides a self-sufficient SDK for any generic application development on these platforms, using programming languages such as C and C++. ESP-IDF currently powers millions of devices in the field, and enables building a variety of network-connected products, ranging from simple light bulbs and toys to big appliances and industrial devices.



ESP-IDF

Network Provisioning	OTA Upgrade Library	Manufacturing Utilities	Common Networking Protocols	Examples	
File Systems	Object Storage	POSIX and C++ Support	Network Security	Crypto Library	IDE Plugins
Peripherals Drivers	Power Management	Wi-Fi & Bluetooth LE Mesh Networking	TCP/IP Stack	Bluetooth/Bluetooth LE Stack	Build System
RTOS Kernel	SoC Support	Software Bootloader	Wi-Fi MAC Library	Bluetooth Controller	Developer Tools

ESP-IDF: github.com/espressif/esp-idf

Hosted-Mode SDKs

ESP-AT

SDK based on an AT command set for the network connectivity of host MCUs.

ESP-AT: github.com/espressif/esp-at

ESP-Hosted: github.com/espressif/esp-hosted

ESP-Hosted

Native network interface SDK for the network connectivity of host MCUs.

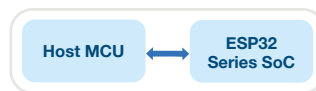

Audio Development Framework



ESP-ADF

This is an SDK for building audio applications with Espressif SoCs. This includes audio pipelining, a variety of codecs, containers, playlist parsers and higher-level audio protocols.

ESP-ADF: github.com/espressif/esp-adf

IoT Cloud Connectors

ESP RainMaker®: github.com/espressif/esp-rainmaker

AWS IoT: github.com/espressif/esp-aws-iot

Google Cloud IoT Core: github.com/espressif/esp-google-iot

Microsoft Azure IoT: github.com/espressif/esp-azure

Joylink IoT Cloud: github.com/espressif/esp-joylink

Aliyun IoT Cloud: github.com/espressif/esp-aliyun

Tencent IoT Cloud: github.com/espressif/esp-qcloud

Baidu IoT Core: github.com/espressif/esp-baidu-iot



AI and Machine Learning SDK

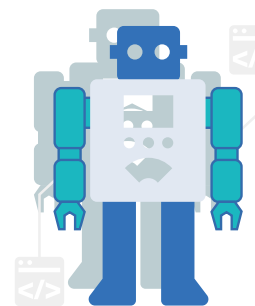

ESP-DL





This is an SDK that implements an optimized kernel, various models, model conversion tools and hardware acceleration implementation for Espressif SoCs.

ESP-DL: github.com/espressif/esp-dl



Espressif's Series of SoCs

Espressif drives the development of AIoT solutions, with its complete MCUs featuring integrated Wi-Fi and Bluetooth connectivity.

	Connectivity	Core	ROM	RAM	GPIO	AI Acceleration
	Wi-Fi + Bluetooth 5 (LE)	Xtensa® LX7 32-bit Dual Core	384 KB	512 KB	45	Yes
	Wi-Fi	Xtensa® LX7 32-bit Single Core	128 KB	320 KB	43	/
	Wi-Fi + Bluetooth 5 (LE)	RISC-V 32-bit Single Core	384 KB	400 KB	22	/
	Wi-Fi + Bluetooth 4.2 (BR/EDR + LE)	Xtensa® LX6 32-bit Single/Dual Core	448 KB	520 KB	34	/
	Wi-Fi	Xtensa® L106 32-bit Single Core	64 KB	160 KB	17	/



Learn More
espressif.com

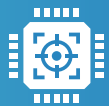

Product Selector
espressif.com/product-selector



Contact Us
espressif.com/sales

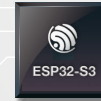

ESP32-S3



A Wi-Fi and Bluetooth 5 (LE) MCU Designed for AIoT Applications with Powerful AI Acceleration and Reliable Security Features

Features



CPU & Memory

- Xtensa® 32-bit LX7 dual-core processor with a five-stage pipeline that operates at up to 240 MHz
- 384 KB ROM, 512 KB SRAM, external Quad SPI/Octal SPI/QPI/OPI 1GM flash and 1GB RAM



Connectivity

- 2.4 GHz Wi-Fi 802.11 b/g/n with HT20 / HT40
- Bluetooth 5 (LE) with Long Range support
- Wi-Fi and Bluetooth LE mesh support



Peripherals

- 45 programmable GPIOs: UART, SPI, I²C, I²S, PWM, ADC, TWAI, 14 capacitive Touch GPIOs, USB OTG v1.1



Security

- RSA-3072-based secure boot
- AES-128/256-XTS-based flash encryption
- Digital signature peripheral and the HMAC peripheral
- “World Controller” peripheral that provides two fully-isolated execution environments

Applications

- Smart home
- Industrial automation
- Human machine interface (HMI)
- Touch sensing
- Speech recognition
- Image recognition
- Voice-controlled devices
- USB devices

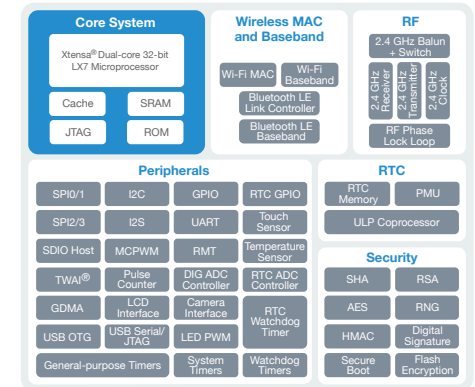

ESP32-S3 Block Diagram

Highlights

AI Acceleration

- Additional support for vector instructions in the MCU, which accelerates neural network computing and signal.

Outstanding Speech-Recognition Performance

- ESP32-S3 supports the single-chip offline speech recognition solution, WakeNet, which is a configurable Wake-Word Engine.
- MultiNet: Offline-command engine that can support up to 200 offline commands.
- Espressif's Audio Front-End Algorithms for Acoustic Echo Cancellation (AEC), Blind Source Detection (BSS), and Noise Suppression (NS) contribute to a great performance even in a noisy environment.

Learn More: espressif.com
Product Selector: espressif.com/product-selector
Contact Us: espressif.com/sales

ESP32-S2

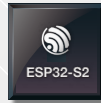

A Secure and Powerful Wi-Fi MCU with Numerous I/O Capabilities

Features



CPU & Memory

- Xtensa® 32-bit LX7 single-core processor that operates at up to 240 MHz
- 128 KB ROM, 320 KB SRAM, 16 KB SRAM in RTC, SPI/QSPI/OSPI supports multiple flash and external RAM chips



Connectivity

- 2.4 GHz Wi-Fi 802.11 b/g/n with HT20 / HT40



Peripherals

- 43 programmable GPIOs: UART, SPI, I²C, I²S, ADC, DAC, TWAI, LED PWM, LCD interface, camera interface, USB OTG, 14 capacitive Touch GPIOs



Security

- RSA-3072-based secure boot
- AES-128/192/256-XTS-based flash encryption
- Cryptographic accelerators for enhanced performance
- Protected private key and device encryption preventing outsiders from software access
- Protection against physical fault injection attacks

Applications

- Human machine interface (HMI)
- Cameras for video streaming
- Generic low-power IoT sensor hubs
- Generic low-power IoT data loggers
- Image recognition
- Speech recognition
- Smart home
- Industrial automation

Highlights

HMI Solution

- With an LCD interface and 14 configurable capacitive touch GPIOs, ESP32-S2 provides the optimal HMI solution to touchscreen and touchpad-based devices.

Unparalleled Security

- AES, SHA and RSA algorithms integrated into cryptographic accelerators.
- Additional hardware security features are provided by the RNG, HMAC and Digital Signature modules, along with flash encryption and secure boot signature verification features.

Low Power

- ESP32-S2's fine-grained clock gating, dynamic voltage and frequency scaling, together with its adjustable power amplifier output power contribute to an optimal trade-off between communication range, data rate and power consumption.

Learn More: [espressif.com](https://www.espressif.com)
 Product Selector: [espressif.com/product-selector](https://www.espressif.com/product-selector)
 Contact Us: [espressif.com/sales](https://www.espressif.com/sales)

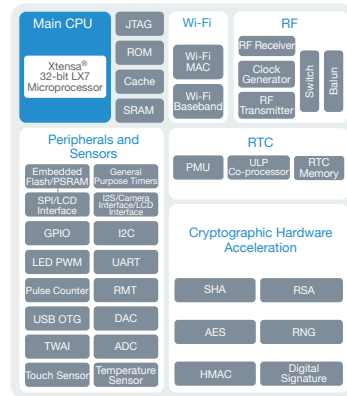

ESP32-S2 Block Diagram

ESP32-C3

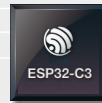

A Cost-Effective MCU with a RISC-V Single-Core CPU
 Wi-Fi and Bluetooth 5 (LE) Connectivity for Secure IoT Applications

Features



CPU & Memory

- 32-bit RISC-V single-core processor with a four-stage pipeline that operates at up to 160 MHz
- 384 KB ROM, 400 KB SRAM, 8 KB SRAM in RTC and external Quad SPI/QPI 16 MB flash



Connectivity

- 2.4 GHz Wi-Fi 802.11 b/g/n with HT20 / HT40
- Bluetooth 5 (LE) with Long Range support
- Wi-Fi and Bluetooth LE mesh support



Peripherals

- 22 programmable GPIOs: UART, SPI, I²C, I²S, PWM, ADC, TWAI, Full-speed USB Serial/JTAG controller



Security

- RSA-3072-based secure boot
- AES-128/256-XTS-based flash encryption
- Digital signature peripheral and the HMAC peripheral
- Hardware acceleration support for cryptographic algorithms

Applications

- Smart home (Light-control system)
- Industrial automation
- Health care
- Consumer electronics
- Generic low-power IoT sensor hubs
- Generic low-power IoT data loggers

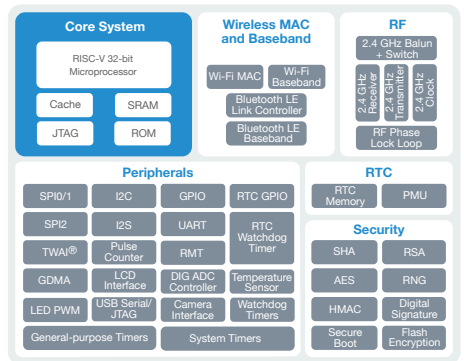

ESP32-C3 Block Diagram

Highlights

RISC-V at the Core

- ESP32-C3 integrates a 32-bit core RISC-V microcontroller with a maximum clock speed of 160 MHz.
- With 22 configurable GPIOs, 400 KB of internal RAM and low-power-mode support, it can facilitate many different use cases involving connected devices.
- The MCU comes in multiple variants with integrated and external flash availability.

2.4 GHz Wi-Fi + Bluetooth 5 (LE)

- IEEE 802.11 b/g/n-compliant; Supports 20 MHz, 40 MHz bandwidth in 2.4 GHz band; 1T1R mode with a data rate of up to 150 Mbps
- Bluetooth 5 (LE); Bluetooth mesh; Advertising extensions

Learn More: [espressif.com](https://www.espressif.com)
 Product Selector: [espressif.com/product-selector](https://www.espressif.com/product-selector)
 Contact Us: [espressif.com/sales](https://www.espressif.com/sales)

ESP32-32

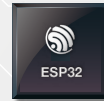

A Feature-Rich MCU with Integrated Wi-Fi and Bluetooth Connectivity for a Wide Range of Applications

Features



CPU & Memory

- Xtensa® 32-bit LX6 single-/dual-core processor that operates at up to 600 MIPS
- 448 KB ROM, 520 KB SRAM, 16 KB SRAM in RTC, QSPI supports multiple flash/SRAM chips



Connectivity

- 2.4 GHz Wi-Fi 802.11 b/g/n with HT20 / HT40
- Bluetooth 4.2 (BR/EDR + LE)
- Wi-Fi and Bluetooth LE mesh support



Peripherals

- 34 programmable GPIOs: UART, SPI, I²C, I²S, ADC, DAC, TWAI, LED PWM, touch sensor, hall sensor



Security

- Secure boot, flash encryption, cryptographic hardware acceleration

Applications

- Smart home
- Industrial automation
- Wearable electronics
- Retail & catering applications
- Image recognition
- Speech recognition
- Mesh network

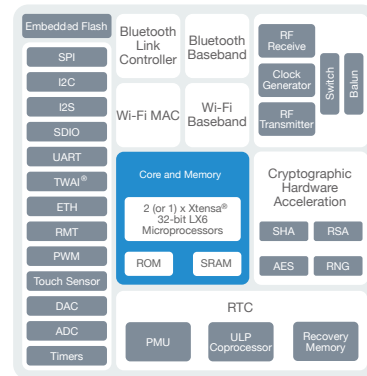

ESP32 Block Diagram

Highlights

High Level of Integration

- ESP32 is highly integrated with in-built antenna switches, RF balun, power amplifier, low-noise-receive amplifier, filters, and power management modules.

Low Power

- ESP32 features all the state-of-the-art characteristics of low-power chips, including fine-grained clock gating, multiple power modes, and dynamic power scaling.

Learn More: [espressif.com](https://www.espressif.com)
 Product Selector: [espressif.com/product-selector](https://www.espressif.com/product-selector)
 Contact Us: [espressif.com/sales](https://www.espressif.com/sales)

ESP 8266

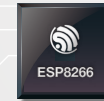

A Cost-Effective and Highly Integrated Wi-Fi MCU for IoT Applications

Features



CPU & Memory

- Xtensa® 32-bit L106 single-core processor that operates at up to 160 MHz
- 64 KB ROM, 160 KB SRAM, SPI/QSPI supports multiple flash/SRAM chips



Connectivity

- 2.4 GHz Wi-Fi 802.11 b/g/n with HT20



Peripherals

- 17 programmable GPIOs: UART, SPI, I²C, I²S, PWM, ADC, IR remote control

Applications

- Smart home
- Industrial automation
- Smart plugs and lights
- Wearable electronics
- IP cameras
- Wi-Fi geolocation
- Wi-Fi position system beacons

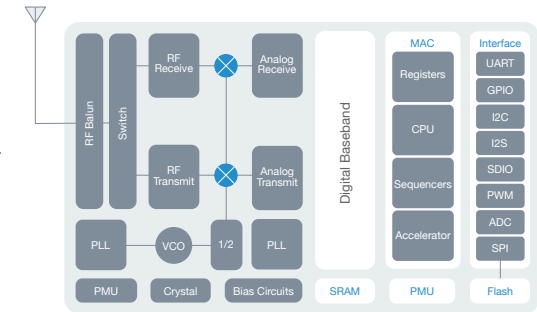

ESP8266 Block Diagram

Highlights

High Level of Integration

- ESP8266 integrates antenna switches, RF balun, power amplifier, low-noise receive amplifier, filters and power management modules. The compact design of ESP8266 minimizes the PCB size and requires only a few external circuitries.

Master/Slave

- ESP8266 can perform either as a standalone SoC or as slave to a host MCU. When ESP8266 hosts the application, it promptly boots up from the flash. Also, it can be applied to any microcontroller design as a Wi-Fi adaptor through the SPI/SDIO or UART interfaces.

Learn More: [espressif.com](https://www.espressif.com)
 Product Selector: [espressif.com/product-selector](https://www.espressif.com/product-selector)
 Contact Us: [espressif.com/sales](https://www.espressif.com/sales)



ESP-AVS

The ESP-Voice-Assistant SDK provides an implementation of Amazon's Alexa Voice Service, Google Voice Assistant and Google Dialogflow for the ESP32 microcontroller. This facilitates developers in running directly these voice-assistants on ESP32. The SDK will run on hardware boards that have a Microphone/Speaker interfaced with the ESP32.



Hardware:

- The SDK supports the **ESP32-Vaquita-DSPG** and **ESP32-LyraTD-DSPG** development boards. The ESP32-Vaquita-DSPG development board, together with Alexa Voice Service (AVS) for AWS IoT, provides a turnkey solution to easily creating Alexa built-in IoT devices, with voice enablement and AWS IoT Cloud connectivity.
- Supports acoustic front-end including DSPG DBMD5P, Intel s1000 and Synaptics CX20921.



SDK: The SDK contains pre-built libraries for Amazon Alexa, Google Voice Assistant (GVA) and Google Dialogflow along with sources of utility components such as audio pipeline and connection manager.

ESP AVS for AWS IoT

Espressif provides a certified solution for Alexa-built-in devices with the AVS for AWS IoT SDK protocol. The ESP32-WROVER-E series of modules, in combination with an external DSP, provides the industry's most cost-effective, yet feature-rich, solution. The availability of the device and its companion phone app SDKs reduce development effort significantly.

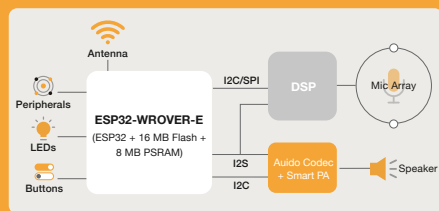

Hardware Architecture

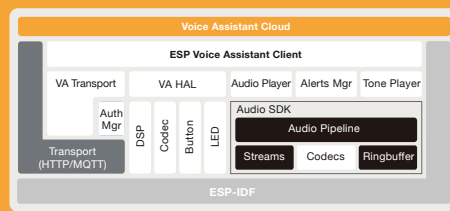

SDK Architecture



Hardware: ESP32-Vaquita-DSPG provides a reference design for Alexa-built-in connected devices, along with schematics, layout and BOM.



SDK: Espressif's AVS for AWS IoT SDK provides production-ready example applications that include full AVS for the AWS IoT SDK functionality, including music service support.

ESP AVS: github.com/espressif/esp-va-sdk

ESP AVS for AWS IoT: espressif.com/solutions/audio-solutions/esp-avs-for-aws-iot



ESP Audio Front-End Algorithms

Espressif has created a set of audio front-end (AFE) algorithms that result in a solid voice-controlled performance even in noisy environments. Customers can use these algorithms with Espressif's powerful ESP32 and ESP32-S3 SoCs, in order to build high-performance, yet low-cost, products with a voice-user interface. Espressif's AFE algorithms have been **qualified by Amazon as a "Software Audio Front-End" solution for Alexa** built-in devices.

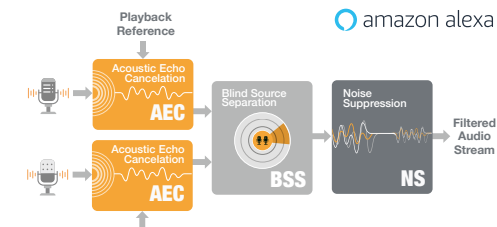

Outstanding Acoustic Performance: In most cases, the wake-up rate achieves 100%, and the speech recognition rate is over 90% in low-SNR scenarios.



Resource Efficiency: Utilizing just 12-20% of CPU, and consuming around 460 KB of memory, including 220 KB of internal memory and 240 KB of external memory.



Flexibility: Offering an easy and intuitive API. The distance between the two microphones can be between 20-80 mm.

ESP-Skainet

Espressif's offline smart-voice assistant currently supports a configurable wake-word engine (WakeNet), and an offline speech-recognition engine (MultiNet) with up to **200+** offline commands and acoustic algorithms.

Hi Espressif, turn on the light.

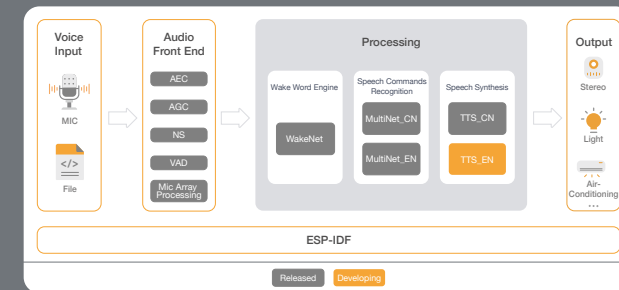

ESP AFE: espressif.com/solutions/audio-solutions/esp-afe

ESP-Skainet: espressif.com/solutions/audio-solutions/esp-skainet/overview

Audio Solutions



Face Recognition

ESP32-S3-BOX AI Voice Development Kit

ESP32-S3-BOX provides a platform for developing the control of smart devices with offline and online voice assistants. It is ideal for developing AIoT applications with reconfigurable AI voice functions, such as smart speakers, and IoT devices that achieve human-computer voice interaction directly.



Voice Assistant



Touch Screen Control



Sensor



Infrared Remote Control



Smart Gateway

ESP32-S3-BOX combines a touch screen controller, various sensors, an infrared controller and a smart gateway. With all this functionality and its product-ready form factor, ESP32-S3-BOX will help you save significant R&D expenses, and shorten the development cycle of your product.

Highlights

- **Online and Offline Voice Assistant:** ESP32-S3-BOX is equipped with Espressif's AI Voice Recognition system, with which you can customize the command phrases for giving instructions.
- **HMI Touch Screen:** 320 x 240 capacitive touch screen, Integrated LVGL in SDK
- **Smart Gateways:** Thread Border Router, Zigbee gateway, Wi-Fi/Bluetooth gateway, Wi-Fi hotspot
- **Extensible Pmod™ Interface:** Providing two Pmod™-compatible headers (with 16 programmable GPIOs) that support interfacing with various peripherals for flexibly expanding the functions of the board.

ESP32-S3-BOX: github.com/espressif/esp-box

ESP-WHO

ESP-WHO is a face detection and recognition development framework based on ESP32. You can use it with the **ESP-EYE** or the **ESP-WROVER-KIT** development board. Then, by adding only a few peripherals, such as cameras and screens, you can easily create complete AIoT applications.

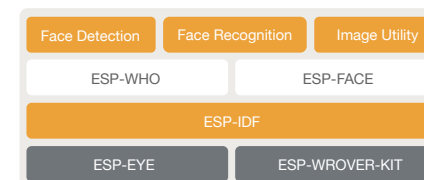

Security
Local memory



Cost-Effectiveness



High Performance
10 frames per second



Expandability

- Object detection
- Object tracking
- Hand-gesture recognition

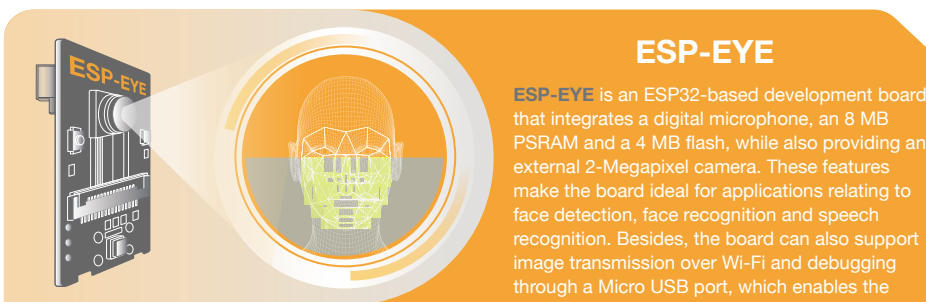

ESP-EYE

ESP-EYE is an ESP32-based development board that integrates a digital microphone, an 8 MB PSRAM and a 4 MB flash, while also providing an external 2-Megapixel camera. These features make the board ideal for applications relating to face detection, face recognition and speech recognition. Besides, the board can also support image transmission over Wi-Fi and debugging through a Micro USB port, which enables the development of advanced AI solutions.

ESP32-S3-EYE is based on the ESP32-S3 SoC. It features a 2-Megapixel camera, an LCD display, and a microphone, which are used for image recognition and audio processing. ESP32-S3-EYE offers plenty of storage, with an 8 MB Octal PSRAM and a 8 MB flash.



ESP-EYE is an AWS-qualified development board. In addition to Espressif's own ESP-IDF SDK, you can use FreeRTOS on ESP-EYE. This development board can also be used with FreeRTOS for simple camera and audio capture use-cases. It provides out-of-the-box connectivity with AWS-IoT and other AWS services.

ESP-WHO: espressif.com/products/devkits/esp-eye/overview

ESP-EYE: github.com/espressif/esp-who/blob/master/docs/en/get-started/ESP-EYE_Getting_Started_Guide.md

ESP32-S3-EYE: github.com/espressif/esp-who/blob/master/docs/en/get-started/ESP32-S3-EYE_Getting_Started_Guide.md

ESP-HMI



ESP-MESH

ESP-HMI is Espressif's high-performance and low-cost solution for achieving a smart interaction between users and AIoT devices. It has an innovative user-interface which enables data visualization, touch or gesture control, voice recognition, image recognition and analysis, etc.

ESP32-S2 and **ESP32-S3** can support high-performance HMI applications through optimized display and improved external memory (SPIRAM).



ESP-LCD

A multimedia smart-control solution built around ESP32-S2-HMI-DevKit-1 and an LCD capacitive touch screen. With ESP-LCD, users can easily realize a hardware network, and achieve remote or smart-touch control, data visualization, music playback, recording, etc.



The 4.3-inch TFT-LCD supports up to a 480 × 800 resolution



Initial start-up time is less than 200 ms



Supporting LVGL GUI development, music playback, and recording



Ultra-low-power consumption



ESP-Touch

A smart-touch solution based on ESP32-S2-Touch-DevKit-1, which is a board for evaluating and developing different button functions, linear sliders, two-dimensional touch panels, proximity sensors, etc.

14 GPIOs

ESP32-S2 and ESP32-S3 feature 14 capacitive touch GPIOs



Waterproof surface



Unified and user-friendly APIs in the ESP32-S2 Touch Element library



Ultra-low-power consumption



ESP-HMI: espressif.com/solutions/hmi/esp-hmi

ESP-WIFI-MESH

ESP-WIFI-MESH is an ad-hoc network based on a Wi-Fi communication protocol that allows multiple devices (or nodes), distributed over a large physical area, to get interconnected under a single WLAN.

ESP-MDF, or Espressif's Mesh Development Framework, is a development framework for ESP-WIFI-MESH. Its function materializes network configuration, firmware upgrade, debugging, LAN control and various application demos.

AWS	Aliyun
ESP-MDF	
Basic Components	ESP-NOW
ESP-WIFI-MESH	
ESP-IDF	
ESP32-Mesh Kit	ESP32-Sense Kit



Easy and secure setup



Self-forming and self-healing



Network with standard security



No extra gateways required



ESP-BLE-MESH

ESP-BLE-MESH is an open-source protocol stack based on Zephyr Bluetooth® mesh. It supports almost all core features, client models, and server models specified in the Bluetooth mesh protocol, currently making it one of the most full-featured, open-source, Bluetooth mesh protocol implementations.



Fully SIG-qualified



Industrial-grade security



Fast distribution network



Supports friend feature and low-power feature



Supports coexistence with Wi-Fi & BR/EDR & Bluetooth LE



Supports large-scale networks, without routing tables

ESP-WIFI-MESH: espressif.com/products/sdks/esp-wifi-mesh/overview

ESP-BLE-MESH: espressif.com/products/sdks/esp-idf/esp-ble-mesh

Device Connectivity



ACK Solution

ESP32-PICO-V3-ZERO, the Alexa Connect Kit (ACK) module with an Espressif chipset, and its related development kit **ESP32-PICO-V3-ZERO-DevKit** provide an easy way for customers to build Alexa-connected devices without worrying about writing an Alexa Skill and managing Cloud services, phone applications or complex device firmware. Espressif's ACK Solution provides Alexa connectivity and support features, such as Frustration-Free Setup and Amazon Dash Replenishment.

Software

ESP32-PICO-V3-ZERO comes pre-programmed with the ACK module firmware. It is also pre-provisioned with credentials for connecting to an ACK-managed Cloud service. The ACK module firmware is managed by Amazon and provides out-of-the-box features such as Frustration-Free Setup, Alexa connectivity and Amazon Dash Replenishment.



ACS Solution

Amazon Common Software (ACS) for Devices is Amazon's optimized software that simplifies the integration of various Amazon Device SDKs in your connected products. Espressif's ESP32 SoC is a qualified platform for ACS, supporting it with a stable and production-ready Device Porting Kit (DPK). With the ESP32 DPK, developers can implement the required API for accessing device hardware, as well as for operating system APIs and connectivity features. Combining the ESP32 DPK implementation with the ACS middleware and the Amazon Device SDKs provides a well-maintained and well-tested development platform for your application.

Espressif provides a comprehensive software package that includes Espressif's Alexa for AWS IoT (AFI) SDK, a Frustration-Free Setup Device SDK, ACS middleware, Espressif's DPK implementation, and an example application. **ESP32-Vaquita-DSPG** is a development board that can be used as a hardware platform for running the application based on this software.

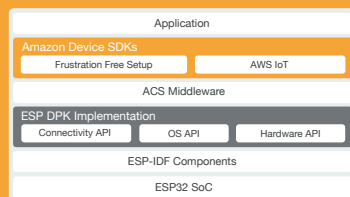

ACK: espressif.com/solutions/device-connectivity/ack-solution

ACS: espressif.com/solutions/device-connectivity/acs-solution



Device Connectivity

ESP AWS IoT ExpressLink Solution

Espressif's AWS IoT ExpressLink module (ESP32-C3-MINI-1-N4-A) is based on the ESP32-C3 Wi-Fi + Bluetooth 5 (LE) SoC, which provides host MCUs with out-of-the-box, seamless, AWS IoT connectivity, while also implementing the AWS IoT ExpressLink specification.

ESP32-C3-MINI-1-N4-A has a simple serial interface through which the host MCU gets connected to AWS IoT services, thus transforming any offline product into a Cloud-connected product. Espressif's AWS IoT ExpressLink Module handles complex, yet undifferentiated, workload, such as authentication, device management, connectivity, messaging and OTA. Thus, it relieves developers from developing and maintaining complex firmware, while it provides end-to-end security and fleet management at scale.

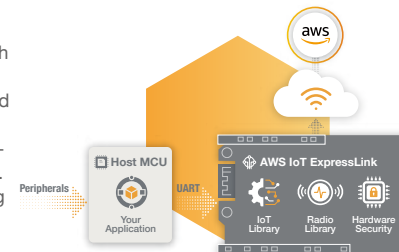

Software Features

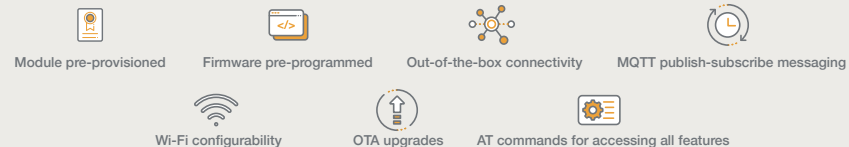

Hardware Features

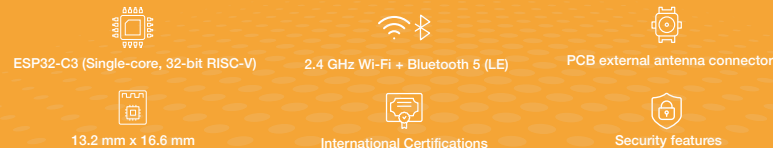

ESP32-C3-AWS-ExpressLink-DevKit

The ESP32-C3-AWS-ExpressLink-DevKit is a development board that hosts Espressif's AWS IoT ExpressLink module. It can be used with an external host MCU for easy evaluation and prototyping. The pin layout of ESP32-C3-AWS-ExpressLink-DevKit is compatible with that of the Arduino Zero development board and, therefore, it can be directly plugged into the Arduino Zero board, or be easily connected to other host MCUs, such as the Raspberry Pi.



ESP AWS IoT ExpressLink: espressif.com/solutions/device-connectivity/esp-aws-iot-expresslink

AWS IoT ExpressLink: aws.amazon.com/iot-expresslink

ESP Insights



ESP Insights is a device observability framework that allows developers to remotely peek into their firmware, and get information about the firmware execution. This information can then be used for analysing any issues and getting a deeper understanding of any problematic areas. Such a data-collecting observation should help organisations save valuable engineering resources, allowing them to speed up firmware development and fix any issues within a short time.

ESP Insights

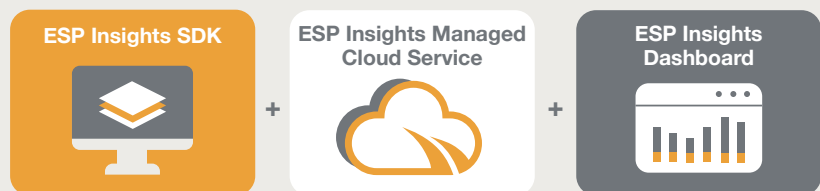

Features

- Observing **critical logs and errors** that the firmware has generated during its execution.
- In case of a **firmware crash**, users can observe **the register dump and the backtrace**, in order to understand the root cause of the failure.
- Examining the **device timeline** to find out events of interest and their sequence.
- Adding **custom events** to the timeline.
- Observing **firmware metrics** that consist of common system parameters such as free heap, largest free memory block etc.
- Defining and viewing certain **variables of interest**.



ESP Insights: github.com/espressif/esp-insights



Espressif's Customer Support

Espressif supports customers, all the way from design to certification and manufacturing.

Open-Source Documentation



- Datasheets, technical reference manuals, user guides, API references, and test reports are accessible for free.
- Official forums where user requests and questions are answered by Espressif engineers.

Open-Source Software



- ESP-IDF, ESP-ADF, ESP-MDF, ESP-WHO and ESP-Skainet development frameworks are accessible for free.
- ESP-IoT-Solution, which contains device drivers and code frameworks for IoT development, is available to anyone.

RF Design Review and Assistance



- PCBA proofing, RF designing, RF matching, debugging, and RF testing are provided to our customers.



Hardware Resources and Reviewing Services



- Reference designs and hardware design guidelines
- Free-of-charge schematic and PCB reviewing
- Response in 1-3 working days

Manufacturing



- Pre-provisioned modules with device certificates
- Customized services such as flash programming, MAC address, etc.

On-Site Support



- In certain cases, technical support may be provided directly on customer premises by Espressif's most qualified engineers.

By choosing our products and services, you get to concentrate on your design, and bring your product to life quickly, efficiently and securely.

 **Contact us:** espressif.com/sales





Disclaimer and Copyright Notice

- Information in this brochure, including URL references, is subject to change without notice.
- All third-party information in this brochure is provided as is with no warranty to its authenticity and accuracy.
- No warranty is provided for this brochure about its merchantability, non-infringement of any proprietary rights, fitness for any particular purpose, nor does any warranty otherwise arise out of any proposal, specification or sample.
- All liability, including liability for infringement of any proprietary rights, relating to use of information in this brochure is disclaimed. No licenses express or implied, by estoppel or otherwise, to any intellectual property rights are granted herein.
- The Wi-Fi Alliance Member logo is a trademark of the Wi-Fi Alliance. The Bluetooth logo is a registered trademark of Bluetooth SIG.
- All trade names, trademarks and registered trademarks mentioned in this document are property of their respective owners, and are hereby acknowledged.

X-ON Electronics

Largest Supplier of Electrical and Electronic Components

Click to view similar products for [Data Conversion IC Development Tools](#) category:

Click to view products by [Espressif](#) manufacturer:

Other Similar products are found below :

[EVAL-AD5063EBZ](#) [EVAL-AD5373EBZ](#) [EVAL-AD5422LFEBZ](#) [EVAL-AD7641EDZ](#) [EVAL-AD7674EDZ](#) [EVAL-AD7690SDZ](#) [EVAL-AD7719EBZ](#) [EVAL-AD7995EBZ](#) [AD9122-M5372-EBZ](#) [AD9211-200EBZ](#) [AD9251-20EBZ](#) [AD9251-65EBZ](#) [AD9255-125EBZ](#) [AD9284-250EBZ](#) [AD9613-170EBZ](#) [AD9627-125EBZ](#) [AD9629-20EBZ](#) [AD9709-EBZ](#) [AD9737A-EBZ](#) [AD9787-DPG2-EBZ](#) [AD9993-EBZ](#) [DAC8555EVM](#) [ADS5482EVM](#) [ADS8372EVM](#) [EVAL-AD5061EBZ](#) [EVAL-AD5760SDZ](#) [EVAL-AD7450ASDZ](#) [EVAL-AD7677EDZ](#) [EVAL-AD7994EBZ](#) [EVAL-AD7997EBZ](#) [AD9119-MIX-EBZ](#) [AD9148-M5375-EBZ](#) [AD9204-80EBZ](#) [AD9233-125EBZ](#) [AD9251-80EBZ](#) [AD9265-105EBZ](#) [AD9608-125EBZ](#) [AD9629-80EBZ](#) [AD9648-125EBZ](#) [AD9649-20EBZ](#) [AD9650-80EBZ](#) [AD9717-DPG2-EBZ](#) [AD9765-EBZ](#) [AD9778A-DPG2-EBZ](#) [ADS8322EVM](#) [LM96080EB/NOPB](#) [EVAL-AD7687SDZ](#) [AMC7823EVM](#) [EVAL-ADE7763ZEB](#) [MAX5550EVKIT+](#)