



# ESPRESSIF

## Social Media

- twitter.com/EspressifSystem
- facebook.com/espressif
- linkedin.com/company/espressif-systems
- youtube.com/EspressifSystems
- instagram.com/espressif\_systems\_official

## Official Platform

- www.espressif.com
- blog.espressif.com
- github.com/espressif
- devcon.espressif.com
- esp32.com
- esp8266.com
- bbs.espressif.com

## Espressif Systems

SHARE :: CONNECT :: INNOVATE



## Espressif

A World-leading  
AIoT Solution  
Platform

## Solutions

- ESP RainMaker
- Matter
- ESP-HMI
- ESP-MESH
- ESP-NOW
- ESP Insights
- Audio Solutions
- Face Recognition
- Device Connectivity

## Products

### Software

### Hardware

# INNOVATING THE TECHNOLOGIES OF TOMORROW

## Support

Customer Support

- ESP-IDF
- Espressif's SDK for Matter
- Hosted-Mode SDKs
- Audio Development Framework
- IoT Cloud Connectors
- AI and Machine Learning SDK

- ESP32-C
- ESP32-S
- ESP32-H
- ESP32-P
- ESP32
- ESP8266

# Contents

---



## About

About Espressif .....	01
Global Ecosystem .....	03



## ESP Products

### Software

Espressif's Software Platform .....	05
-------------------------------------	----

### Hardware

ESP Series of SoCs .....	08
--------------------------	----



## ESP Solutions

ESP RainMaker .....	17
Matter .....	19
ESP-HMI .....	21
ESP-MESH .....	22
ESP Smart Switch .....	23
ESP-NOW .....	24
ESP Insights .....	25
Audio Solutions .....	26
Face Recognition .....	29
Device Connectivity .....	30



## Support

Espressif's Customer Support .....	33
------------------------------------	----

# About Espressif

## A World-Leading AIoT Platform

Espressif Systems (688018.SH) is a public, multinational, fables, semiconductor company established in 2008. We have a passionate team of engineers and scientists from all over the world, focused on developing cutting-edge, yet cost-effective, SoCs that achieve low-power, wireless communication. Espressif is proud of its high-performance hardware, as well as its development frameworks which are designed in-house from the ground up. Espressif provides millions of users with a variety of secure AIoT solutions relating to facial recognition, voice interaction, mesh networking, human interaction and Cloud connectivity, across the whole wide world.

### 1st

Global Wi-Fi MCU market share



Products distributed all over the world

800 M+

Products powering over 800 million AIoT devices worldwide



### China

- Shanghai
- Wuxi
- Shenzhen
- Suzhou
- Hefei

### India

- Pune

### Czech Republic

- Brno

### Brazil

- Campinas

### Singapore

## Espressif's Worldwide Expansion

## Vision and Mission

Espressif is committed to providing open-source AIoT solutions to its customers and developers, commercial and non-commercial alike, so that developers from all walks of life can use this technology to solve some of the most pressing problems of our times.



## A Complete-Solution Provider

ESP RainMaker® for accelerating AIoT business with own platform, ESP-ADF for voice recognition, ESP-WHO for face detection and recognition, and ESP-MDF for mesh connectivity.

ESP-IDF integrates a real-time operating system with drivers for peripherals, network protocol stacks for Wi-Fi and Bluetooth, as well as various utility libraries and development tools.

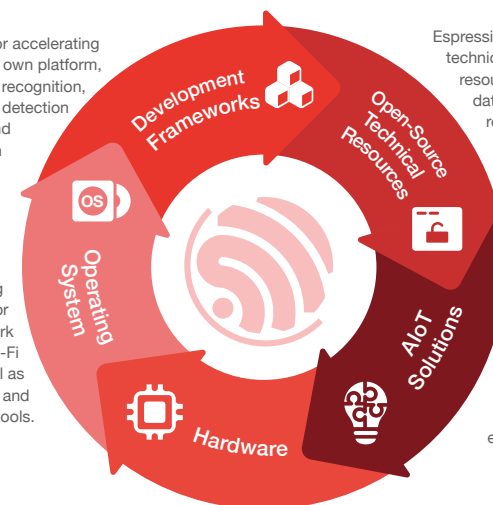

Espressif offers a variety of technical documents and resources for free, including datasheets, technical reference manuals, user guides, API references, test reports, etc.

Espressif provides audio, face recognition, HMI, device-connectivity solutions, which are widely used in the areas of smart home, industrial control, consumer electronics, etc.

High-performance Wi-Fi + Bluetooth / Bluetooth LE + IEEE 802.15.4 + AI SoCs, Modules and DevKits, including the ESP8266, ESP32, ESP32-S, ESP32-C and ESP32-H Series.

# Global Ecosystem

## Development Platforms

ESP-IDF is Espressif's open-source and field-proven platform that already powers millions of connected devices. Espressif also contributes to open-source, real-time operating systems, such as NuttX and Zephyr, thus giving developers more choice when creating their own applications.

Espressif's products are also compatible with Arduino IDE, Amazon FreeRTOS, NodeMCU, MicroPython, PlatformIO, and Mongoose OS.

## Third-Party Cloud Platforms



40+ mainstream Cloud platforms support Espressif products

## Active Community Engagement

**80 K+**  
80 K+ open-source, Espressif-powered projects on GitHub

**3.4 M+**  
3.4 M+ views for the most popular videos of Espressif-powered projects on YouTube

**100+**  
Book

100+ books written about Espressif's SoCs in 10+ languages

**58 K**  
Reddit

58 K+ members of ESP32 groups on Reddit

# Hardware and Software

## Innovating for Quality

Espressif is the first company to have successfully integrated an antenna switch, RF balun, power amplifier, low-noise receive amplifier, filters, and power-management modules for Wi-Fi applications in CMOS technology. As such, the entire solution occupies a minimal Printed Circuit Board (PCB) area.



Small and simple design

Improved yield and high reliability

Low cost

Minimal manufacturing and logistical complexity

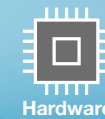

## Unlocking the Potential of the AIoT Development

Espressif has already left an indelible mark on the IoT industry and maker communities worldwide, having built a modern software platform which is based on the community-driven development of its powerful wireless MCUs. Espressif's SDKs provide toolchains, APIs, components and workflows for fast, secure and cost-effective application development, while Espressif's SoCs are compatible with all the main operating systems, such as Windows, Linux and MacOS. This way, developers can easily use the Espressif SDK of their preference to build new AIoT applications, or migrate their existing applications to the ESP hardware platform of their choice. As a result, Espressif SoCs have already powered millions of devices in the field, and are recognized as the driving force of innovation in the AIoT industry.

# Espressif's Software Platform

## ESP-IDF

**ESP-IDF** is Espressif's official IoT Development Framework for the ESP32, ESP32-S, ESP32-C and ESP32-H series of SoCs. It provides a self-sufficient SDK for any generic application development on these platforms, using programming languages such as C and C++. ESP-IDF currently powers millions of devices in the field, and enables building a variety of network-connected products, ranging from simple light bulbs and toys to big appliances and industrial devices.



### ESP-IDF

Network Provisioning	OTA Upgrade Library	Manufacturing Utilities	Common Networking Protocols	Examples	
File Systems	Object Storage	POSIX and C++ Support	Network Security	Crypto Library	IDE Plugins
Peripherals Drivers	Power Management	Wi-Fi & Bluetooth LE Mesh Networking	TCP/IP Stack	Bluetooth/Bluetooth LE Stack	Build System
RTOS Kernel	SoC Support	Software Bootloader	Wi-Fi MAC Library	Bluetooth Controller	Developer Tools

**ESP-IDF:** [github.com/espressif/esp-idf](https://github.com/espressif/esp-idf)

## Hosted-Mode SDKs

### ESP-AT

SDK based on an AT command set for the network connectivity of host MCUs.

### ESP-Hosted

Native network interface SDK for the network connectivity of MCU & Linux hosts.

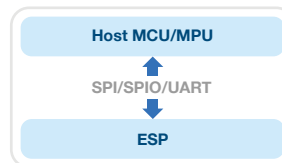

**ESP-AT:** [github.com/espressif/esp-at](https://github.com/espressif/esp-at)

**ESP-Hosted-FG (MCU & Linux host):** [github.com/espressif/esp-hosted#12-esp-hosted-fg](https://github.com/espressif/esp-hosted#12-esp-hosted-fg)

**ESP-Hosted-NG (Linux host only):** [github.com/espressif/esp-hosted#11-esp-hosted-ng](https://github.com/espressif/esp-hosted#11-esp-hosted-ng)

## Audio Development Framework



### ESP-ADF

This is an SDK for building audio applications with Espressif SoCs. This includes audio pipelining, a variety of codecs, containers, playlist parsers and higher-level audio protocols.

**ESP-ADF:** [github.com/espressif/esp-adf](https://github.com/espressif/esp-adf)

## IoT Cloud Connectors

**ESP RainMaker®:** [github.com/espressif/esp-rainmaker](https://github.com/espressif/esp-rainmaker)

**AWS IoT:** [github.com/espressif/esp-aws-iot](https://github.com/espressif/esp-aws-iot)

**Google Cloud IoT Core:** [github.com/espressif/esp-google-iot](https://github.com/espressif/esp-google-iot)

**Microsoft Azure IoT:** [github.com/espressif/esp-azure](https://github.com/espressif/esp-azure)

**Joylink IoT Cloud:** [github.com/espressif/esp-joylink](https://github.com/espressif/esp-joylink)

**Aliyun IoT Cloud:** [github.com/espressif/esp-aliyun](https://github.com/espressif/esp-aliyun)

**Tencent IoT Cloud:** [github.com/espressif/esp-qcloud](https://github.com/espressif/esp-qcloud)

**Baidu IoT Core:** [github.com/espressif/esp-baidu-iot](https://github.com/espressif/esp-baidu-iot)



## AI and Machine Learning SDK

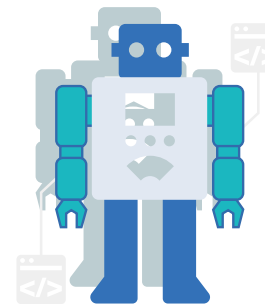

### ESP-DL

This is an SDK that implements an optimized kernel, various models, model conversion tools and hardware acceleration implementation for Espressif SoCs.

**ESP-DL:** [github.com/espressif/esp-dl](https://github.com/espressif/esp-dl)

# Espressif's Series of SoCs

Espressif drives the development of AIoT solutions, with its complete MCUs featuring integrated Wi-Fi, Bluetooth and IEEE 802.15.4 connectivity.

	Connectivity	Core	RAM	GPIO
 ESP32-S2	 2.4 GHz Wi-Fi 4	Xtensa® LX7 32-bit Single Core	320 KB	43
<b>AI Accelerator</b>				
 ESP32-S3	 2.4 GHz Wi-Fi 4  Bluetooth 5 (LE)	Xtensa® LX7 32-bit Dual Core	512 KB	45
 ESP32-C2	 2.4 GHz Wi-Fi 4  Bluetooth 5 (LE)	RISC-V 32-bit Single Core	272 KB	14
 ESP32-C3	 2.4 GHz Wi-Fi 4  Bluetooth 5 (LE)	RISC-V 32-bit Single Core	400 KB	22
 ESP32-C5	 2.4 / 5 GHz Wi-Fi 6  Bluetooth 5 (LE)  Thread  Zigbee	RISC-V 32-bit Single Core	512 KB	20+
 ESP32-C6	 2.4 GHz Wi-Fi 6  Bluetooth 5 (LE)  Thread  Zigbee	RISC-V 32-bit Single Core	512 KB	30 or 22
 ESP32-H2	 Bluetooth 5 (LE)  Thread  Zigbee	RISC-V 32-bit Single Core	320 KB	19
 ESP32-P4	/	RISC-V 32-bit Dual Core	768 KB	50+
 ESP32	 2.4 GHz Wi-Fi 4  Bluetooth 4.2 (BR/EDR + LE)	Xtensa® LX6 32-bit Single/Dual Core	520 KB	34
 ESP8266	 2.4 GHz Wi-Fi 4	Tensilica® L106 32-bit Single Core	160 KB	17



**Learn More**  
espressif.com



**Product Selector**  
espressif.com/product-selector



**Contact Us**  
espressif.com/sales

# ESP32-S2

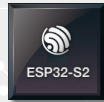

A Secure and Powerful Wi-Fi MCU with Numerous I/O Capabilities

## Features



### CPU & Memory

- Xtensa® 32-bit LX7 single-core processor that operates at up to 240 MHz
- 128 KB ROM, 320 KB SRAM, 16 KB SRAM in RTC, SPI/QSPI/OSPI supports multiple flash and external RAM chips



### Connectivity

- 2.4 GHz Wi-Fi 802.11 b/g/n with HT20 / HT40



### Peripherals

- 43 programmable GPIOs: UART, SPI, I<sup>2</sup>C, I<sup>2</sup>S, ADC, DAC, TWAI, LED PWM, LCD interface, camera interface, USB OTG, 14 capacitive Touch GPIOs



### Security

- RSA-3072-based secure boot
- AES-128/192/256-XTS-based flash encryption
- Cryptographic accelerators for enhanced performance
- Protected private key and device encryption preventing outsiders from software access
- Protection against physical fault injection attacks

## Applications

- Human machine interface (HMI)
- Cameras for video streaming
- Generic low-power IoT sensor hubs
- Generic low-power IoT data loggers
- Image recognition
- Speech recognition
- Smart home
- Industrial automation

## Highlights

### HMI Solution

- With an LCD interface and 14 configurable capacitive touch GPIOs, ESP32-S2 provides the optimal HMI solution to touchscreen and touchpad-based devices.

### Unparalleled Security

- AES, SHA and RSA algorithms integrated into cryptographic accelerators.
- Additional hardware security features are provided by the RNG, HMAC and Digital Signature modules, along with flash encryption and secure boot signature verification features.

### Low Power

- ESP32-S2's fine-grained clock gating, dynamic voltage and frequency scaling, together with its adjustable power amplifier output power contribute to an optimal trade-off between communication range, data rate and power consumption.

Learn More: [espressif.com](https://www.espressif.com)  
 Product Selector: [espressif.com/product-selector](https://www.espressif.com/product-selector)  
 Contact Us: [espressif.com/sales](https://www.espressif.com/sales)

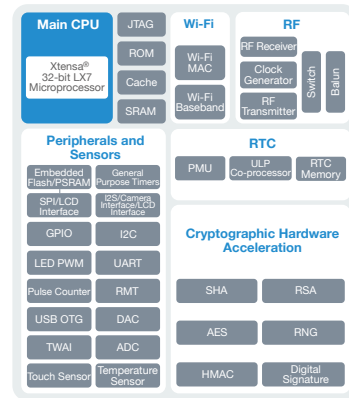

ESP32-S2 Block Diagram

# ESP32-S3

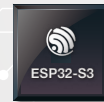

A Wi-Fi and Bluetooth 5 (LE) MCU Designed for AIoT Applications with Powerful AI Acceleration and Reliable Security Features

## Features



### CPU & Memory

- Xtensa® 32-bit LX7 dual-core processor with a five-stage pipeline that operates at up to 240 MHz
- 384 KB ROM, 512 KB SRAM, external Quad SPI/Octal SPI/QPI/OPI 1GB flash and 1GB RAM



### Connectivity

- 2.4 GHz Wi-Fi 802.11 b/g/n with HT20 / HT40
- Bluetooth 5 (LE) with Long Range support
- Wi-Fi and Bluetooth LE mesh support



### Peripherals

- 45 programmable GPIOs: UART, SPI, I<sup>2</sup>C, I<sup>2</sup>S, PWM, ADC, TWAI, 14 capacitive Touch GPIOs, USB OTG v1.1



### Security

- RSA-3072-based secure boot
- AES-128/256-XTS-based flash encryption
- Digital signature peripheral and the HMAC peripheral
- “World Controller” peripheral that provides two fully-isolated execution environments

## Applications

- Smart home
- Industrial automation
- Human machine interface (HMI)
- Touch sensing
- Speech recognition
- Image recognition
- Voice-controlled devices
- USB devices

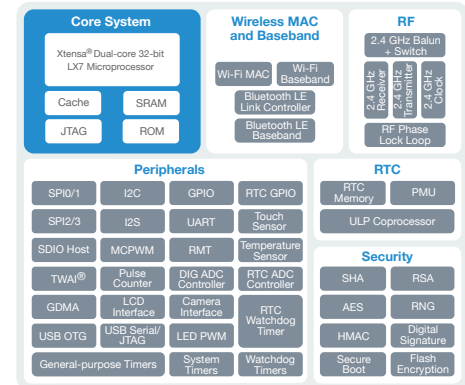

ESP32-S3 Block Diagram

## Highlights

### AI Acceleration

- Additional support for vector instructions in the MCU, which accelerates neural network computing and signal.

### Outstanding Speech-Recognition Performance

- ESP32-S3 supports the single-chip offline speech recognition solution, WakeNet, which is a configurable Wake-Word Engine.
- MultiNet: Offline-command engine that can support up to 200 offline commands.
- Espressif's Audio Front-End Algorithms for Acoustic Echo Cancellation (AEC), Blind Source Detection (BSS), and Noise Suppression (NS) contribute to a great performance even in a noisy environment.

Learn More: [espressif.com](https://www.espressif.com)  
 Product Selector: [espressif.com/product-selector](https://www.espressif.com/product-selector)  
 Contact Us: [espressif.com/sales](https://www.espressif.com/sales)



# ESP32-C2

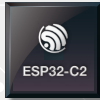

## A Small, Simple and Cheap RISC-V SoC with Robust Connectivity

### Features



#### CPU & Memory

- 32-bit RISC-V single-core processor with a four-stage pipeline that operates at up to 120 MHz
- 576 KB ROM, 272 KB SRAM (16 KB for cache)



#### Connectivity

- 2.4 GHz Wi-Fi 802.11 b/g/n, supports 20 MHz bandwidth in 2.4 GHz band
- Bluetooth 5 (LE), high power mode 20 dBm



#### Peripherals

- 14 programmable GPIOs: SPI, UART, I<sup>2</sup>C, LED PWM controller, General DMA controller (GDMA), SAR ADC, Temperature sensor



#### Security

- Secure boot
- Flash encryption
- 1024-bit OTP, up to 256 bits for use
- Cryptographic hardware acceleration: ECC, SHA Accelerator
- Random Number Generator (RNG)

### Applications

- Smart home (Light control, Smart button, Smart plug)
- Industrial automation
- Health care
- Consumer electronics
- Generic low-power IoT sensor hubs
- Generic low-power IoT data loggers

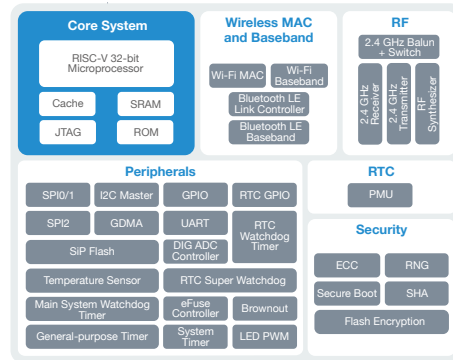

ESP8684 Block Diagram

### Highlights

#### Small and Cheap

- 4x4 mm QFN package. The die size is smaller than ESP8266.
- The ROM code of ESP32-C2 is optimized, as it reduces the need for flash.
- ESP32-C2 integrates Espressif's in-house RISC-V 32-bit single-core processor, which greatly saves IP licensing costs.

#### Enhanced RF Performance

- ESP8684 can transmit 802.11n MC7 packets (72.2 Mbps) with 18 dBm of output power.
- ESP8684 transmits at the full 20 dBm FCC limit for low data-rates.
- At "802.11b, 1 Mbps" rate, the TX power and RX Sensitivity can reach the maximum allowable boundary, maximizing the physical distance of the device.

Learn More: [espressif.com](https://www.espressif.com)  
 Product Selector: [espressif.com/product-selector](https://www.espressif.com/product-selector)  
 Contact Us: [espressif.com/sales](https://www.espressif.com/sales)

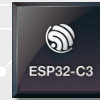

# ESP32-C3

## A Cost-Effective MCU with a RISC-V Single-Core CPU Wi-Fi and Bluetooth 5 (LE) Connectivity for Secure IoT Applications

### Features



#### CPU & Memory

- 32-bit RISC-V single-core processor with a four-stage pipeline that operates at up to 160 MHz
- 384 KB ROM, 400 KB SRAM, 8 KB SRAM in RTC and external Quad SPI/QPI 16 MB flash



#### Connectivity

- 2.4 GHz Wi-Fi 802.11 b/g/n with HT20 / HT40
- Bluetooth 5 (LE) with Long Range support
- Wi-Fi and Bluetooth LE mesh support



#### Peripherals

- 22 programmable GPIOs: UART, SPI, I<sup>2</sup>C, I<sup>2</sup>S, PWM, ADC, TWAI, Full-speed USB Serial/JTAG controller



#### Security

- RSA-3072-based secure boot
- AES-128/256-XTS-based flash encryption
- Digital signature peripheral and the HMAC peripheral
- Hardware acceleration support for cryptographic algorithms

### Applications

- Smart home (Light-control system)
- Industrial automation
- Health care
- Consumer electronics
- Generic low-power IoT sensor hubs
- Generic low-power IoT data loggers

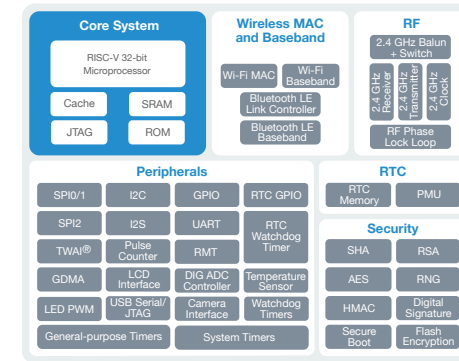

ESP32-C3 Block Diagram

### Highlights

#### RISC-V at the Core

- ESP32-C3 integrates a 32-bit core RISC-V microcontroller with a maximum clock speed of 160 MHz.
- With 22 programmable GPIOs, 400 KB of internal RAM and low-power-mode support, it can facilitate many different use cases involving connected.
- The MCU comes in multiple variants with integrated and external flash availability.

#### 2.4 GHz Wi-Fi + Bluetooth 5 (LE)

- IEEE 802.11 b/g/n-compliant; Supports 20 MHz, 40 MHz bandwidth in 2.4 GHz band; 1T1R mode with a data rate of up to 150 Mbps
- Bluetooth 5 (LE); Bluetooth mesh; Advertising extensions

Learn More: [espressif.com](https://www.espressif.com)  
 Product Selector: [espressif.com/product-selector](https://www.espressif.com/product-selector)  
 Contact Us: [espressif.com/sales](https://www.espressif.com/sales)





# ESP32-C6

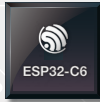

A Low-Power and Cost-Effective 2.4 GHz Wi-Fi 6 + Bluetooth 5 (LE) + Thread/Zigbee SoC, with a 32-bit RISC-V Core, for Securely Connected Devices

## Features



### CPU & Memory

- A high-performance (HP) 32-bit RISC-V processor, which can be clocked up to 160 MHz, and a low-power (LP) 32-bit RISC-V processor, which can be clocked up to 20 MHz
- 320 KB ROM, 512 KB SRAM, SPI/Dual SPI/Quad SPI/QPI supports multiple flash



### Connectivity

- 2.4 GHz Wi-Fi 802.11b/g/n/ax, supports a 20 MHz bandwidth for the 802.11ax mode and a 20/40 MHz bandwidth for the 802.11b/g/n mode
- Bluetooth 5 (LE) with Long Range support
- IEEE Standard 802.15.4-2015, supports Thread and Zigbee
- Wi-Fi and Bluetooth LE mesh support



### Peripherals

- 30 (QFN40) or 22 (QFN32) programmable GPIOs: SPI, UART, I<sup>2</sup>C, I<sup>2</sup>S, RMT, TWAI, PWM, SDIO, Motor Control PWM, ADC, Temperature sensor



### Security

- RSA-3072-based secure boot
- AES-128/256-XTS-based flash encryption
- Digital signature peripheral and the HMAC peripheral
- Trusted execution environment (TEE) controller and access permission management (APM)
- Random Number Generator (RNG)
- Hardware acceleration support for cryptographic algorithms

## Applications

- Smart home
- Industrial automation
- Health care
- Consumer electronics
- Generic low-power IoT sensor hubs
- Generic low-power IoT data loggers

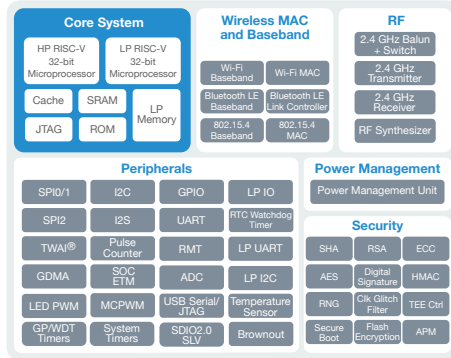

ESP32-C6 Block Diagram

## Highlights

### RISC-V at the Core

- ESP32-C6 has an integrated 2.4 GHz Wi-Fi 6 (802.11ax) radio that also supports the 802.11b/g/n standard for backward compatibility.
- It supports the OFDMA mechanism for both uplink and downlink communications, while also supporting MU-MIMO for downlink traffic. Both of these techniques allow working with high efficiency and low latency, even in congested wireless environments.
- The Target Wake Time (TWT) feature of the 802.11ax standard enables ESP32-C6 customers to build battery-operated connected devices that can last for years, while staying connected throughout.

### 2.4 GHz Wi-Fi + Bluetooth 5 (LE)

- ESP32-C6 combines 2.4 GHz Wi-Fi (802.11 b/g/n/ax), Bluetooth 5 (LE), and IEEE 802.15.4 radio connectivity, which is vital for making the Thread and Zigbee protocols available in a variety of cases of application development.
- It brings in Wi-Fi 6 features, such as transmission efficiency and low power consumption, which provide concrete benefits for IoT devices.
- Bluetooth 5 (LE) supports long-range operation through advertising extensions and coded PHY. It also supports 2 Mbps of high throughput PHY.

Learn More: [espressif.com](https://www.espressif.com)  
 Product Selector: [espressif.com/product-selector](https://www.espressif.com/product-selector)  
 Contact Us: [espressif.com/sales](https://www.espressif.com/sales)

# ESP32-H2

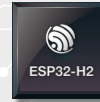

Espressif's IEEE 802.15.4 + Bluetooth 5 (LE) SoC, with a 32-bit RISC-V core, for low power consumption and secure connectivity devices

## Features



### CPU & Memory

- 32-bit RISC-V single-core processor that operates at up to 96 MHz
- 320 KB of SRAM (including 16 KB for cache), 128 KB of ROM on the chip, 4 KB LP memory, and 2 MB SiP flash inside



### Connectivity

- IEEE Standard 802.15.4-2015
- Supports Thread 1.1 (and the later versions in draft) and Zigbee 3.0
- Supports Matter and other application protocols (HomeKit, MQTT, etc)
- Bluetooth 5 (LE) with Long Range support
- Bluetooth LE mesh support



### Peripherals

- 19 programmable GPIOs: UART, SPI, I<sup>2</sup>C, I<sup>2</sup>S, Remote Control Peripheral, LED PWM, Full-speed USB Serial/JTAG Controller, GDMA, MCPWM, SoC ETM



### Security

- Secure boot
- Flash encryption
- 4096-bit OTP, up to 1792 bits for users
- Cryptographic hardware acceleration: AES-128/256, SHA Accelerator, RSA Accelerator, ECC, Digital signature, HMAC
- Random Number Generator (RNG)

## Applications

- Smart home
- Industrial automation
- Health care
- Consumer electronics

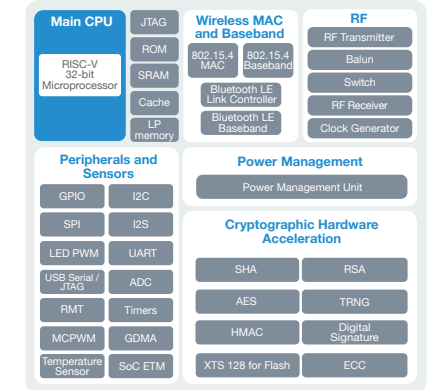

ESP32-H2 Block Diagram

## Highlights

### IEEE 802.15.4

- IEEE 802.15.4 radio connectivity has been important to the supported mesh architecture with low power consumption. ESP32-H2 will support Thread 1.1 (and the later versions in draft) and Zigbee 3.0. The availability of Thread and Zigbee protocols address a variety of application use cases.
- The combined availability of IEEE 802.15.4 and Bluetooth LE connectivity enables building devices for the upcoming Matter protocol that intends to bring interoperability for Smart-Home devices. With ESP32-H2 and other SoCs in its portfolio, Espressif can offer the full spectrum of Matter solutions.

Learn More: [espressif.com](https://www.espressif.com)  
 Product Selector: [espressif.com/product-selector](https://www.espressif.com/product-selector)  
 Contact Us: [espressif.com/sales](https://www.espressif.com/sales)



# ESP 32

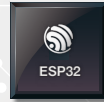

A Feature-Rich MCU with Integrated Wi-Fi and Bluetooth Connectivity for a Wide Range of Applications

## Features



### CPU & Memory

- Xtensa® 32-bit LX6 single-/dual-core processor that operates at up to 600 MIPS
- 448 KB ROM, 520 KB SRAM, 16 KB SRAM in RTC, QSPI supports multiple flash/SRAM chips



### Connectivity

- 2.4 GHz Wi-Fi 802.11 b/g/n with HT20 / HT40
- Bluetooth 4.2 (BR/EDR + LE)
- Wi-Fi and Bluetooth LE mesh support



### Peripherals

- 34 programmable GPIOs: UART, SPI, I<sup>2</sup>C, I<sup>2</sup>S, ADC, DAC, TWAI, LED PWM, touch sensor, hall sensor



### Security

- Secure boot, flash encryption, cryptographic hardware acceleration

## Applications

- Smart home
- Industrial automation
- Wearable electronics
- Retail & catering applications
- Image recognition
- Speech recognition
- Mesh network

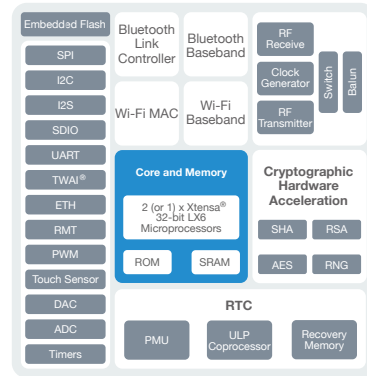

ESP32 Block Diagram

## Highlights

### High Level of Integration

- ESP32 is highly integrated with in-built antenna switches, RF balun, power amplifier, low-noise-receive amplifier, filters, and power management modules.

### Low Power

- ESP32 features all the state-of-the-art characteristics of low-power chips, including fine-grained clock gating, multiple power modes, and dynamic power scaling.

Learn More: [espressif.com](https://espressif.com)  
 Product Selector: [espressif.com/product-selector](https://espressif.com/product-selector)  
 Contact Us: [espressif.com/sales](https://espressif.com/sales)

# ESP 8266

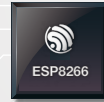

A Cost-Effective and Highly Integrated Wi-Fi MCU for IoT Applications

## Features



### CPU & Memory

- Xtensa® 32-bit L106 single-core processor that operates at up to 160 MHz
- 64 KB ROM, 160 KB SRAM, SPI/QSPI supports multiple flash/SRAM chips



### Connectivity

- 2.4 GHz Wi-Fi 802.11 b/g/n with HT20



### Peripherals

- 17 programmable GPIOs: UART, SPI, I<sup>2</sup>C, I<sup>2</sup>S, PWM, ADC, IR remote control

## Applications

- Smart home
- Industrial automation
- Smart plugs and lights
- Wearable electronics
- IP cameras
- Wi-Fi geolocation
- Wi-Fi position system beacons

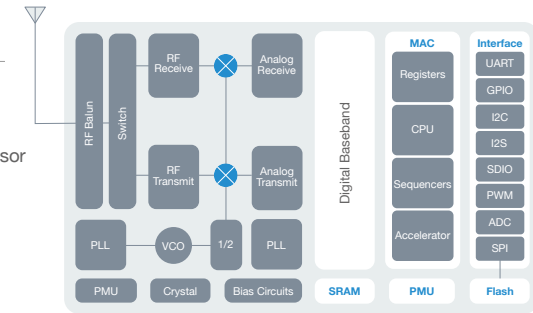

ESP8266 Block Diagram

## Highlights

### High Level of Integration

- ESP8266 integrates antenna switches, RF balun, power amplifier, low-noise receive amplifier, filters and power management modules. The compact design of ESP8266 minimizes the PCB size and requires only a few external circuitries.

### Master/Slave

- ESP8266 can perform either as a standalone SoC or as slave to a host MCU. When ESP8266 hosts the application, it promptly boots up from the flash. Also, it can be applied to any microcontroller design as a Wi-Fi adaptor through the SPI/SDIO or UART interfaces.

Learn More: [espressif.com](https://espressif.com)  
 Product Selector: [espressif.com/product-selector](https://espressif.com/product-selector)  
 Contact Us: [espressif.com/sales](https://espressif.com/sales)

# Complete AIoT Solution

## ESP RainMaker®

ESP RainMaker® provides a complete solution for building AIoT products with a minimal amount of code. It covers all Espressif chips and modules, device firmware, phone apps, voice-assistant integrations and Cloud backend. It enables customers to quickly build their own AIoT solutions based on enterprise-grade Cloud computing, with a single-click deployment.

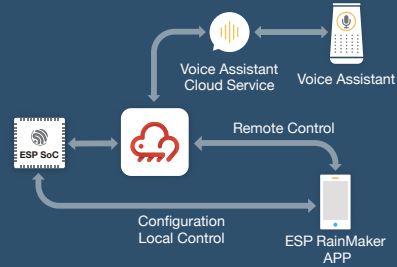

### Accelerate Your AIoT Business with Your Own Platform

- ✓ Minimize your R&D investment and business risks by using Espressif's turnkey solution.
- ✓ Focus on product innovation and differentiation with full customization.
- ✓ Ensure your business upscaling runs in a secure and stable environment.
- ✓ Gain independence by deploying your own Cloud.
- ✓ Progress quickly by shortening the development cycle.



#### Turnkey Solution

Significantly simplifies connected-device development and maintenance.



#### Pay-as-You-Grow

Pay only when your business starts to grow.



#### Independence

Own devices and user data in private Cloud.



#### Innovation

Focus on fulfilling and developing your marketing needs.

## ESP RainMaker Offer

### Device SDK & Firmware

Production-ready, open-source firmware for different product categories is available to all customers, who can then build their own products, using the ESP RainMaker device SDK.

### Voice-assistant Integrations

Ready-made support for Alexa & Google Assistant integration through smart-home skills and actions. Customers can also create their own custom skills.



### ESP SoCs & Modules

We provide customers with the most cost-effective, yet powerful, SoCs and modules that suit different product needs. ESP RainMaker works with all of Espressif's modules and SoCs.

### Device Management with Own Private Cloud

Fleet Management, OTA Upgrades, Device Diagnostics, Business Insights

### Open-Source Phone Apps

The app provides functions including User Management, Device Association, Scheduling, Device Sharing, Network Configuration, Local and Remote Control, Grouping, etc. Customers can also build their own apps.

## Third-party Service Support

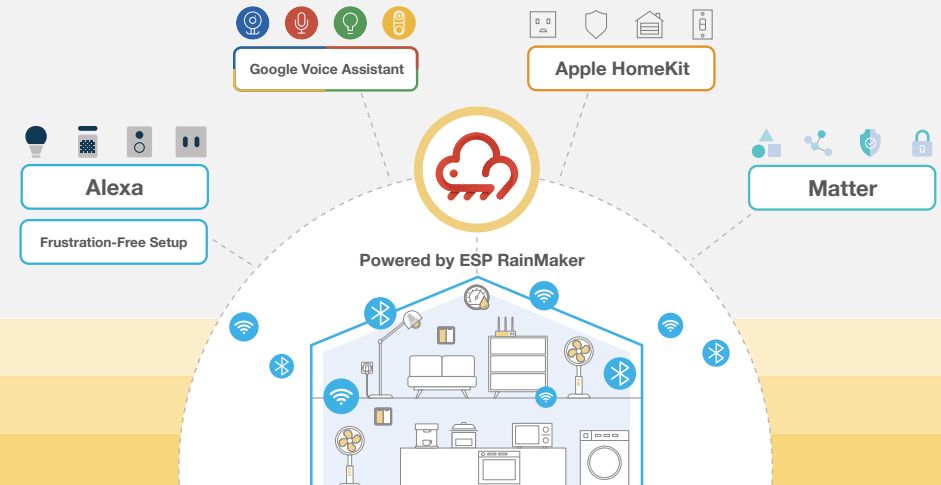

ESP RainMaker: [rainmaker.espressif.com](http://rainmaker.espressif.com)  
 Get Started: [rainmaker.espressif.com/docs/get-started.html](http://rainmaker.espressif.com/docs/get-started.html)

# Matter

## Espressif's Solution for Matter

Matter is an industry-unifying standard that provides reliable and secure connectivity for smart-home devices. Espressif has a strong commitment to supporting Matter protocol on ESP32 series SoCs. We provide the most comprehensive solutions for Matter, including support for Wi-Fi or Thread end-point devices, Thread Border Routers, and Matter gateway reference designs.

### Comprehensive Matter Solutions

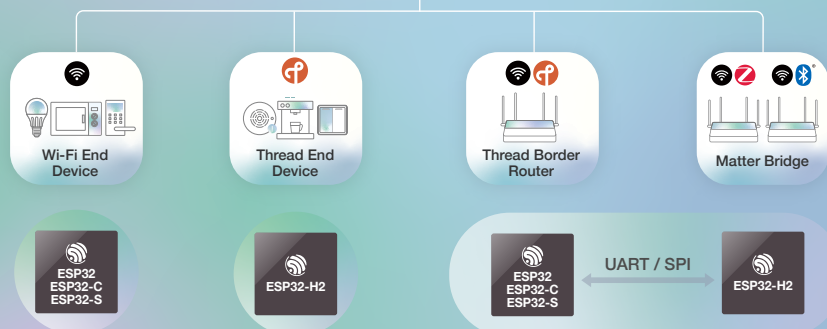

### Espressif's SDK for Matter

Espressif's SDK for Matter has been developed over the open-source Matter SDK to provide a simplified API and the required tools for building Matter-compatible devices with Espressif SoCs.

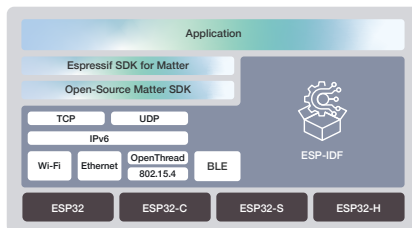

- Newly designed simplified Data Model APIs
- Tools and scripts for factory provisioning and manufacturing
- Rich device types and production-ready examples
- Integrated ESP RainMaker ecosystem
- Complete QA testing, and release process to ensure easy certifiability

Espressif's Solution for Matter: [espressif.com/solutions/device-connectivity/esp-matter-solution](https://espressif.com/solutions/device-connectivity/esp-matter-solution)

## ESP-ZeroCode Modules for Matter Connectivity

Matter protocol standard helps device manufacturers to build interoperable and secure devices that are easy to work with, communicate with each other and provide a seamless experience to end users. ESP-ZeroCode is a series of Wi-Fi and Thread (802.15.4) modules from Espressif that provide out-of-box Matter connectivity for smart home devices. With these modules, making your devices smart is as simple as just adding these modules to your devices without worrying about firmware, phone apps, and cloud connectivity development and maintenance, certification efforts, and complex manufacturing.

ESP-ZeroCode modules are built using Espressif's high-performance, secure and low-cost ESP32-C3 (ESP8685), ESP32-C2 (ESP8684) and ESP32-H2 SoCs.

### Benefits



Pre-programmed and pre-provisioned modules to simplify manufacturing and certifications



Out-of-box Matter compatibility makes them work seamlessly with Google Home, Amazon Alexa, Apple Home, and other Matter ecosystems



Device management and OTA upgrades



Optional private IoT cloud connectivity and your own Matter ecosystem with ESP RainMaker

### ESP-ZeroCode Module for Matter

These are the simplest type of modules that implement standard Matter protocol. The devices built with these modules work seamlessly with commonly used Matter ecosystems. They don't require custom phone apps or voice assistant skills. These modules come with packaged device management through a cloud dashboard and OTA.

### ESP-ZeroCode Module for Matter with RainMaker

In addition to Matter compatibility, if you wish to build products with your own branded Matter ecosystem and phone apps, these modules are well suited. With these modules, your products don't need to rely on other ecosystem hubs in the home and can be independently controlled remotely. Furthermore, your own branded phone app can work with all the Matter compatible devices.

### Supported Device Types



Light Bulbs, Panels, Downlights, LED Strips, Lamps



Switches



Sockets



Fans and Fan Controllers



Blinds/Shades Controllers

ESP-ZeroCode Modules: [espressif.com/solutions/device-connectivity/esp-matter-solution#zerocode](https://espressif.com/solutions/device-connectivity/esp-matter-solution#zerocode)

# ESP-HMI



ESP32-S3

## RGB Interface LCD

ESP32-S3 is suitable for RGB interface LCDs. ESP32-S3 supports various peripherals which can be used for building a remote control hub or smart-home panels controlling different devices, switches, scenes, temperatures, etc. ESP32-S3 has a dual-core CPU with powerful AI features, and can provide an effortless ESP32-S3 touch experience, smooth GUI response, and effective online/offline voice interaction.



**ESP32-S3-LCD-Ev-Board** supports voice recognition and near/far-field voice wake-up, while also featuring screen and voice interaction. The board is ideal for the development of touchscreen products with interfaces of different resolutions.

ESP32-C3

## SPI Interface LCD



ESP32-C3 is a cost-effective, low-power SoC that is suitable for SPI interface LCDs, such as haptic smart knobs and LCDs for small appliances. The state-of-the-art technology of ESP32-C3 allows it to dynamically adjust the operating frequency and switch over to low-power modes according to application requirements, thus improving product endurance.



### Streamlined BOM

- Diverse HMI functions based on a single cost-effective SoC
- The built-in temperature sensor provides high-temperature power-off and remote alarm functions



### Easy Development

- The solution is supported by ESP-IDF, Espressif's mature IoT development framework, with which users can easily build new applications
- Supports LVGL GUI development and the SquareLine Studio tool, which can help customers develop fancy UIs by a drag-and-drop operation without any additional knowledge of LVGL API



# ESP-MESH

## ESP-WIFI-MESH

Based on Wi-Fi communication protocols, ESP-WIFI-MESH adopts the tree topology which provides an easy-to-deploy, self-healing, and self-forming network. Based on ESP-WIFI-MESH, you can deploy a much broader network with only one router. Various points in the network can talk to each other, and also support independent access to external networks, so users can easily develop devices on their own. This solution is widely used in smart lighting, smart furniture, and automation scenarios that require multi-device network deployment and group control. Compared with Zigbee, Thread, and ESP-BLE-Mesh, ESP-WIFI-MESH can penetrate more obstacles and transfer data faster. It is a good choice if you want to independently access external networks through different points.



## ESP-BLE-MESH

A feature-rich software protocol stack created by Espressif and fully-certified by the Bluetooth Special Interest Group (SIG) in September 2019. It is open-source, and based on Zephyr ESP-BLE-MESH SDK and SIG Bluetooth Mesh Spec v1.0.



## Zigbee & Thread

Thread is an IPv6-based, low-power, wireless Mesh network. It allows end-to-end, secure, and scalable connectivity between IoT devices, mobile devices, and the Internet. Espressif's self-developed IoT Development Framework (ESP-IDF) now supports Thread and Zigbee, so users may easily develop low-power Mesh terminal devices based on Thread and Zigbee, as well as border routers, and Zigbee gateway products.

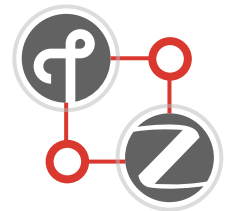

ESP-WIFI-MESH: [espressif.com/products/sdks/esp-wifi-mesh/overview](https://espressif.com/products/sdks/esp-wifi-mesh/overview)

ESP-BLE-MESH: [espressif.com/products/sdks/esp-idf/esp-ble-mesh](https://espressif.com/products/sdks/esp-idf/esp-ble-mesh)

ESP-IDF: [github.com/espressif/esp-idf](https://github.com/espressif/esp-idf)

# ESP Smart Switch (Neutral-less Solution)



# ESP-NOW

Based on ESP32-C2/ESP32-C3 SoCs, the ESP Smart Switch Solution allows customers to easily build Wi-Fi switches with low power-consumption, excellent Wi-Fi performance, security, and reliability.

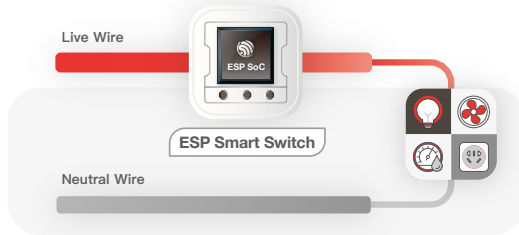

Smart Switch Circuit

## Advantages

### No Neutral Wire Required

This solution greatly reduces the installation cost of smart switches, as users do not need to install a neutral wire with the ESP Smart Switch.

### Applicable to Different Light Fixtures

The solution is applicable to almost all lights over 3 Watts, and supports up to 2,000-Watt incandescent lights and 500-Watt LED lights in one-way circuits.

### Matter and ESP RainMaker

ESP32-C2 and ESP32-C3 support Matter and ESP RainMaker. Customers can control devices remotely over mobile apps without gateway.

### Ultra-Low Power, No Anti-Flicker Required

When connected to Wi-Fi, the switch current is between 600 and 800 uA, which ensures lights work fine without any anti-flicker modules.

### Excellent Wi-Fi Performance

ESP32-C2 and ESP32-C3 feature industry-leading RF performance with Wi-Fi RF receiver (RX) sensitivity up to -98.4 dBm and Wi-Fi RF transmitter (TX) power up to 21 dBm.

### Secure and Reliable

The security feature of ESP32-C2 and ESP32-C3 protects connected IoT devices from malware attacks that may pose a threat to data security.

## Services

Espressif enables customers to quickly develop and implement Wi-Fi smart switch products from scratch, without the need of installing a neutral wire along the way.



SoCs and modules



Hardware design



Software solutions



Firmware development  
and maintenance



Device power  
consumption optimization



Mobile app

ESP-NOW is a wireless communication protocol based on the data-link layer defined by Espressif. It reduces the five layers of the OSI model to only one. In other words, the data need not be transmitted through the network layer, the transport layer, the session layer, the presentation layer, and the application layer. Also, there is no need for packet headers or unpackers on each layer, which leads to a quick response reducing the delay caused by packet loss in congested networks.



Coexists with Wi-Fi and Bluetooth LE, and supports various series of Espressif SoCs



It is suitable for connecting and controlling “one-to-many” and “many-to-many” devices



Occupies fewer CPU and flash resources



Can be used as an independent, auxiliary protocol that helps with device provisioning, debugging, and firmware upgrades



ECDH and AES algorithms make data transmission more secure



The window synchronization mechanism greatly reduces power consumption

ESP32-C2

## ESP-NOW Switch

We provide a low-power Wi-Fi switch solution based on ESP32-C2. It is different from Bluetooth LE and Zigbee wireless switches, because this solution needs no gateway and can be used with the ESP-NOW protocol, which enables quicker responses. The Wi-Fi switch has a long battery life and can be built into different forms of products, thanks to the tiny size of the cell.



### Tiny and Ultra-Low Power Consumption

- The chip is powered off in the sleep mode. One CR2032 coin battery can last up to 5 years (if the switch is flipped approximately 10 times a day)



### Quicker Controllable Response

- After you flip the switch, the device will respond within 150 ms
- With a transmit power of up to 21 dBm, devices 200 meters away in open space become controllable



### Diversified Product Forms

- Supports forms such as sticker switches, multi-button switches, touch switches, and knob switches

ESP-NOW: [espressif.com/en/news/ESP-NOW](https://espressif.com/en/news/ESP-NOW)

# ESP Insights



# Audio Solutions

ESP Insights is a device observability framework that allows developers to remotely peek into their firmware, and get information about the firmware execution. This information can then be used for analysing any issues and getting a deeper understanding of any problematic areas. Such a data-collecting observation should help organisations save valuable engineering resources, allowing them to speed up firmware development and fix any issues within a short time.

## ESP Insights



## Features

- Observing **critical logs and errors** that the firmware has generated during its execution.
- In case of a **firmware crash**, users can observe **the register dump and the backtrace**, in order to understand the root cause of the failure.
- Examining the **device timeline** to find out events of interest and their sequence.
- Adding **custom events** to the timeline.
- Observing **firmware metrics** that consist of common system parameters such as free heap, largest free memory block etc.
- Defining and viewing certain **variables of interest**.



ESP Insights: [github.com/espressif/esp-insights](https://github.com/espressif/esp-insights)

## ESP Audio Front-End Algorithms

Espressif has created a set of audio front-end (AFE) algorithms that result in a solid voice-controlled performance even in noisy environments. Customers can use these algorithms with Espressif's powerful ESP32 and ESP32-S3 SoCs, in order to build high-performance, yet low-cost, products with a voice-user interface. Espressif's AFE algorithms have been **qualified by Amazon** as a "Audio Front End" solution for Alexa built-in devices.

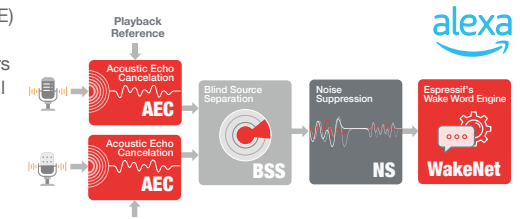

- Outstanding Acoustic Performance:** The algorithms have been qualified by Amazon in Alexa far-field tests. Our own wake-up engine WakeNet can meet Amazon's test requirements for multi-languages.
- Low-Resource Consumption:** The algorithms consume around 22% of CPU, 48 KB SRAM and 1.1 MB PSRAM.
- Flexibility:** Offering an easy and intuitive API. The distance between the two microphones can be between 20-80 mm.

## ESP-Skainet

Espressif's offline smart-voice assistant currently supports a configurable wake-word engine (WakeNet), and an offline speech-recognition engine (MultiNet) with up to 200+ offline commands and acoustic algorithms.

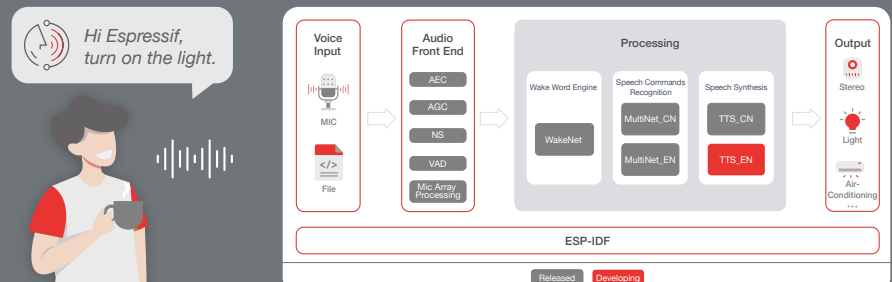

ESP AFE: [espressif.com/solutions/audio-solutions/esp-afe](https://espressif.com/solutions/audio-solutions/esp-afe)

ESP-Skainet: [espressif.com/solutions/audio-solutions/esp-skainet/overview](https://espressif.com/solutions/audio-solutions/esp-skainet/overview)



## ESP32-S3-BOX AI Voice Development Kit

ESP32-S3-BOX provides a platform for developing the control of smart devices with offline and online voice assistants. It is ideal for developing AIoT applications with reconfigurable AI voice functions, such as smart speakers, and IoT devices that achieve human-computer voice interaction directly.



Voice Assistant



Touch Screen Control



Sensor



Infrared Remote Control



Smart Gateway



ESP32-S3-BOX combines a touch screen controller, various sensors, an infrared controller and a smart gateway. With all this functionality and its product-ready form factor, ESP32-S3-BOX will help you save significant R&D expenses, and shorten the development cycle of your product.

### Highlights

- Online and Offline Voice Assistant:** ESP32-S3-BOX is equipped with Espressif's AI Voice Recognition system, with which you can customize the command phrases for giving instructions.
- HMI Touch Screen:** 320 x 240 capacitive touch screen, Integrated LVGL in SDK
- Smart Gateways:** Thread Border Router, Zigbee gateway, Wi-Fi/Bluetooth gateway, Wi-Fi hotspot
- Extensible Pmod™ Interface:** Providing two Pmod™-compatible headers (with 16 programmable GPIOs) that support interfacing with various peripherals for flexibly expanding the functions of the board.

ESP32-S3-BOX: [github.com/espressif/esp-box](https://github.com/espressif/esp-box)

## ESP-AVS

Espressif provides a solution to develop devices with built-in Alexa Voice Services (AVS). The ESP32-WROVER-E series of modules, in combination with an external DSP, provides the industry's most cost-effective, yet feature-rich, solution. The availability of the device and its companion phone app SDKs reduce development efforts significantly.

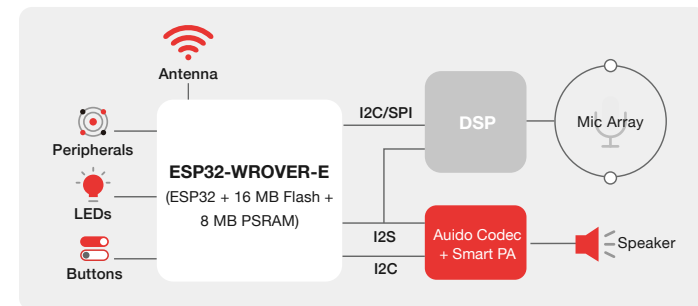

Hardware Architecture

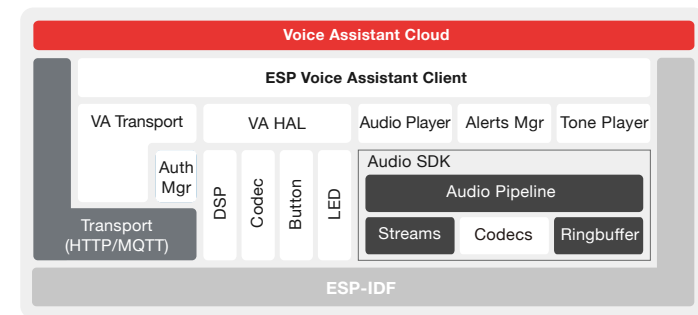

SDK Architecture



**Hardware:** The ESP32-Vaquita series of boards provides a reference design for built-in Voice Assistant connected devices, along with schematics, layout and BOM.



**SDK:** Espressif's VA SDK provides production-ready example applications that include full AVS functionality, including music service support.

ESP AVS: [espressif.com/solutions/audio-solutions/esp-avs](https://espressif.com/solutions/audio-solutions/esp-avs)



# Face Recognition



## ESP-WHO

ESP-WHO is a face detection and recognition development framework based on ESP32 and ESP32-S3. You can use it with the **ESP-EYE**, **ESP32-S3-EYE** or the **ESP-WROVER-KIT** development board. Then, by adding only a few peripherals, such as cameras and screens, you can easily create complete AIoT applications.

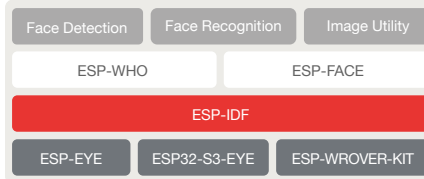

**Security**  
Local memory



**Cost-Effectiveness**



**High Performance**  
10 frames per second



**Expandability**

- Object detection
- Object tracking
- Hand-gesture recognition

## ESP-EYE

**ESP32-S3-EYE** is based on the ESP32-S3 SoC. It features a 2-Megapixel camera, an LCD display, and a microphone, which are used for image recognition and audio processing. ESP32-S3-EYE offers plenty of storage, with an 8 MB Octal PSRAM and a 8 MB flash.

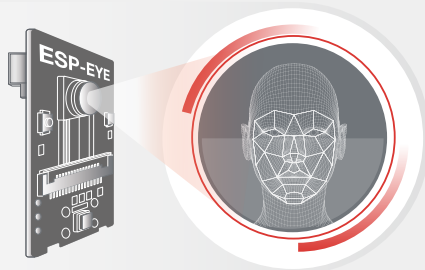

**ESP-EYE** is an ESP32-based development board that integrates a digital microphone, an 8 MB PSRAM and a 4 MB flash, while also providing an external 2-Megapixel camera. These features make the board ideal for applications relating to face detection, face recognition and speech recognition. Besides, the board can also support image transmission over Wi-Fi and debugging through a Micro USB port, which enables the development of advanced AI solutions.



ESP-EYE is an AWS-qualified development board. In addition to Espressif's own ESP-IDF SDK, you can use FreeRTOS on ESP-EYE. This development board can also be used with FreeRTOS for simple camera and audio capture use-cases. It provides out-of-the-box connectivity with AWS-IoT and other AWS services.

ESP-WHO: [espressif.com/products/devkits/esp-eye/overview](https://espressif.com/products/devkits/esp-eye/overview)

ESP-EYE: [github.com/espressif/esp-who/blob/master/docs/en/get-started/ESP-EYE\\_Getting\\_Started\\_Guide.md](https://github.com/espressif/esp-who/blob/master/docs/en/get-started/ESP-EYE_Getting_Started_Guide.md)

ESP32-S3-EYE: [github.com/espressif/esp-who/blob/master/docs/en/get-started/ESP32-S3-EYE\\_Getting\\_Started\\_Guide.md](https://github.com/espressif/esp-who/blob/master/docs/en/get-started/ESP32-S3-EYE_Getting_Started_Guide.md)



# Device Connectivity



## ACK Solution

Why worry about writing an Alexa skill, or managing Cloud services, phone applications and complex device firmware? Espressif offers an easy way for customers to build Alexa-connected devices with Espressif's Alexa Connect Kit (ACK) hardware and software. Espressif's **ACK SDK** and **ACK module** provide solid and secure Alexa connectivity, while also supporting features like Frustration-Free Setup and Amazon Dash Replenishment. ACK SDK can run on Espressif's ESP32-C3-based modules to provide a single-chip ACK solution, whereas ESP32-PICO-V3- ZERO is Espressif's ACK module that provides seamless Alexa connectivity to host MCUs.

### ACK SDK



ACK SDK is a software package from Amazon that enables ODMs and system integrators to build their own ACK-based modules and Alexa-compatible, smart-device solutions. Espressif makes ACK SDK available on Espressif's secure and cost-effective **ESP32-C3** SoC (ESP32-C3FH4AZ and ESP8685H4 variants), which is qualified by Amazon to run ACK SDK.

Customers can use ACK SDK with ESP32-C3, in order to take advantage of ACK-managed cloud services, along with such features as Alexa control, Frustration-Free Setup, security, log and metrics collection, and firmware updates. ACK SDK is available in source format, which offers full customization, while keeping the application development simple. Since both ACK SDK and the application run on the same MCU, it is now easier than ever to build low-cost, single-chip, Alexa-compatible devices.

### Espressif's ACK SDK-Related Design Services



Hardware Design



RF Design



Application Development



Module Certification



Module Provisioning

### ACK Module

**ESP32-PICO-V3-ZERO**, the Alexa Connect Kit (ACK) module with an Espressif chipset, and its related development kit **ESP32-PICO-V3-ZERO-DevKit**, provide an easy way for customers to build Alexa-connected devices without worrying about writing an Alexa Skill and managing Cloud services, phone applications or complex device firmware. Espressif's ACK Solution provides Alexa connectivity and support features, such as Frustration-Free Setup and Amazon Dash Replenishment.

ESP32-PICO-V3-ZERO comes pre-programmed with the ACK module firmware. It is also pre-provisioned with credentials for connecting to an ACK-managed Cloud service. The ACK module firmware is managed by Amazon and provides out-of-box features, such as Frustration-Free Setup, Alexa connectivity and Amazon Dash Replenishment.



ACK Solution: [espressif.com/solutions/device-connectivity/ack-solution](https://espressif.com/solutions/device-connectivity/ack-solution)



## ACS Solution

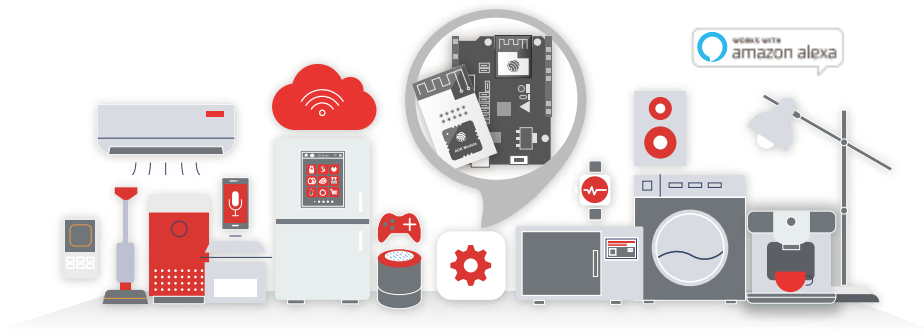

Amazon Common Software (ACS) for Devices is Amazon's optimized software that simplifies the integration of various Amazon Device SDKs in your connected products. Espressif's ESP32 SoC is a qualified platform for ACS, supporting it with a stable and production-ready Device Porting Kit (DPK). With the ESP32 DPK, developers can implement the required API for accessing device hardware, as well as for operating system APIs and connectivity features. Combining the ESP32 DPK implementation with the ACS middleware and the Amazon Device SDKs provides a well-maintained and well-tested development platform for your application.

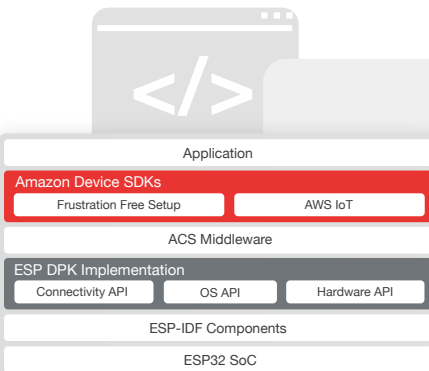

Espressif provides a comprehensive software package that includes a Frustration-Free Setup Device SDK, ACS middleware, Espressif's DPK implementation, and an example application.

**ESP32-Vaquita-DSPG** is a development board that can be used as a hardware platform for running the Alexa built-in application based on this software.

ACS Solution: [espressif.com/solutions/device-connectivity/acs-solution](https://espressif.com/solutions/device-connectivity/acs-solution)



## ESP AWS IoT ExpressLink Solution

**Espressif's AWS IoT ExpressLink module** (ESP32-C3-MINI-1-N4-A) is based on the ESP32-C3 Wi-Fi + Bluetooth 5 (LE) SoC, which provides host MCUs with out-of-the-box, seamless, AWS IoT connectivity, while also implementing the AWS IoT ExpressLink specification.

ESP32-C3-MINI-1-N4-A has a simple serial interface through which the host MCU gets connected to AWS IoT services, thus transforming any offline product into a Cloud-connected product. Espressif's AWS IoT ExpressLink Module handles complex, yet undifferentiated, workload, such as authentication, device management, connectivity, messaging and OTA. Thus, it relieves developers from developing and maintaining complex firmware, while it provides end-to-end security and fleet management at scale.

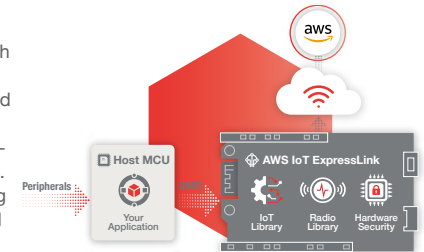

### Software Features

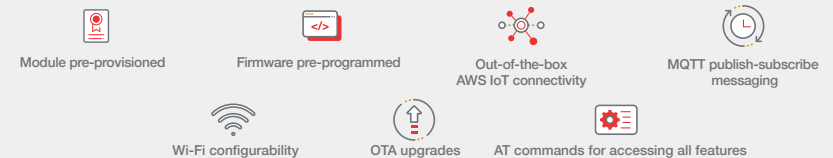

### Hardware Features



### ESP32-C3-AWS-ExpressLink-DevKit

The ESP32-C3-AWS-ExpressLink-DevKit is a development board that hosts Espressif's AWS IoT ExpressLink module. It can be used with an external host MCU for easy evaluation and prototyping. The pin layout of ESP32-C3-AWS-ExpressLink-DevKit is compatible with that of the Arduino Zero development board and, therefore, it can be directly plugged into the Arduino Zero board, or be easily connected to other host MCUs, such as the Raspberry Pi.



ESP AWS IoT ExpressLink: [espressif.com/solutions/device-connectivity/esp-aws-iot-expresslink](https://espressif.com/solutions/device-connectivity/esp-aws-iot-expresslink)  
 AWS IoT ExpressLink: [aws.amazon.com/iot-expresslink](https://aws.amazon.com/iot-expresslink)



# Espressif's Customer Support

Espressif supports customers, all the way from design to certification and manufacturing.

## Open-Source Documentation



- Datasheets, technical reference manuals, user guides, API references, and test reports are accessible for free.
- Official forums where user requests and questions are answered by Espressif engineers.

## Open-Source Software



- ESP-IDF, ESP-ADF, ESP-MDF, ESP-WHO and ESP-Skainet development frameworks are accessible for free.
- ESP-IoT-Solution, which contains device drivers and code frameworks for IoT development, is available to anyone.

## RF Design Review and Assistance



- PCBA proofing, RF designing, RF matching, debugging, and RF testing are provided to our customers.



## Hardware Resources and Reviewing Services

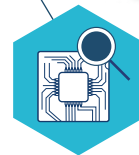

- Reference designs and hardware design guidelines
- Free-of-charge schematic and PCB reviewing
- Response in 1-3 working days

## Manufacturing



- Pre-provisioned modules with device certificates
- Customized services such as flash programming, MAC address, etc.

## On-Site Support



- To facilitate the project development in a highly efficient way, Espressif's most qualified engineer will provide onsite support upon customers' request.

**By choosing our products and services, you get to concentrate on your design, and bring your product to life quickly, efficiently and securely.**

 **Contact us:** [espressif.com/sales](mailto:espressif.com/sales)





## Disclaimer and Copyright Notice

- Information in this brochure, including URL references, is subject to change without notice.
- All third-party information in this brochure is provided as is with no warranty to its authenticity and accuracy.
- No warranty is provided for this brochure about its merchantability, non-infringement of any proprietary rights, fitness for any particular purpose, nor does any warranty otherwise arise out of any proposal, specification or sample.
- All liability, including liability for infringement of any proprietary rights, relating to use of information in this brochure is disclaimed. No licenses express or implied, by estoppel or otherwise, to any intellectual property rights are granted herein.
- The Wi-Fi Alliance Member logo is a trademark of the Wi-Fi Alliance. The Bluetooth logo is a registered trademark of Bluetooth SIG.
- All trade names, trademarks and registered trademarks mentioned in this document are property of their respective owners, and are hereby acknowledged.

## X-ON Electronics

Largest Supplier of Electrical and Electronic Components

*Click to view similar products for [Audio IC Development Tools](#) category:*

*Click to view products by [Espressif](#) manufacturer:*

Other Similar products are found below :

[1580/5171-DEMO](#) [EV\\_ICS-40740-FX](#) [QC-ACC-AUDIO-OUT](#) [QC-ACC-AUDIO-IN](#) [PAM8965-EVM](#) [1063](#) [TAS5756MDCAEVM](#)  
[TLV320ADC3101EVM-K](#) [TLV320AIC3007EVM-K](#) [TLV320AIC3105EVM-K](#) [TLV320AIC3111EVM-K](#) [TLV320AIC3253EVM-K](#)  
[TLV320DAC32EVM-PDK](#) [TPA2035D1EVM](#) [TPA2051D3YFFEVM](#) [TPA3107D2EVM](#) [TPA6120A2EVM](#) [TPA6132A2EVM2](#) [MIKROE-](#)  
[2454](#) [ISD5102EY](#) [1381](#) [DA7217-EVAL](#) [DIX4192EVM-PDK](#) [LM48555TLBD](#) [LM4962TLBD/NOPB](#) [LME49710HABD](#) [1712](#) [175](#) [1788](#)  
[SSM2167Z-EVAL](#) [TAS5412Q1PHDEVM](#) [TAS5414CQ1PHDEVM](#) [TAS5754MDCAEVM](#) [TS3A226AEEVM](#) [PGA2505EVM](#) [CRD4525-Q1](#)  
[CRD48L10-4IN4OUT](#) [CRD44600-PH-FB](#) [CRD48L11](#) [AC102014](#) [CDB8422](#) [CDB8420](#) [CDB53L21](#) [CDB5381](#) [CDB5346](#) [CDB470XS-](#)  
[DC28](#) [CDB470XD-DC48](#) [CDB4352](#) [CDB4344](#) [CDB4270](#)