



ESSENTRA

COMPONENTS

essentracomponents.com

© 2013 Essentra Components. All rights reserved.
 Registered in England, Company No. 547495.
 Registered Office: Avebury House,
 201-249 Avebury Boulevard, Milton Keynes, MK9 1AU

Condition of Sale can be found on our website:
 essentra.com.

Essentra Components does not warrant that the files will be error free and may create new versions ("Upgrades") at any time, which may correct such errors. Essentra Components has no obligation to notify you of such upgrades. Any upgraded file will be published to the website, when it becomes available.

You are not permitted to load any of the files on to a network server for the purposes of distribution to one or more other computer(s) on that network or to effect such distribution. Essentra Components shall not be liable for any loss or damage whatsoever or however caused, arising directly or indirectly from the use of the files.

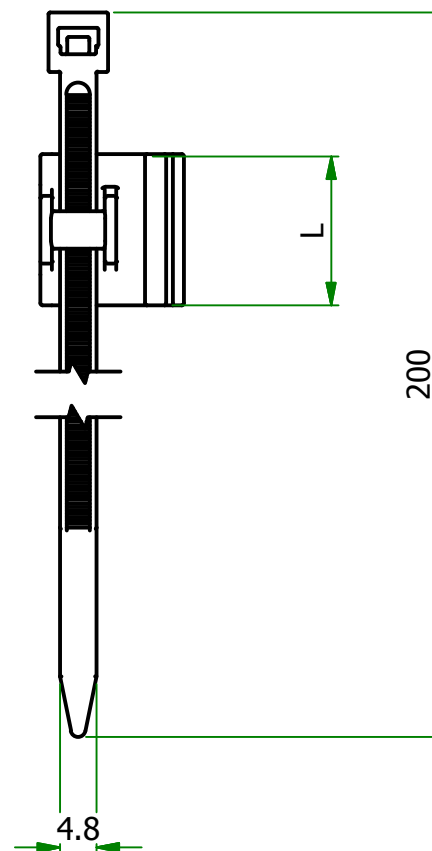
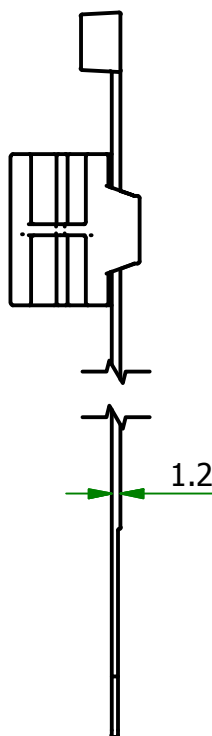
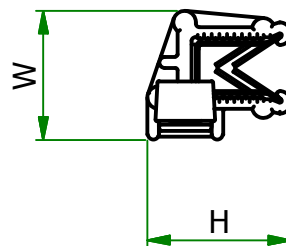
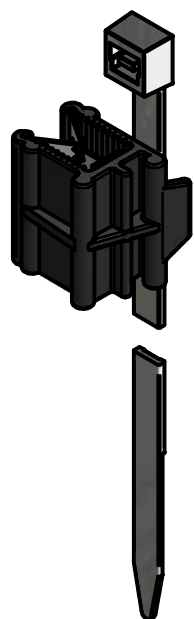

UNCONTROLLED

UNLESS OTHERWISE STATED

ALL DIMENSIONS IN mm				DO NOT SCALE	
LINEAR TOLERANCE				THIRD ANGLE PROJECTION	
SIZE	(0)	(0.0)	(0.00)		
0-10mm	±0.5	±0.15	±0.10		
10-30mm	±0.5	±0.20	±0.15		
30-50mm	±0.5	±0.30	±0.20		
50-100mm	±0.8	±0.50	±0.25		
100-200mm	±1.5	±0.80	±0.40		
200-300mm	±2.0	±1.20	±0.80	ANGULAR TOLERANCE ±0.5 DEGREES	
300-500mm	±3.0	±2.00	±1.00	UNSPECIFIED RADII 0.25mm	
+500mm	±5.0	±3.00	±1.50	DRAFT ANGLE 0.5 DEGREES	

ORG.SCALE 1:1

MATERIAL POLYAMIDE AND ST STEEL

ITEM No. 550250

TITLE METAL EDGE CABLE TIE MOUNTING CLIPS

DWG.No. SR6261-4 ISSUE No. 1

Item	Panel Thickness (mm)	W	L	H	Cable Tie Size
550250	3.0 - 6.0	17.1	20	18.8	--

X-ON Electronics

Largest Supplier of Electrical and Electronic Components

Click to view similar products for [Cable Tie Mounts](#) category:

Click to view products by [ESSENTRA](#) manufacturer:

Other Similar products are found below :

[3-350087-0](#) [CTB75X75BKA-C](#) [561-EZAB580T](#) [561-EZS375B40](#) [561-TA250125](#) [08443-0](#) [10035-0](#) [561-TA00600](#) [1689174-1](#) [08445-0](#)
[10351-0](#) [561-TA250125B](#) [20015-0](#) [10350-0](#) [10029-0](#) [08484-0](#) [08446-0](#) [08318-0](#) [PAM075NY-A-C](#) [MTH1-3](#) [10044](#) [151-11319](#) [151-11819](#)
[PLWP1SB-D](#) [PLWP1M-C](#) [PLWP2SA-D](#) [PLWP2SB-D](#) [PLWP2S-C](#) [PLWP1S-D](#) [PLWP1M-D](#) [TA1S8-C](#) [ABM3H-A-L](#) [ABM3H-AT-T0](#)
[EMS-A-C0](#) [EMSK3-1-3-0](#) [10079](#) [10030](#) [151-10930](#) [151-10920](#) [3590](#) [151-28320](#) [151-28349](#) [151-28530](#) [151-10914](#) [151-10904](#) [151-10916](#)
[151-10906](#) [06297](#) [CTB75X75NTA-C](#) [792](#)