

FIG 1: FINGER GUARD

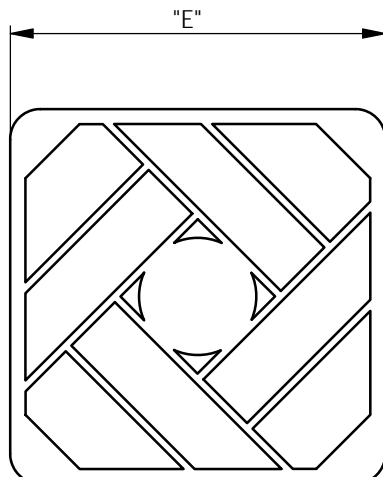

FIG 1: FILTER COVER

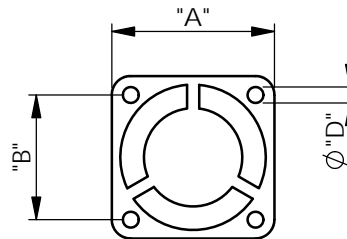
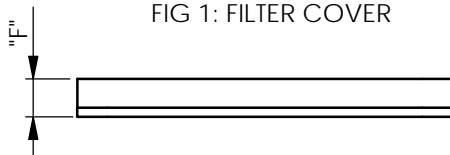

FIG 2: FINGER GUARD

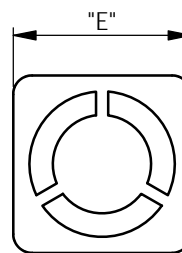
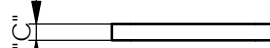
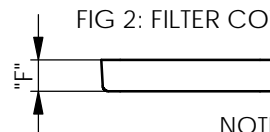
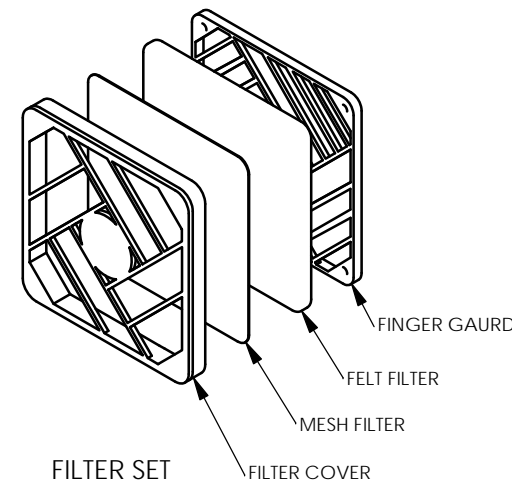

FIG 2: FILTER COVER



REV.	MODIFICATION.	DATE	DRN
01	DRAWING RELEASE	29/09/09	OW
02	CO 2010840	14/10/09	TC
03	CO2011190	31/08/11	SF
04	CO2011224	04/01/12	SF



NOTES:  
 FINGER GUARD MATERIAL: NYLON 6/6 25% GLASS FILLED UL94 V-0 (RMS-027)  
 FILTER COVER MATERIAL: NYLON 6/6 25% GLASS FILLED UL94 V-0 (RMS-027)  
 FELT FILTER MATERIAL: 100% POLYESTER FIBRE (RMS-028)  
 MESH FILTER MATERIAL: STAINLESS STEEL AISI 304 (RMS-029)  
 ALTERNATE UNITS FOR REFERENCE ONLY  
 FIG 1 MESH DIAGONAL CONFIGURATION SHOWN FOR ILLUSTRATION PURPOSE ONLY AND VARIES DEPENDING ON ACTUAL SIZE SUPPLIED

ITEMS	SIZES				
	40 X 40	60 X 60	80 X 80	92 X 92	120 X 120
FINGER GUARD, FILTER COVER, MESH FILTER AND FELT FILTER	RCP-040-T	RCP-060-T	RCP-080-T	RCP-092-T	RCP-120-T
MESH FILTER	RMF-040-T	RMF-060-T	RMF-060-T	RMF-092-T	RMF-120-T
FINGER GUARD ONLY	RFG-040-T	RFG-060-T	RFG-080-T	RFG-092-T	RFG-120-T
FELT FILTER	RFF-040-T	RFF-060-T	RFF-080-T	RFF-092-T	RFF-120-T

FILTER SETS		FINGER GUARD					FILTER COVERS NOT SUPPLIED SEPERATELY PART No. FOR REFERENCE ONLY			
PART No.	FIG	FINGER GAURD PART No.	DIM "A" +/- 0.5 [0.2]	DIM "B" +/- 0.3 [0.1]	DIM "C" +/- 0.3 [0.1]	HOLE DIM "D" Min	FILTER COVER PART No.	FIG	DIM "E" +/- 0.5 [0.2]	DIM "F" +/- 0.3 [0.1]
RCP-040-T	2	RFG-040-T	43 [1.69]	32.2 [1.27]	4.3 [0.17]	4.1 [0.16]	RFC-040-T	2	46.5 [1.83]	8.4 [0.33]
RCP-060-T	1	RFG-060-T	60.5 [2.38]	50.1 [1.97]	6.0 [0.24]		RFC-060-T	1	64.9 [2.56]	12.5 [0.49]
RCP-080-T		RFG-080-T	80.6 [3.17]	71.8 [2.83]			RFC-080-T		84.8 [3.34]	
RCP-092-T		RFG-092-T	92.3 [3.63]	82.4 [3.24]			RFC-092-T		96.9 [3.81]	
RCP-120-T		RFG-120-T	120.6 [4.75]	105.5 [4.15]			6.2 [0.24]		RFC-120-T	

INFORMATION CONTAINED IN THIS DOCUMENT IS CONFIDENTIAL TO RICHCO INTERNATIONAL Co. Ltd. AND MAY NOT BE DISCLOSED OR REPRODUCED IN WHOLE OR PART WITHOUT THEIR WRITTEN CONSENT.

**RICHCO, INC.**  
 WWW.RICHCO-INC.COM

ALL DIMENSIONS IN mm  
 GENERAL TOLERANCES ±0.25  
 UNLESS OTHERWISE STATED  
 ANGULAR ±1°

THIRD ANGLE

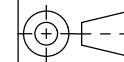

MATERIAL:  
 SEE NOTES

COLOUR:  
 BLACK

DESCRIPTION:  
 FAN FILTER ASSEMBLY

PART No:  
 SEE TABLE

DRG No:  
 09-107

NPR No:  
 EU09-0054

SHEET SIZE  
 A4

DRN  
 L.P

DATE  
 2/9/09

CHKD  
 TC

DATE  
 14.10.09

SCALE  
 NTS

SHEET No.  
 1 OF 1

## X-ON Electronics

Largest Supplier of Electrical and Electronic Components

*Click to view similar products for [Fan Accessories](#) category:*

*Click to view products by [Essentra](#) manufacturer:*

Other Similar products are found below :

[LZ31](#) [63070-2-4013](#) [64442-1-7612](#) [95778-1-5171](#) [99485901](#) [27453.32262](#) [95779-1-5171](#) [9614-2-4013](#) [99485906](#) [F92-B](#) [FG92-W2](#) [2170-4-7320](#) [27453.32298](#) [R88ACPU001M1](#) [R88ACPU001M2](#) [31570-2-4013](#) [LZ22-2](#) [LZ24-1](#) [LZ30-9](#) [LZ37-2](#) [450-20-0025](#) [525-00-0009](#) [450-20-0017](#) [450-20-0020](#) [04.846.1353.0](#) [04.846.1453.0](#) [055032](#) [08121](#) [08188](#) [08124](#) [08196](#) [54476-2-4013](#) [71883-2-4053](#) [63071-2-4013](#) [52544-2-4037](#) [64445-1-7612](#) [66786-4-7320](#) [88601-2-2929](#) [08164](#) [4013-2-4039](#) [R88A-CTW001N](#) [73772-2-3634](#) [73802-2-3634](#) [73805-2-3634](#) [73810-2-3634](#) [73814-2-3634](#) [R88A-CAGC010S](#) [9-8444-PFE](#) [01505-4-6711](#) [9415-2-4039](#)