

SWITCH FUNCTION		
POS. 1	POS. 2	POS. 3
ON	OFF	(ON)
2-3	OPEN	2-1

(ON) = MOMENTARY

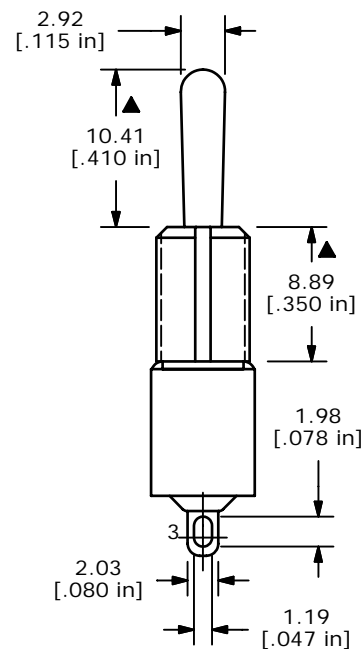
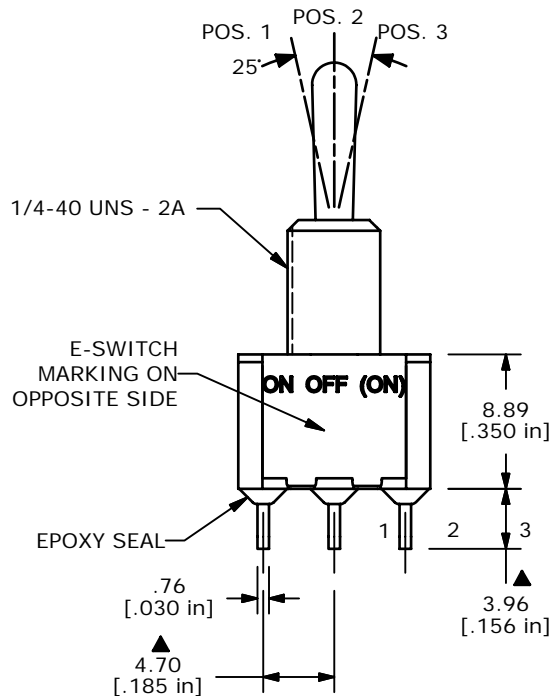
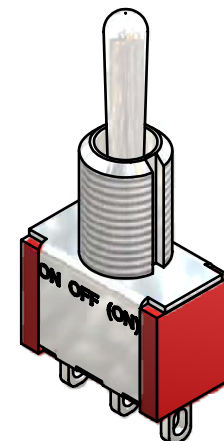
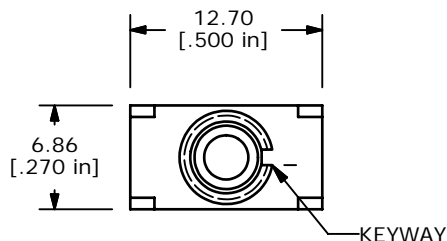
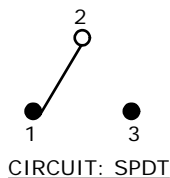

NOTE:

1. ALL DIMENSIONS IN MM [INCH]
2. GENERAL TOLERANCE: X.X=±0.4
X.XX=±0.25
3. TERMINAL NUMBERS FOR REF ONLY
- ▲4. CONTACT MATERIAL: SILVER
5. RATING: 2A @ 250 VAC
5A @ 120 VAC OR 28 VDC
6. ELECTRIC LIFE: 40,000 MAKE-AND-BREAK CYCLES AT FULL LOAD.
7. INSULATION RESISTANCE: 1,000 MEGA-OHM MIN.
8. DIELECTRIC STRENGTH: 1,000 V RMS @SEA LEVEL.
9. OPERATING TEMP.: -30°C to 85°C
10. ▲ DENOTES CRITICAL PARAMETER.
11. 2002/95/EC (ROHS) COMPLIANT
12. HARDWARE TO BE SHIPPED BULK:
T100011 - LOCK WASHER (1)
T100015 - LOCK RING (1)
T100000 - HEX NUT (2)

E-SWITCH®

TITLE 100SP5T1B1M1QE H

A	16393	RELEASED FOR PRODUCTION	8/31/06	BO
REV	PCR NO	DESCRIPTION	DATE	BY

THE INFORMATION CONTAINED IN THIS DOCUMENT IS PROPRIETARY TO E-SWITCH AND IS NOT TO BE COPIED OR TRANSFERRED

SCALE	DATE	DR	DWG	REV
2:1	8/31/2006	BO	ST115005	A

X-ON Electronics

Largest Supplier of Electrical and Electronic Components

Click to view similar products for [Toggle Switches](#) category:

Click to view products by [E-Switch](#) manufacturer:

Other Similar products are found below :

[8928K478](#) [020017-13](#) [60012L](#) [6006L](#) [CS115W](#) [CS120W](#) [637H/25](#) [6663](#) [7101SPDV30BE](#) [7103SDV30BE](#) [7105D](#) [7108P3YAV2BE](#)
[71YY50282](#) [7300K36](#) [7301K38](#) [7306K36](#) [7310K36](#) [7506K4](#) [7592K6](#) [7660K12](#) [7691K14](#) [7700K1](#) [8396K108](#) [8824K14](#) [8828K13](#) [8835K3](#)
[8858K44](#) [PS83-121G](#) [1-1825192-0](#) [A201SCWZB04](#) [A207SYCB04](#) [A208J61ZQ0004](#) [A221T1TCQ](#) [A232M1YCQ](#) [A323S1CWZQ](#)
[A423S1CWZG-M8](#) [1201W](#) [12156AX408](#) [12147AGKX679](#) [12246X778](#) [12TW49-3D](#) [130312](#) [13037L](#) [13001X](#) [AE101MD1W4B04](#)
[AE208SD1W4B04](#) [MS24659-22D](#) [MS27407-5](#) [1520230-9](#) [1520231-1](#)