

# 400U SERIES ROCKER SWITCH

- ANTI-VANDAL SWITCHES
- DETECTOR SWITCHES
- DIP SWITCHES
- KEYLOCK SWITCHES
- NAVIGATION SWITCHES
- PUSHBUTTON SWITCHES
- ROCKER SWITCHES**
- ROTARY SWITCHES
- SLIDE SWITCHES
- SNAP ACTION SWITCHES
- TACTILE SWITCHES
- TOGGLE SWITCHES
- CAP OPTIONS

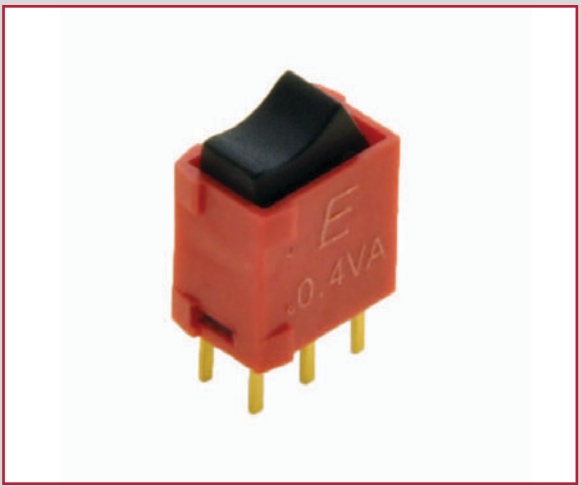

## APPLICATIONS / MARKETS

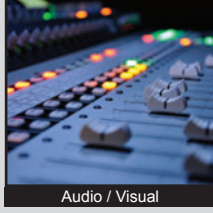

Audio / Visual



Consumer Electronics



Vending Machines



Kiosks



Instrumentation



Medical Equipment

# RoHS

## SPECIFICATIONS

**Electrical Rating:** 0.4VA @ 20V Max (AC or DC)  
**Life Cycles:** 50,000 Cycles  
**Contact Resistance:** 100mΩ initial  
**Insulation Resistance:** 500 MΩ Min. @ 500VDC  
**Dielectric Strength:** 500VAC  
**Operating/Storage Temperature:** -30°C to 85°C

## FEATURES & BENEFITS

- Ultra-miniature in size
- Lever or rocker actuator options
- Multiple termination options
- Multiple actuator colors
- Double pole

## PART NUMBER CONFIGURATOR

Series	Circuit	Function	Actuator	Actuator Color	Terminal	Contact Material	Seal
<input type="text" value="4"/> <input type="text" value="0"/> <input type="text" value="0"/> <input type="text" value="U"/>	<input type="text" value="D"/> <input type="text" value="P"/>	<input type="text" value="1"/>	<input type="text" value="R"/> <input type="text" value="1"/>	<input type="text" value="B"/> <input type="text" value="L"/> <input type="text" value="K"/>	<input type="text" value="M"/> <input type="text" value="2"/>	<input type="text" value="R"/>	<input type="text" value="E"/>
400U	DP - Double Pole	1 - ON-NONE-ON	R1 - Rocker L1 - Lever	BLK - Black RED - Red WHT - White	M2 - PC thru-hole M6 - Right Angle, PC thru-hole M7 - Vertical right angle, PC thru-hole	R - Gold	E - Epoxy

*Specifications subject to change without notice*



**E-SWITCH®**

www.e-switch.com

800.867.2717

# 400U SERIES ROCKER SWITCH

## M2 TERMINATION

### Rocker Actuator

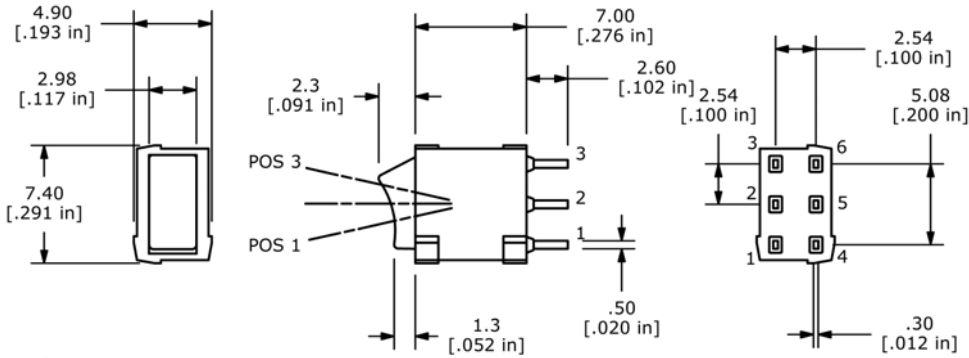

### Lever Actuator

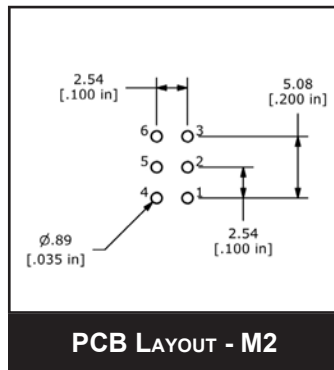
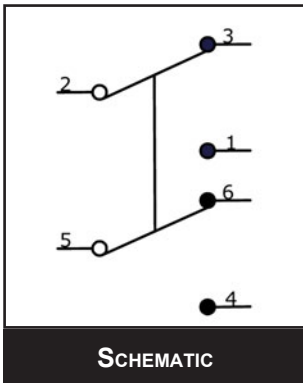
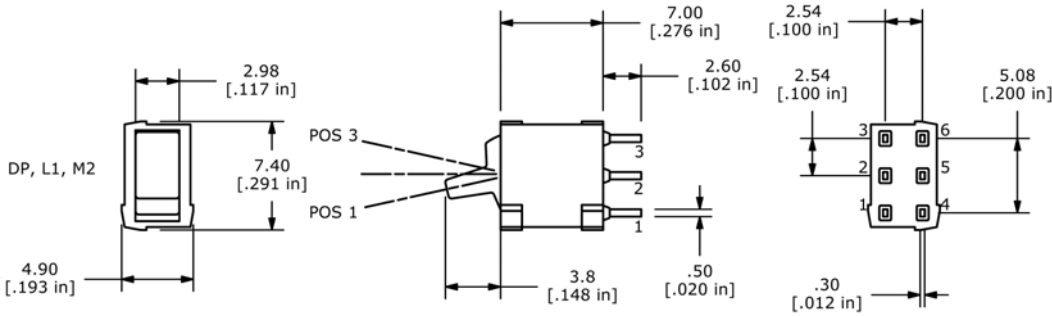

SWITCH FUNCTION		
POS. 1	POS. 2	POS. 3
ON	NONE	ON
5-6; 2-3	NONE	5-4; 2-1



# 400U SERIES ROCKER SWITCH

## M6 TERMINATION

### Rocker Actuator

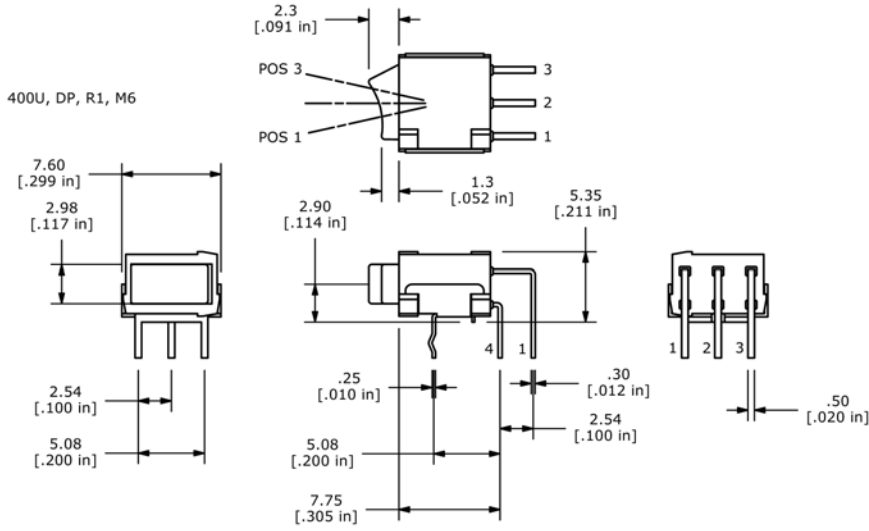

### Lever Actuator

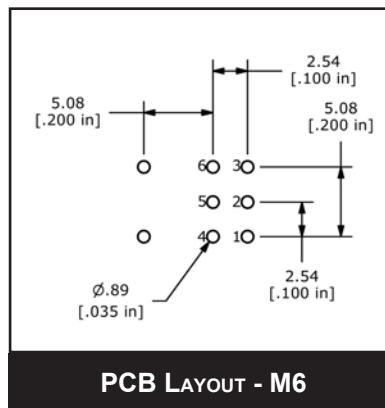
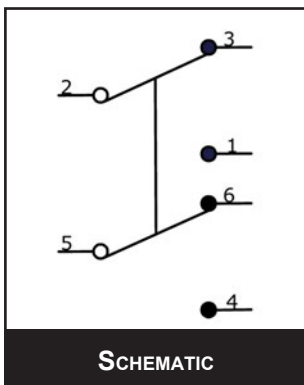
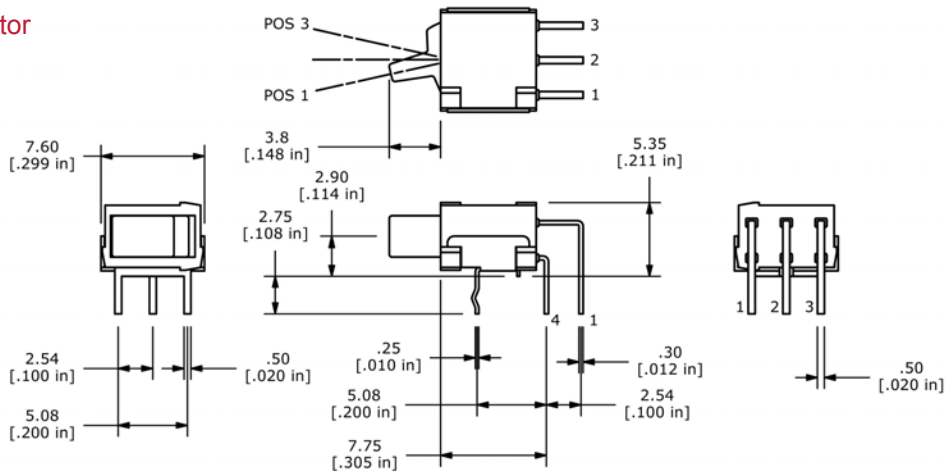

SWITCH FUNCTION		
POS. 1	POS. 2	POS. 3
ON	NONE	ON
5-6; 2-3	NONE	5-4; 2-1



# 400U SERIES ROCKER SWITCH

## M7 TERMINATION

### Rocker Actuator

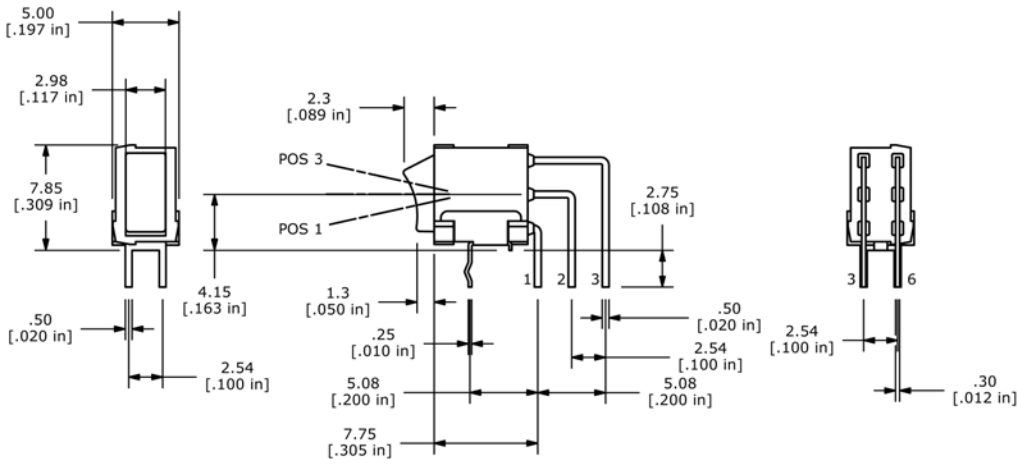

### Lever Actuator

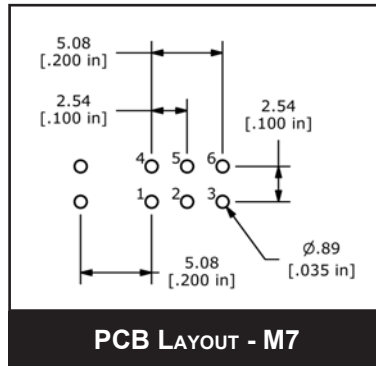
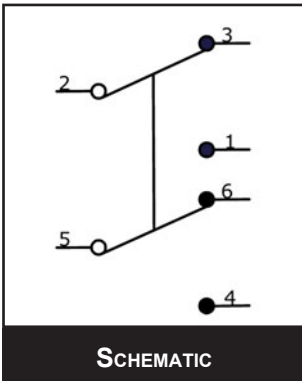
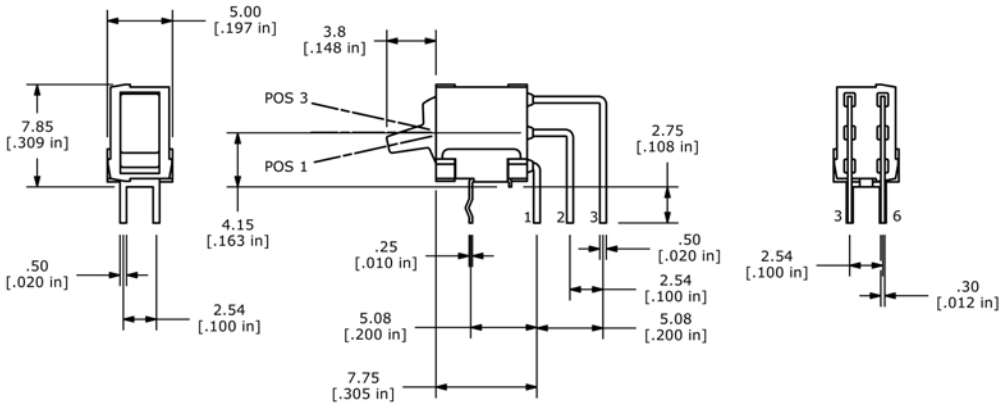

SWITCH FUNCTION		
POS. 1	POS. 2	POS. 3
ON	NONE	ON
5-6; 2-3	NONE	5-4; 2-1



## X-ON Electronics

Largest Supplier of Electrical and Electronic Components

*Click to view similar products for [Rocker Switches](#) category:*

*Click to view products by [E-Switch](#) manufacturer:*

Other Similar products are found below :

[LTI LA6E-1S-WH-RC-FN12VXCR1](#) [6-1571986-9](#) [8007K26N324V52](#) [8055K32Z7V](#) [8055K52Z7V](#) [8138K20E6M50](#) [84206L](#) [84312LX](#)  
[PREDD5-07F-BB0GW](#) [999-16716-002](#) [999-16716-003](#) [999-16716-004](#) [A101J1V3Q004](#) [A101J2ZQ004](#) [A101J4ZQ004](#) [A101J51CB0004](#)  
[A103J1ZQ004](#) [A201J1AQ004](#) [A201J3ZB004](#) [A201J50ZQ004](#) [A203J51ZQ0004](#) [A435S1YZQ](#) [H8500XBBBBBL-A](#) [H8653VBBG2577W](#)  
[HB130CHNWWNAAC](#) [R13112ABB-602W](#) [1251.0303](#) [AE205J60V3B004](#) [1352.0107](#) [1500G51E](#) [1571099-3](#) [1571987-4](#) [1571987-5](#)  
[1571989-7](#) [1571988-5](#) [B123J77V7B2](#) [B226J50W4Q22P](#) [B433J37ZQ22M](#) [160212E](#) [1634200-7](#) [1801.1164](#) [1839.1502](#) [PANEL-PLUG-VHP-](#)  
[BLACK](#) [PANEL-PLUG-VHP-WT](#) [K1ABBSCADN](#) [K2ABAAAAAA](#) [KG312A2DXD246X](#) [250011E714](#) [2600HM11E](#) [2600R21E](#)