

800U SERIES PUSHBUTTON SWITCH

ANTI-VANDAL SWITCHES
DETECTOR SWITCHES
DIP SWITCHES
KEYLOCK SWITCHES
NAVIGATION SWITCHES
PUSHBUTTON SWITCHES
ROCKER SWITCHES
ROTARY SWITCHES
SLIDE SWITCHES
SNAP ACTION SWITCHES
TACTILE SWITCHES
TOGGLE SWITCHES
CAP OPTIONS

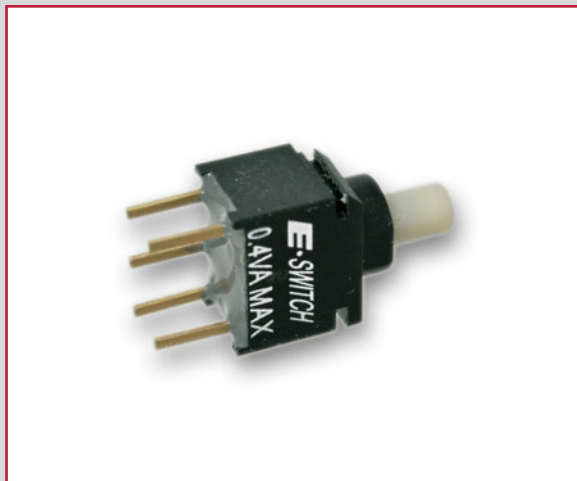

APPLICATIONS / MARKETS

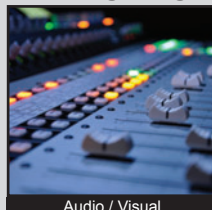

Audio / Visual



Consumer Electronics

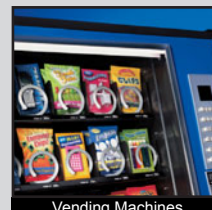

Vending Machines

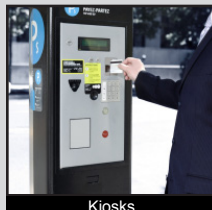

Kiosks

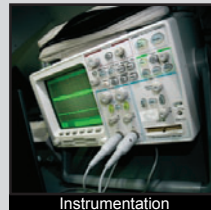

Instrumentation

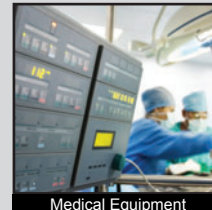

Medical Equipment

RoHS

SPECIFICATIONS

Electrical Rating: 0.4VA @ 20V Max (AC or DC)
Mechanical Life: 40,000 Cycles
Electrical Life: 6,000 Cycles
Contact Resistance: 100mΩ initial
Insulation Resistance: 500 MΩ Min.
Dielectric Strength: 500VAC
Operating/Storage Temperature: -30°C to 85°C
Travel: 1.0mm
Circuit Function: SPDT, DPDT
Actuation Force: 250 gf

FEATURES & BENEFITS

- Ultra-miniature in size
- IP67 rated
- Multiple termination options
- Multiple cap colors
- Single or double pole

PART NUMBER CONFIGURATOR

Series	Circuit	Function	Actuator	Bushing	Terminal	Contact Material	Seal	Cap	Cap Color
800U	SP - Single Pole DP - Double Pole	8 - ON - (ON)*	P1 - 3.30 High	A1 - 1.6 High	M2 - PC thru-hole M6 - Right Angle, PC thru-hole M7 - Vertical right angle, PC thru-hole	R - Gold	E - Epoxy	None R1 - 4.0 dia. round	None BLK - Black RED - Red WHT - White

CAP CONFIGURATOR*

Series	Cap Style	Cap Color
800U	R1	BLK - Black RED - Red WHT - White

* () denotes momentary

*You can order just the switch with or without the cap using the first ordering code above, or you can order the cap as a separate part number using the smaller ordering code directly above.

Specifications subject to change without notice



E-SWITCH®

www.e-switch.com

800.867.2717

2

800U SERIES PUSHBUTTON SWITCH

SPDT DIMENSIONS

M2 Termination

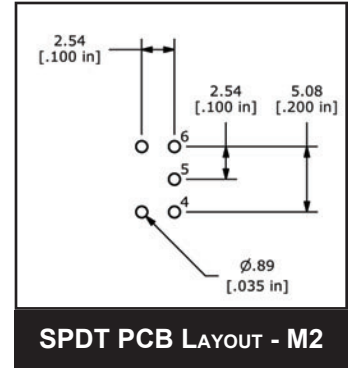
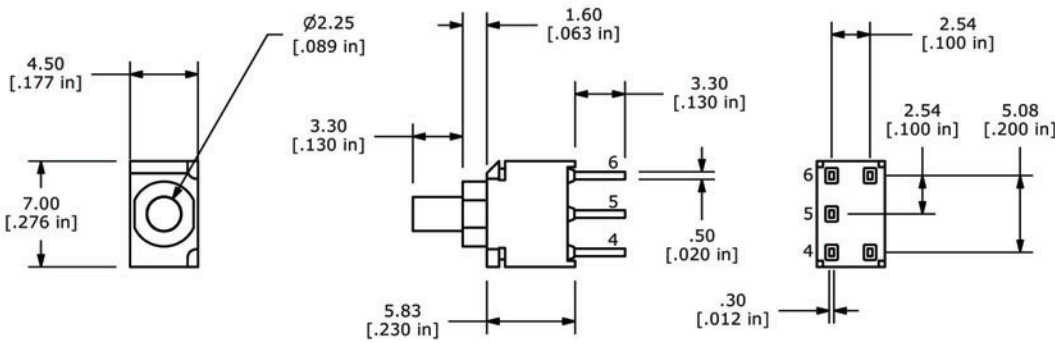

SPDT PCB LAYOUT - M2

M6 Termination

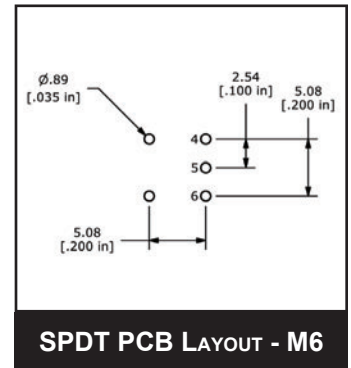
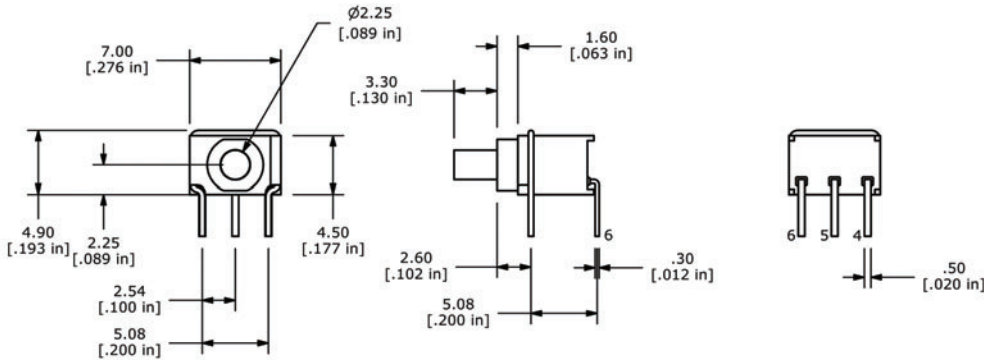

SPDT PCB LAYOUT - M6

M7 Termination

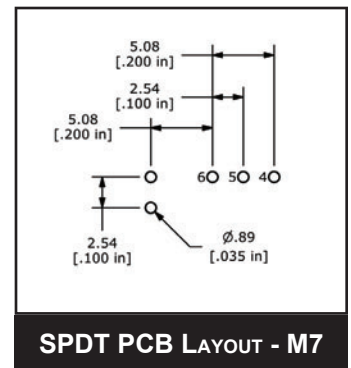
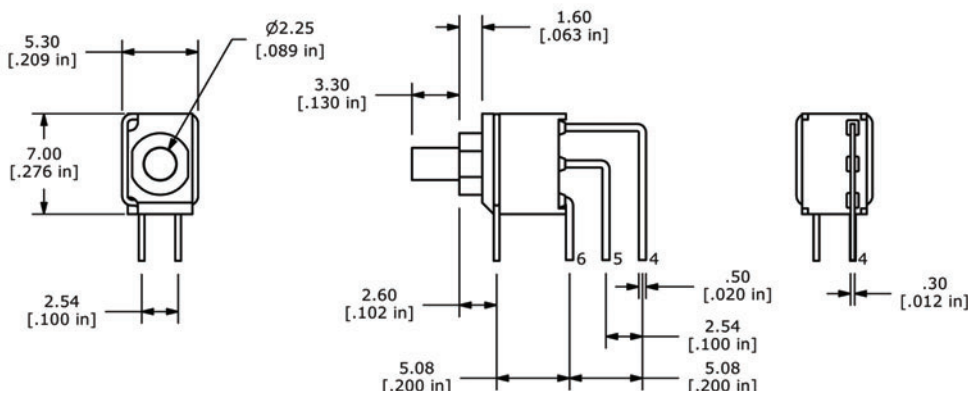

SPDT PCB LAYOUT - M7

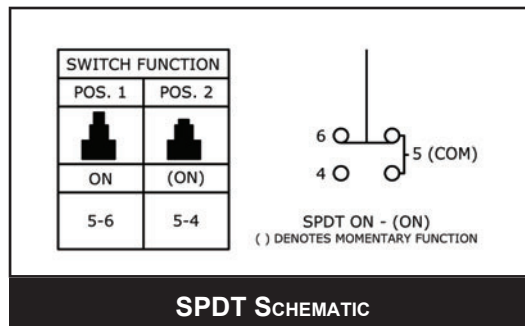

SPDT SCHEMATIC



800U SERIES PUSHBUTTON SWITCH

DPDT DIMENSIONS

M2 Termination

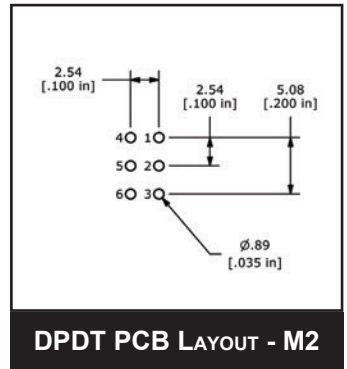
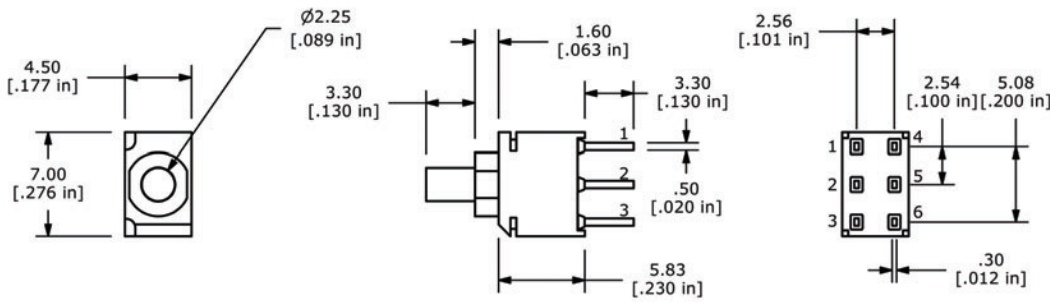

DPDT PCB LAYOUT - M2

M6 Termination

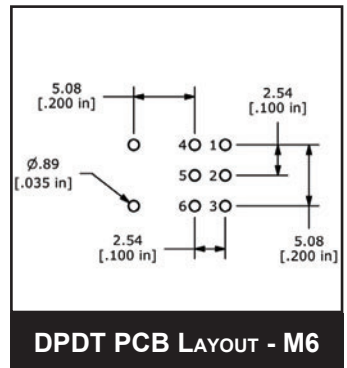
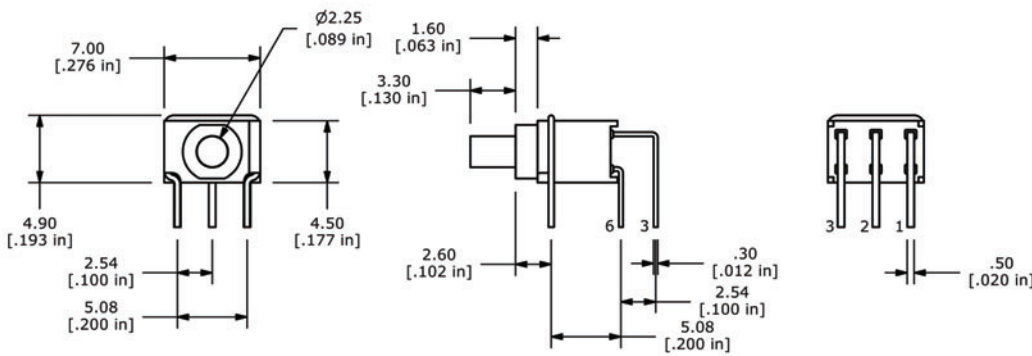

DPDT PCB LAYOUT - M6

M7 Termination

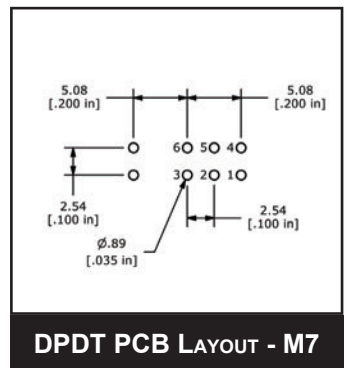
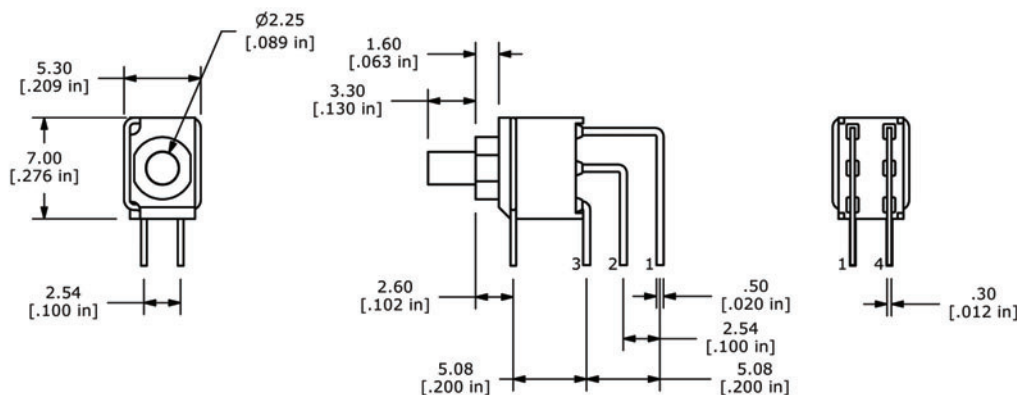

DPDT PCB LAYOUT - M7

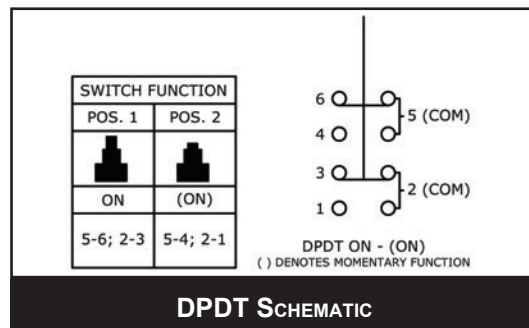

DPDT SCHEMATIC



BUTTON POSITIONING

For specifications, please refer to the dimensions on previous pages.

M2 Button

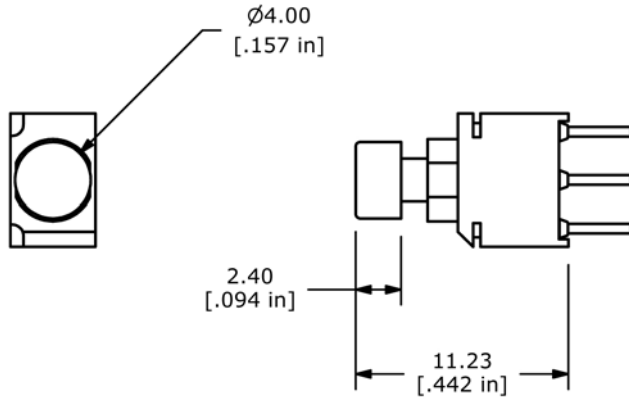

M6 Button

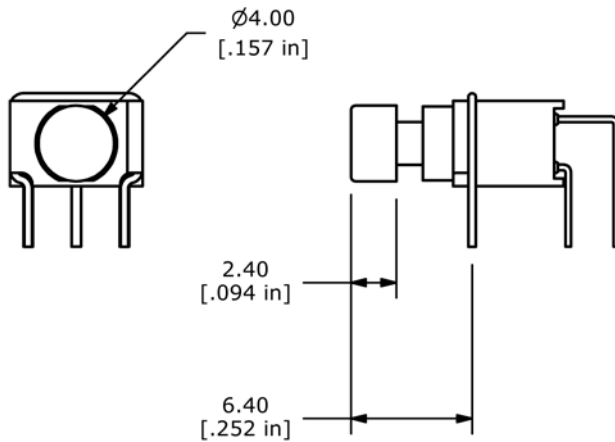

M7 Button

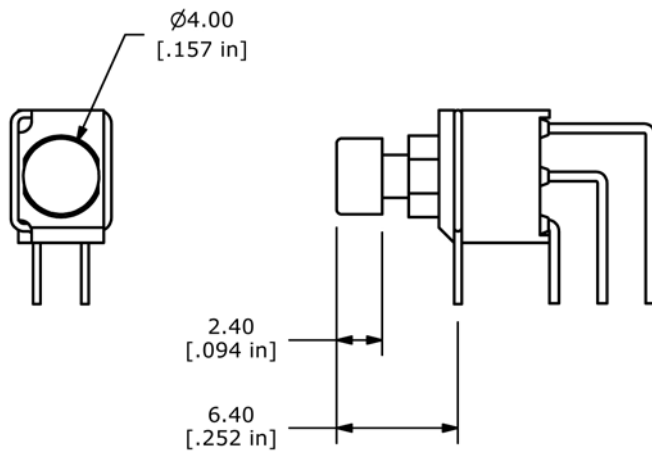

X-ON Electronics

Largest Supplier of Electrical and Electronic Components

Click to view similar products for [Switch Fixings](#) category:

Click to view products by [E-Switch](#) manufacturer:

Other Similar products are found below :

[893102000](#) [00-5150](#) [LZZ1A](#) [0098.9234](#) [61-9451.0](#) [M2PA-5011](#) [630155](#) [635401](#) [6PA113](#) [6PA147-E6](#) [6PA148-E6](#) [6PA32](#) [6PA9](#) [700106](#)
[700109](#) [700303A56](#) [700C1GRY](#) [700C2GRN](#) [704-6001](#) [704.960.9](#) [704.965.2](#) [704.965.6](#) [704.966.0](#) [7089-3](#) [710082-B11](#) [71M1048](#)
[757200264](#) [764300000](#) [MHU35](#) [MHU37](#) [807039-1](#) [825.003.011](#) [825.005.011](#) [825.053.011](#) [825.055.011](#) [826.000.071](#) [827.020.011](#)
[827.400.021](#) [835.900.023](#) [MML52C10C](#) [MML52E10C](#) [MML92HGH](#) [MML93K](#) [84211M02CNNS](#) [84212M02CNNS](#) [84217A8.0LNOS](#)
[842.500.011](#) [843.000.011](#) [843187-000](#) [843487-000](#)