

KAS SERIES DIP SWITCH

ANTI-VANDAL SWITCHES
 DETECTOR SWITCHES
 DIP SWITCHES
 KEYLOCK SWITCHES
 NAVIGATION SWITCHES
 PUSHBUTTON SWITCHES
 ROCKER SWITCHES
 ROTARY SWITCHES
 SLIDE SWITCHES
 SNAP ACTION SWITCHES
 TACTILE SWITCHES
 TOGGLE SWITCHES
 CAP OPTIONS

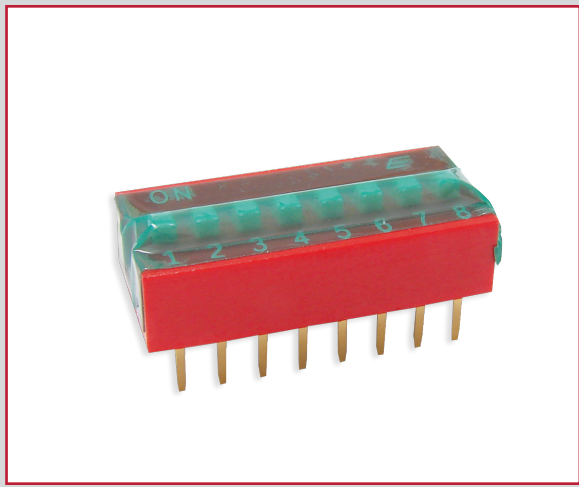

APPLICATIONS / MARKETS

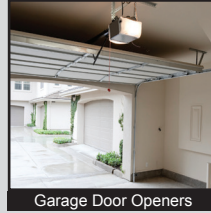

Garage Door Openers

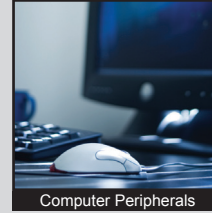

Computer Peripherals

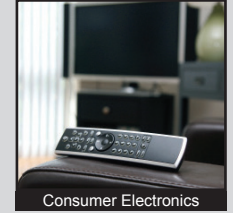

Consumer Electronics



Instrumentation



Telecommunication



Medical Equipment

RoHS

SPECIFICATIONS

Electrical Rating: 100mA @ 50VDC Non-Switching
 25mA @ 24VDC Switching
Life Expectancy: 2,000 Cycles
Contact Resistance: 100mΩ Max.
Insulation Resistance: 100 MΩ Min. at 500VDC
Dielectric Strength: 100VAC for 1 min.
Operating Temperature: -20°C to 85°C
Storage Temperature: -40°C to 85°C
Travel: 2.0mm Typical
Contact Arrangement: SPST each position

FEATURES & BENEFITS

- Through hole (PCB Pin) termination
- From 2 to 12 positions
- Top seal optional
- Tube packaging

PART NUMBER CONFIGURATOR

P Series	Model No.	Termination	Circuit	No. of Positions	Actuator	Seal
<input type="text" value="KA"/>	<input type="text" value="S - Slide Type"/>	<input type="text" value="1 - PC Pin
2 - Right Angle
PC Pin (Extended Actuator Only)"/>	<input type="text" value="1 - SPST"/>	<input type="text" value="02 - 2 positions
03 - 3 positions
04 - 4 positions
05 - 5 positions
06 - 6 positions
07 - 7 positions
08 - 8 positions
09 - 9 positions
10 - 10 positions
12 - 12 positions"/>	<input type="text" value="R - Recessed Actuator
E - Extended Actuator"/>	<input type="text" value="None - Standard Unsealed
T - Top Tape Sealed"/>

Switches are supplied in standard IC tubes with all poles in the "OFF" position

Specifications subject to change without notice 10.19.2017



E-SWITCH®

www.e-switch.com

800.867.2717

KAS SERIES DIP SWITCH

BODY DIMENSIONS/ POSITION OPTIONS

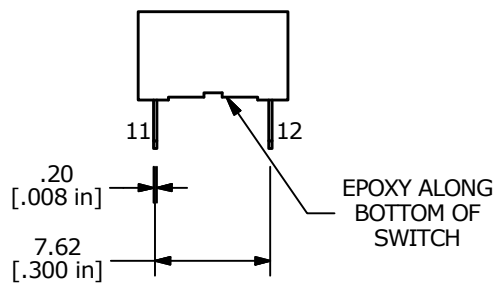
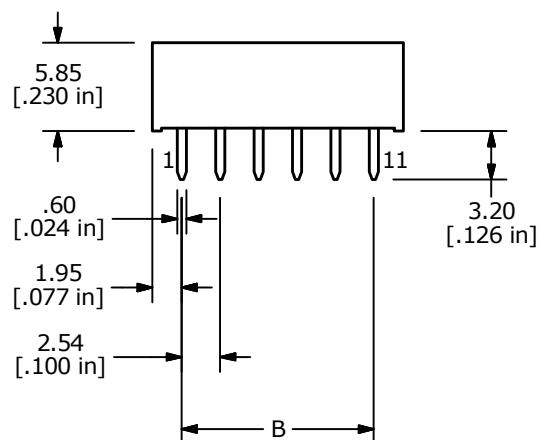
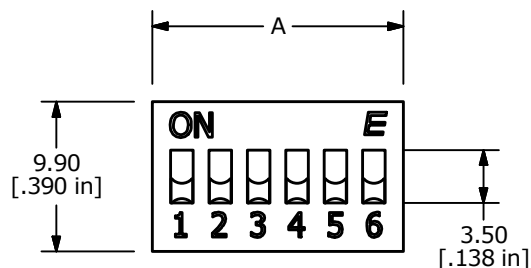
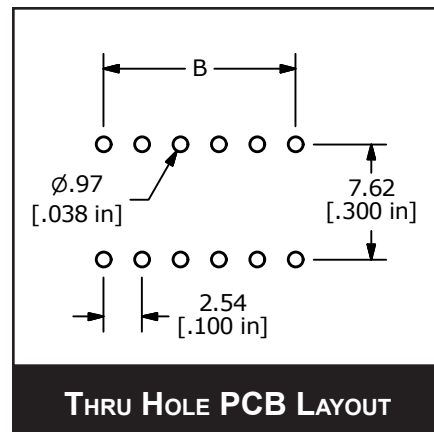
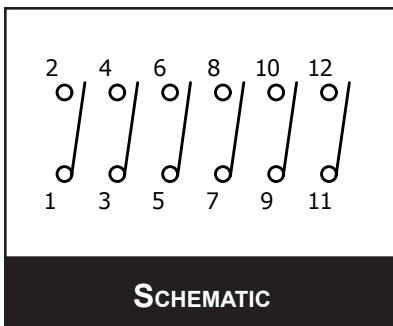

SHOWN WITH 1 - PC PIN
R - RECESSED ACTUATOR

POSITIONS	2	3	4	5	6	7	8	9	10	12
DIM A	6.44 [.254]	8.98 [.354]	11.52 [.454]	14.06 [.554]	16.6 [.654]	19.14 [.754]	21.68 [.854]	24.22 [.954]	26.76 [1.054]	31.84 [1.254]
DIM B	2.54 [.100]	5.08 [.200]	7.62 [.300]	10.16 [.400]	12.7 [.500]	15.24 [.600]	17.78 [.700]	20.32 [.800]	22.86 [.900]	27.94 [1.100]



KAS SERIES DIP SWITCH

BODY DIMENSIONS/ POSITION OPTIONS

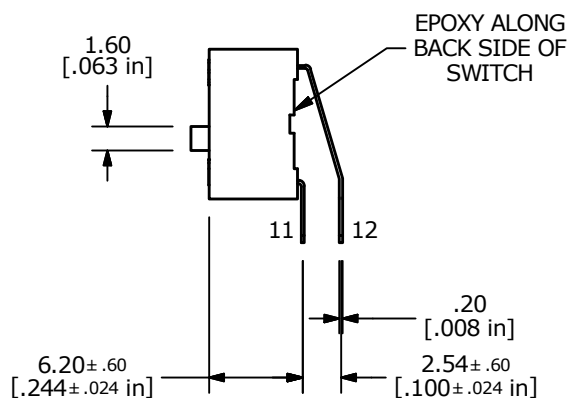
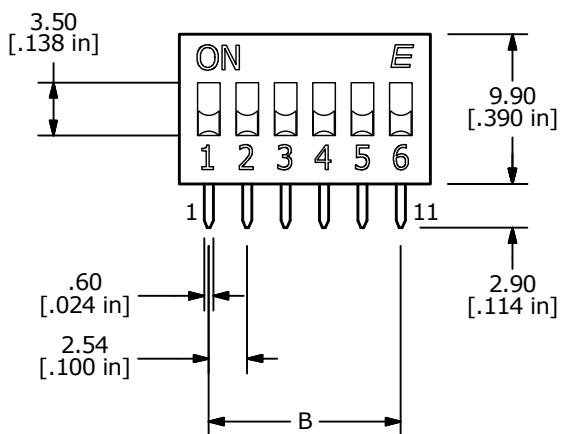
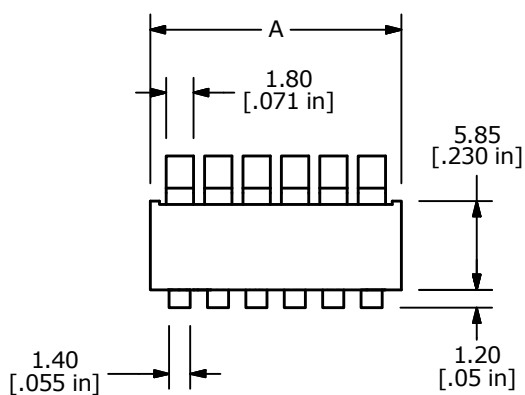
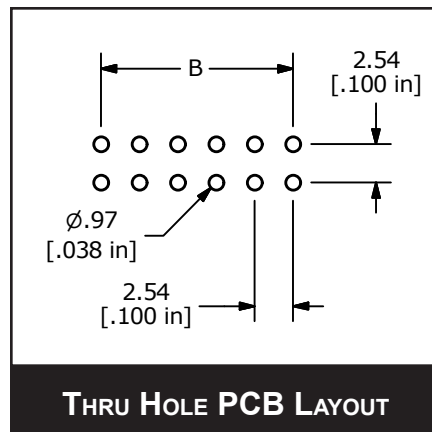
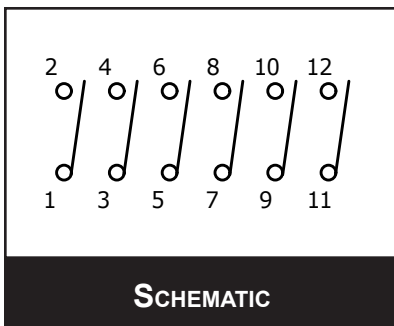

SHOWN WITH 2 - RIGHT ANGLE PC PIN
E - EXTENDED ACTUATOR

POSITIONS	2	3	4	5	6	7	8	9	10	12
DIM A	6.44 [.254]	8.98 [.354]	11.52 [.454]	14.06 [.554]	16.6 [.654]	19.14 [.754]	21.68 [.854]	24.22 [.954]	26.76 [1.054]	31.84 [1.254]
DIM B	2.54 [.100]	5.08 [.200]	7.62 [.300]	10.16 [.400]	12.7 [.500]	15.24 [.600]	17.78 [.700]	20.32 [.800]	22.86 [.900]	27.94 [1.100]



X-ON Electronics

Largest Supplier of Electrical and Electronic Components

Click to view similar products for [DIP Switches/SIP Switches](#) category:

Click to view products by [E-Switch](#) manufacturer:

Other Similar products are found below :

[78M03S](#) [79B10T](#) [8136-475G4T](#) [G7G-1A2-CB-DC12](#) [H7CZL8AC100240](#) [A7SS-M](#) [A8CA-201](#) [DBS1008](#) [DRR60016](#) [DRS4016](#) [1825008-1](#)
[1825444-1](#) [25.350.0653.0](#) [SBS 5004 TG](#) [SDA10H1BDA](#) [97R06ST](#) [A2C-2A5](#) [1825444-7](#) [ADE08SA04](#) [ADE12S04](#) [192960010](#) [2-1825058-8](#)
[25.330.0653.1](#) [25.352.0353.0](#) [CXDRIVEV2X](#) [IKN0600000](#) [IKN0800000](#) [LA2-002-DC24](#) [DBS1003](#) [438872000](#) [DRD10CRAE04](#) [DSR02T](#)
[DSS 208 N](#) [E2FMX2D1M1TGJ03M](#) [NDI10H](#) [219-9MSTP](#) [204-6ES](#) [EPM02FV](#) [701521596](#) [NDS08V](#) [76SB05](#) [79A10](#) [TD06H0SK1](#)
[Z7.255.9027.0](#) [1-1825058-3](#) [1825428-4](#) [206-8ST-ON](#) [219-10LPSTF](#) [E3ZG6111D03M](#) [G4D212PUSTV2DC5](#)