

SCHEMATIC

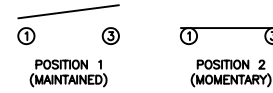

SPECIFICATIONS

FUNCTION:
1P1T OFF-(ON)

RATINGS:
ANSI/UL 1054 and CAN/CSA C22.2 No.55 (E194579):
16A 125VAC [UR, cUR]
1/2HP 125VAC [UR, cUR]
3/4HP 250VAC [UR, cUR]

EN 61058-1:2002:
16(6)A 250V~ 1E4 T125/55 [ENEC14]
10(4)A 250V~ 5E4 T125/55 [ENEC14]

CONTACT RESISTANCE:
Initial: 35mΩ Max. at 50VAC

INSULATION RESISTANCE:
100MΩ Min. at 500VDC

DIELECTRIC STRENGTH:
1,500VAC For 1 Minute

ELECTRICAL LIFE:
6,000 Cycles [UR, cUR]
10,000 Cycles [ENEC14]
50,000 Cycles [ENEC14]

TEMPERATURE:
Operating: -20°C to 105°C [UR, cUR]
Operating: -20°C to 125°C [ENEC14]

APPROVALS:

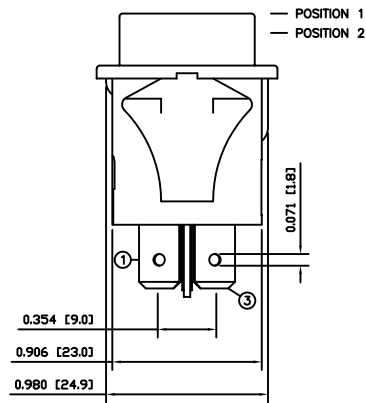
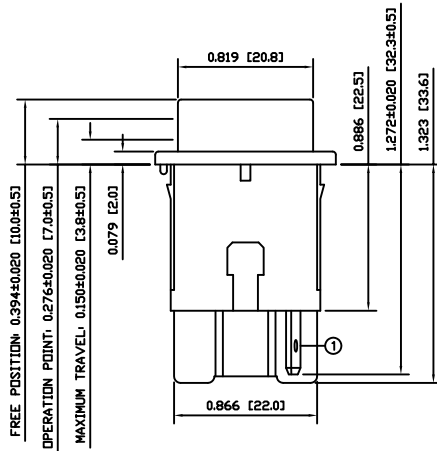
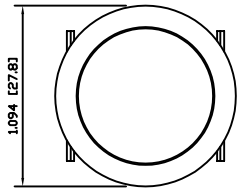

COLORS AND MARKINGS

BODY:
White

ACTUATOR:
White
Glossy Finish

MARKINGS:
None

MARKING COLOR:
None

MATERIALS

BODY:
Polyamide 6/6 (PA66), UL94 V-2

ACTUATOR:
Polyamide 6/6 (PA66), UL94 V-2

CONTACT CARRIER:
Polyamide 6/6 (PA66), UL94 V-2

SPRINGS:
Steel

MOBILE CONTACT:
Silver Plated Copper

CONTACTS:
Silver Plated Copper

TERMINALS:
Silver Plated Copper

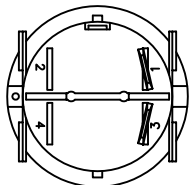

SUGGESTED PANEL CUTOUT

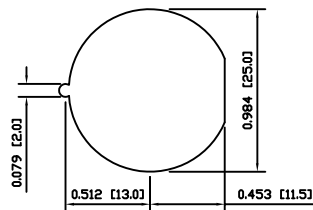

ALTERNATE PANEL CUTOUT

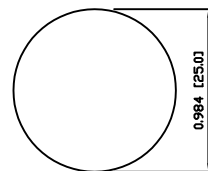

BODY	A	09/08/07	CAB
COLORS	A	09/08/07	CAB
MATERIALS	A	09/08/07	CAB
SPECIFICATIONS	B	10/05/25	CAB
REFERENCE	REV.	DATE	BY

THE INFORMATION CONTAINED IN THIS DOCUMENT IS PROPRIETARY TO E-SWITCH AND IS NOT TO BE COPIED OR TRANSFERRED

B	REMOVED SEMKO RATING	23315	04/16/18	MJR
A	INITIAL RELEASE	20017	11/06/20	CAB
REV.	DESCRIPTION	PCR	DATE	DRAWN BY

DIMENSIONS	
INCHES [MILLIMETERS]	
GENERAL TOLERANCES	
±0.008 [±0.2] / ±1'	
SCALE	PROJECTION
DRAWING NOT TO SCALE	1:1

PR144C2200			
ITEM NUMBER	DATE	REVISION	
38-PR144C2200	JUNE 20, 2011	B	

X-ON Electronics

Largest Supplier of Electrical and Electronic Components

Click to view similar products for [Pushbutton Switches](#) category:

Click to view products by [E-Switch](#) manufacturer:

Other Similar products are found below :

[8940K2012](#) [LW1L-M1C10V-A](#) [LW1L-M1C70-A](#) [LW2L-A1C20M-GD](#) [LW2L-M1C20M-A](#) [60324L](#) [M22-D-R-GB0/K11](#) [M7E-HRN2](#)
[67021K512](#) [67081K512X](#) [701PB580](#) [7190K101](#) [7199K101](#) [810K12910](#) [810KSV30B](#) [MML21EA2ADK](#) [MML21KA3ABK](#)
[MML23KA3AC05K-001](#) [MML23KW3AA01W](#) [8418K2](#) [8442K3](#) [8450K1](#) [860K11911T01A](#) [861901](#) [861K11911T01A07](#)
[861K13810T00A14](#) [861K13911](#) [8646AB6X718UL](#) [8646ABUL](#) [9001KXRK](#) [907AYY100](#) [PMHD155A1](#) [95-313.000](#)
[9533CD4+U574+U4922](#) [95-414.000](#) [99-450.837](#) [99-453.837](#) [PV3H2B0NN-341](#) [1203MRA](#) [A22NZBGANGA](#) [A22NZBMMNGA](#)
[A22NZBNANGA](#) [A22NZMPATRA](#) [A2PMA1X03EC56](#) [A3A-5123-02](#) [A3A-7140](#) [A3A-7310](#) [A3A-7340](#) [A3U-TMW-A2C-5M](#) [A595](#)