

PV2 SERIES ANTI-VANDAL SWITCH

ANTI-VANDAL SWITCHES
DETECTOR SWITCHES
DIP SWITCHES
KEYLOCK SWITCHES
NAVIGATION SWITCHES
PUSHBUTTON SWITCHES
ROCKER SWITCHES
ROTARY SWITCHES
SLIDE SWITCHES
SNAP ACTION SWITCHES
TACTILE SWITCHES
TOGGLE SWITCHES
CAP OPTIONS



APPLICATIONS / MARKETS



SPECIFICATIONS

Electrical Rating: 2A, 48VDC
Mechanical Life: 1,000,000 Cycles
Electrical Life: 200,000 Cycles
Contact Resistance: 50mΩ Max.
Insulation Resistance: 1000 MΩ Min.
Dielectric Strength: 2,000VAC
Operating/Storage Temperature: -20°C to 55°C
Travel: 2.50mm
Moisture Protection: IP65
Contact Arrangement: SPST Off-(On)
Actuation Force: 4 N
Panel Thickness: 1-6mm
Mounting Nut Torque: 0.8Nm

FEATURES & BENEFITS

- 16mm panel cutout
- Solder or screw termination options
- Flat, high or domed actuator options
- IP65 rated

PART NUMBER CONFIGURATOR

Series	Actuator Options	Terminal Options	Function Options	Rating Options	Body Finish Options	Actuator Finish Options	Contact Material Options	Marking Options
<input type="text" value="PV2"/>	<input type="text" value="F - Flat
H - High
S - Domed"/>	<input type="text" value="2 - Solder
6 - Screw"/>	<input type="text" value="4 - Off - (On)*"/>	<input type="text" value="0 - 2A,
48VDC"/>	<input type="text" value="G - Gold
N - Nickel
S - Polished
Stainless
B - Brushed
Stainless
1 - Black Anodized"/>	<input type="text" value="G - Gold
N - Nickel
S - Polished
Stainless
B - Brushed
Stainless
1 - Black Anodized"/>	<input type="text" value="NONE - Silver
G - Gold"/>	<input type="text" value="NONE - Non-Illuminated
M01 - Power Symbol"/>

NOTES:
*(ON) Denotes function is momentary

Specifications subject to change without notice 6.10.2020



E-SWITCH®

www.e-switch.com

800.867.2717

1

PV2 SERIES ANTI-VANDAL SWITCH

SOLDER TERMINATION

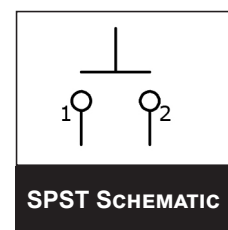
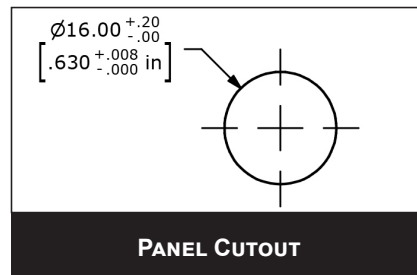
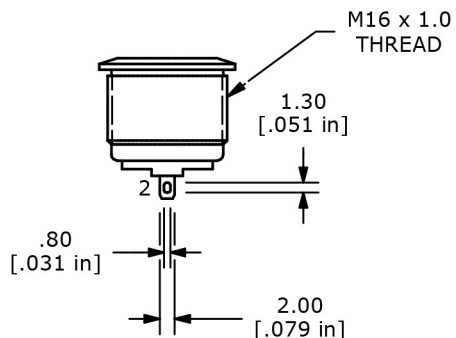
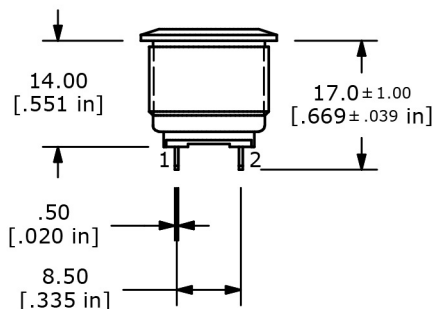
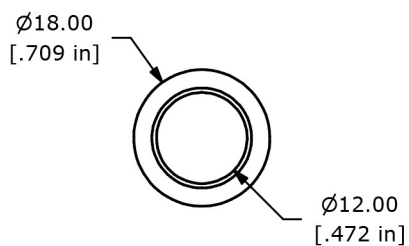

SCREW TERMINATION

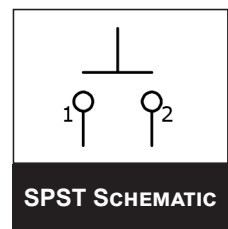
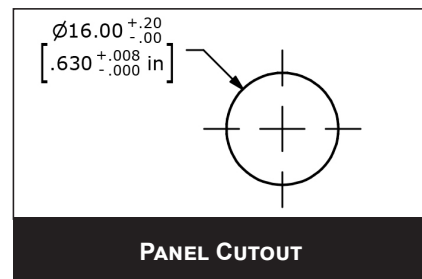
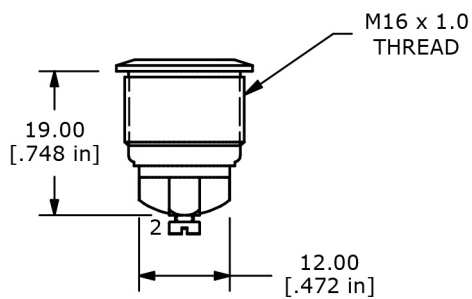
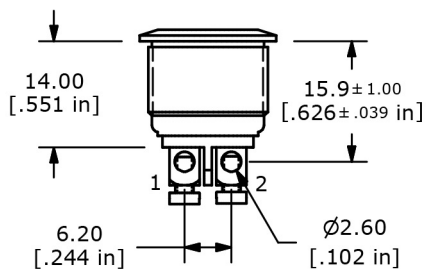
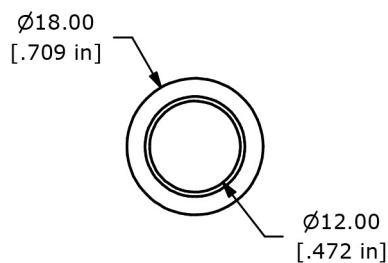

PV2 SERIES ANTI-VANDAL SWITCH

ANTI-VANDAL SWITCHES
 DETECTOR SWITCHES
 DIP SWITCHES
 KEYLOCK SWITCHES
 NAVIGATION SWITCHES
 PUSHBUTTON SWITCHES
 ROCKER SWITCHES
 ROTARY SWITCHES
 SLIDE SWITCHES
 SNAP ACTION SWITCHES
 TACTILE SWITCHES
 TOGGLE SWITCHES
 CAP OPTIONS

ACTUATOR OPTIONS

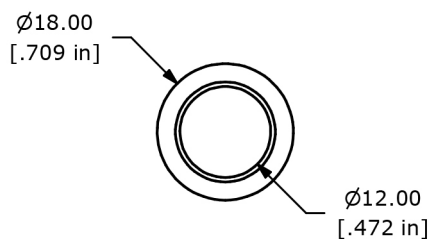

FLAT ACTUATOR

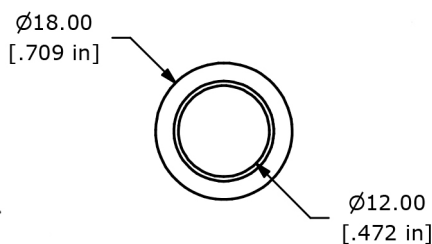

HIGH ACTUATOR

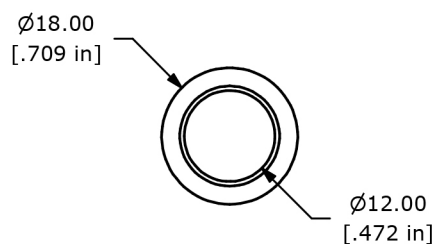

DOMED ACTUATOR

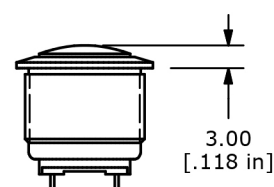
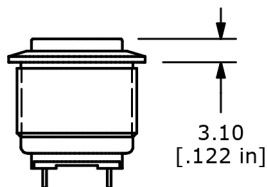
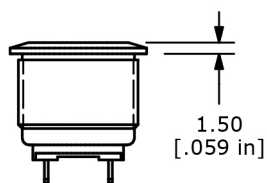

GRAPHIC OPTIONS

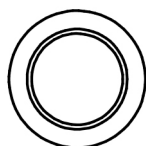

NONE

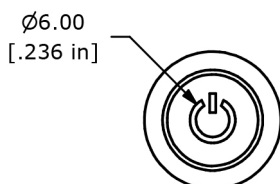

M01POWERSYMBOL



X-ON Electronics

Largest Supplier of Electrical and Electronic Components

Click to view similar products for [Pushbutton Switches](#) category:

Click to view products by [E-Switch](#) manufacturer:

Other Similar products are found below :

[8940K2012](#) [LW1L-M1C10V-A](#) [LW1L-M1C70-A](#) [LW2L-A1C20M-GD](#) [LW2L-M1C20M-A](#) [60324L](#) [M22-D-R-GB0/K11](#) [M7E-HRN2](#)
[67021K512](#) [67081K512X](#) [701PB580](#) [7190K101](#) [7199K101](#) [810K12910](#) [810KSV30B](#) [MML21EA2ADK](#) [MML21KA3ABK](#)
[MML23KA3AC05K-001](#) [MML23KW3AA01W](#) [8418K2](#) [8442K3](#) [8450K1](#) [860K11911T01A](#) [861901](#) [861K11911T01A07](#)
[861K13810T00A14](#) [861K13911](#) [8646AB6X718UL](#) [8646ABUL](#) [9001KXRK](#) [907AYY100](#) [PMHD155A1](#) [95-313.000](#)
[9533CD4+U574+U4922](#) [95-414.000](#) [99-450.837](#) [99-453.837](#) [PV3H2B0NN-341](#) [1203MRA](#) [A22NZBGANGA](#) [A22NZBMMNGA](#)
[A22NZBNANGA](#) [A22NZMPATRA](#) [A2PMA1X03EC56](#) [A3A-5123-02](#) [A3A-7140](#) [A3A-7310](#) [A3A-7340](#) [A3U-TMW-A2C-5M](#) [A595](#)