

# PV2 SERIES ANTI-VANDAL SWITCH

ANTI-VANDAL SWITCHES  
DETECTOR SWITCHES  
DIP SWITCHES  
KEYLOCK SWITCHES  
NAVIGATION SWITCHES  
PUSHBUTTON SWITCHES  
ROCKER SWITCHES  
ROTARY SWITCHES  
SLIDE SWITCHES  
SNAP ACTION SWITCHES  
TACTILE SWITCHES  
TOGGLE SWITCHES  
CAP OPTIONS

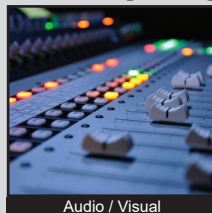

## APPLICATIONS / MARKETS



## SPECIFICATIONS

**Electrical Rating:** 2A, 48VDC  
**Mechanical Life:** 1,000,000 Cycles  
**Electrical Life:** 200,000 Cycles  
**Contact Resistance:** 50mΩ Max.  
**Insulation Resistance:** 1000 MΩ Min.  
**Dielectric Strength:** 2,000VAC  
**Operating/Storage Temperature:** -20°C to 55°C  
**Travel:** 2.50mm  
**Moisture Protection:** IP65  
**Contact Arrangement:** SPST Off-(On)  
**Actuation Force:** 4 N  
**Panel Thickness:** 1-6mm  
**Mounting Nut Torque:** 0.8Nm

## FEATURES & BENEFITS

- 16mm panel cutout
- Solder or screw termination options
- Flat, high or domed actuator options
- IP65 rated

## PART NUMBER CONFIGURATOR

Series	Actuator Options	Terminal Options	Function Options	Rating Options	Body Finish Options	Actuator Finish Options	Contact Material Options	Marking Options
<input type="text" value="PV2"/>	<input type="text" value="F - Flat&lt;br/&gt;H - High&lt;br/&gt;S - Domed"/>	<input type="text" value="2 - Solder&lt;br/&gt;6 - Screw"/>	<input type="text" value="4 - Off - (On)*"/>	<input type="text" value="0 - 2A,&lt;br/&gt;48VDC"/>	<input type="text" value="G - Gold&lt;br/&gt;N - Nickel&lt;br/&gt;S - Polished&lt;br/&gt;Stainless&lt;br/&gt;B - Brushed&lt;br/&gt;Stainless&lt;br/&gt;1 - Black Anodized"/>	<input type="text" value="G - Gold&lt;br/&gt;N - Nickel&lt;br/&gt;S - Polished&lt;br/&gt;Stainless&lt;br/&gt;B - Brushed&lt;br/&gt;Stainless&lt;br/&gt;1 - Black Anodized"/>	<input type="text" value="NONE - Silver&lt;br/&gt;G - Gold"/>	<input type="text" value="NONE - Non-Illuminated&lt;br/&gt;M01 - Power Symbol"/>

NOTES:  
\*(ON) Denotes function is momentary

Specifications subject to change without notice 6.10.2020



E-SWITCH®

www.e-switch.com

800.867.2717

1

# PV2 SERIES ANTI-VANDAL SWITCH

## SOLDER TERMINATION

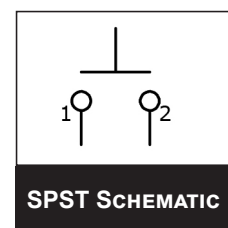
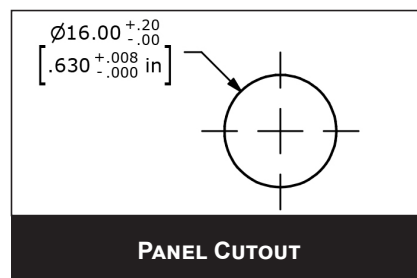
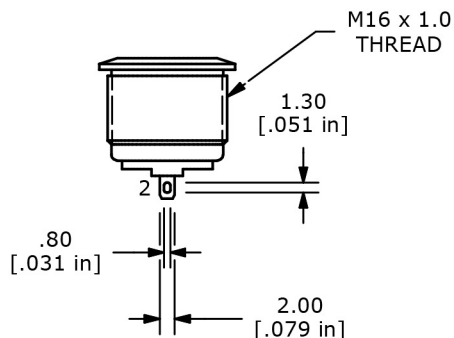
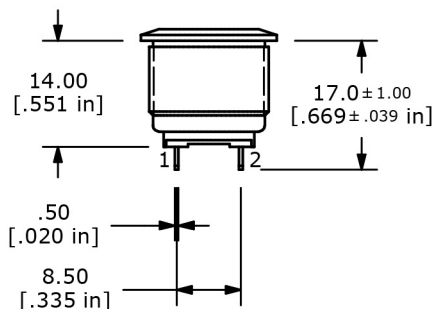
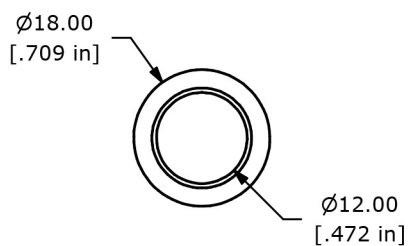

## SCREW TERMINATION

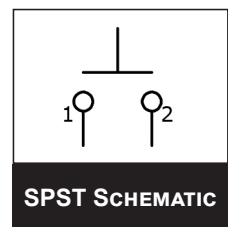
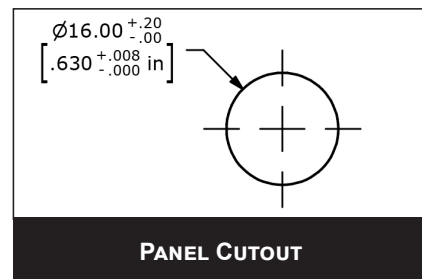
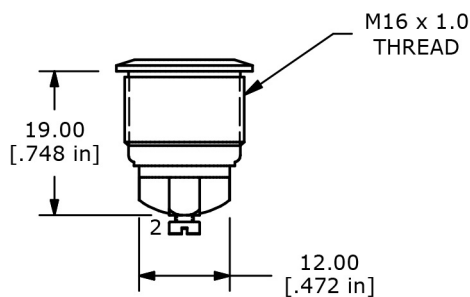
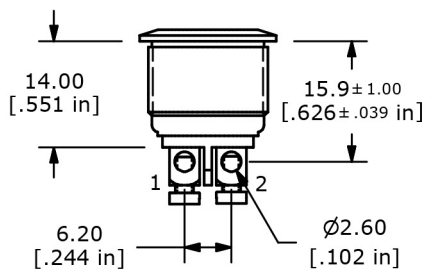
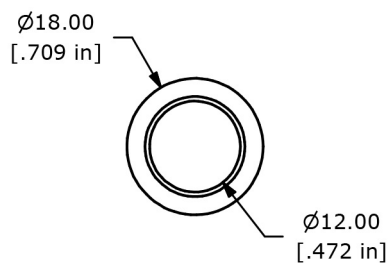

# PV2 SERIES ANTI-VANDAL SWITCH

ANTI-VANDAL SWITCHES  
 DETECTOR SWITCHES  
 DIP SWITCHES  
 KEYLOCK SWITCHES  
 NAVIGATION SWITCHES  
 PUSHBUTTON SWITCHES  
 ROCKER SWITCHES  
 ROTARY SWITCHES  
 SLIDE SWITCHES  
 SNAP ACTION SWITCHES  
 TACTILE SWITCHES  
 TOGGLE SWITCHES  
 CAP OPTIONS

## ACTUATOR OPTIONS

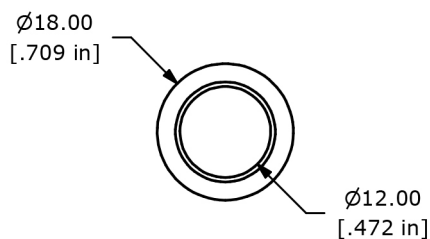

FLAT ACTUATOR

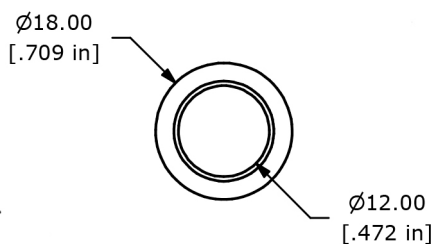

HIGH ACTUATOR

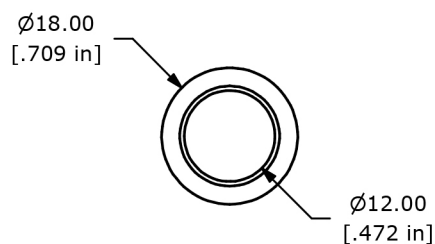

DOMED ACTUATOR

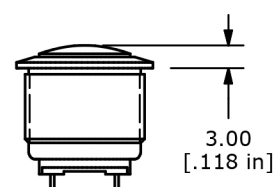
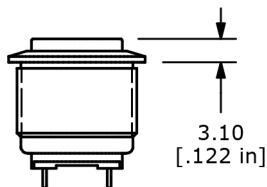
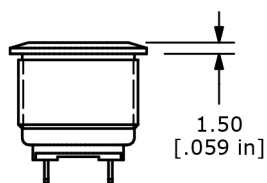

## GRAPHIC OPTIONS

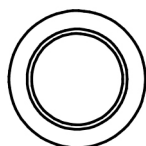

NONE

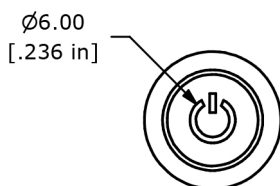

M01POWERSYMBOL



## X-ON Electronics

Largest Supplier of Electrical and Electronic Components

*Click to view similar products for [Pushbutton Switches](#) category:*

*Click to view products by [E-Switch](#) manufacturer:*

Other Similar products are found below :

[8940K2012](#) [LW1L-M1C10V-A](#) [LW1L-M1C70-A](#) [LW2L-A1C20M-GD](#) [LW2L-M1C20M-A](#) [60324L](#) [M22-D-R-GB0/K11](#) [M7E-HRN2](#)  
[67021K512](#) [67081K512X](#) [701PB580](#) [7190K101](#) [7199K101](#) [810K12910](#) [810KSV30B](#) [MML21EA2ADK](#) [MML21KA3ABK](#)  
[MML23KA3AC05K-001](#) [MML23KW3AA01W](#) [8418K2](#) [8442K3](#) [8450K1](#) [860K11911T01A](#) [861901](#) [861K11911T01A07](#)  
[861K13810T00A14](#) [861K13911](#) [8646AB6X718UL](#) [8646ABUL](#) [9001KXRK](#) [907AYY100](#) [PMHD155A1](#) [95-313.000](#)  
[9533CD4+U574+U4922](#) [95-414.000](#) [99-450.837](#) [99-453.837](#) [PV3H2B0NN-341](#) [1203MRA](#) [A22NZBGANGA](#) [A22NZBMMNGA](#)  
[A22NZBNANGA](#) [A22NZMPATRA](#) [A2PMA1X03EC56](#) [A3A-5123-02](#) [A3A-7140](#) [A3A-7310](#) [A3A-7340](#) [A3U-TMW-A2C-5M](#) [A595](#)