



SWITCH FUNCTION	
POS. 1	POS. 2
	
OFF	(ON)
OPEN	1-2

(ON) = MOMENTARY



PANEL CUTOUT  
MAX. PANEL THICKNESS 6.0mm

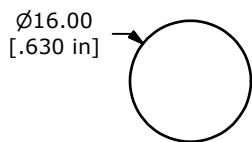
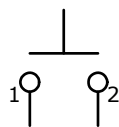

CIRCUIT: SPST

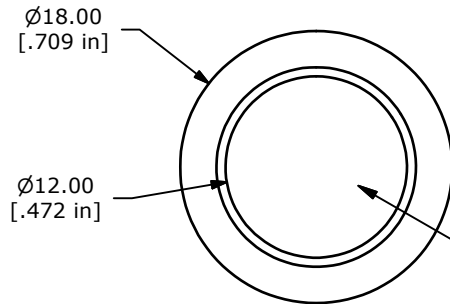

DOMED ACTUATOR  
NICKEL PLATED FINISH

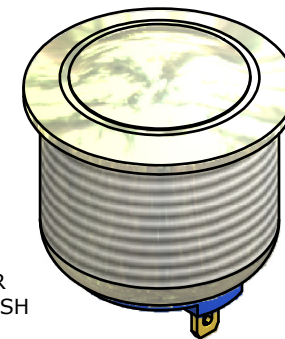

BODY FINISH  
NICKEL PLATED FINISH

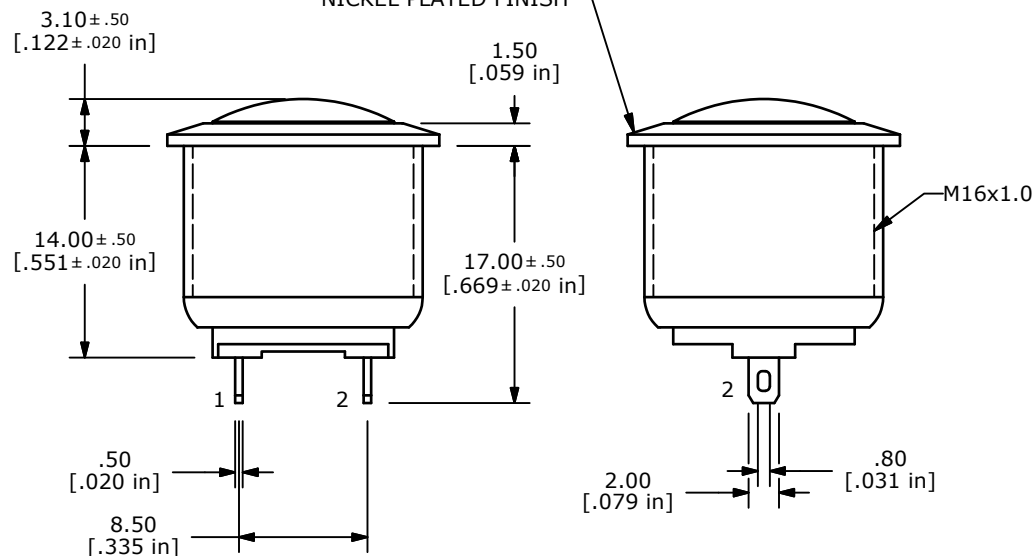

NOTE:

1. ALL DIMENSIONS IN MM [INCH]
2. GENERAL TOLERANCE: X.X=±0.4  
X.XX=±0.25
3. TERMINAL NUMBERS FOR REF ONLY
4. CONTACT MATERIAL: SILVER
5. RATING: 2A 48VDC
- ▲ 6. TRAVEL: 1.5 ± 0.2mm
7. ELECTRIC LIFE: 200,000 MAKE-AND-BREAK CYCLES
8. INSULATION RESISTANCE: 1,000 MΩ MIN.
9. DIELECTRIC STRENGTH: 2,000 VAC MIN. FOR 1 MINUTE
10. CONTACT RESISTANCE: 50mΩ MAX. @ 1A 12VDC
11. OPERATING TEMP.: -20°C to 55°C
12. ▲ DENOTES CRITICAL PARAMETER.
13. INGRESS PROTECTION: IP65
- ▲ 14. HARDWARE SUPPLIED: O-RING AND HEXNUT
15. 2002/95/EC (ROHS) COMPLIANT



C	20368	REVISED AND REDRAWN	12/29/11	BGL
REV	PCR NO	DESCRIPTION	DATE	BY

TITLE PV2S240NN				
SCALE	DATE	DR	DWG	REV
2:1	12/29/2011	BGL	52-PV2S240NN	C

THE INFORMATION CONTAINED IN THIS DOCUMENT IS PROPRIETARY TO E-SWITCH AND IS NOT TO BE COPIED OR TRANSFERRED

## X-ON Electronics

Largest Supplier of Electrical and Electronic Components

*Click to view similar products for [Pushbutton Switches](#) category:*

*Click to view products by [E-Switch](#) manufacturer:*

Other Similar products are found below :

[8940K2012](#) [LW1L-M1C10V-A](#) [LW1L-M1C70-A](#) [LW2L-A1C20M-GD](#) [LW2L-M1C20M-A](#) [60324L](#) [M22-D-R-GB0/K11](#) [M7E-HRN2](#)  
[67021K512](#) [67081K512X](#) [701PB580](#) [7190K101](#) [7199K101](#) [810K12910](#) [810KSV30B](#) [MML21EA2ADK](#) [MML21KA3ABK](#)  
[MML23KA3AC05K-001](#) [MML23KW3AA01W](#) [8418K2](#) [8442K3](#) [8450K1](#) [860K11911T01A](#) [861901](#) [861K11911T01A07](#)  
[861K13810T00A14](#) [861K13911](#) [8646AB6X718UL](#) [8646ABUL](#) [9001KXRK](#) [907AYY100](#) [PMHD155A1](#) [95-313.000](#)  
[9533CD4+U574+U4922](#) [95-414.000](#) [99-450.837](#) [99-453.837](#) [PV3H2B0NN-341](#) [1203MRA](#) [A22NZBGANGA](#) [A22NZBMMNGA](#)  
[A22NZBNANGA](#) [A22NZMPATRA](#) [A2PMA1X03EC56](#) [A3A-5123-02](#) [A3A-7140](#) [A3A-7310](#) [A3A-7340](#) [A3U-TMW-A2C-5M](#) [A595](#)