

**SCHEMATIC**

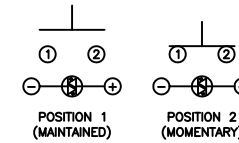

**SPECIFICATIONS**

**FUNCTION:**  
1P1T OFF-(ON)

**RATING:**  
2A 48VDC

**ILLUMINATION VOLTAGE:**  
2.8V 20mA

**CONTACT RESISTANCE:**  
Initial: 50mΩ Max. at 1A 12VDC

**INSULATION RESISTANCE:**  
1,000MΩ Min. at 500VDC

**DIELECTRIC STRENGTH:**  
2,000VAC Min. for 1 Minute

**ELECTRICAL LIFE:**  
200,000 Cycles

**MECHANICAL LIFE:**  
1,000,000 Cycles

**INGRESS PROTECTION:**  
IP65

**TEMPERATURE:**  
Operating: -20°C to 70°C

**APPROVALS:**  
**RoHS**  
COMPLIANT

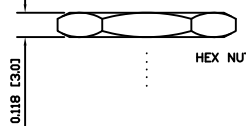
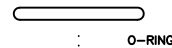
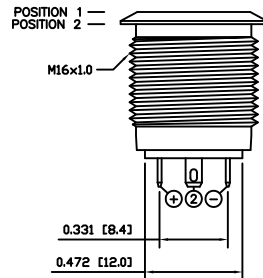
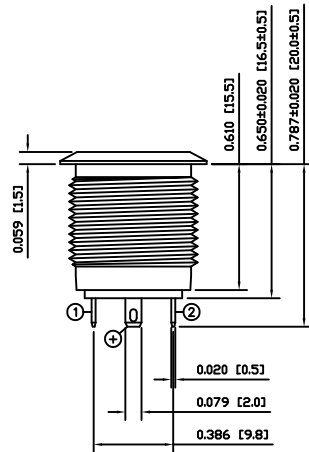
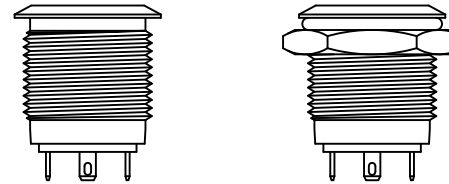
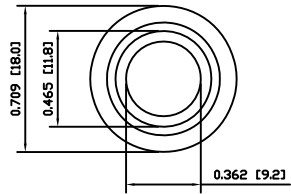

**EXPLODED VIEW**

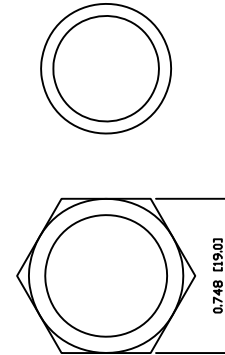

**ASSEMBLED VIEW**

**COLORS AND FINISH**

**BODY:**  
Stainless Steel  
Machine Finish

**ACTUATOR:**  
Stainless Steel  
Machine Finish

**ILLUMINATION:**  
White (Forward)  
White (Reverse)

**MATERIALS**

**BUSHING:**  
Stainless Steel (304)

**BASE:**  
Polybutylene Terephthalate (PBT), UL94 V-2

**ACTUATOR:**  
Stainless Steel (304)  
Polycarbonate (PC)

**HARDWARE:**  
Nickel Plated Brass (H59)

**SEALING:**  
Silicone Rubber

**SPRING:**  
Stainless Steel (304)

**CONTACTS:**  
Silver Alloy Plated Copper (AgCdO)

**TERMINALS:**  
Brass (H62)

**O-RING:**  
Silicone Rubber

**SUGGESTED PANEL CUTOUT**

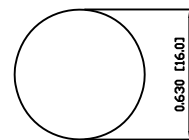

MAXIMUM PANEL THICKNESS: 0.315 [8.0mm]

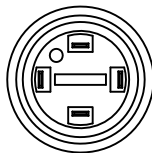

BODY	A	09/06/03	CAB
COLORS	A	09/06/03	CAB
MATERIALS	B	09/10/26	CAB
SPECIFICATIONS	A	09/06/03	CAB
REFERENCE	REV.	DATE	BY

THE INFORMATION CONTAINED IN THIS DOCUMENT IS PROPRIETARY TO E-SWITCH AND IS NOT TO BE COPIED OR TRANSFERRED

A	INITIAL RELEASE	19863	11/02/08	CAB
REV.	DESCRIPTION	PCR	DATE	DRAWN BY

DIMENSIONS	
INCHES [MILLIMETERS]	
GENERAL TOLERANCES	
±0.008 [±0.2] / ±1°	
SCALE	PROJECTION
DRAWING NOT TO SCALE	1st Angle

TITLE			
PV6F240SS-301			
SCALE	ITEM NUMBER	DATE	REVISION
DRAWING NOT TO SCALE	52-PV6F240SS301	FEBRUARY 2, 2011	A

## X-ON Electronics

Largest Supplier of Electrical and Electronic Components

*Click to view similar products for [Pushbutton Switches](#) category:*

*Click to view products by [E-Switch](#) manufacturer:*

Other Similar products are found below :

[8940K2012](#) [LW1L-M1C10V-A](#) [LW1L-M1C70-A](#) [LW2L-A1C20M-GD](#) [LW2L-M1C20M-A](#) [60324L](#) [M22-D-R-GB0/K11](#) [M7E-HRN2](#)  
[67021K512](#) [67081K512X](#) [701PB580](#) [7190K101](#) [7199K101](#) [810K12910](#) [810KSV30B](#) [MML21EA2ADK](#) [MML21KA3ABK](#)  
[MML23KA3AC05K-001](#) [MML23KW3AA01W](#) [8418K2](#) [8442K3](#) [8450K1](#) [860K11911T01A](#) [861901](#) [861K11911T01A07](#)  
[861K13810T00A14](#) [861K13911](#) [8646AB6X718UL](#) [8646ABUL](#) [9001KXRK](#) [907AYY100](#) [PMHD155A1](#) [95-313.000](#)  
[9533CD4+U574+U4922](#) [95-414.000](#) [99-450.837](#) [99-453.837](#) [PV3H2B0NN-341](#) [1203MRA](#) [A22NZBGANGA](#) [A22NZBMMNGA](#)  
[A22NZBNANGA](#) [A22NZMPATRA](#) [A2PMA1X03EC56](#) [A3A-5123-02](#) [A3A-7140](#) [A3A-7310](#) [A3A-7340](#) [A3U-TMW-A2C-5M](#) [A595](#)