

SCHEMATIC

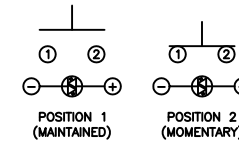

SPECIFICATIONS

FUNCTION:
1P1T OFF-(ON)

RATING:
2A 48VDC

ILLUMINATION VOLTAGE:
2.8V 20mA

CONTACT RESISTANCE:
Initial: 50mΩ Max. at 1A 12VDC

INSULATION RESISTANCE:
1,000MΩ Min. at 500VDC

DIELECTRIC STRENGTH:
2,000VAC Min. for 1 Minute

ELECTRICAL LIFE:
200,000 Cycles

MECHANICAL LIFE:
1,000,000 Cycles

INGRESS PROTECTION:
IP65

TEMPERATURE:
Operating: -20°C to 70°C

APPROVALS:
RoHS
COMPLIANT

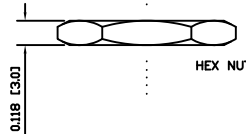
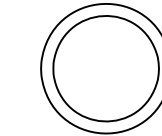
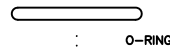
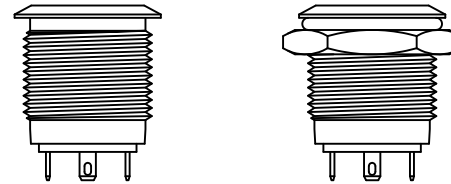
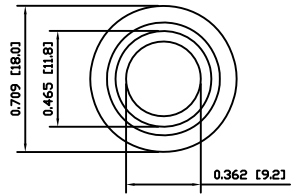

EXPLODED VIEW

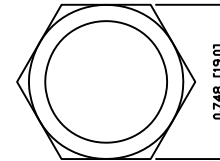

ASSEMBLED VIEW

COLORS AND FINISH

BODY:
Nickel
Plated Finish

ACTUATOR:
Nickel
Plated Finish

ILLUMINATION:
Blue (Forward)
Blue (Reverse)

MATERIALS

BUSHING:
Stainless Steel (304)

BASE:
Polybutylene Terephthalate (PBT), UL94 V-2

ACTUATOR:
Stainless Steel (304)
Polycarbonate (PC)

HARDWARE:
Nickel Plated Brass (H59)

SEALING:
Silicone Rubber

SPRING:
Stainless Steel (304)

CONTACTS:
Silver Alloy Plated Copper (AgCdO)

TERMINALS:
Brass (H62)

O-RING:
Silicone Rubber

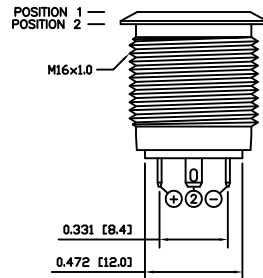
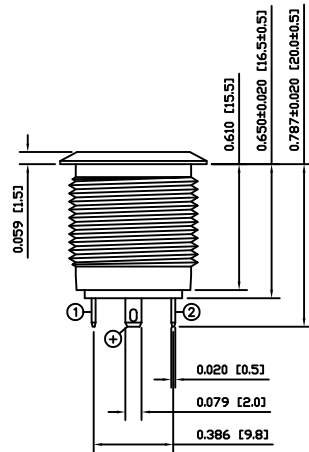

SUGGESTED PANEL CUTOUT

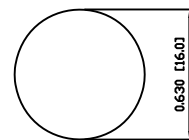

MAXIMUM PANEL THICKNESS: 0.315 [8.0mm]

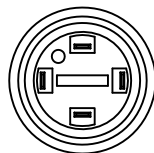

BODY	A	09/08/03	CAB
COLORS	A	09/08/12	CAB
MATERIALS	B	09/10/26	CAB
SPECIFICATIONS	A	09/08/03	CAB
REFERENCE	REV.	DATE	BY

THE INFORMATION CONTAINED IN THIS DOCUMENT IS PROPRIETARY TO E-SWITCH AND IS NOT TO BE COPIED OR TRANSFERRED

B	CORRECTED MATERIALS	PCRD0167	09/10/28	CAB
A	INITIAL RELEASE	PCRD0051	09/08/05	CAB
REV.	DESCRIPTION	PCR	DATE	DRAWN BY

DIMENSIONS	
INCHES [MILLIMETERS]	
GENERAL TOLERANCES	
±0.008 [±0.2] / ±1'	
SCALE	PROJECTION
DRAWING NOT TO SCALE	1st Angle

PV6F240SS-341		
DRAWING NUMBER	DATE	REVISION
52-PV6F240SS341	OCTOBER 28, 2009	B

X-ON Electronics

Largest Supplier of Electrical and Electronic Components

Click to view similar products for [Pushbutton Switches](#) category:

Click to view products by [E-Switch](#) manufacturer:

Other Similar products are found below :

[8940K2012](#) [LW1L-M1C10V-A](#) [LW1L-M1C70-A](#) [LW2L-A1C20M-GD](#) [LW2L-M1C20M-A](#) [60324L](#) [M22-D-R-GB0/K11](#) [M7E-HRN2](#)
[67021K512](#) [67081K512X](#) [701PB580](#) [7190K101](#) [7199K101](#) [810K12910](#) [810KSV30B](#) [MML21EA2ADK](#) [MML21KA3ABK](#)
[MML23KA3AC05K-001](#) [MML23KW3AA01W](#) [8418K2](#) [8442K3](#) [8450K1](#) [860K11911T01A](#) [861901](#) [861K11911T01A07](#)
[861K13810T00A14](#) [861K13911](#) [8646AB6X718UL](#) [8646ABUL](#) [9001KXRK](#) [907AYY100](#) [PMHD155A1](#) [95-313.000](#)
[9533CD4+U574+U4922](#) [95-414.000](#) [99-450.837](#) [99-453.837](#) [PV3H2B0NN-341](#) [1203MRA](#) [A22NZBGANGA](#) [A22NZBMMNGA](#)
[A22NZBNANGA](#) [A22NZMPATRA](#) [A2PMA1X03EC56](#) [A3A-5123-02](#) [A3A-7140](#) [A3A-7310](#) [A3A-7340](#) [A3U-TMW-A2C-5M](#) [A595](#)